

PLEASE CHECK WWW.MOLEX.COM FOR LATEST PART INFORMATION

Part Number: [0436500413](#)
Status: **Active**
Overview: [microfit_30](#)
Description: 3.00mm (.118") Pitch Micro-Fit 3.0™ Header, Surface Mount Compatible, Single Row, Right Angle, with Solder Tab, 4 Circuits, 0.38µm (15µ") Gold (Au) Selective Plating, Glow Wire Compatible

Documents:

[3D Model](#) [Product Specification PS-43650 \(PDF\)](#)
[Drawing \(PDF\)](#) [RoHS Certificate of Compliance \(PDF\)](#)

Agency Certification

CSA	LR19980
TUV	R72081037
UL	E29179

General

Product Family	PCB Headers
Series	43650
Application	Wire-to-Board
Comments	Glow Wire Equivalent Part Number 436500413 . High Temperature, Square Pin, Solder Type
Overview	microfit_30
Product Literature Order No	USA-106
Product Name	Micro-Fit 3.0™

Physical

Breakaway	No
Circuits (Loaded)	4
Circuits (maximum)	4
Color - Resin	Black
Durability (mating cycles max)	30
Flammability	94V-0
Glow-Wire Compliant	Yes
Mated Height (in)	0.275 In
Mated Height (mm)	6.98 mm
Material - Metal	Brass
Material - Plating Mating	Gold
Material - Plating Termination	Tin
Material - Resin	High Temperature Thermoplastic
Number of Rows	1
Orientation	Right Angle
PCB Locator	Yes
PCB Retention	Yes
PCB Thickness Recommended (in)	0.062 In
PCB Thickness Recommended (mm)	1.60 mm
Packaging Type	Embossed Tape on Reel
Pitch - Mating Interface (in)	0.118 In
Pitch - Mating Interface (mm)	3.00 mm
Plating min: Mating (µin)	15
Plating min: Mating (µm)	0.38
Plating min: Termination (µin)	100
Plating min: Termination (µm)	2.50
Polarized to PCB	Yes
Shrouded	Fully
Stackable	No

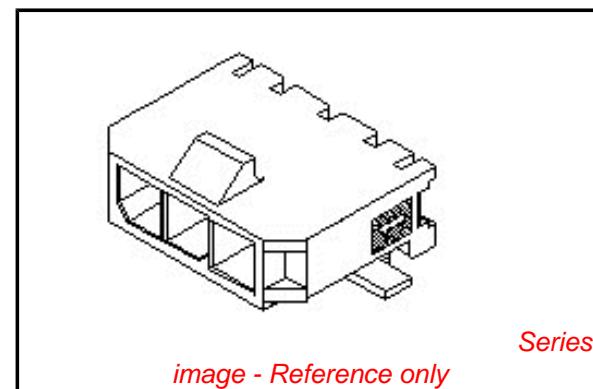

EU RoHS

ELV and RoHS Compliant
REACH SVHC Contains SVHC: No
Halogen-Free Status

China RoHS



Need more information on product environmental compliance?

Email productcompliance@molex.com
 For a multiple part number RoHS Certificate of Compliance, [click here](#)

Please visit the [Contact Us](#) section for any non-product compliance questions.

Search Parts in this Series

[43650Series](#)

Mates With

[43645 Micro-Fit 3.0™ Receptacle Housing](#)

Temperature Range - Operating	-40°C to +105°C
Termination Interface: Style	Surface Mount

Electrical

Current - Maximum per Contact	5A
Voltage - Maximum	250V

Solder Process Data

Duration at Max. Process Temperature (seconds)	30
Lead-free Process Capability	Reflow Capable (SMT only)
Max. Cycles at Max. Process Temperature	3
Process Temperature max. C	260

Material Info

Reference - Drawing Numbers

Packaging Specification	PK-70873-07**
Product Specification	PS-43650
Sales Drawing	SD-43650-005
Test Summary	TS-43045-002

This document was generated on 05/24/2010

PLEASE CHECK WWW.MOLEX.COM FOR LATEST PART INFORMATION

13 12 11 10 9 8 7 6 5 4 3 2 1

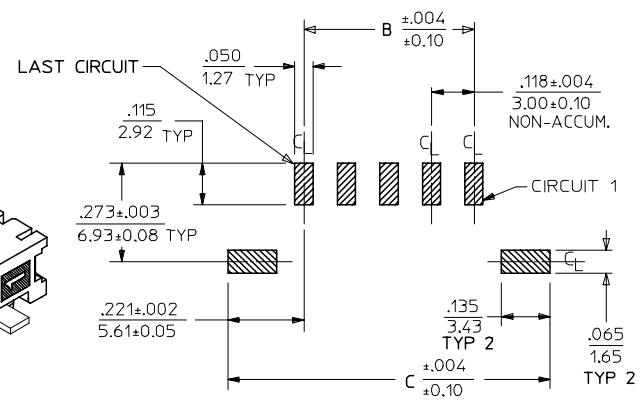
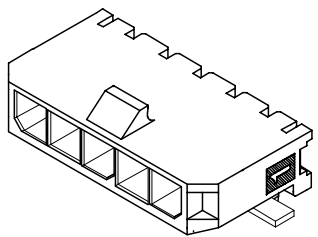
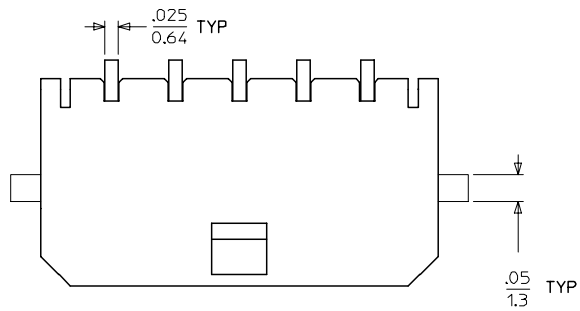

CKTS	A	B	C
2	.380 9.65	.118 3.00	.559 14.20
3	.498 12.65	.236 6.00	.677 17.20
4	.616 15.65	.354 9.00	.795 20.20
5	.734 18.64	.472 12.00	.913 23.20
6	.852 21.64	.591 15.00	1.031 26.20
7	.970 24.64	.709 18.00	1.150 29.20
8	1.088 27.64	.827 21.00	1.268 32.20
9	1.206 30.63	.945 24.00	1.386 35.20
10	1.325 33.66	1.063 27.00	1.504 38.20
11	1.443 36.65	1.181 30.00	1.622 41.20
12	1.561 39.65	1.299 33.00	1.740 44.20

PCB LAYOUT: COMPONENT SIDE

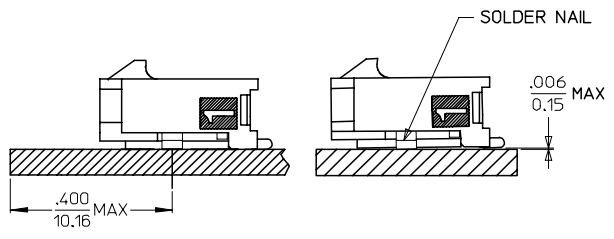
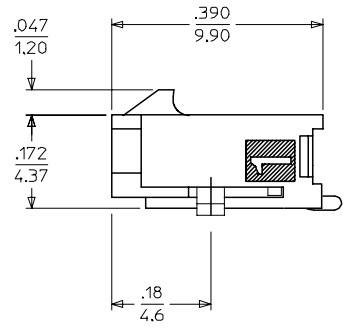
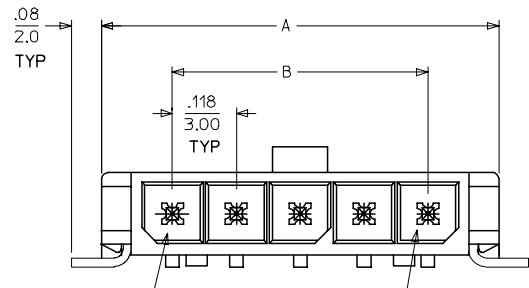

LOCATION DETAIL
SEE NOTE #7

COPLANARITY DETAIL
SEE NOTE #6

NOTES:

CIRCUIT 1

- HOUSING MATERIAL: LIQUID CRYSTAL POLYMER, GLASS FILLED, UL94V-0, COLOR: BLACK
TERMINAL MATERIAL: BRASS ALLOY
- FINISH: A = .000100/(0.00254) MIN. BRIGHT TIN OVER .000050/(0.00127) MIN. NICKEL
B = .000015/(0.00038) MIN. SELECT GOLD IN CONTACT AREA .000100/(0.00254) MIN. SELECT MATTE TIN ON SOLDER TAILS BOTH OVER .000050/(0.00127) NICKEL OVERALL
C = .000030/(0.00076) MIN. SELECT GOLD IN CONTACT AREA .000100/(0.00254) MIN. SELECT MATTE TIN ON SOLDER TAILS BOTH OVER .000050/(0.00127) NICKEL OVERALL
- * THE PRIMARY SHIPPING CARTON WILL BE LABELED "COMPLIANT TO RoHS DIRECTIVE 2002/95/EC AND ELV ANNEX II OF DIRECTIVE 2000/53/EC." CARTONS WITHOUT THIS LABEL MAY CONTAIN PRODUCT WITH TIN/LEAD IN THE PC TAIL AREA.
- PRODUCT SPECIFICATION: PS-43650
- TAPE AND REEL PACKAGED : SEE MOLEX DRAWING PK-70873-07**
- MATES WITH MICRO FIT (3.0) RECEPTACLE SERIES 43645
- THE COPLANARITY DIMENSION IS ESTABLISHED BY PLACING THE ASSEMBLY ON A FLAT SURFACE. THE DISTANCE FROM THAT SURFACE TO THE BOTTOM OF ANY TERMINAL OR NAIL MUST NOT EXCEED .006/0.15
- TO AVOID INTERFERENCE BETWEEN RECEPTACLE AND PCB, HEADER MUST BE PLACED WITHIN .400/(10.16) MAX. FROM EDGE OF PCB, AS SHOWN IN LOCATION DETAIL.
- A HIGHER TEMPERATURE GRADE MATERIAL (260C MAX. REFLOW TEMPERATURE) IS BEING PHASED-IN BEGINNING AUGUST 2007. PARTS WILL BE TEMPORARILY IDENTIFIED WITH A BLUE DOT ON THE PRIMARY SHIPPING CARTON LABEL UNTIL ALL CIRCUIT SIZES ARE CONVERTED. AT WHICH TIME A FULL-CONVERSION DATE WILL BE IDENTIFIED IN PS-43650.

CKTS	FINISH A	FINISH B	FINISH C
	MATERIAL NO:	MATERIAL NO:	MATERIAL NO:
02	43650-0212	43650-0213	43650-0214
03	43650-0312	43650-0313	43650-0314
04	43650-0412	43650-0413	43650-0414
05	43650-0512	43650-0513	43650-0514
06	43650-0612	43650-0613	43650-0614
07	43650-0712	43650-0713	43650-0714
08	43650-0812	43650-0813	43650-0814
09	43650-0912	43650-0913	43650-0914
10	43650-1012	43650-1013	43650-1014
11	43650-1112	43650-1113	43650-1114
12	43650-1212	43650-1213	43650-1214

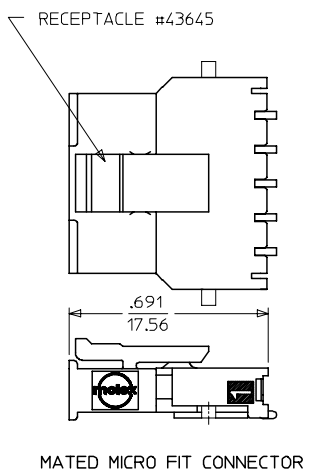

MATED MICRO FIT CONNECTOR

ADD NOTES 7 AND 8 EC NO: UCP2008-0037 DRAWN: MK/PPER 2007/09/06 CHKD: SSOUSEK 2007/09/11 APPR: FSM/TH 2007/09/12	QUALITY SYMBOLS ▽=0 ▽=0	GENERAL TOLERANCES (UNLESS SPECIFIED) mm INCH 4 PLACES ± --- ± --- 3 PLACES ± --- ± .010 2 PLACES ± 0.25 ± .014 1 PLACE ± 0.36 ± --- ANGULAR ±1/2°	DIMENSION STYLE IN/MM DRAWN BY: SAMIEC DATE: 2000/07/07 CHECKED BY: MUELLER DATE: 2000/07/07 APPROVED BY: EDGLEY DATE: 2000/07/07	SCALE: --- DESIGN UNITS: METRIC THIRD ANGLE PROJECTION	MICRO FIT (3.0) SINGLE ROW / RIGHT ANGLE SMT / NAILS / REELS MOLEX INCORPORATED	MATERIAL NO. DOCUMENT NO. SD-43650-005 SHEET NO. 1 OF 1	
	DRAFT WHERE APPLICABLE MUST REMAIN WITHIN DIMENSIONS		SEE CHART		THIS DRAWING CONTAINS INFORMATION THAT IS PROPRIETARY TO MOLEX INCORPORATED AND SHOULD NOT BE USED WITHOUT WRITTEN PERMISSION		
	MOLEX INCORPORATED						
	DRAWING NO. SD-43650-005						

12 11 10 9 8 7 6 5 4 3 2 1