

**PLEASE CHECK WWW.MOLEX.COM FOR LATEST PART INFORMATION**

**Part Number:** [0524180710](#)  
**Status:** **Active**  
**Description:** 2.00mm (.079") Pitch Board-to-Board Receptacle, Right Angle, Single Row, Friction Lock, 7 Circuits

**Documents:**

[3D Model](#)  
[Drawing \(PDF\)](#)  
[Product Specification PS-52418-002 \(PDF\)](#)  
[Product Specification PS-52418-003 \(PDF\)](#)  
[RoHS Certificate of Compliance \(PDF\)](#)

**General**

Product Family PCB Receptacles  
 Series [52418](#)  
 Application Board-to-Board  
 Product Name N/A

**Physical**

Circuits (Loaded) 7  
 Color - Resin Natural  
 Durability (mating cycles max) 30  
 Glow-Wire Compliant No  
 Material - Metal Phosphor Bronze  
 Material - Plating Mating Tin  
 Material - Plating Termination Tin  
 Material - Resin Polyester  
 Number of Rows 1  
 Orientation Right Angle  
 PCB Locator No  
 PCB Retention Yes  
 PCB Thickness Recommended (in) 0.062 In  
 PCB Thickness Recommended (mm) 1.60 mm  
 Packaging Type Tray  
 Pitch - Mating Interface (in) 0.079 In  
 Pitch - Mating Interface (mm) 2.00 mm  
 Plating min: Mating (µin) 36  
 Plating min: Mating (µm) 0.90  
 Plating min: Termination (µin) 36  
 Plating min: Termination (µm) 0.90  
 Polarized to PCB No  
 Surface Mount Compatible (SMC) No  
 Temperature Range - Operating -40°C to +105°C  
 Termination Interface: Style Through Hole - Kinked Pin

**Electrical**

Current - Maximum per Contact 1.5A  
 Voltage - Maximum 125V

**Material Info**

**Reference - Drawing Numbers**

Product Specification PS-52418-002, PS-52418-003, RPS-52418-001, RPS-52418-004  
 Sales Drawing SD-52418-\*\*10

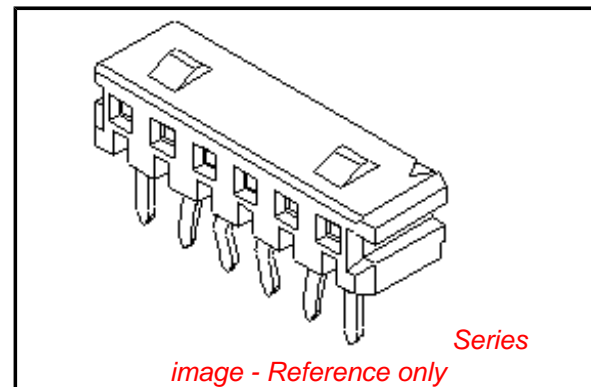

**EU RoHS**

**ELV and RoHS Compliant**  
**REACH SVHC**  
 Not Reviewed  
**Halogen-Free Status**

**China RoHS**



**Need more information on product environmental compliance?**

Email [productcompliance@molex.com](mailto:productcompliance@molex.com)  
 For a multiple part number RoHS Certificate of Compliance, [click here](#)

Please visit the [Contact Us](#) section for any non-product compliance questions.

**Search Parts in this Series**

[52418Series](#)

**Mates With**

[53290](#)

**PLEASE CHECK [WWW.MOLEX.COM](http://WWW.MOLEX.COM) FOR LATEST PART INFORMATION**

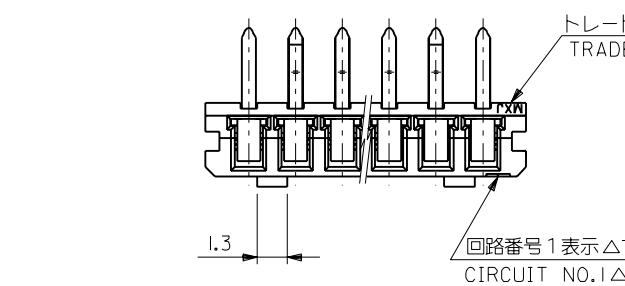
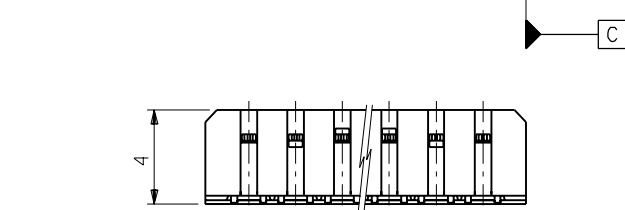
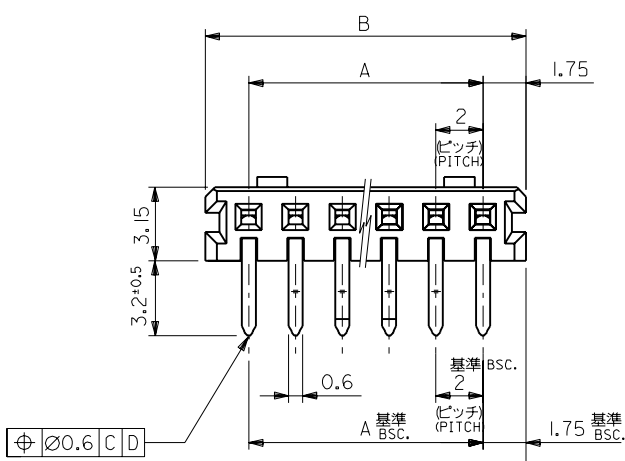

注記 NOTES

- 材料 MATERIAL  
ハウジング: PBT (ガラス15%入り), UL 94V-0  
HOUSING G.F. 15%  
ターミナル: リン青銅, 錫メッキ  
TERMINAL PHOS.BRO. PRE-TINNED
- 嵌合相手: 53290-\*\*\*10, -\*\*\*20  
MATES WITH
- 各部のソリは0.2MAX.  
CAMBER: 0.2MAX.  
キックは、下記表の位置に付加。  
KINK TO BE APPLIED AS FOLLOWS.  
(N: 極数 CKT.)

極数 CKT.	回路番号 Ckt. No.	1	2	3	4	5	N-2	N-1	N
6極以上 MORE THAN 6 CKT.		-	a	b	-	-	b	a	-
5極 5 CKT.		a	b	-	b	a			
4極 4 CKT.		a	b	b	a				
3極 3 CKT.		a	b	a					

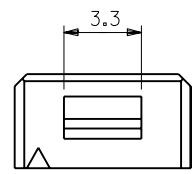
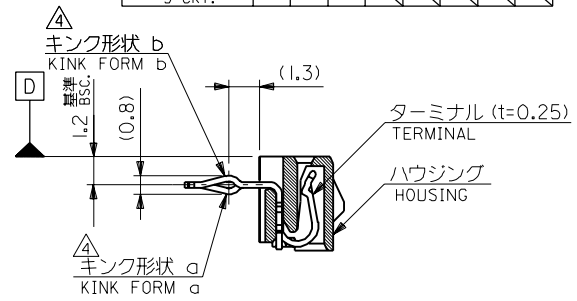

3極の場合  
IN CASE OF  
3 CIRCUIT HOUSING

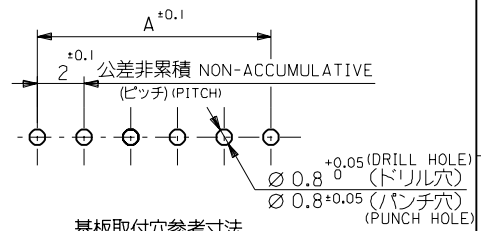

基板取付穴参考寸法  
RECOMMENDED P.C.B. BOARD  
HOLE DIM.(REFERENCE)  
(t = 1.6)

41.5	38	52418-2010	20
39.5	36	-1910	19
37.5	34	-1810	18
35.5	32	-1710	17
33.5	30	-1610	16
31.5	28	-1510	15
29.5	26	-1410	14
27.5	24	-1310	13
25.5	22	-1210	12
23.5	20	-1110	11
21.5	18	-1010	10
19.5	16	-0910	9
17.5	14	-0810	8
15.5	12	-0710	7
13.5	10	-0610	6
11.5	8	-0510	5
9.5	6	-0410	4
7.5	4	52418-0310	3
	B	A	極数 CKT.

角度 ANGLE	変更 REVISD	変更 REVISD	変更 REVISD	変更 REVISD	記号 LTR	変更内容 REVISION RECORD	DR. CHK.	日付 DATE
30以上 OVER	+3°	B	変更 REVISD (J10812)	T.I.				'93/9/23
10以上 30未満 OVER	+0.3	A	変更 REVISD (J00866)	T.I.				'90/8/21
10未満 UNDER	+0.25	O	新規作成 RELEASED (J00558)	S.A.				'90/7/12
一般公差 GENERAL TOLERANCES	+0.2							

材料 MATERIAL	注記参照 SEE NOTES
仕上げ FINISH	— / —
適用電線範囲 WIRE RANGE	— / —
被覆外径 INS. RANGE	— / —
DRAWN BY '90/7/11	CHK'D BY '93/9/23
S. AIHARA	T. ITO
APP'D BY '93/9/23	尺度 SCALE
M. FUKUSHIMA	— / —

MOLEX JAPAN CO., LTD. 日本モレックス株式会社	
EDP NO.	REV C
ENG. NO. SD-52418-***10	TITLE 名称 2.0 BOARD TO BOARD CONN. HOUSING ASS'Y (R/A)