

#### POWER MANAGEMENT

#### Features

- $V_{IN}$  Range: 2.9 – 5.5V
- $V_{OUT}$  Selectable: 0.8 - 3.3V
- Up to 1.8A Output Current for Each Channel
- Ultra-Small Footprint, <1mm Height Solution
- 2.5MHz Switching Frequency
- Efficiency Up to 93%
- Low Output Noise Across Load Range
- Excellent Transient Response
- Start Up into Pre-Bias Output
- 100% Duty-Cycle Low Dropout Operation
- <1 $\mu$ A Shutdown Current
- Internal Soft Start
- Input Under-Voltage Lockout
- Output Over-Voltage, Current Limit Protection
- Over-Temperature Protection
- Adjustable Output Voltage
- 2mm x 3mm x 0.8mm thermally enhanced MLPQ-W18 package
- -40 to +85°C Temperature Range
- Pb-Free product. RoHS/WEEE and Halogen Free compliant

#### Applications

- Desktop Computing
- Set-Top Box
- LCD TV
- Network Cards
- Printer

#### Typical Application Circuit

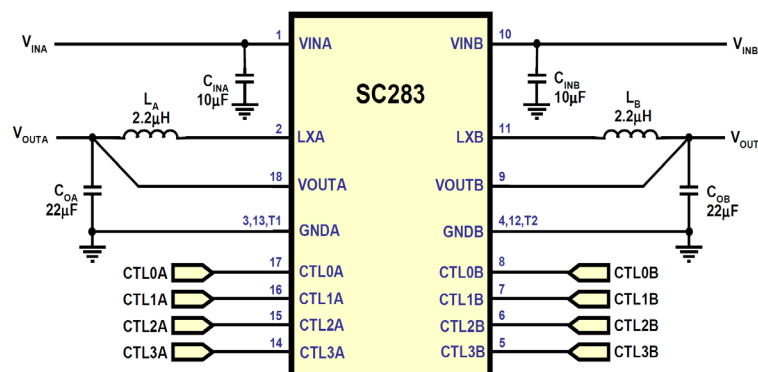

#### Description

The SC283 is a dual channel 1.8A synchronous step-down regulator designed to operate with an input voltage range of 2.9 to 5.5 Volts. Each channel offers fifteen pre-determined output voltages via four control pins programmable from 0.8 to 3.3 Volts. The control pins allow for on-the-fly voltage changes, enabling system designers to implement dynamic power savings. The SC283 is also capable of adjusting the output voltage via an external resistor divider.

The device operates with a fixed 2.5MHz oscillator frequency, allowing the use of small surface mount external components.

Connecting CTL0 — CTL3 to logic low forces the device into shutdown mode reducing the supply current to less than 1 $\mu$ A. Connecting any of the control pins to logic high enables the converter and sets the output voltage according to Table 1. Other features include under-voltage lockout, soft-start to limit inrush current, and over-temperature protection.

The SC283 is available in a thermally-enhanced, 2mm x 3mm x 0.8mm MLPQ-W18 package and has a rated temperature range of -40 to +85°C.

### Pin Configuration

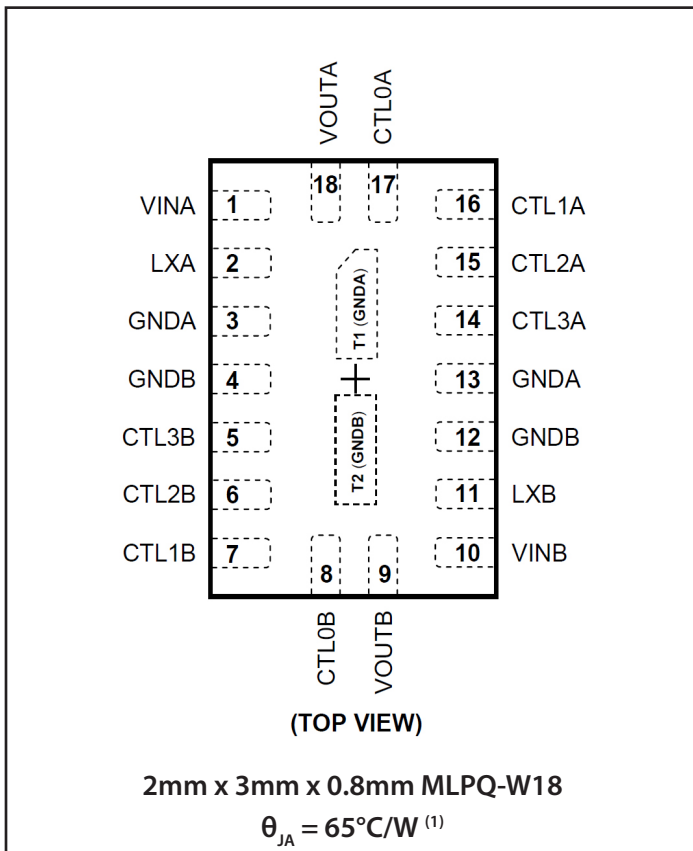

### Marking Information

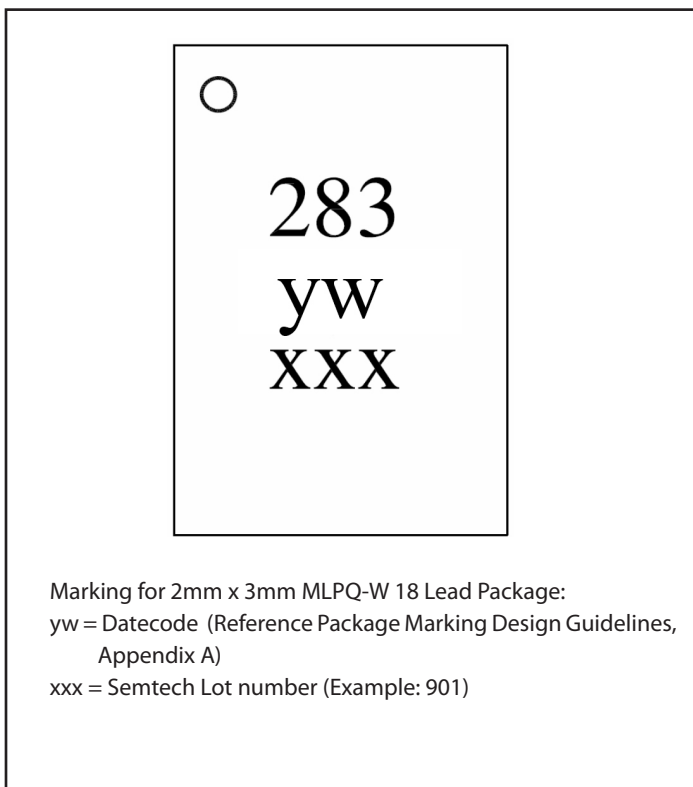

### Ordering Information

Device	Package
SC283WLTRT <sup>(2)(3)</sup>	2mm x 3mm x 0.8mm MLPQ-W18
SC283EVB <sup>(4)</sup>	Evaluation Board

Notes:

- (1) Calculated from package in still air, mounted to 3" x 4.5", 4 layer FR4 PCB with thermal vias under the exposed pad per JESD51 standards.
- (2) Available in tape and reel only. A reel contains 3,000 devices.
- (3) Pb-Free product. RoHS/WEEE and Halogen Free compliant.
- (4) Please specify the default VOUTA & VOUTB when ordering.

**Table 1 – Output Voltage Settings**

CTL3_	CTL2_	CTL1_	CTLO_	Output Voltage
0	0	0	0	Shutdown
0	0	0	1	0.80
0	0	1	0	1.00
0	0	1	1	1.025
0	1	0	0	1.05
0	1	0	1	1.20
0	1	1	0	1.25
0	1	1	1	1.30
1	0	0	0	1.50
1	0	0	1	1.80
1	0	1	0	2.20
1	0	1	1	2.50
1	1	0	0	2.60
1	1	0	1	2.80
1	1	1	0	3.00
1	1	1	1	3.30



## Absolute Maximum Ratings

VINA and VINB Supply Voltages	-0.3 to 6.0V
LXA, LXB Voltage	-1 to VIN+1V, -3V (20ns Max), 6V Max
VOUTA, VOUTB Voltage	-0.3 to VIN+0.3V
CTLxA/B pins Voltages	-0.3 to VIN+0.3V
Peak IR Reflow Temperature	260°C
ESD Protection Level <sup>(6)</sup>	3.5kV

## Recommended Operating Conditions

Supply Voltage VINA and VINB	2.9 to 5.5V
Maximum Output Current for each channel	1.8A
Temperature Range	-40 to +85°C

## Thermal Information

Thermal Resistance, Junction to Ambient <sup>(5)</sup>	65 °C/W
Maximum Junction Temperature	+150°C
Storage Temperature Range	-65 to +150 °C

Exceeding the absolute maximum ratings may result in permanent damage to the device and/or device malfunction. Operation outside of the parameters specified in the Electrical Characteristics section is not recommended.

Notes:

- (5) Calculated from package in still air, mounted to 3" x 4.5", 4 layer FR4 PCB with thermal vias under the exposed pad per JESD51 standards.  
 (6) Tested according to JEDEC standard JESD22-A114-B.

## Electrical Characteristics

Unless specified: VINA= VINB= 5.0V, VOUTA= VOUTB=1.50V, C<sub>INA</sub>=C<sub>INB</sub>=10μF, C<sub>OA</sub>=C<sub>OB</sub>= 22μF, L= 2.2μH, -40°C ≤ T<sub>J</sub> ≤ +125 °C. Unless otherwise noted typical values are T<sub>A</sub> = +25 °C.

Parameter	Symbol	Conditions	Min	Typ	Max	Units
Under-Voltage Lockout	UVLO	Rising VINA, VINB	2.65	2.75	2.85	V
		Hysteresis	240	300		mV
Output Voltage Tolerance <sup>(7)</sup>	ΔV <sub>OUT</sub>	Channel A & B; VIN= 2.9 – 5.5V; I <sub>OUT</sub> =0A	-2.0		+2.0	%
Current Limit	I <sub>LIMIT</sub>	Channel A & B; Peak LX current	2.25	3.0	3.75	A
Supply Current	I <sub>Q</sub>	Channel A & B; No load, Per channel		10		mA
Shutdown Current	I <sub>SHDN</sub>	CTL <sub>0-3</sub> = GND, Per channel		1	10	μA
High Side Switch Resistance <sup>(8)</sup>	R <sub>DSON_P</sub>	Channel A & B; I <sub>LX</sub> = 100mA, T <sub>J</sub> = 25 °C		95		mΩ
Low Side Switch Resistance <sup>(8)</sup>	R <sub>DSON_N</sub>	Channel A & B; I <sub>LX</sub> = -100mA, T <sub>J</sub> = 25 °C		65		
L <sub>X</sub> Leakage Current <sup>(8)</sup>	I <sub>LK(LX)</sub>	Channel A & B; VIN= 5.5V; LX= 0V; CTL <sub>0-3</sub> = GND		1	10	μA
		Channel A & B; VIN= 5.5V; LX= 5.0V; CTL <sub>0-3</sub> = GND	-10	-1		
Load Regulation	ΔV <sub>LOAD-REG</sub>	Channel A & B; VIN= 5.0V; I <sub>OUT</sub> =1mA – 1.8A		±0.5		%
Oscillator Frequency	f <sub>OSC</sub>	Channel A & B	2.125	2.500	2.875	MHz
Soft-Start Time	t <sub>SS</sub>	Channel A & B; I <sub>OUT</sub> = 1.8A		850		μs
Foldback Holding Current	I <sub>CL_HOLD</sub>	Average LX Current, VOUT=1.5V		240		mA
		Average LX Current, VOUT=3.3V		130		mA
CTLx Input Current <sup>(8)</sup>	I <sub>CTL</sub>	Channel A & B; CTL <sub>0-3</sub> =VIN or GND	-2.0		2.0	μA
CTLx Input High Threshold	V <sub>CTLX_HI</sub>	Channel A & B	1.2			V

**Electrical Characteristics (continued)**

Parameter	Symbol	Conditions	Min	Typ	Max	Units
CTLx Input Low Threshold	$V_{CTLx\_LO}$	Channel A & B			0.4	V
$V_{OUT}$ Over Voltage Protection	$V_{OVP}$	Channel A & B		115		%
Thermal Shutdown Temperature	$T_{SD}$	Channel A & B <sup>(9)</sup>		160		°C
Thermal Shutdown Hysteresis	$T_{SD\_HYS}$	Channel A & B <sup>(9)</sup>		10		°C

## Notes:

(7) The "Output Voltage Tolerance" includes output voltage accuracy, voltage drift over temperature and the line regulation.

(8) The negative current means the current flows into the pin and the positive current means the current flows out from the pin.

(9) The thermal shutdown for both Channel A and B is independent from each other.

## Typical Characteristics

Circuit Conditions:  $C_{IN} = 10\mu F/6.3V$ ;  $C_{OUT} = 22\mu F/6.3V$ , Unless otherwise noted,  $L = 2.2\mu H$  (TOKO: 1127AS-2R2M).

Efficiency vs. Load Current

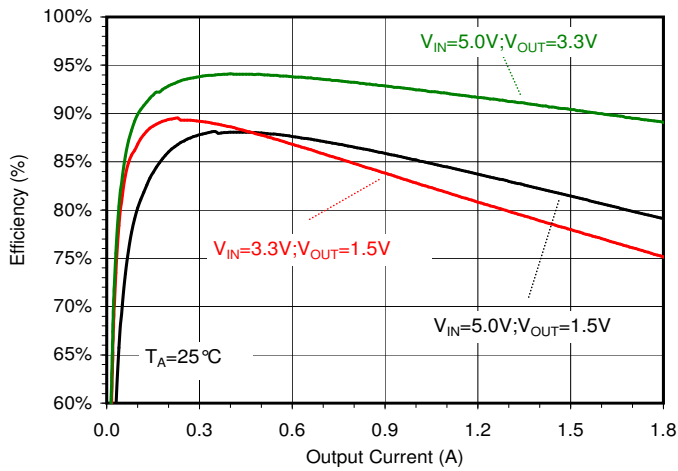

Total Loss (Per Channel) vs. Load Current

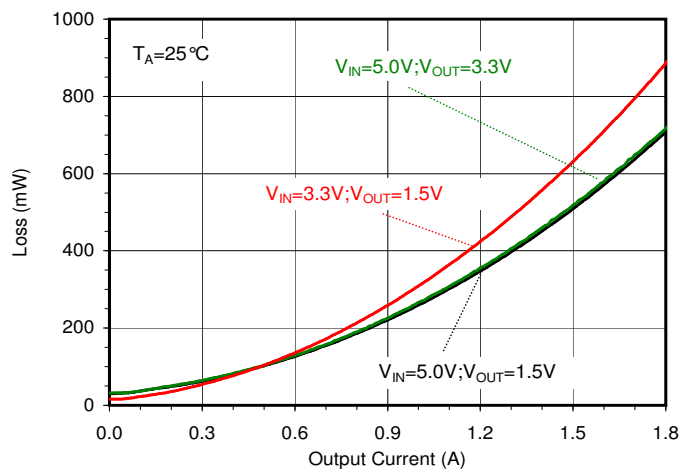

Load Regulation

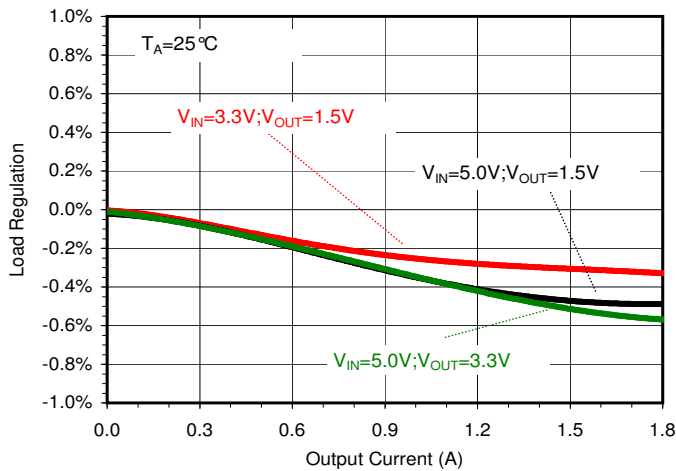

Dropout Voltage in 100% Duty Cycle Operation

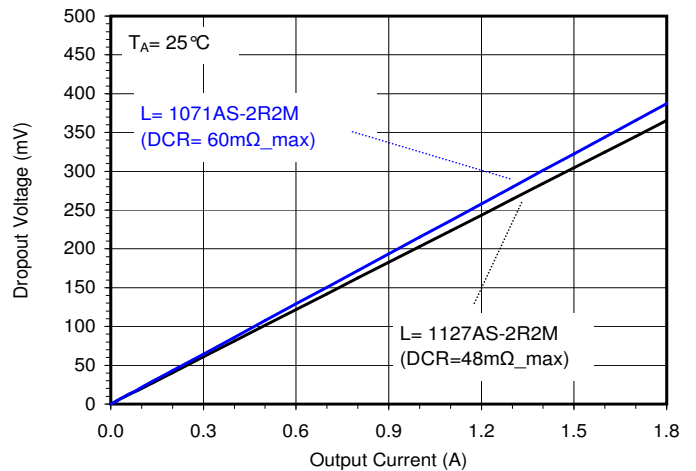

UVLO Rising Threshold Variation

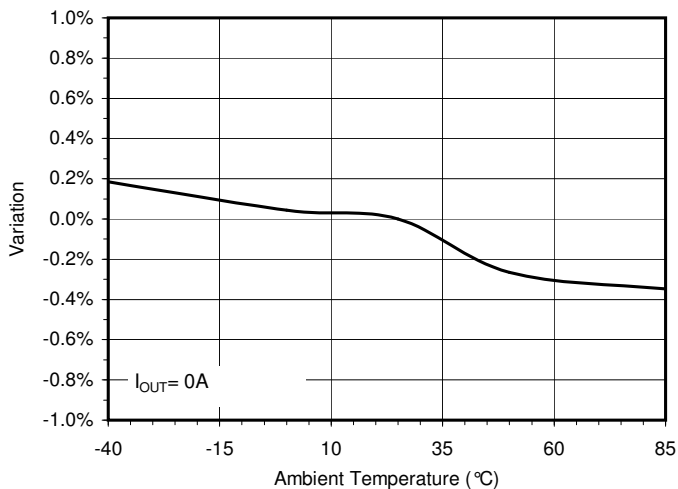

UVLO Hysteresis Variation

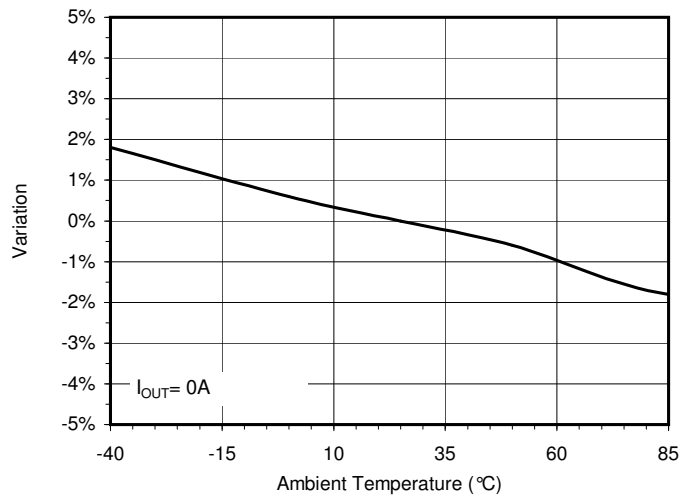



### Typical Characteristics (continued)

Circuit Conditions:  $C_{IN} = 10\mu F/6.3V$ ;  $C_{OUT} = 22\mu F/6.3V$ , Unless otherwise noted,  $L = 2.2\mu H$  (TOKO: 1127AS-2R2M).

$R_{DS(ON)}$  Variation vs. Input Voltage

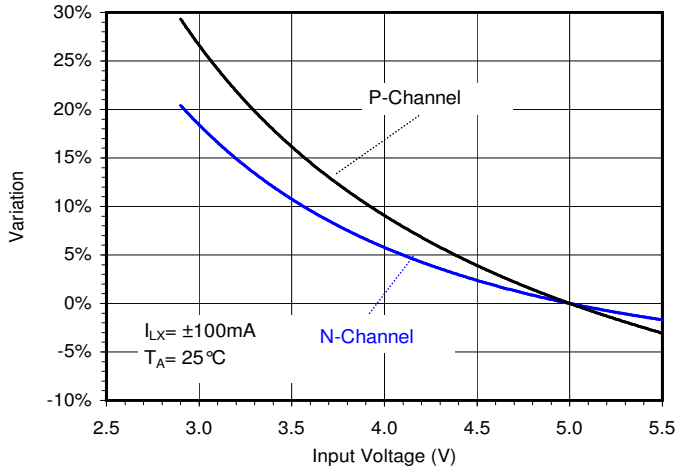

$R_{DS(ON)}$  Variation vs. Temperature

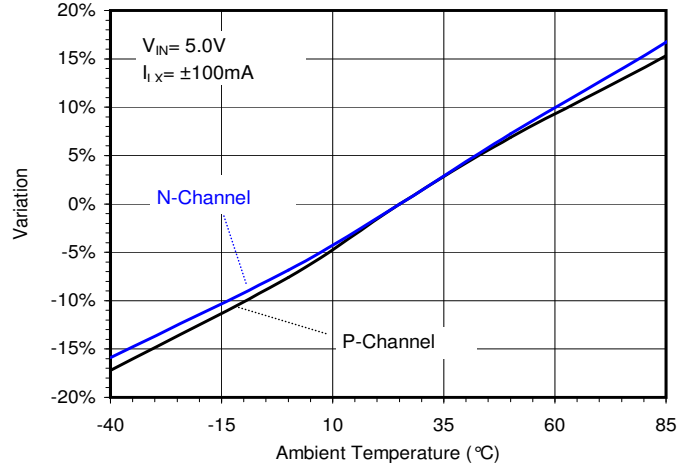

Switching Frequency Variation vs. Input Voltage

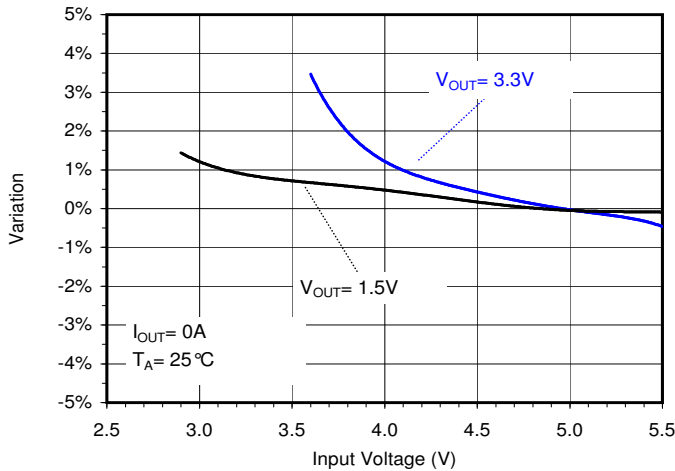

Switching Frequency Variation vs. Temperature

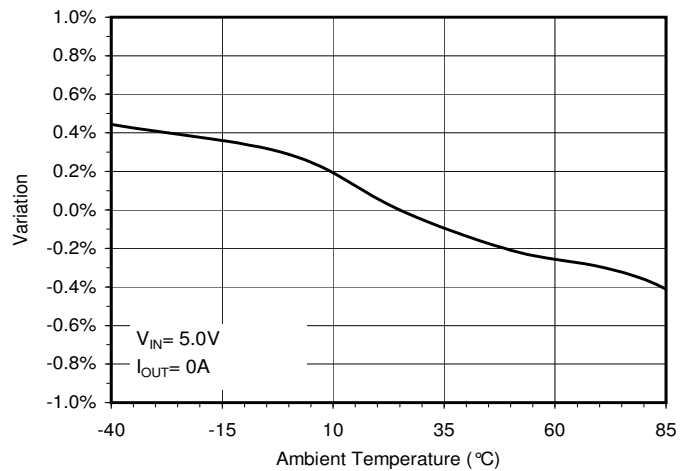

Line Regulation

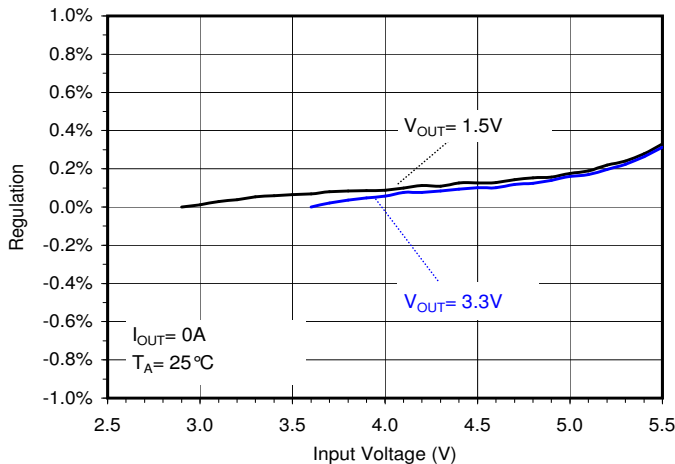

Line Regulation vs. Temperature

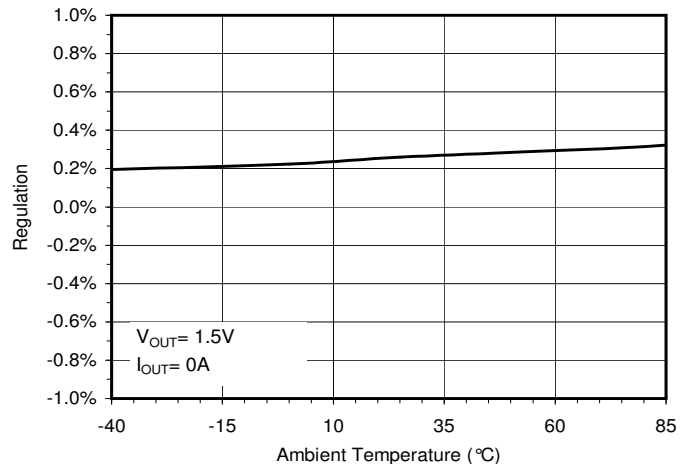

## Typical Waveforms

Circuit Conditions:  $C_{IN} = 10\mu F/6.3V$ ;  $C_{OUT} = 22\mu F/6.3V$ ,  $L = 2.2\mu H$  (TOKO: 1127AS-2R2M).

Output Voltage Ripple ( $V_{OUT} = 1.5V$ )

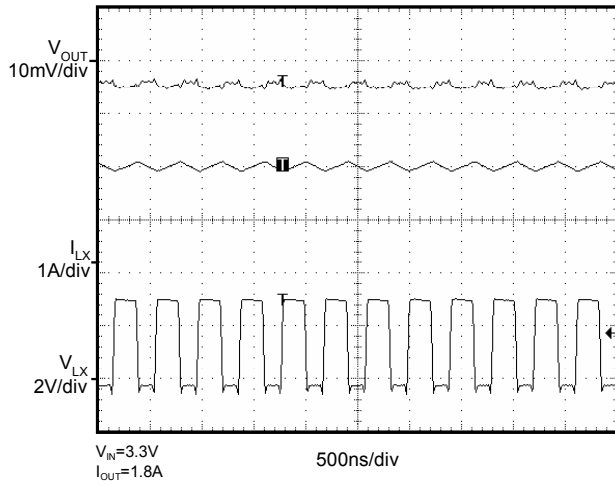

Output Voltage Ripple ( $V_{OUT} = 1.5V$ )

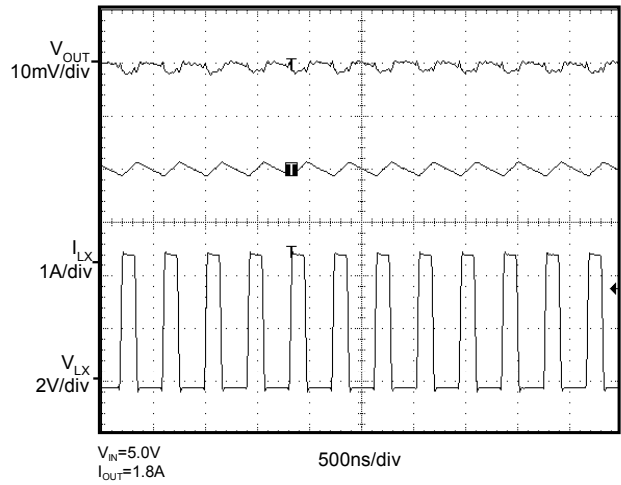

Output Voltage Ripple ( $V_{OUT} = 3.3V$ )

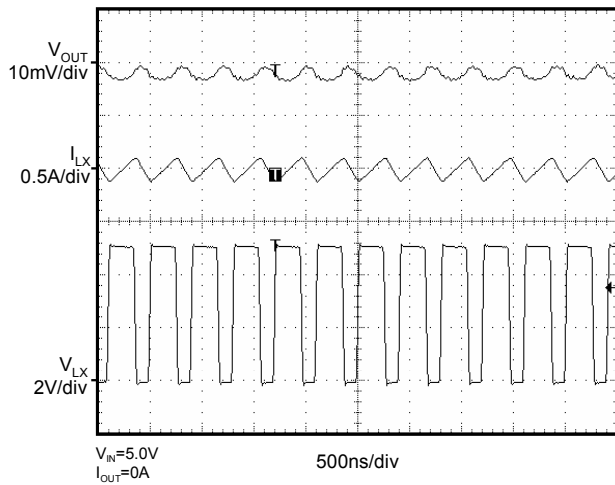

Output Voltage Ripple ( $V_{OUT} = 3.3V$ )

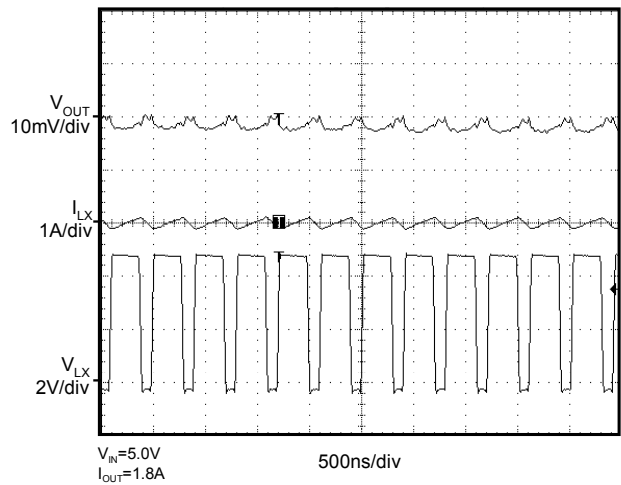

Transient Response ( $V_{OUT} = 1.5V$ ; 0A to 1A to 0A)

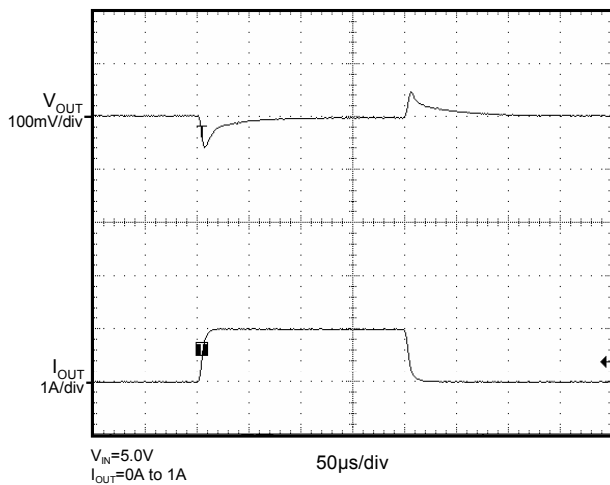

Transient Response ( $V_{OUT} = 3.3V$ ; 0A to 1A to 0A)

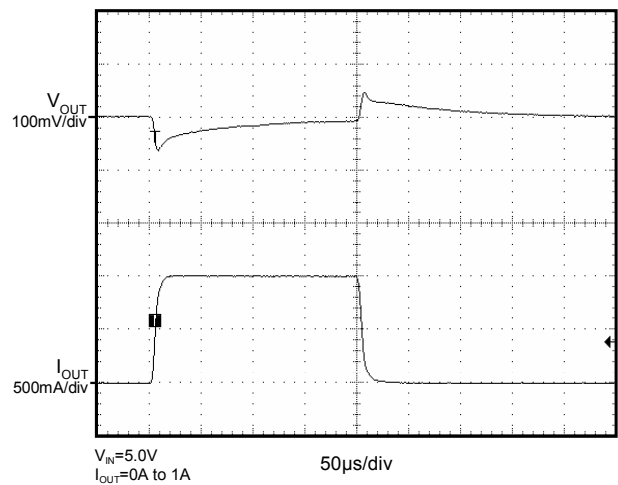

### Typical Waveforms (continued)

Circuit Conditions:  $C_{IN} = 10\mu F/6.3V$ ;  $C_{OUT} = 22\mu F/6.3V$ ,  $L = 2.2\mu H$  (TOKO: 1127AS-2R2M).

Start Up (Enable) ( $V_{OUT} = 1.5V$ )

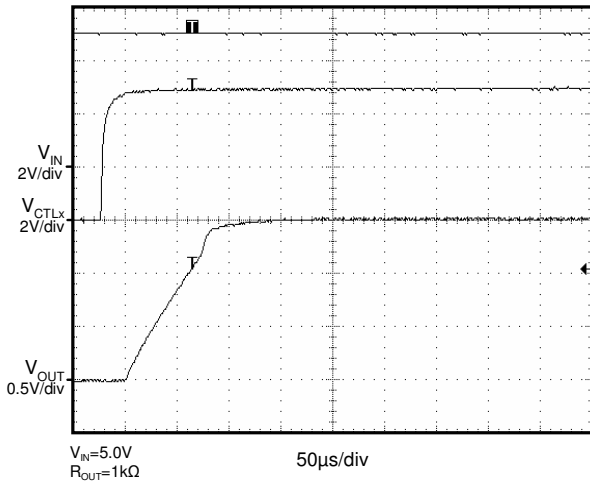

Start Up (Enable) ( $V_{OUT} = 1.5V$ )

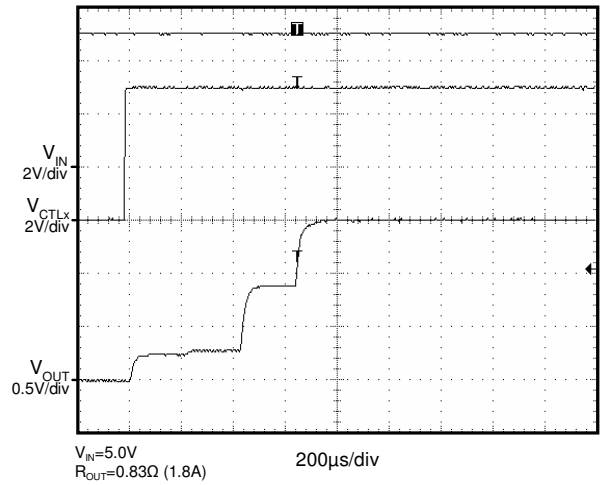

Start Up (Power up  $V_{IN} = V_{CTLX}$ ) ( $V_{OUT} = 1.5V$ )

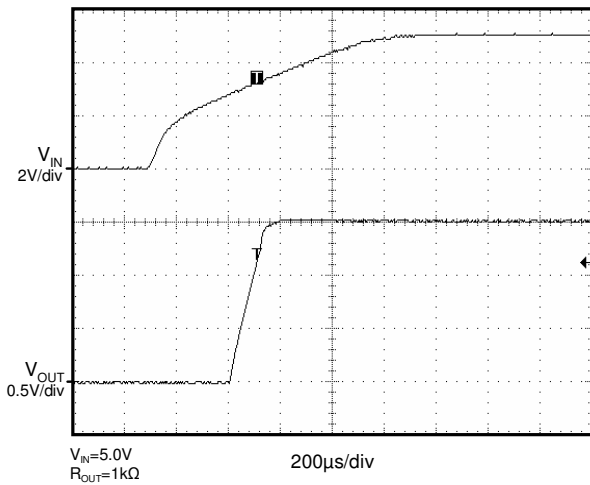

Start Up (Power up  $V_{IN} = V_{CTLX}$ ) ( $V_{OUT} = 1.5V$ )

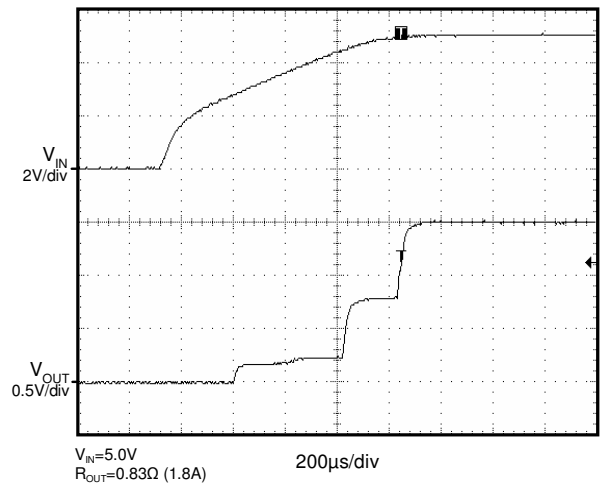

Start Up (Enable) ( $V_{OUT} = 3.3V$ )

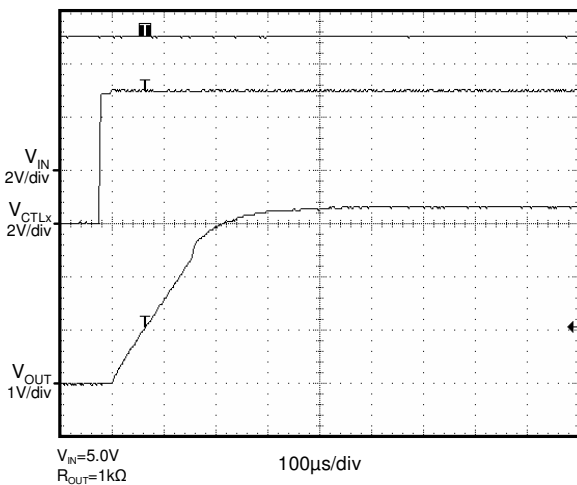

Start Up (Enable) ( $V_{OUT} = 3.3V$ )

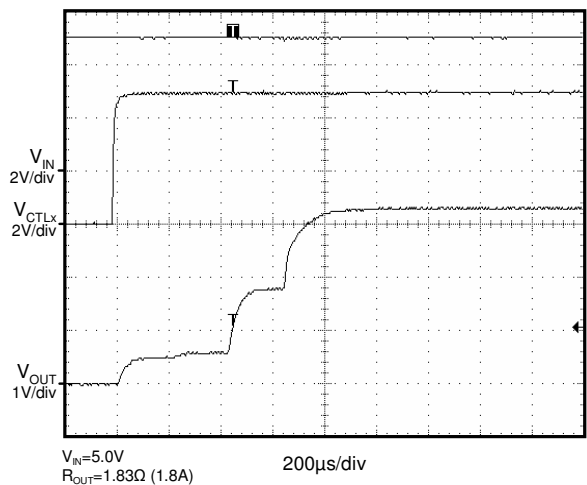



### Typical Waveforms (continued)

Circuit Conditions:  $C_{IN} = 10\mu F/6.3V$ ;  $C_{OUT} = 22\mu F/6.3V$ ,  $L = 2.2\mu H$  (TOKO: 1127AS-2R2M).

Start Up (Power up  $V_{IN} = V_{CTLX}$ ) ( $V_{OUT} = 3.3V$ )

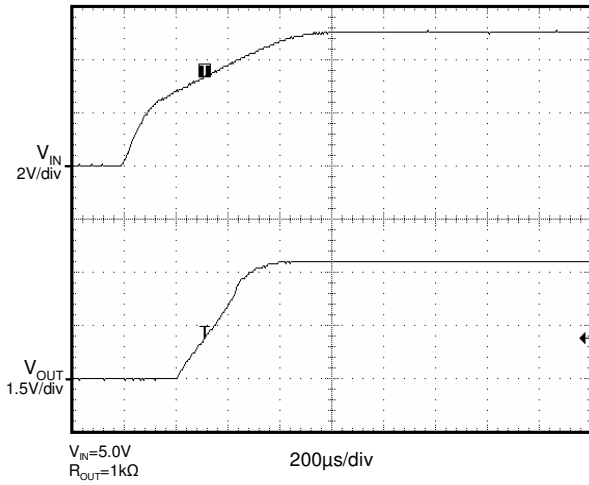

Start Up (Power up  $V_{IN} = V_{CTLX}$ ) ( $V_{OUT} = 3.3V$ )

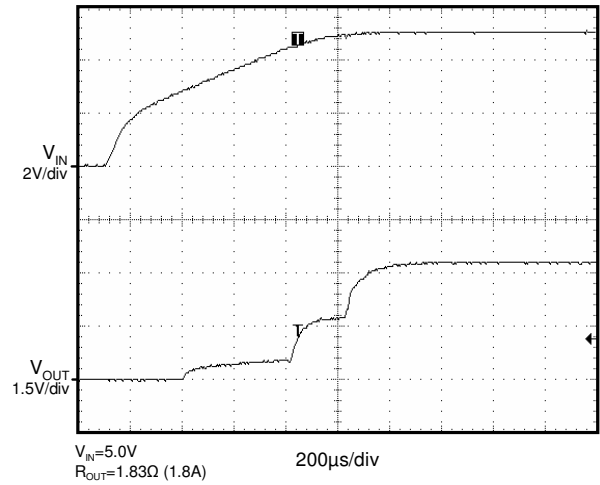

Shutdown (Disable) ( $V_{OUT} = 1.5V$ )

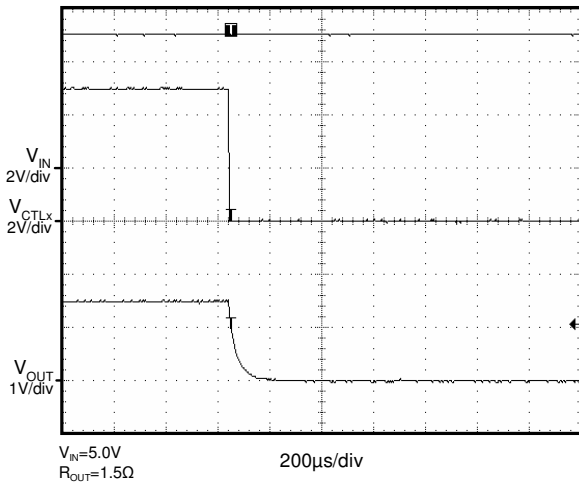

Shutdown (Disable) ( $V_{OUT} = 3.3V$ )

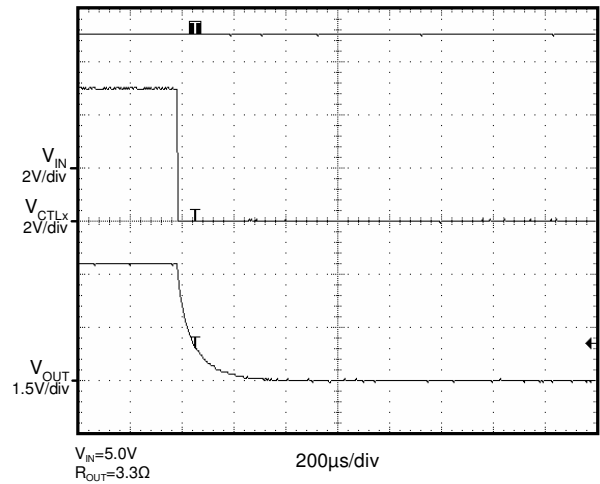

## Pin Descriptions

Pin #	Pin Name	Pin Function
1	VINA	Channel A. Input supply voltage for the converter power stage and internal circuitry.
2	LXA	Switching node of Channel A - connect an inductor between this pin and the output capacitor.
3, 13, T1	GNDA	Channel A. Ground connection for converter power stage and internal circuitry.
4, 12, T2	GNDB	Channel B. Ground connection for converter power stage and internal circuitry.
5	CTL3B	Channel B. Control bit 3 - see Table 1 for decoding. This pin has a 1 M $\Omega$ internal pulldown resistor. This resistor is switched in circuit whenever the pin voltage is below the input high threshold, or when the part is in undervoltage lockout.
6	CTL2B	Channel B. Control bit 2 - see Table 1 for decoding. This pin has a 1 M $\Omega$ internal pulldown resistor. This resistor is switched in circuit whenever the pin voltage is below the input high threshold, or when the part is in undervoltage lockout.
7	CTL1B	Channel B. Control bit 1 - see Table 1 for decoding. This pin has a 1 M $\Omega$ internal pulldown resistor. This resistor is switched in circuit whenever the pin voltage is below the input high threshold, or when the part is in undervoltage lockout.
8	CTL0B	Channel B. Control bit 0 - see Table 1 for decoding. This pin has a 1 M $\Omega$ internal pulldown resistor. This resistor is switched in circuit whenever the pin voltage is below the input high threshold, or when the part is in undervoltage lockout.
9	VOUTB	Output voltage sense pin of Channel B.
10	VINB	Channel B. Input supply voltage for the converter power stage and internal circuitry.
11	LXB	Switching node of Channel B - connect an inductor between this pin and the output capacitor.
14	CTL3A	Channel A. Control bit 3 - see Table 1 for decoding. This pin has a 1 M $\Omega$ internal pulldown resistor. This resistor is switched in circuit whenever the pin voltage is below the input high threshold, or when the part is in undervoltage lockout.
15	CTL2A	Channel A. Control bit 2 - see Table 1 for decoding. This pin has a 1 M $\Omega$ internal pulldown resistor. This resistor is switched in circuit whenever the pin voltage is below the input high threshold, or when the part is in undervoltage lockout.
16	CTL1A	Channel A. Control bit 1 - see Table 1 for decoding. This pin has a 1 M $\Omega$ internal pulldown resistor. This resistor is switched in circuit whenever the pin voltage is below the input high threshold, or when the part is in undervoltage lockout.
17	CTL0A	Channel A. Control bit 0 - see Table 1 for decoding. This pin has a 1 M $\Omega$ internal pulldown resistor. This resistor is switched in circuit whenever the pin voltage is below the input high threshold, or when the part is in undervoltage lockout.
18	VOUTA	Output voltage sense pin of Channel A.

Block Diagram

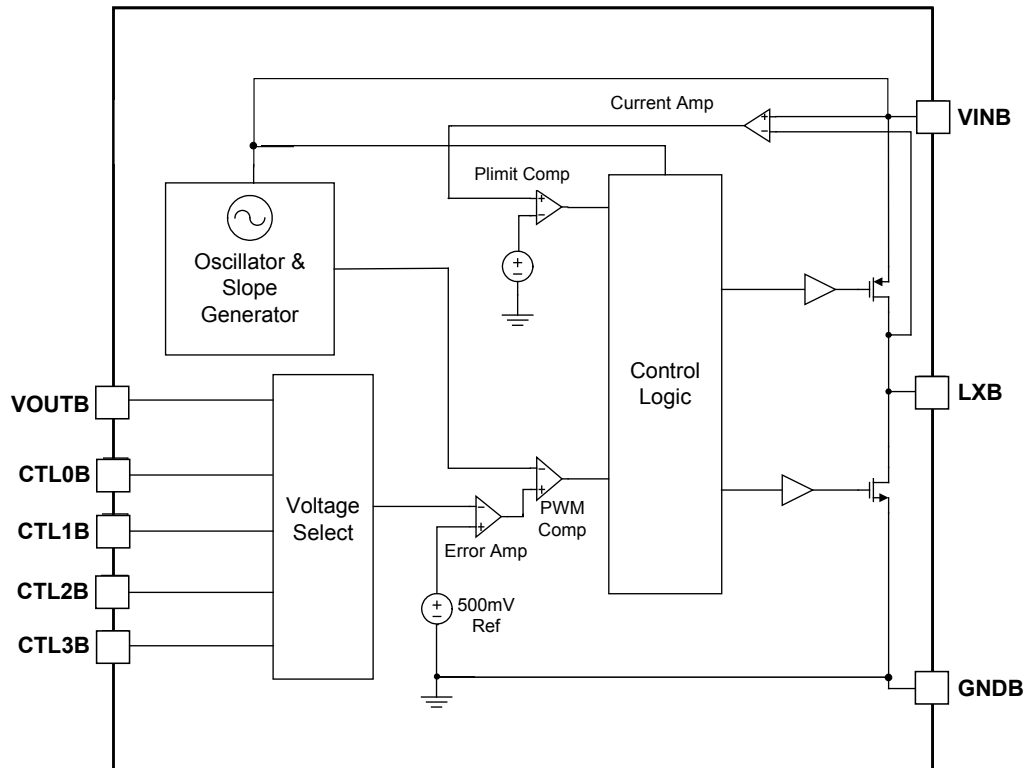
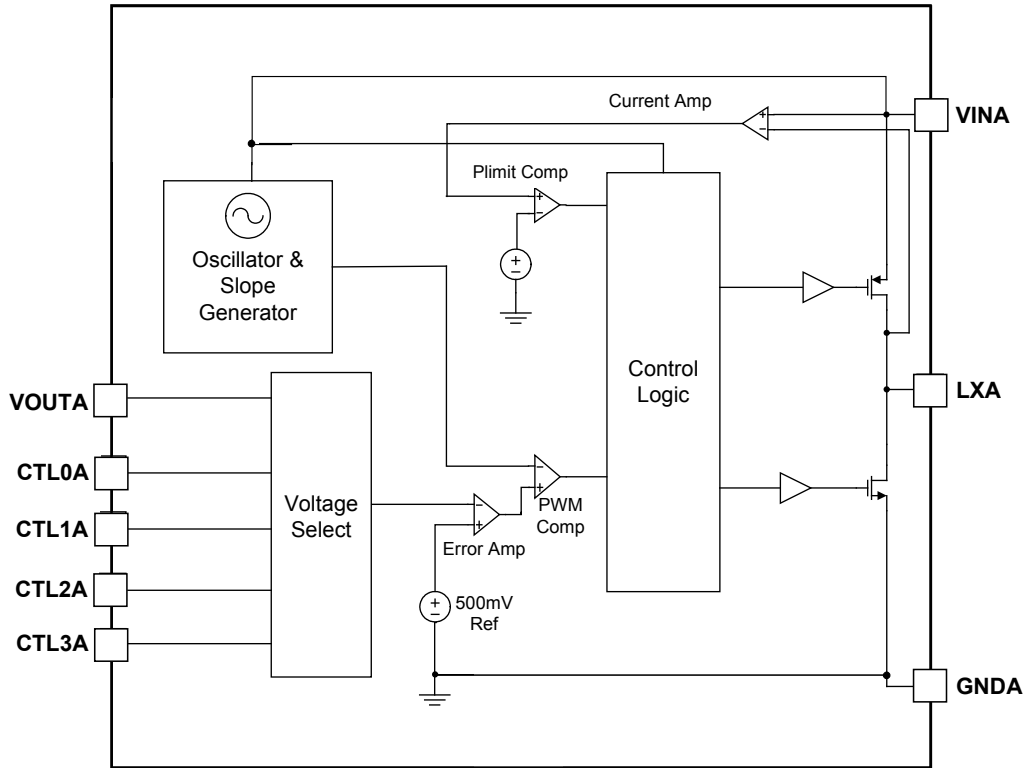

## Applications Information

### Detailed Description

The SC283 is a two channel synchronous step-down converter. Both channels on this device are designed to operate in fixed-frequency PWM mode at 2.5MHz and provide the same current capacity of up to 1.8A. The switching frequency is chosen to minimize the size of the external inductor and capacitors while maintaining high efficiency. Both channels of SC283 are independent.

### Operation

During normal operation, the PMOS MOSFET is activated on each rising edge of the internal oscillator. The voltage feedback loop uses an internal feedback resistor divider. The period is set by the internal oscillator. The device has an internal synchronous NMOS rectifier and does not require a Schottky diode on the LX pin. The device operates as a buck converter in PWM mode with a fixed frequency of 2.5MHz.

### Programmable Output Voltage

Both channels on SC283 have fifteen pre-determined output voltage values which can be individually selected by programming the CTL input pins (see Table 1 — Output Voltage Settings). Each CTL pin has an active 1 MΩ internal pulldown resistor. The 1MΩ resistor is switched in circuit whenever the CTL input voltage is below the input threshold, or when the part is in undervoltage lockout. It is recommended to tie all high CTL pins together and use an external pull-up resistor to VIN if there is no enable signal, or if the enable input is an open drain/collector signal. The CTL pins may be driven by a microprocessor to allow dynamic voltage adjustment for systems that reduce the supply voltage when entering sleep states. Avoid all zeros being present on the CTL pins when changing programmable output voltages as this would disable the device.

SC283 is also capable of regulating a different (higher) output voltage, which is not shown in the Table 1, via an external resistor divider. There will be a typical 2μA current flowing into the VOUT pin. The typical schematic for an adjustable output voltage option from the standard 1.0V with CTLx=[0010], is shown in Figure 1. RFB1 and RFB2 are used to adjust the desired output voltage. If the RFB2 current is such that the 2μA VOUT pin current can be ignored, then RFB1 can be found by Equation 1. RFB2 needs to be low

enough in value for the current through the resistor chain to be at least 20μA in order to ignore the VOUT pin current.

$$R_{FB1} = \frac{V_{OUT} - V_{OSTD}}{V_{OSTD}} \cdot R_{FB2} \quad (1)$$

where  $V_{OSTD}$  is the pre-determined output voltage via the CTL pins.

$C_{FF}$  is needed to maintain good transient response performance. The correct value of  $C_{FF}$  can be found using Equation 2.

$$C_{FF} [nF] = 2.5 \times \frac{(V_{OUT} - 0.5)^2}{R_{FB1} [k\Omega] \cdot (V_{OUT} - V_{OSTD})} \times \left( \frac{V_{OSTD}}{V_{OSTD} - 0.5} \right) \quad (2)$$

To simplify the design, it is recommended to program the desired output voltage from a standard 1.0V as shown in Figure 1 with the correct  $C_{FF}$  calculated from Equation 2. For programming the output voltage from other standard voltages,  $R_{FB1}$ ,  $R_{FB2}$  and  $C_{FF}$  need to be adjusted to meet Equations 1 and 2.

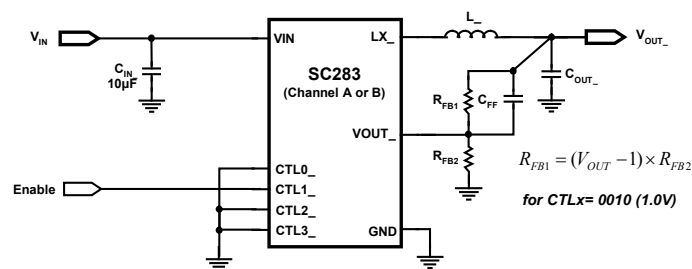

Figure 1 — Typical Schematic for Adjusting the Output Voltage Up from an Output Voltage of 1.0V (CTLx=[0010])

### Maximum Power Dissipation

Each channel of SC283 has its own  $\Theta_{JA}$  of 65°C/W when only one channel is in operation. Since both channels are within same package, there is about 50% heat which will be transferred to the adjacent channel. The equivalent total thermal impedance will be higher when the neighboring channel is also in operation. To guarantee an operating junction temperature of less than 125°C, Figure 2 shows the maximum allowable power loss of each channel. The curve is based upon the junction temperature of either channel reaching a maximum of 125°C. Each channel of SC283 can support up to 1.8A load current. Figures 3a

**Applications Information (continued)**

and 3b show the maximum allowable load current based upon the limit of maximum loss for  $V_{IN}=3.3V$  and  $V_{IN}=5.0V$ , respectively. The curves are drawn for high duty-cycle operation. If the operating duty-cycle is lower, the loss is lower allowing higher load current.

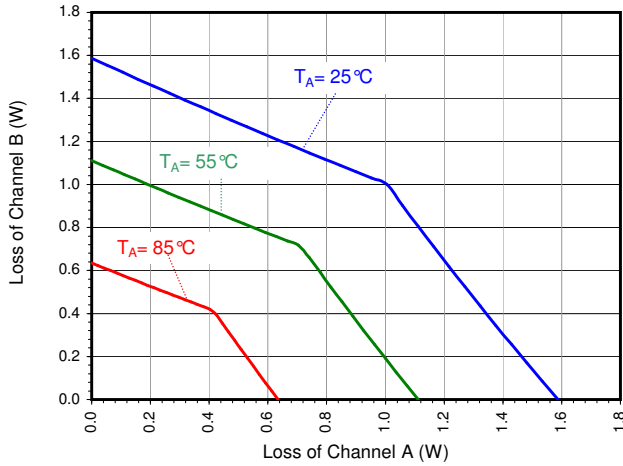

**Figure 2 — Maximum allowable loss for each channel for a maximum junction temperature of 125°C**

**Protection Features**

The SC283 provides the following protection features:

- Current Limit
- Over-Voltage Protection
- Soft-Start Operation
- Thermal Shutdown

**Current Limit and Protection**

The internal PMOS power device in the switching stage is protected by a current limit feature. If the inductor current is above the PMOS current limit for 16 consecutive cycles, the part enters foldback current limit mode and the output current is limited to the current limit holding current ( $I_{CL\_HOLD}$ ) of a few hundred milliamperes. Under this condition, the output voltage will be the product of  $I_{CL\_HOLD}$  and the load resistance. The current limit holding current will decrease when the output voltage increases. The load presented must fall below the current limit holding current for the part to exit foldback current limit mode. Figure 4 shows how the typical current limit holding current varies with output voltage. The SC283 is capable of sustaining an indefinite short circuit without damage and will resume normal operation when the fault is removed. The foldback current limit mode is disabled during soft-start. Current limit functionality is shown in Figure 6.

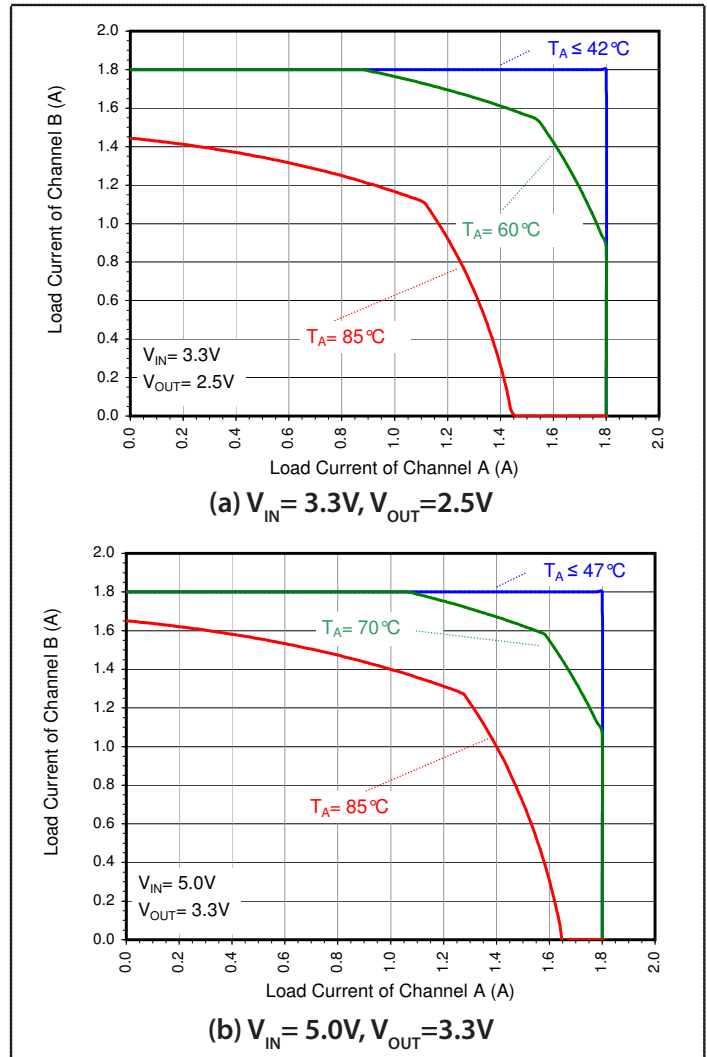

**Figure 3 — Maximum allowable Load Current for each channel for a maximum junction temperature of 125°C**

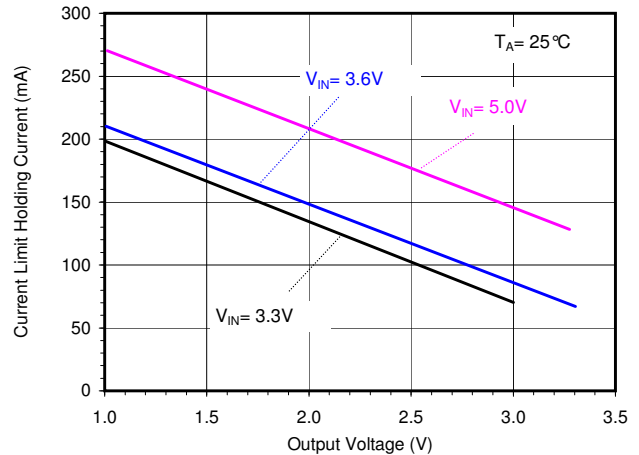

**Figure 4 — Typical Current Limit Holding Current**

## Applications Information (continued)

### vs. Output Voltage

#### Over-Voltage Protection

In the event of a 15% over-voltage on the output, the PWM drive is disabled leaving the LX pin floating.

#### Soft-Start

The soft-start mode is activated after VIN reaches its UVLO and one or more CTL pins are set high to enable the part. A thermal shutdown event will also activate the soft start sequence. Soft-start mode controls the maximum current during startup thus limiting inrush current. The PMOS current limit is stepped through four soft start levels of approximately 20%, 25%, 40%, & 100%. Each step is maintained for 200μs following an internal reference start up duration of 50μs giving a total nominal startup period of 850μs. During startup, the chip operates by controlling the inductor current swings between 0A and current limit. If at any time  $V_{OUT}$  reaches 86% of the target or at the end of the soft-start period, the SC283 will switch to PWM mode operation. Figure 5 shows the typical diagram of soft start operation.

The SC283 is capable of starting up into a pre-biased output. When the output is precharged by another supply rail, the SC283 will not discharge the output during the soft start interval.

#### Shut Down

When all CTL pins of each channel are low, the channel will run in shutdown mode, drawing less than 1μA from the input power supply. The internal switches and bandgap voltage will be immediately turned off.

#### Thermal Shutdown

The device has a thermal shutdown feature to protect the SC283 if the junction temperature exceeds 160°C. During thermal shutdown, the on-chip power devices are disabled, tri-stating the LX output. When the temperature drops by 10°C, it will initiate a soft start cycle to resume normal operation.

#### Inductor Selection

The SC283 converter has internal loop compensation. The compensation is designed to work with an output filter corner frequency of less than 40kHz for a  $V_{IN}$  of 5V and 50kHz for a  $V_{IN}$  of 3.3V over any operating condition. The

corner frequency of the output filter is shown in Equation 3.

$$f_c = \frac{1}{2\pi\sqrt{L \cdot C_{OUT}}} \quad (3)$$

Values outside this range may lead to instability, malfunction, or out-of-specification performance.

In general, the inductance is chosen by making the inductor ripple current to be less than 30% of maximum load current. When choosing an inductor, it is important to consider the change in inductance with DC bias current. The inductor saturation current is specified as the current at which the inductance drops a specific percentage from the nominal value. This is approximately 30%. Except for short-circuit or other fault conditions, the peak current must always be less than the saturation current specified by the manufacturer. The peak current is the maximum load current plus one half of the inductor ripple current at the maximum input voltage. Load and/or line transients can cause the peak current to exceed this level for short durations. Maintaining the peak current below the inductor saturation specification keeps the inductor ripple current and the output voltage ripple at acceptable levels. Manufacturers often provide graphs of actual inductance and saturation characteristics versus applied inductor current. The saturation characteristics of the inductor can vary significantly with core temperature. Core and ambient temperatures should be considered when examining the core saturation characteristics.

When the inductance has been determined, the DC resistance (DCR) must be examined. The efficiency that can be achieved is dependent on the DCR of the inductor. The lower values give higher efficiency. The RMS DC current rating of the inductor is associated with losses in the copper windings and the resulting temperature rise of the inductor. This is usually specified as the current which produces a 40°C temperature rise. Most copper windings are rated to accommodate this temperature rise above maximum ambient.

Magnetic fields associated with the output inductor can interfere with nearby circuitry. This can be minimized by the use of low noise shielded inductors which use the

### Applications Information (continued)

minimum gap possible to limit the distance that magnetic fields can radiate from the inductor. However shielded inductors typically have a higher DCR and are thus less efficient than a similarly sized non-shielded inductor.

Final inductor selection depends on various design considerations such as efficiency, EMI, size, and cost. Table 2 lists the manufacturers of recommended inductor options. The saturation characteristics and DC current ratings are also shown.

Manufacturer Part Number	L (μH)	DCR Max (Ω)	Rated Current (A)	L at Rated Current (μH)	Dimensions LxWxH (mm)
TOKO 1071AS-2R2M	2.20±20%	0.060	1.80	1.54	2.8x3.0x1.5
TOKO 1071AS-1R0N	1.00±30%	0.040	2.70	0.70	2.8x3.0x1.5
TOKO 1127AS-2R2M	2.20±20%	0.048	2.50	1.54	3.5x3.7x1.8
Panasonic ELLVGG1R0N	1.00±23%	0.062	2.20	0.70	3.2x3.2x1.5

Table 2 – Recommended Inductors

### C<sub>OUT</sub> Selection

The internal voltage loop compensation in the SC283 limits the minimum output capacitor value to 22μF if using a 2.2μH inductor or 44μF if using a 1μH inductor. This is due to its influence on the the loop crossover frequency, phase margin, and gain margin. Increasing the output capacitor above this minimum value will reduce the crossover frequency and provide greater phase margin. The total output capacitance should not exceed 50μF to avoid any start-up problems. For most typical applications it is recommended to use an output capacitance of 22μF to 44μF. When choosing the output capacitor’s capacitance, verify the voltage derating effect from the capacitor vendor’s data sheet.

Capacitors with X7R or X5R ceramic dielectric are recommended for their low ESR and superior temperature and voltage characteristics. Y5V capacitors should not be used as their temperature coefficients make them unsuitable for this application.

The output voltage droop due to a load transient is deter-

mined by the capacitance of the ceramic output capacitor. The ceramic capacitor supplies the load current initially until the loop responds. Within a few switching cycles the loop will respond and the inductor current will increase to match the required load. The output voltage droop during the period prior to the loop responding can be related to the choice of output capacitor by the relationship from Equation 4.

$$C_{OUT} = \frac{3 \cdot \Delta I_{LOAD}}{V_{DROOP} \cdot f_{OSC}} \dots\dots\dots (4)$$

The output capacitor RMS ripple current may be calculated from Equation 5.

$$I_{COUT(RMS)} = \frac{1}{2\sqrt{3}} \left( \frac{V_{OUT} \cdot (V_{IN(MAX)} - V_{OUT})}{L \cdot f_{OSC} \cdot V_{IN}} \right) \dots\dots\dots (5)$$

Table 3 lists the manufacturers of recommended output capacitor options.

Manufacturer Part Number	Value (μF)	Type	Rated Voltage (VDC)	Value at 3.3V (μF)	Dimensions LxWxH (mm)
Murata GRM21BR60J106K	10±10%	X5R	6.3	4.74	2.0x1.25x1.25 (EIA:0805)
Murata GRM219R60J106K	10±10%	X5R	6.3	4.05	2.0x1.25x0.85 (EIA:0805)
Murata GRM21BR60J226M	22±20%	X5R	6.3	6.57	2.0x1.25x1.25 (EIA:0805)
Murata GRM31CR60J476M	47±20%	X5R	6.3	20.3	3.2x1.6x1.6 (EIA:1206)

Table 3 – Recommended Capacitors

### C<sub>IN</sub> Selection

The SC283 source input current is a DC supply current with a triangular ripple imposed on it. To prevent large input voltage ripple, a low ESR ceramic capacitor is required. A minimum value of 10μF should be used. It is important to consider the DC voltage coefficient characteristics when determining the actual required value. It should be noted a 10μF, 6.3V, X5R ceramic capacitor with 5V DC applied may exhibit a capacitance as low as 4.5μF.



### Applications Information (continued)

To estimate the required input capacitor, determine the acceptable input ripple voltage and calculate the minimum value required for  $C_{IN}$  from Equation 6.

$$C_{IN} = \frac{\frac{V_{OUT}}{V_{IN}} \left( 1 - \frac{V_{OUT}}{V_{IN}} \right)}{\left( \frac{\Delta V}{I_{OUT}} - ESR \right) \cdot f_{OSC}} \quad \text{..... (6)}$$

The input capacitor RMS ripple current varies with the input and output voltage. The maximum input capacitor RMS current is found from Equation 7.

$$I_{CIN(RMS)} = \sqrt{\frac{V_{OUT}}{V_{IN}} \left( 1 - \frac{V_{OUT}}{V_{IN}} \right)} \quad \text{..... (7)}$$

The input voltage ripple and RMS current ripple are at a maximum when the input voltage is twice the output voltage or 50% duty cycle.

The input capacitor provides a low impedance loop for the edges of pulsed current drawn by the PMOS switch. Low ESR/ESL X5R ceramic capacitors are recommended for this function. To minimise stray inductance, the capacitor should be placed as closely as possible to the VIN and GND pins of the SC283.



Applications Information (continued)

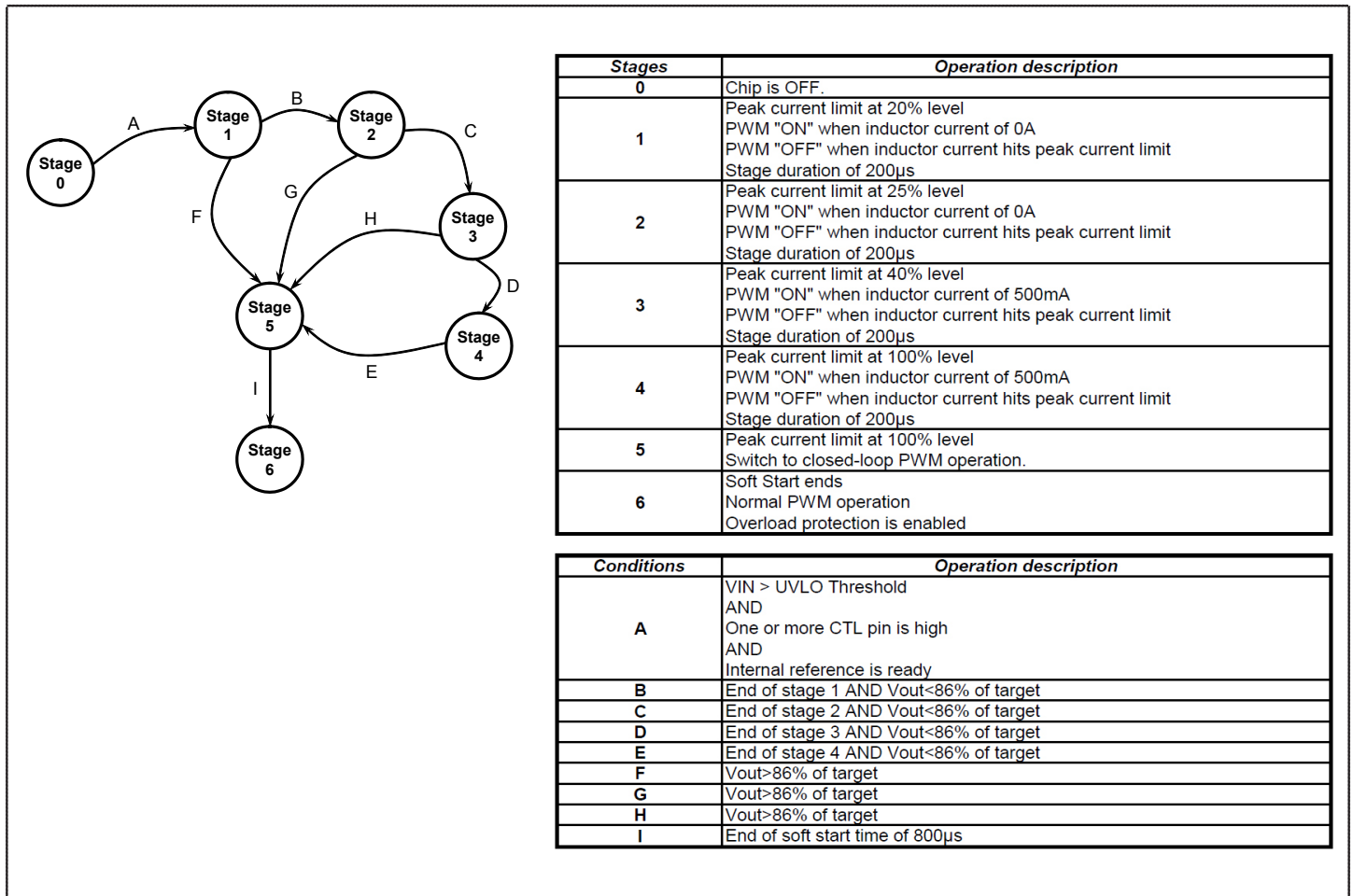

Figure 5 — Typical Diagram of Soft Start Operation

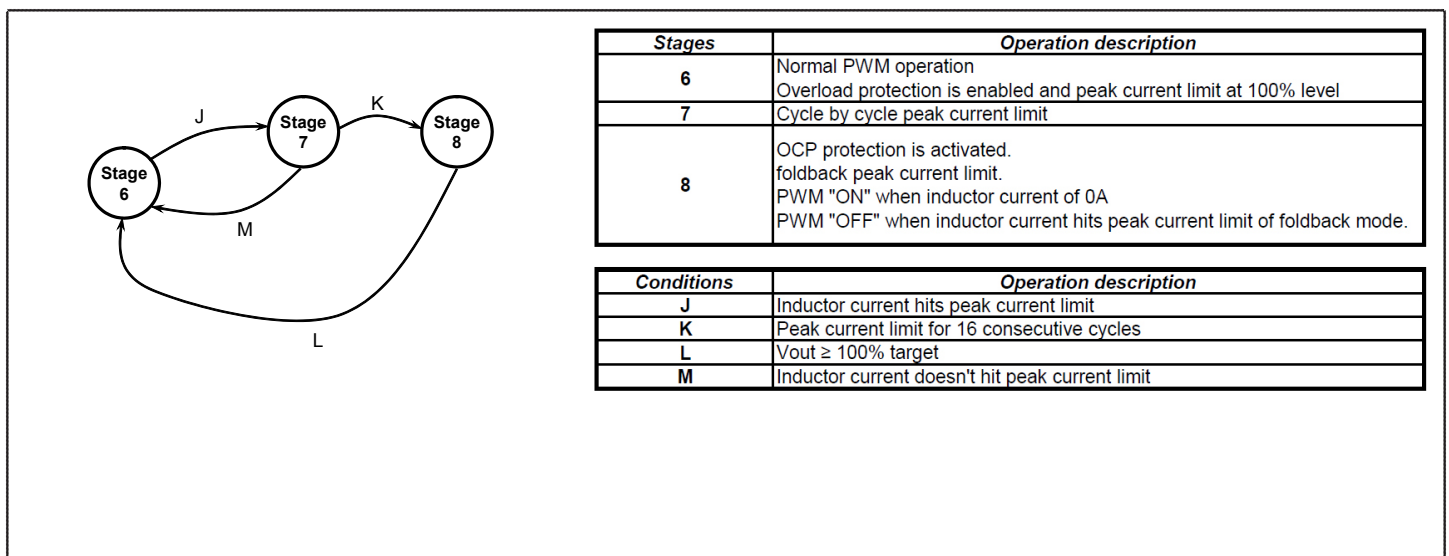

Figure 6 — Typical Diagram of Current Limit Protection

## Applications Information (continued)

### PCB Layout Considerations

The layout diagram in Figure 7 shows a recommended top-layer PCB for the SC283 and supporting components. Figure 8 shows the bottom layer for this PCB. Fundamental layout rules must be followed since the layout is critical for achieving the performance specified in the Electrical Characteristics table. Poor layout can degrade the performance of the DC-DC converter and can contribute to EMI problems, ground bounce, and resistive voltage losses. Poor regulation and instability can result.

The following guidelines are recommended when developing a PCB layout:

1. The input capacitor,  $C_{IN}$ , should be placed as close to the VIN and GND pins as possible. This capacitor provides a low impedance loop for the pulsed currents present at the buck converter's input. Use short wide traces to connect as closely to the IC as possible. This will minimize EMI and input voltage ripple by localizing the high frequency current pulses.
2. Keep the LX pin traces as short as possible to minimize pickup of high frequency switching edges to other parts of the circuit.  $C_{OUT}$  and L should be connected as close as possible between the LX and GND pins, with a direct return to the GND pin from  $C_{OUT}$ .
3. Route the output voltage feedback/sense path away from the inductor and LX node to minimize noise and magnetic interference.
4. Use a ground plane referenced to the SC283 GND pin. Use several vias to connect to the component side ground to further reduce noise and interference on sensitive circuit nodes.
5. If possible, minimize the resistance from the output and GND pin to the load. This will reduce the voltage drop on the ground plane and improve the load regulation. It will also improve the overall efficiency by reducing the copper losses on the output and ground planes.

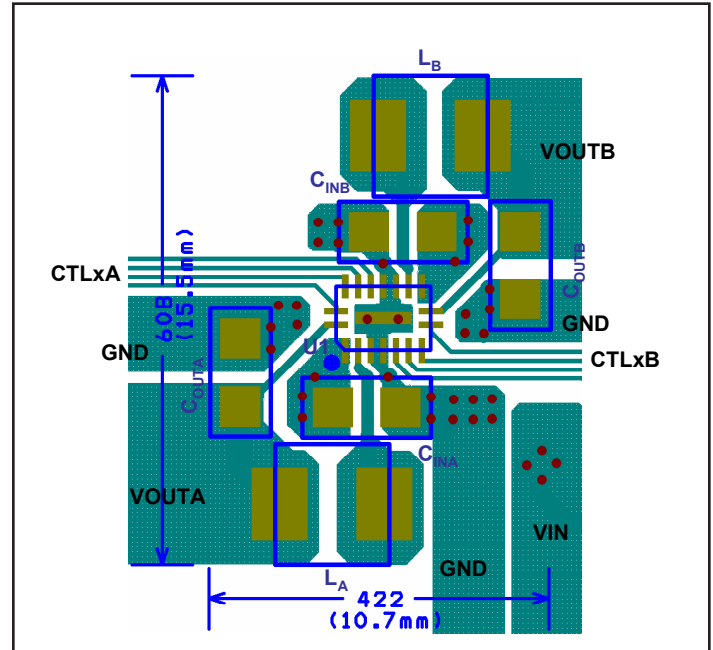

Figure 7 — Recommended PCB Layout (Top Layer)

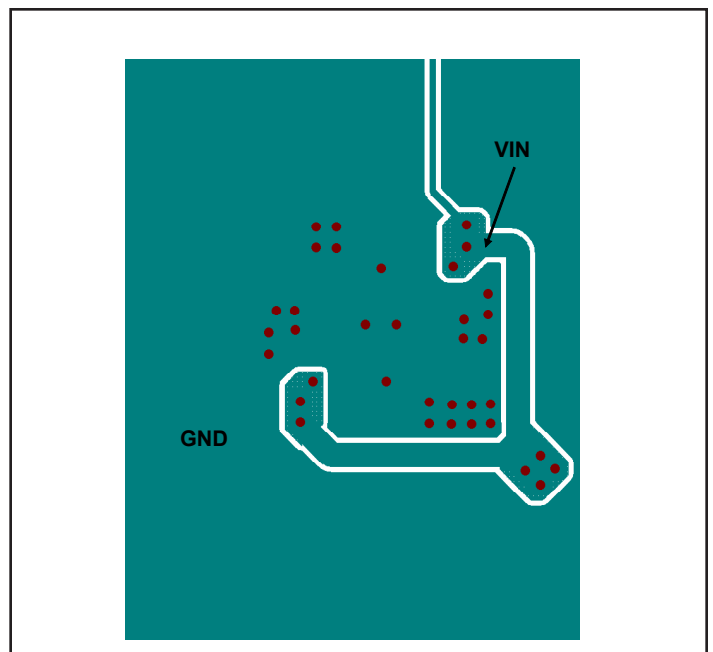
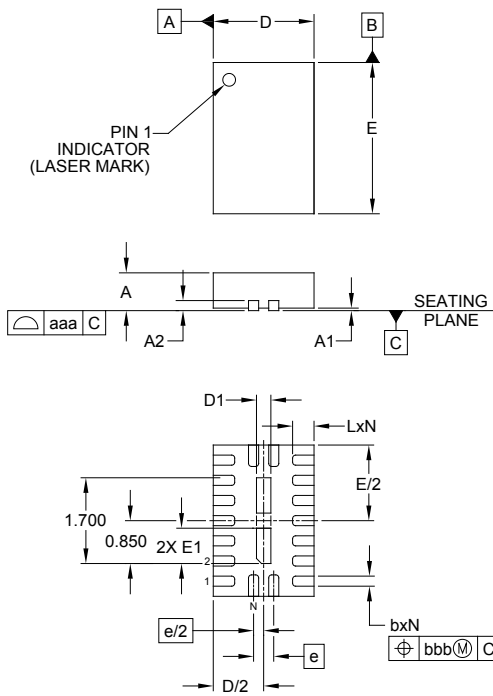

Figure 8 — Bottom Layer Detail

### Outline Drawing – 2x3 MLPQ-W18



DIM	MILLIMETERS		
	MIN	NOM	MAX
A	0.70	-	0.80
A1	0.00	-	0.05
A2	-	(0.20)	-
b	0.15	0.20	0.25
D	1.90	2.00	2.10
D1	0.136	0.286	0.386
E	2.90	3.00	3.10
E1	0.55	0.70	0.80
e	0.40 BSC		
L	0.375	0.425	0.475
N	18		
ND	2		
NE	7		
aaa	0.08		
bbb	0.10		

- NOTES:
1. CONTROLLING DIMENSIONS ARE IN MILLIMETERS (ANGLES IN DEGREES).
  2. COPLANARITY APPLIES TO THE EXPOSED PAD AS WELL AS THE TERMINALS.

### Land Pattern – 2x3 MLPQ-W18

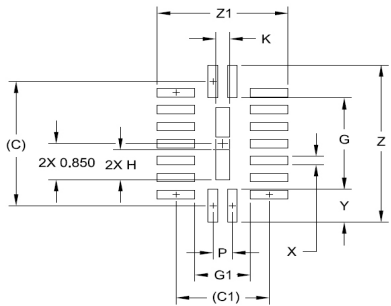

DIM	MILLIMETERS
C	(2.325)
C1	(1.925)
G	2.15
G1	1.15
H	0.70
K	0.286
P	0.40
X	0.20
Y	0.775
Z	3.70
Z1	2.70

- NOTES:
1. CONTROLLING DIMENSIONS ARE IN MILLIMETERS (ANGLES IN DEGREES).
  2. THIS LAND PATTERN IS FOR REFERENCE PURPOSES ONLY. CONSULT YOUR MANUFACTURING GROUP TO ENSURE YOUR COMPANY'S MANUFACTURING GUIDELINES ARE MET.
  3. THERMAL VIAS IN THE LAND PATTERN OF THE EXPOSED PAD SHALL BE CONNECTED TO A SYSTEM GROUND PLANE, FAILURE TO DO SO MAY COMPROMISE THE THERMAL AND/OR FUNCTIONAL PERFORMANCE OF THE DEVICE.

© Semtech 2010

All rights reserved. Reproduction in whole or in part is prohibited without the prior written consent of the copyright owner. The information presented in this document does not form part of any quotation or contract, is believed to be accurate and reliable and may be changed without notice. No liability will be accepted by the publisher for any consequence of its use. Publication thereof does not convey nor imply any license under patent or other industrial or intellectual property rights. Semtech assumes no responsibility or liability whatsoever for any failure or unexpected operation resulting from misuse, neglect improper installation, repair or improper handling or unusual physical or electrical stress including, but not limited to, exposure to parameters beyond the specified maximum ratings or operation outside the specified range.

SEMTECH PRODUCTS ARE NOT DESIGNED, INTENDED, AUTHORIZED OR WARRANTED TO BE SUITABLE FOR USE IN LIFE-SUPPORT APPLICATIONS, DEVICES OR SYSTEMS OR OTHER CRITICAL APPLICATIONS. INCLUSION OF SEMTECH PRODUCTS IN SUCH APPLICATIONS IS UNDERSTOOD TO BE UNDERTAKEN SOLELY AT THE CUSTOMER'S OWN RISK. Should a customer purchase or use Semtech products for any such unauthorized application, the customer shall indemnify and hold Semtech and its officers, employees, subsidiaries, affiliates, and distributors harmless against all claims, costs damages and attorney fees which could arise.

## Contact Information

---

Semtech Corporation  
Power Management Products Division  
200 Flynn Road, Camarillo, CA 93012  
Phone: (805) 498-2111 Fax: (805) 498-3804

[www.semtech.com](http://www.semtech.com)