

PLEASE CHECK WWW.MOLEX.COM FOR LATEST PART INFORMATION

Part Number: [0009017095](#)
Status: **Active**
Overview: [edge card connectors](#)
Description: 3.96mm (.156") Pitch KK® Crimp Housing, Edge Card Connector, Single-Sided, Surface Mount, Polarized, With Flange, 9 Circuits, Rib between 2 & 3

Documents:

[3D Model](#) [Drawing \(PDF\)](#)
[Packaging Specification \(PDF\)](#) [RoHS Certificate of Compliance \(PDF\)](#)

Agency Certification

UL E29179

General

Product Family Edge Card Connectors
 Series [2574](#)
 Component Type Edgecard to Wire
 Overview [edge card connectors](#)
 Product Name Edge Card, KK®

Physical

Circuits (Loaded) 9
 Circuits (maximum) 9
 Circuits Detail All Signal
 Color - Resin Natural
 Durability (mating cycles max) 25
 Entry Angle Vertical (Top Entry)
 Flammability 94V-2
 Keying to Mating Part Yes
 Material - Plating Mating n/a
 Material - Resin Nylon
 PCB Retention None
 PCB Thickness Recommended (in) 0.062 In
 PCB Thickness Recommended (mm) 1.60 mm
 Packaging Type Bag
 Panel Mount With Flange
 Pitch - Mating Interface (in) 0.156 In
 Pitch - Mating Interface (mm) 3.96 mm
 Polarized to Mating Part Yes
 Temperature Range - Operating 0°C to +75°C
 Termination Interface: Style N/A

Electrical

Current - Maximum per Contact 4.25A, 4.5A, 4.75A, 4A, 5A
 Voltage - Maximum 250V

Material Info

Old Part Number 2574-09B2

Reference - Drawing Numbers

Packaging Specification PK-2574-001
 Sales Drawing SD-2574

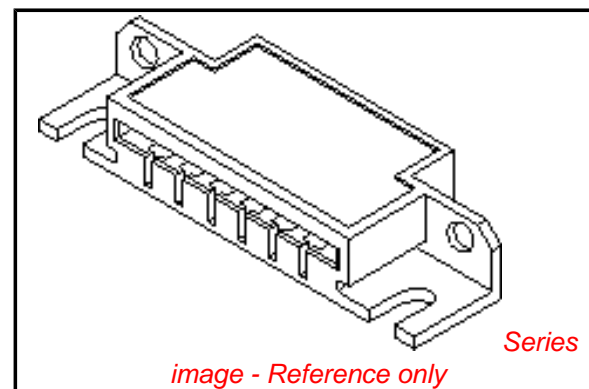

EU RoHS

**ELV and RoHS
 Compliant**
**REACH SVHC
 Contains SVHC: No**
**Halogen-Free
 Status**

China RoHS



Not Reviewed

Need more information on product environmental compliance?

Email productcompliance@molex.com
 For a multiple part number RoHS Certificate of Compliance, [click here](#)

Please visit the [Contact Us](#) section for any non-product compliance questions.

Search Parts in this Series

[2574Series](#)

Mates With

PCB, 1.6mm (0.62") max. thickness

Use With

[2878](#) Terminals, [2478](#) Terminals, [2578](#) Terminals, Bifurcated

NOTES:

1. MATERIAL: NYLON 6/6, 94V-2.
2. FINISH: SEE CRIMP TERMINAL DRAWING.
3. THIS PRODUCT CONFORMS TO PRODUCT SPECIFICATION PS-08-50.
4. PACKAGING: BULK PER PK-2574-001
5. CONNECTOR TO BE USED WITH CRIMP TERMINALS:
 2478-* 18-24 GAGE WIRE; .110/(2.79) MAX. INSULATION DIAMETER.
 2578-* 22-26 GAGE WIRE; .065/(1.65) MAX. INSULATION DIAMETER.
6. DIMENSIONS GIVEN ACROSS CENTERLINES ARE SYMMETRICAL ABOUT THOSE CENTERLINES WITHIN ONE HALF THE TOTAL TOLERANCE.
7. PARTS LESS THAN 7 CIRCUITS ARE TO INDICATE ONLY CIRCUIT NO. 1. ALL OTHERS ARE TO IDENTIFY BOTH THE FIRST AND LAST CIRCUITS.
8. PART CONFORMS TO CLASS B REQUIREMENTS OF COSMETIC SPECIFICATION PS-45499-002

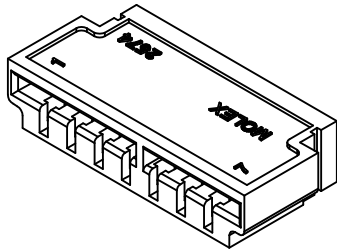
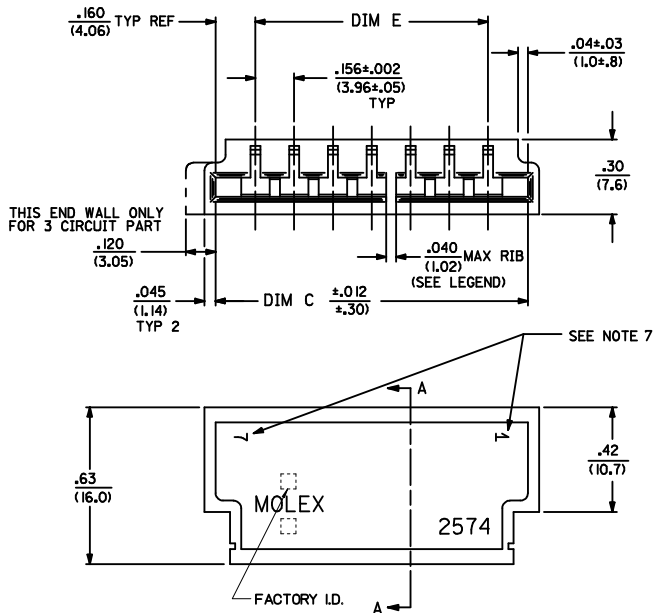

SECTION A-A

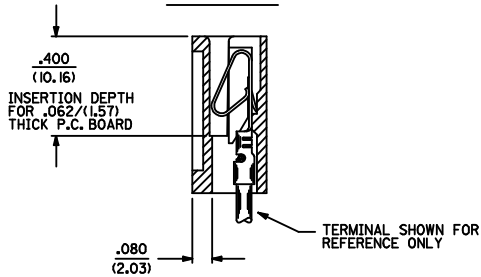

2574 - N * * *

NO. OF CIRCUITS
 COLOR CODE
 BLANK=NATURAL
 BK=BLACK

OPTION CODE

CODE	MOUNTING EARS	CHAMFERED SLOT	PCB THK	MOUNTING HOLES
A	NO	NO	.062	NO
B	YES	NO	.062	NO
C	NO	YES	.062	NO
D	YES	YES	.062	NO
E	NO	NO	.032	NO
F	YES	NO	.062	YES

RIB LOCATION CODE (BETWEEN CKTS)

- 1 = NONE
- 2 = 2-3
- 3 = 3-4
- 4 = 5-6
- 5 = 3-4, 5-6
- 6 = 4-5, 7-8
- 7 = 5-6, 8-9
- 8 = 5-6, 10-11
- 9 = 4-5, 7-8, 11-12
- 10 = 5-6, 10-11, 14-15
- 11 = 5-6, 10-11, 15-16
- 12 = 5-6, 11-12, 16-17
- 13 = 5-6, 11-12, 17-18
- 14 = 4-5, 7-8, 11-12, 15-16
- 15 = 4-5, 8-9, 12-13, 16-17, 20-21
- 16 = 5-6, 11-12, 18-19

3	C10
2	C10
1	C10
SN	REV.

ADD PART NUMBERS DEC NO: UCP2009-0858 DRAWN/KIPER 2008/12/29 CHKD/SOUSEK 2008/12/30 APPR/FSMTH 2009/01/05	QUALITY SYMBOLS =0 =0	GENERAL TOLERANCES (UNLESS SPECIFIED)		DIMENSION STYLE IN/MM		SCALE 4:1	DESIGN UNITS INCH	THIRD ANGLE PROJECTION
		4 PLACES ± --- ± --- 3 PLACES ± --- ± .010 2 PLACES ± 0.25 ± .015 1 PLACE ± 0.36 ± ---	DRAWN BY PEREZ-ARGUET 1988/03/02	DATE 1988/03/02	TITLE EDGE CARD CONNECTOR .156/(3.96) CENTERS CRIMP TYPE-2574 SERIES			
		ANGULAR ±1/2°	CHECKED BY PATEL 1988/03/02	DATE 1988/03/02	MOLEX INCORPORATED			
		DRAFT WHERE APPLICABLE MUST REMAIN WITHIN DIMENSIONS	APPROVED BY LENZ 1988/03/02	DATE 1988/03/02	MATERIAL NO. SEE CHART	DOCUMENT NO. SD-2574	SHEET NO. 1 OF 3	



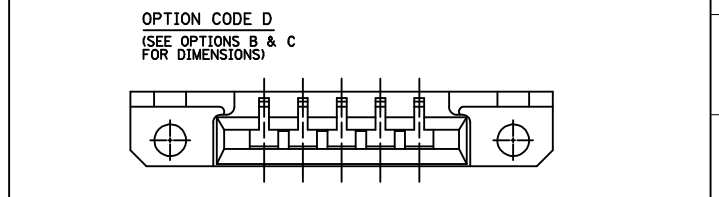
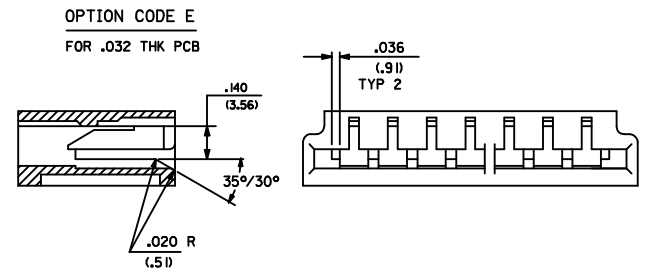
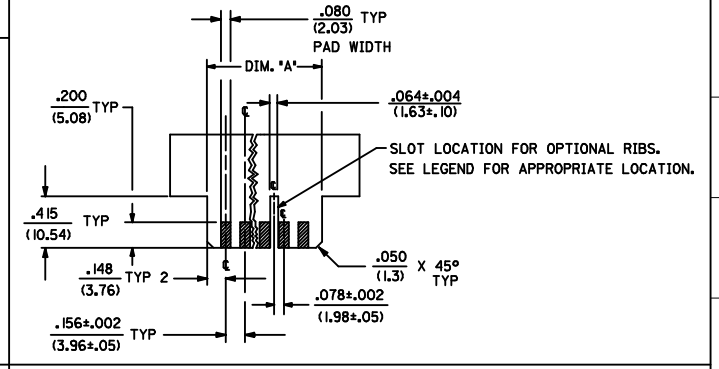
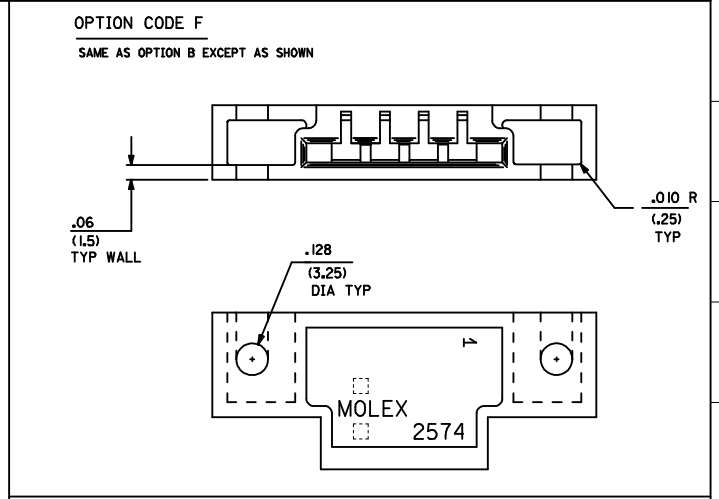
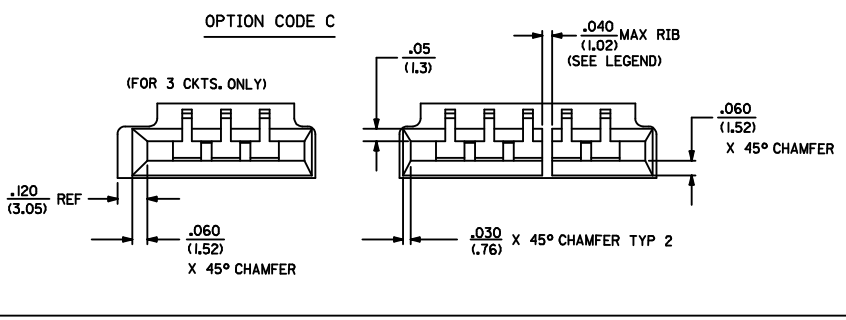
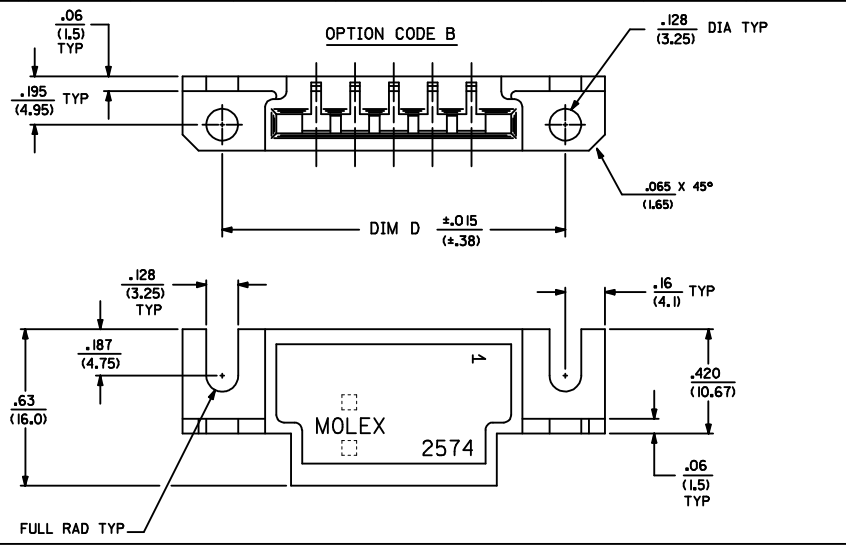

THIS DRAWING CONTAINS INFORMATION THAT IS PROPRIETARY TO MOLEX INCORPORATED AND SHOULD NOT BE USED WITHOUT WRITTEN PERMISSION

NO. OF CKT'S	DIM. C	DIM. D	DIM. E	DIM. A
3	.632 (16.05)	1.143 (29.03)	.312±.002 (7.92±.05)	.618 (15.70)
4	.788 (20.02)	1.224 (31.09)	.468±.002 (11.89±.05)	.774 (19.66)
5	.944 (23.98)	1.380 (35.05)	.624±.003 (15.85±.08)	.922 (23.42)
6	1.100 (27.94)	1.536 (39.01)	.780±.003 (19.81±.08)	1.078 (27.38)
7	1.256 (31.90)	1.692 (42.98)	.936±.003 (23.77±.08)	1.232 (31.29)
8	1.412 (35.86)	1.848 (46.94)	1.092±.004 (27.74±.10)	1.388 (35.26)
9	1.568 (39.83)	2.004 (50.90)	1.248±.004 (31.70±.10)	1.544 (39.22)
10	1.724 (43.79)	2.160 (54.86)	1.404±.006 (35.66±.15)	1.700 (43.18)
11	1.880 (47.75)	2.316 (58.83)	1.560±.006 (39.62±.15)	1.854 (47.09)
12	2.036 (51.71)	2.472 (62.79)	1.716±.006 (43.59±.15)	2.010 (51.05)
13	2.192 (55.68)	2.628 (66.75)	1.872±.006 (47.55±.15)	2.164 (54.97)
14	2.348 (59.64)	2.784 (70.71)	2.028±.007 (51.51±.18)	2.318 (58.88)
15	2.504 (63.60)	2.940 (74.68)	2.184±.007 (55.47±.18)	2.474 (62.84)
16	2.660 (67.56)	3.096 (78.64)	2.340±.007 (59.44±.18)	2.631 (66.83)
17	2.816 (71.53)	3.252 (82.60)	2.496±.008 (63.40±.20)	2.784 (70.71)
18	2.972 (75.49)	3.408 (86.56)	2.652±.009 (67.36±.23)	2.954 (75.03)
19	3.128 (79.45)	3.564 (90.53)	2.808±.009 (71.32±.23)	3.095 (78.61)
20	3.284 (83.41)	3.720 (94.49)	2.964±.009 (75.29±.23)	3.251 (82.58)
21	3.440 (87.38)	3.876 (98.45)	3.120±.010 (79.25±.25)	3.407 (86.54)
22	3.596 (91.34)	4.032 (102.41)	3.276±.011 (83.21±.25)	3.562 (90.47)
23	3.752 (95.30)	4.188 (106.38)	3.432±.011 (87.17±.28)	3.716 (94.39)
24	3.908 (99.26)	4.344 (110.34)	3.588±.012 (91.14±.30)	3.871 (98.32)



REVISE FACTORY ID: DEC NO. UCF2009-0858 DRAWN BY: DRWNK/PPER CHKD:SSOUSEK APPR:FSM/TH 2008/12/29 2008/12/30 2009/01/05	QUALITY SYMBOLS ▽=0 ▽=0	GENERAL TOLERANCES (UNLESS SPECIFIED)		DIMENSION STYLE IN/MM		SCALE ---		DESIGN UNITS INCH		THIRD ANGLE PROJECTION	
		4 PLACES ± --- ± --- 3 PLACES ± --- ± .005 2 PLACES ± 0.13 ± .01 1 PLACE ± 0.25 ± ---		mm INCH		DRAWN BY: PEREZ-ARGUET DATE: 1988/03/02		CHECKED BY: DATE:		TITLE:	
DESCRIPTION C10		DRAFT WHERE APPLICABLE MUST REMAIN WITHIN DIMENSIONS		APPROVED BY: ENZ DATE: 1988/03/02		MATERIAL NO.: SEE CHART		DOCUMENT NO.: SD-2574		MOLEX INCORPORATED	
				ANGLULAR ±1/2°		SHEET NO.: 2 OF 3		THIS DRAWING CONTAINS INFORMATION THAT IS PROPRIETARY TO MOLEX INCORPORATED AND SHOULD NOT BE USED WITHOUT WRITTEN PERMISSION			

	2574-NA*		2574-NB*		2574-NC*		2574-ND*		2574-NE*		2574-NF*	
	PART NO.	ENG. NO. (SUFFIX ONLY)	PART NO.	ENG. NO. (SUFFIX ONLY)	PART NO.	ENG. NO. (SUFFIX ONLY)	PART NO.	ENG. NO. (SUFFIX ONLY)	PART NO.	ENG. NO. (SUFFIX ONLY)	PART NO.	ENG. NO. (SUFFIX ONLY)
M	09-01-6031	-3A1	09-01-7031	-3B1	09-01-6038	-3C1	09-01-6082	-3D		-4E1	09-01-7065	-6F1-BK
	09-01-6041	-4A1	09-01-7041	-4B1	009-01-6048	-04C1				-6E1	09-01-7087	-8F1-BK
	09-01-6051	-5A1	09-01-7051	-5B1	09-01-6088	-08C1						
	09-01-6064	-6A1	09-01-7064	-6B1		-20C1						
	09-01-6081	-8A1	09-01-7081	-8B1								
L		-8A1D	09-01-7069	-6B1D								
	09-01-6055	-5A2		-8B1D								
	09-01-6061	-6A2	09-01-7061	-6B2								
	09-01-6085	-8A2	09-01-7085	-8B2								
	09-01-6095	-9A2	09-01-7095	-9B2								
	09-01-6071	-7A3	09-01-7071	-7B3								
	09-01-6086	-8A3	09-01-7086	-8B3								
K	09-01-6083	-8A4	09-01-7083	-8B4								
	09-01-6094	-9A4	09-01-7094	-9B4								
	09-01-6091	-9A5	09-01-7091	-9B5								
	09-01-6101	-10A6	09-01-7101	-10B6								
	09-01-6121	-12A7	09-01-7121	-12B7								
	09-01-6129	-12A4	09-01-7129	-12B4								
J	09-01-6181	-18A8	09-01-7181	-18B8								
	09-01-6151	-15A9	09-01-7151	-15B9								
	09-01-6161	-16A9	09-01-7161	-16B9								
	09-01-6171	-17A10	09-01-7171	-17B10								
	09-01-6211	-21A11	09-01-7211	-21B11								
	09-01-6224	-22A12	09-01-7224	-22B12								
	09-01-6221	-22A13	09-01-7221	-22B13								
I	09-01-6191	-19A14	09-01-7191	-19B14								
	09-01-6241	-24A15	09-01-7241	-24B15								
	09-01-7222	-22A16		-6B1-BK								

ADD PART NUMBERS DEC. NO. UCP2009-0858 DRAWN BY PER 2008/12/29 CHKD:SSOUSEK 2008/12/30 APPR:FSM TH 2009/01/05	QUALITY SYMBOLS  = 0.005  = 0.010	GENERAL TOLERANCES (UNLESS SPECIFIED)		DIMENSION STYLE IN/MM		SCALE ---	DESIGN UNITS INCH	 THIRD ANGLE PROJECTION	
		4 PLACES # --- # --- 3 PLACES # --- # --- 2 PLACES # --- # --- 1 PLACE # --- # ---	mm INCH	DRAWN BY PEREZ-ARGUET 1988/03/02	DATE 1988/03/02	TITLE EDGE CARD CONNECTOR .156/(3.96) CENTERS CRIMP TYPE-2574 SERIES			
		ANGULAR ±1/2°		CHECKED BY PATEL 1988/03/02	DATE 1988/03/02	 MOLEX INCORPORATED			
		DRAFT WHERE APPLICABLE MUST REMAIN WITHIN DIMENSIONS		APPROVED BY ENZ 1988/03/02	DATE 1988/03/02	WATERMARK NO. SEE CHART	DOCUMENT NO. SD-2574	SHEET NO. 3 OF 3	