

SKM 300GB125D

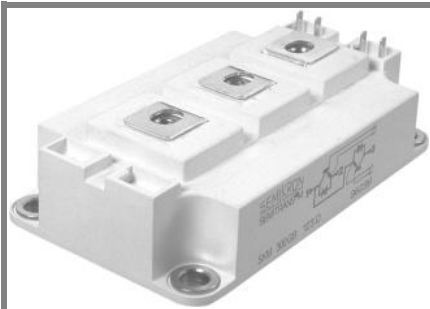

SEMITRANS® 3

Ultra Fast IGBT Module

SKM 300GB125D

Features

- NPT - Non punch-through IGBT
- Low inductance case
- Short tail current with low temperature dependence
- High short circuit capability, self limiting
- Fast & soft inverse CAL diodes
- Isolated copper baseplate using DCB Direct Copper Bonding Technology
- Large clearance (10 mm) and creepage distances (20 mm)

Typical Applications

- Switched mode power supplies at $f_{sw} > 20$ kHz
- Resonant inverters up to 100 kHz
- Inductive heating
- UPS Uninterruptable power supplies at $f_{sw} > 20$ kHz
- Electronic welders at $f_{sw} > 20$ kHz

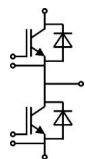

GB

Absolute Maximum Ratings		$T_c = 25^\circ\text{C}$, unless otherwise specified		
Symbol	Conditions	Values		Units
IGBT				
V_{CES}	$T_j = 25^\circ\text{C}$	1200		V
I_C	$T_j = 150^\circ\text{C}$	$T_{case} = 25^\circ\text{C}$	300	A
		$T_{case} = 80^\circ\text{C}$	210	A
I_{CRM}	$I_{CRM} = 2 \times I_{Cnom}$	400		A
V_{GES}		± 20		V
t_{psc}	$V_{CC} = 600\text{ V}; V_{GE} \leq 20\text{ V}; T_j = 125^\circ\text{C}$ $V_{CES} < 1200\text{ V}$	10		μs
Inverse Diode				
I_F	$T_j = 150^\circ\text{C}$	$T_{case} = 25^\circ\text{C}$	260	A
		$T_{case} = 80^\circ\text{C}$	180	A
I_{FRM}	$I_{FRM} = 2 \times I_{Fnom}$	400		A
I_{FSM}	$t_p = 10\text{ ms}; \text{sin.}$	$T_j = 150^\circ\text{C}$	1800	A
Module				
$I_{t(RMS)}$		500		A
T_{vj}		- 40...+ 150		$^\circ\text{C}$
T_{stg}		- 40...+ 125		$^\circ\text{C}$
V_{isol}	AC, 1 min.	4000		V

Characteristics		$T_c = 25^\circ\text{C}$, unless otherwise specified			
Symbol	Conditions	min.	typ.	max.	Units
IGBT					
$V_{GE(th)}$	$V_{GE} = V_{CE}; I_C = 8\text{ mA}$	4,5	5,5	6,5	V
I_{CES}	$V_{GE} = 0\text{ V}, V_{CE} = V_{CES}$		0,1	0,3	mA
V_{CE0}		$T_j = 25^\circ\text{C}$	1,5	1,75	V
		$T_j = 125^\circ\text{C}$	1,7		V
r_{CE}	$V_{GE} = 15\text{ V}$	$T_j = 25^\circ\text{C}$	9	10,5	m Ω
		$T_j = 125^\circ\text{C}$	11,5		m Ω
$V_{CE(sat)}$	$I_{Cnom} = 200\text{ A}, V_{GE} = 15\text{ V}$		3,3	3,85	V
C_{ies}			18	24	nF
C_{oes}	$V_{CE} = 25, V_{GE} = 0\text{ V}$		2,5	3,2	nF
C_{res}	$f = 1\text{ MHz}$		1	1,3	nF
Q_G	$V_{GE} = 0\text{ V} - +20\text{ V}$		2000		nC
R_{Gint}	$T_j = ^\circ\text{C}$		2,5		Ω
$t_{d(on)}$			130		ns
t_r	$R_{Gon} = 3\ \Omega$	$V_{CC} = 600\text{ V}$ $I_C = 200\text{ A}$	40		ns
E_{on}			16		mJ
$t_{d(off)}$	$R_{Goff} = 3\ \Omega$	$T_j = 125^\circ\text{C}$ $V_{GE} = \pm 15\text{ V}$	460		ns
t_f			30		ns
E_{off}					mJ
$R_{th(j-c)}$	per IGBT			0,075	K/W

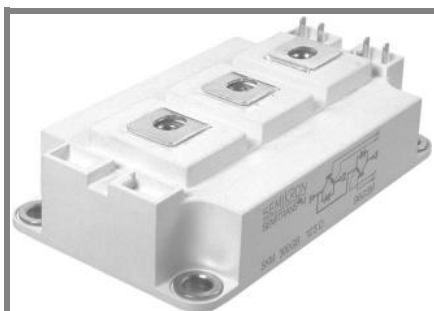

SEMITRANS® 3

Ultra Fast IGBT Module

SKM 300GB125D

Features

- NPT - Non punch-through IGBT
- Low inductance case
- Short tail current with low temperature dependence
- High short circuit capability, self limiting
- Fast & soft inverse CAL diodes
- Isolated copper baseplate using DCB Direct Copper Bonding Technology
- Large clearance (10 mm) and creepage distances (20 mm)

Typical Applications

- Switched mode power supplies at $f_{sw} > 20$ kHz
- Resonant inverters up to 100 kHz
- Inductive heating
- UPS Uninterruptable power supplies at $f_{sw} > 20$ kHz
- Electronic welders at $f_{sw} > 20$ kHz



GB

Characteristics				min.	typ.	max.	Units
Symbol	Conditions						
Inverse Diode							
$V_F = V_{EC}$	$I_{Fnom} = 200$ A; $V_{GE} = 0$ V	$T_j = 25$ °C _{chiplev.}		2		2,5	V
		$T_j = 125$ °C _{chiplev.}		1,8			V
V_{F0}		$T_j = 25$ °C		1,1		1,2	V
		$T_j = 125$ °C					V
r_F		$T_j = 25$ °C		4,5		6,5	mΩ
		$T_j = 125$ °C					mΩ
I_{RRM}	$I_F = 200$ A	$T_j = 125$ °C		340			A
Q_{rr}	$di/dt = 8000$ A/μs			46			μC
E_{rr}	$V_{GE} = 0$ V; $V_{CC} = 600$ V						mJ
$R_{th(j-c)D}$	per diode					0,18	K/W
Module							
L_{CE}				15		20	nH
$R_{CC'+EE'}$	res., terminal-chip	$T_{case} = 25$ °C		0,35			mΩ
		$T_{case} = 125$ °C		0,5			mΩ
$R_{th(c-s)}$	per module					0,038	K/W
M_s	to heat sink M6			3		5	Nm
M_t	to terminals M6			2,5		5	Nm
w						325	g

This is an electrostatic discharge sensitive device (ESDS), international standard IEC 60747-1, Chapter IX.

This technical information specifies semiconductor devices but promises no characteristics. No warranty or guarantee expressed or implied is made regarding delivery, performance or suitability.

SKM 300GB125D

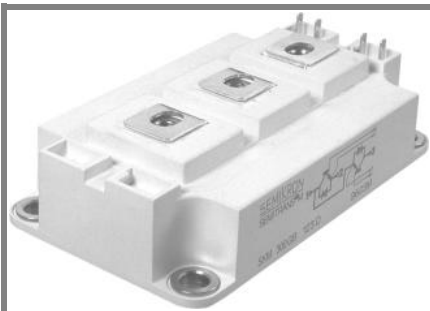

SEMITRANS® 3

Ultra Fast IGBT Module

SKM 300GB125D

Features

- NPT - Non punch-through IGBT
- Low inductance case
- Short tail current with low temperature dependence
- High short circuit capability, self limiting
- Fast & soft inverse CAL diodes
- Isolated copper baseplate using DCB Direct Copper Bonding Technology
- Large clearance (10 mm) and creepage distances (20 mm)

Typical Applications

- Switched mode power supplies at $f_{sw} > 20$ kHz
- Resonant inverters up to 100 kHz
- Inductive heating
- UPS Uninterruptable power supplies at $f_{sw} > 20$ kHz
- Electronic welders at $f_{sw} > 20$ kHz

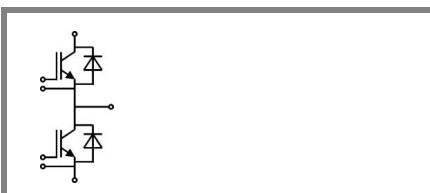

GB

Z_{th}		Values	Units
Symbol	Conditions		
$Z_{th(j-c)I}$			
$R_{\theta j-c}$	$i = 1$	53	mk/W
$R_{\theta j-c}$	$i = 2$	18,5	mk/W
$R_{\theta j-c}$	$i = 3$	3,1	mk/W
$R_{\theta j-c}$	$i = 4$	4	mk/W
$\tau_{th(j-c)}$	$i = 1$	0,04	s
$\tau_{th(j-c)}$	$i = 2$	0,0189	s
$\tau_{th(j-c)}$	$i = 3$	0,0017	s
$\tau_{th(j-c)}$	$i = 4$	0,003	s
$Z_{th(j-c)D}$			
$R_{\theta j-c}$	$i = 1$	115	mk/W
$R_{\theta j-c}$	$i = 2$	52	mk/W
$R_{\theta j-c}$	$i = 3$	11	mk/W
$R_{\theta j-c}$	$i = 4$	2	mk/W
$\tau_{th(j-c)}$	$i = 1$	0,0366	s
$\tau_{th(j-c)}$	$i = 2$	0,0113	s
$\tau_{th(j-c)}$	$i = 3$	0,003	s
$\tau_{th(j-c)}$	$i = 4$	0,0002	s

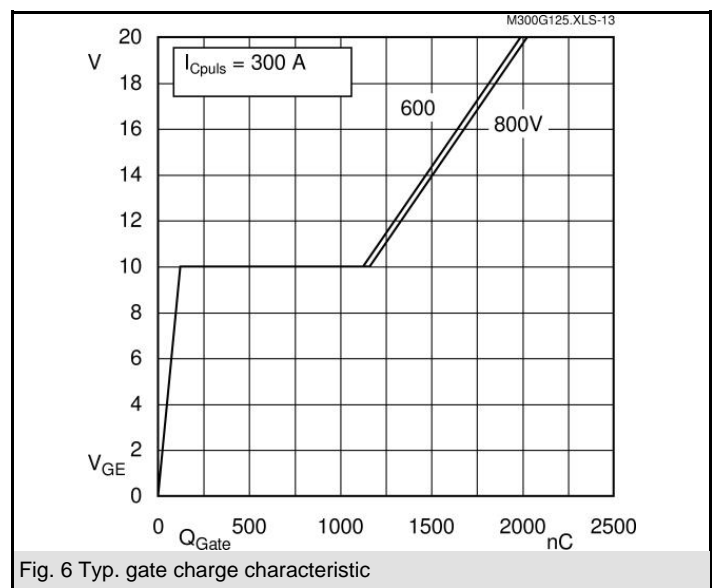
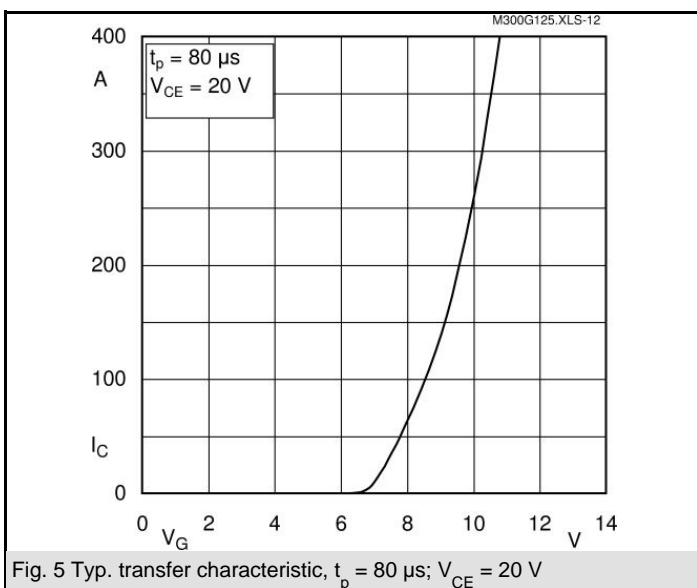
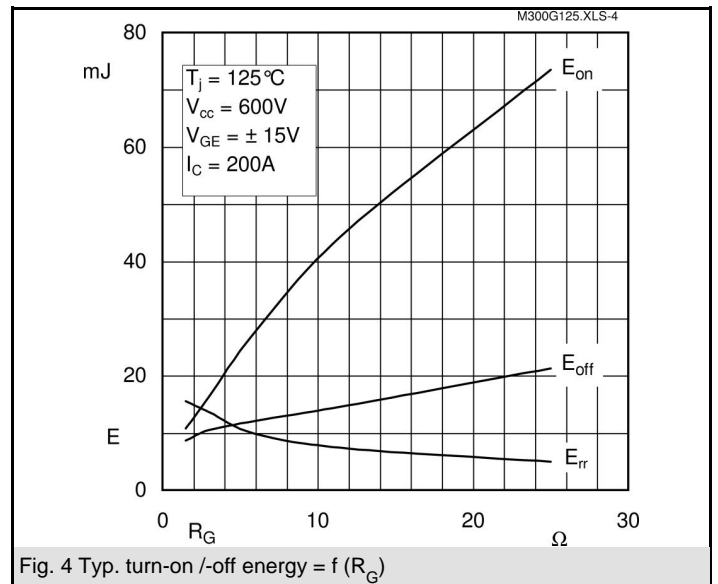
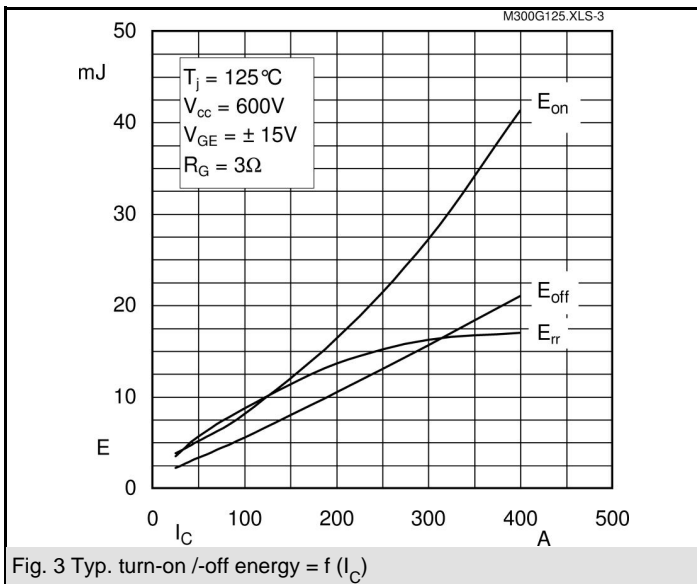
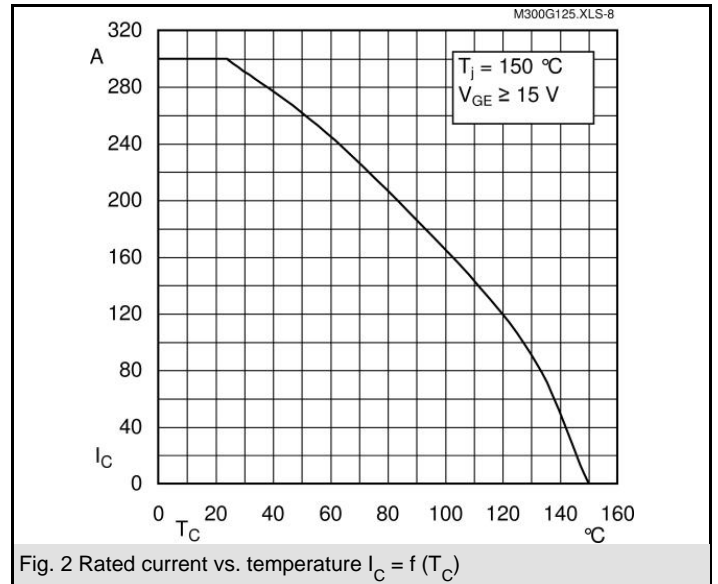
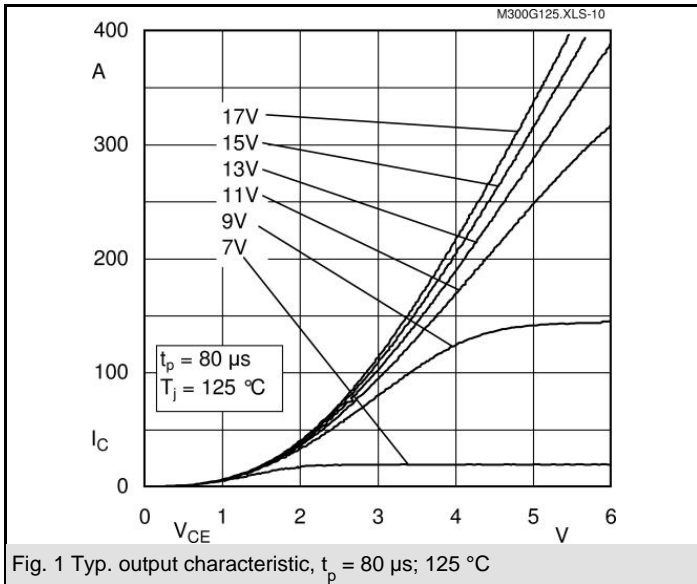

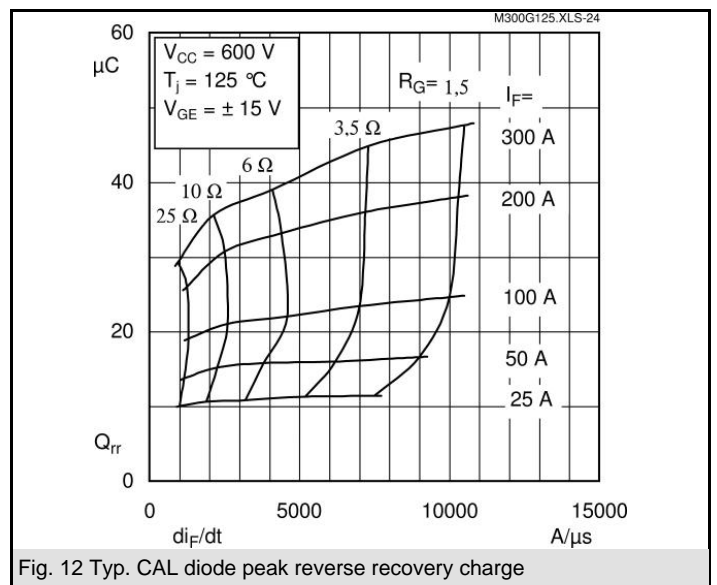
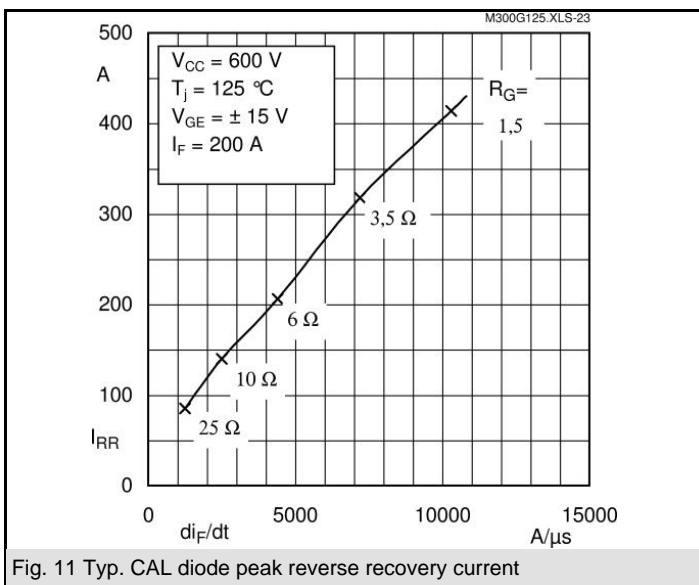
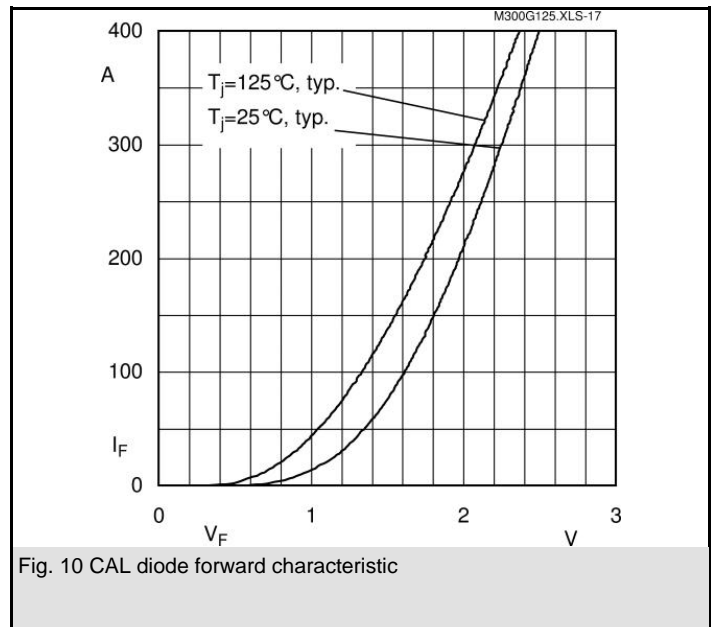
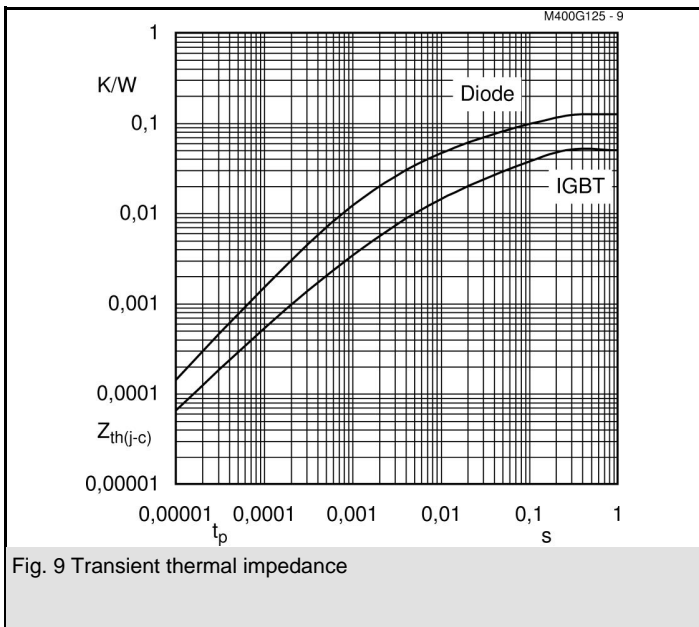
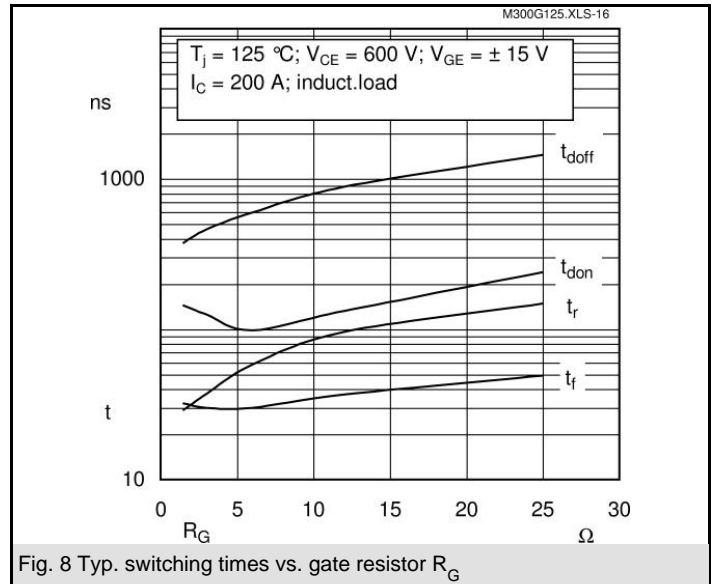
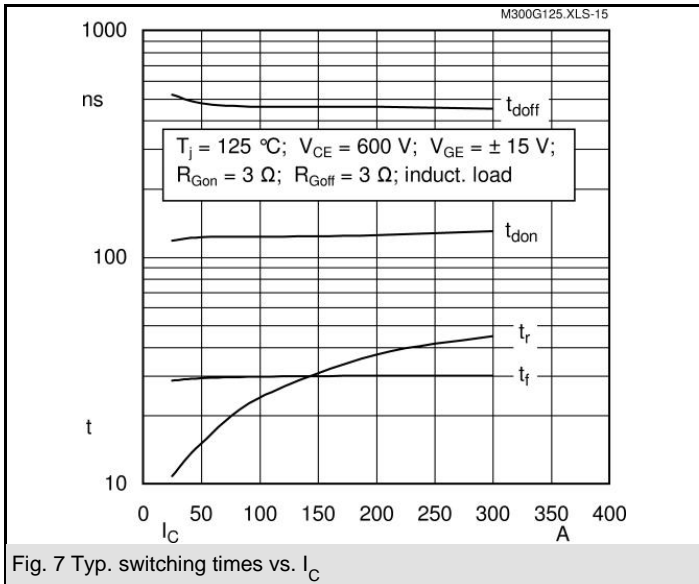

SKM 300GB125D

UL Recognized

CASED56

File 63 532

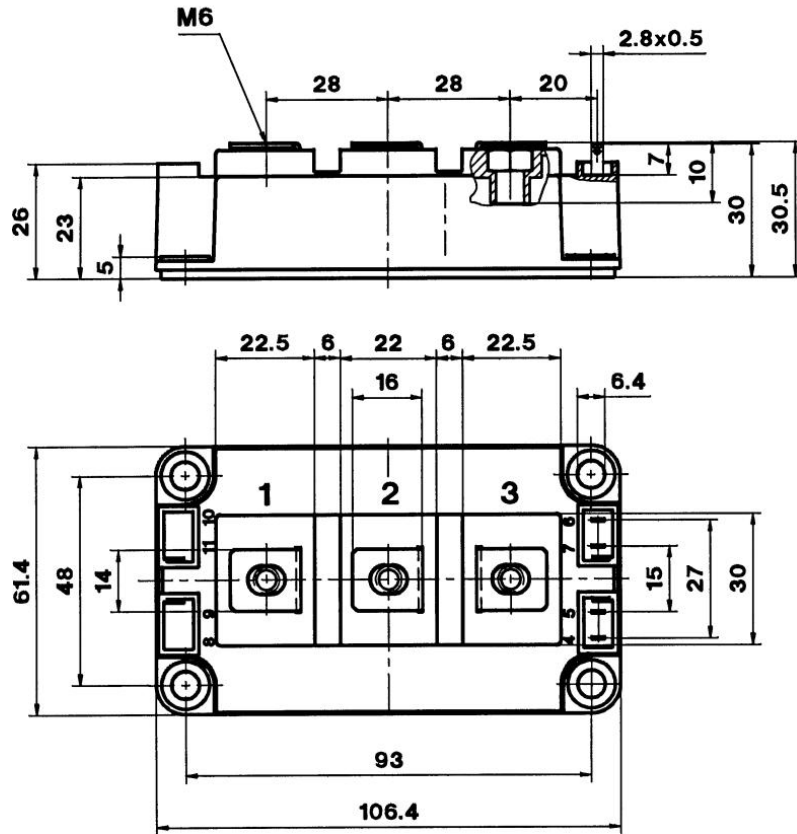

Case D 56

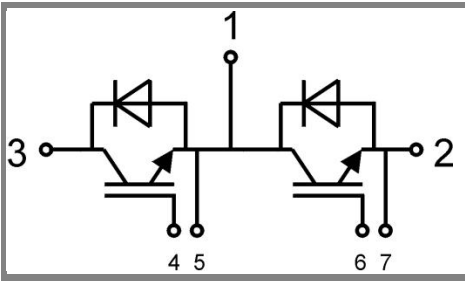

GB

Case D 56