

Silicon PNP Power Transistors

2SA1859 2SA1859A

DESCRIPTION

- With TO-220F package
- Complement to type 2SC4883/4883A

APPLICATIONS

- For audio output driver and TV velocity-modulation applications

PINNING

PIN	DESCRIPTION
1	Base
2	Collector
3	Emitter

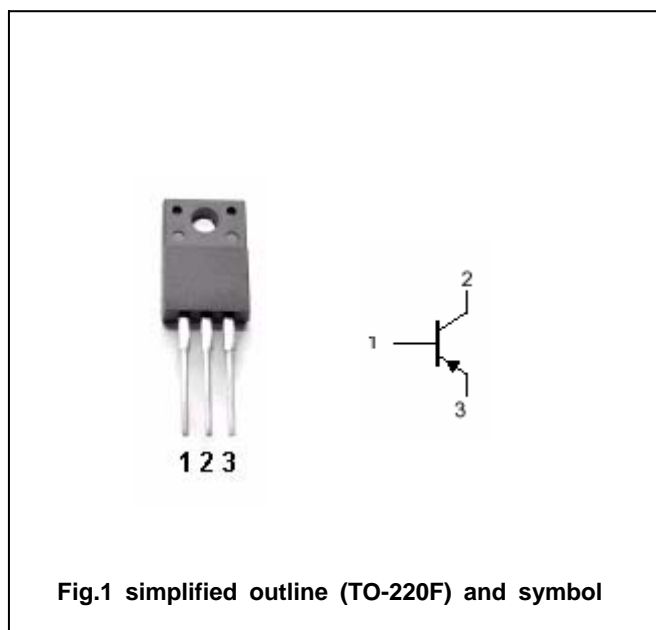

Fig.1 simplified outline (TO-220F) and symbol

Absolute maximum ratings (Ta=25°C)

SYMBOL	PARAMETER	CONDITIONS	VALUE	UNIT
V _{CB0}	Collector-base voltage	2SA1859	-150	V
		2SA1859A	-180	
V _{CEO}	Collector-emitter voltage	2SA1859	-150	V
		2SA1859A	-180	
V _{EBO}	Emitter-base voltage	Open collector	-6	V
I _C	Collector current		-2	A
I _B	Base current		-1	A
P _C	Collector dissipation	T _C =25°C	20	W
T _j	Junction temperature		150	°C
T _{stg}	Storage temperature		-55~150	°C

Silicon PNP Power Transistors

2SA1859 2SA1859A

CHARACTERISTICS

T_j=25°C unless otherwise specified

SYMBOL	PARAMETER		CONDITIONS	MIN	TYP.	MAX	UNIT
V _{(BR)CEO}	Collector-emitter breakdown voltage	2SA1859	I _C =-10mA ; I _B =0	-150			V
		2SA1859A		-180			
V _{CEsat}	Collector-emitter saturation voltage		I _C =-0.7A; I _B =-70mA			-1.0	V
I _{CBO}	Collector cut-off current	2SA1859	V _{CB} =-150V; I _E =0			-10	μ A
		2SA1859A	V _{CB} =-180V; I _E =0			-10	μ A
I _{EBO}	Emitter cut-off current		V _{EB} =-6V; I _C =0			-10	μ A
h _{FE}	DC current gain		I _C =-0.7A ; V _{CE} =-10V	60		240	
f _T	Transition frequency		I _C =-0.7A ; V _{CE} =-12V		60		MHz
C _{OB}	Output capacitance		I _E =0 ; V _{CB} =-10V; f=1MHz		30		pF

Switching time

t _{on}	Turn-on time	I _C =-1A ; I _{B1} =-I _{B2} =-0.1A V _{CC} =-20V , R _L =20 Ω		0.50		μ s
t _s	Storage time			1.00		μ s
t _f	Fall time			0.50		μ s

Silicon PNP Power Transistors

2SA1859 2SA1859A

PACKAGE OUTLINE

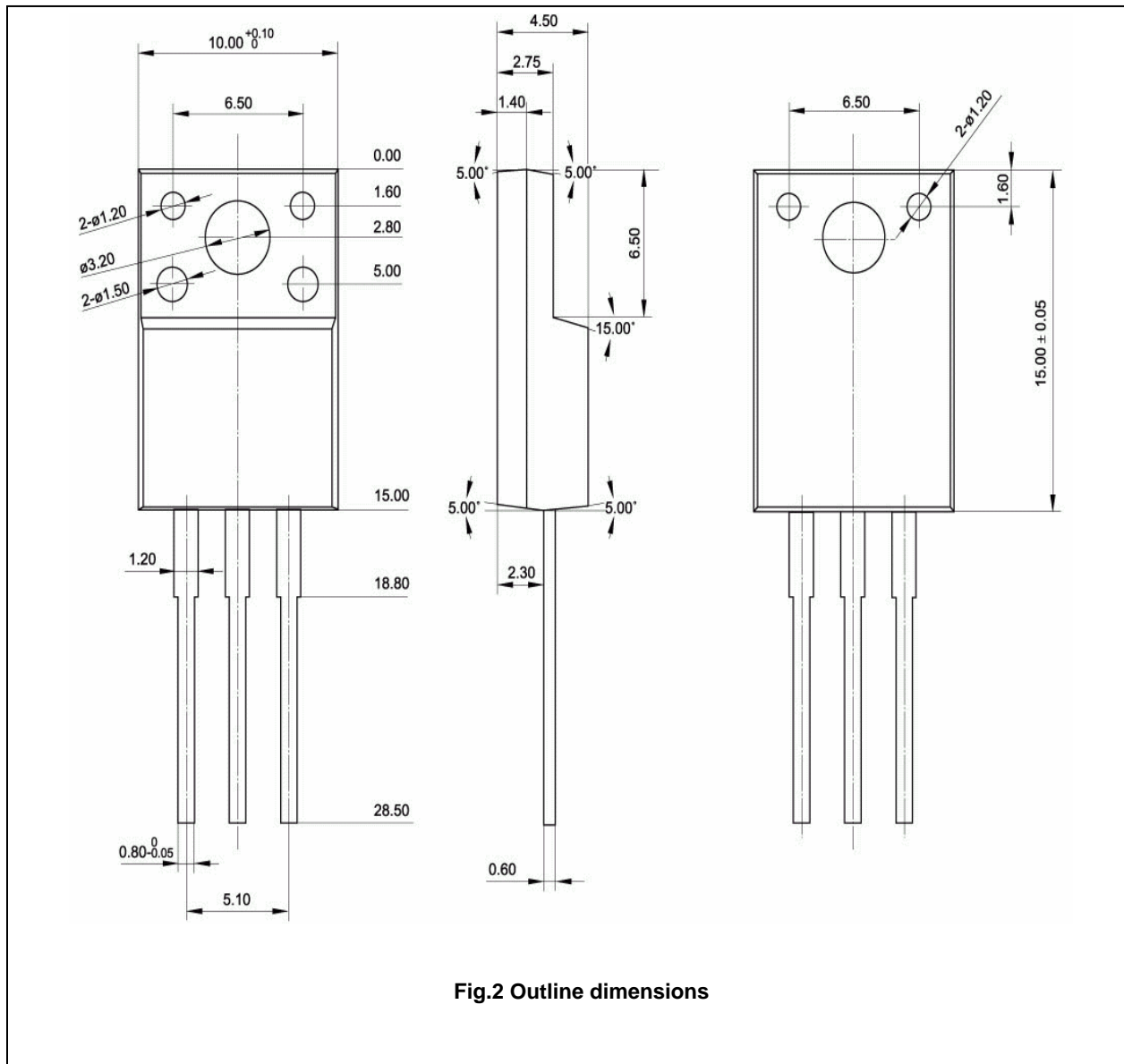

Fig.2 Outline dimensions

Silicon PNP Power Transistors

2SA1859 2SA1859A

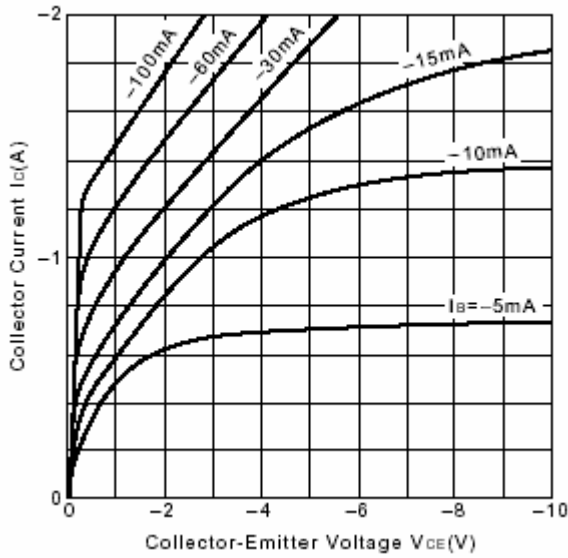

Fig.3 Static Characteristic

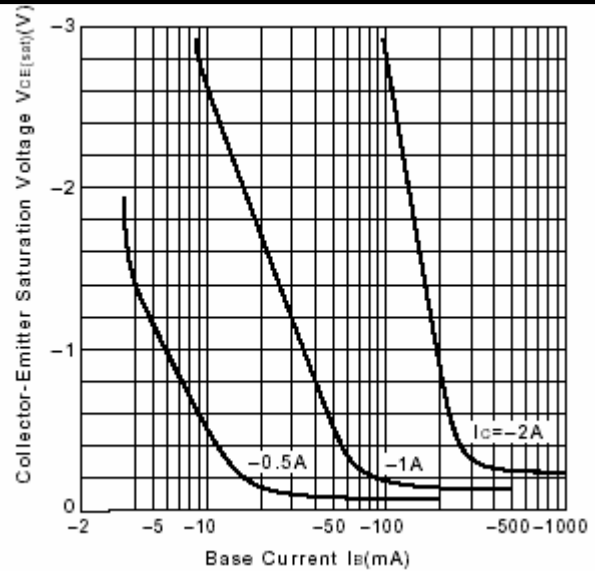

Fig.4 $V_{CE(sat)}-I_B$ Characteristics

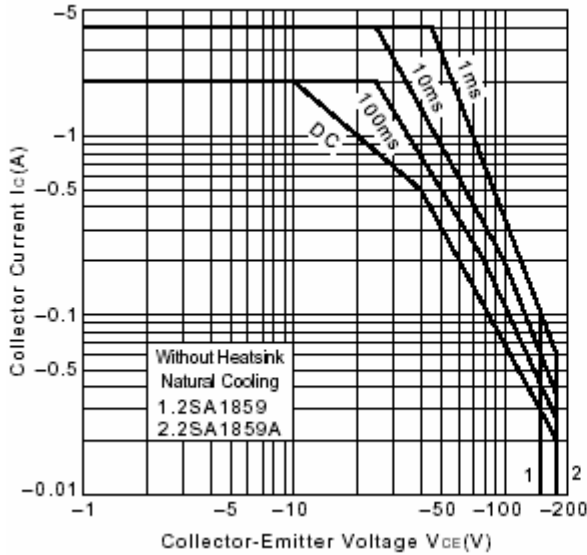

Fig.5 Safe Operating Area

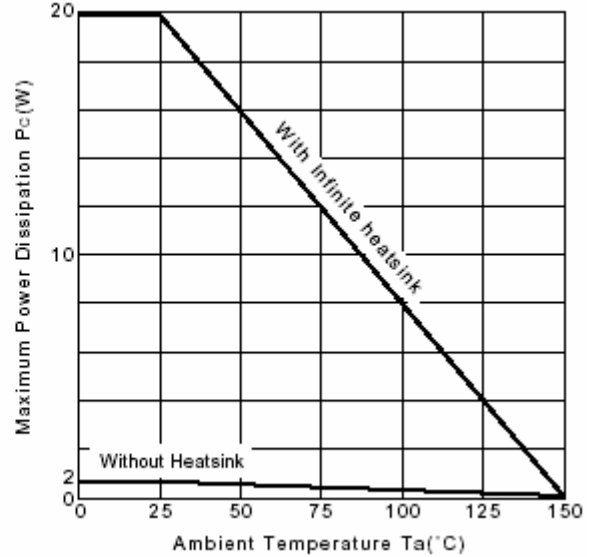

Fig.6 Power Derating

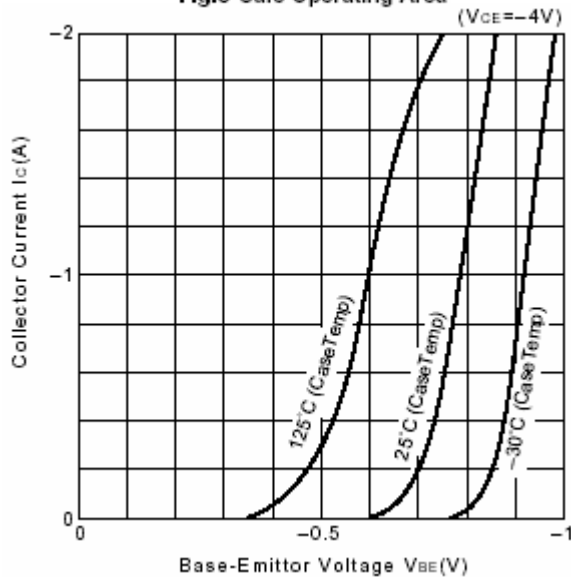

Fig.7 I_C-V_{BE}

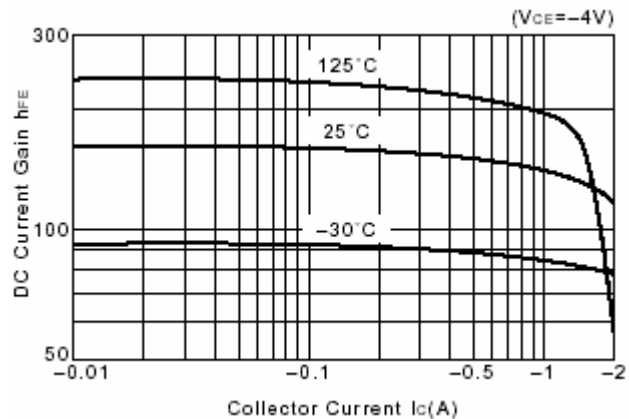

Fig.8 DC current Gain