

Cylindrical Type LED lamp
BL-L542
Features:

- 5mm Cylindrical LED lamp, FLAT TOP
- Ultra brightness.
- Choice of various viewing angles.
- Diffused, Transparent and Water clear lens
- IC compatible /Low current capability.
- RoHs Compliance

Electrical-optical characteristics: (Ta=25°C) (Test Condition: IF=20mA)

Part Number	Chip			Lens Type	Forward Voltage(VF) Unit:V		Luminous Intensity (lv) Unit:mcd		Viewing Angle 201/2(deg)
	Emitted Color	Material	λ_p (nm)		Typ	Max	Min.	Typ.	
					BL-L542SRC	Hi Red	AlGaAs,SH	660	
BL-L542LRC	Super Red	AlGaAs,DH	660	1.85	2.20	270	500		
BL-L542URC	Ultra Red	AlGaAs,DDH	660	1.95	2.20	500	800		
BL-L542UEC	Ultra Orange	AlGaInP	630	2.10	2.50	260	600		
BL-L542UYC	Ultra Yellow	AlGaInP	590	2.10	2.50	260	500		
BL-L542UGC	Ultra Green	AlGaInP	574	2.20	2.50	120	250		
BL-L542PGC	Ultra Pure Green	InGaN	525	3.80	4.50	800	2000		
BL-L542BGC	Ultra Bluish Green	InGaN	505	3.80	4.50	700	1800		
BL-L542BC	Blue	InGaN	430	3.80	4.50	500	1000		
BL-L542UBC	Ultra Blue	InGaN	470	2.70	4.20	650	1800		
BL-L542VC	UV	InGaN	405	3.80	4.50	35	80		
BL-L542UWC	Ultra White	InGaN	/	2.70	4.20	1000	2500		

Absolute maximum ratings (Ta=25°C)

Parameter	SR	LR	UR	UE	UY	UG	PG	BG	B	UB	UV	W	Unit
Forward Current I_F	25	25	25	30	30	30	30	30	30	30	30	30	mA
Power Dissipation P_d	60	60	60	65	65	75	110	110	120	120	120	120	mW
Reverse Voltage V_R	5	5	5	5	5	5	5	5	5	5	5	5	V
Peak Forward Current I_{PF} (Duty 1/10 @1KHZ)	150	150	150	150	150	150	150	100	100	100	100	100	mA
Operation Temperature T_{OPR}	-40 to +80												°C
Storage Temperature T_{STG}	-40 to +85												°C
Lead Soldering Temperature T_{SOL}	Max.260±5°C for 3 sec Max. (1.6mm from the base of the epoxy bulb)												°C

Cylindrical Type LED lamp

BL-L542

■ Package configuration & Internal circuit diagram

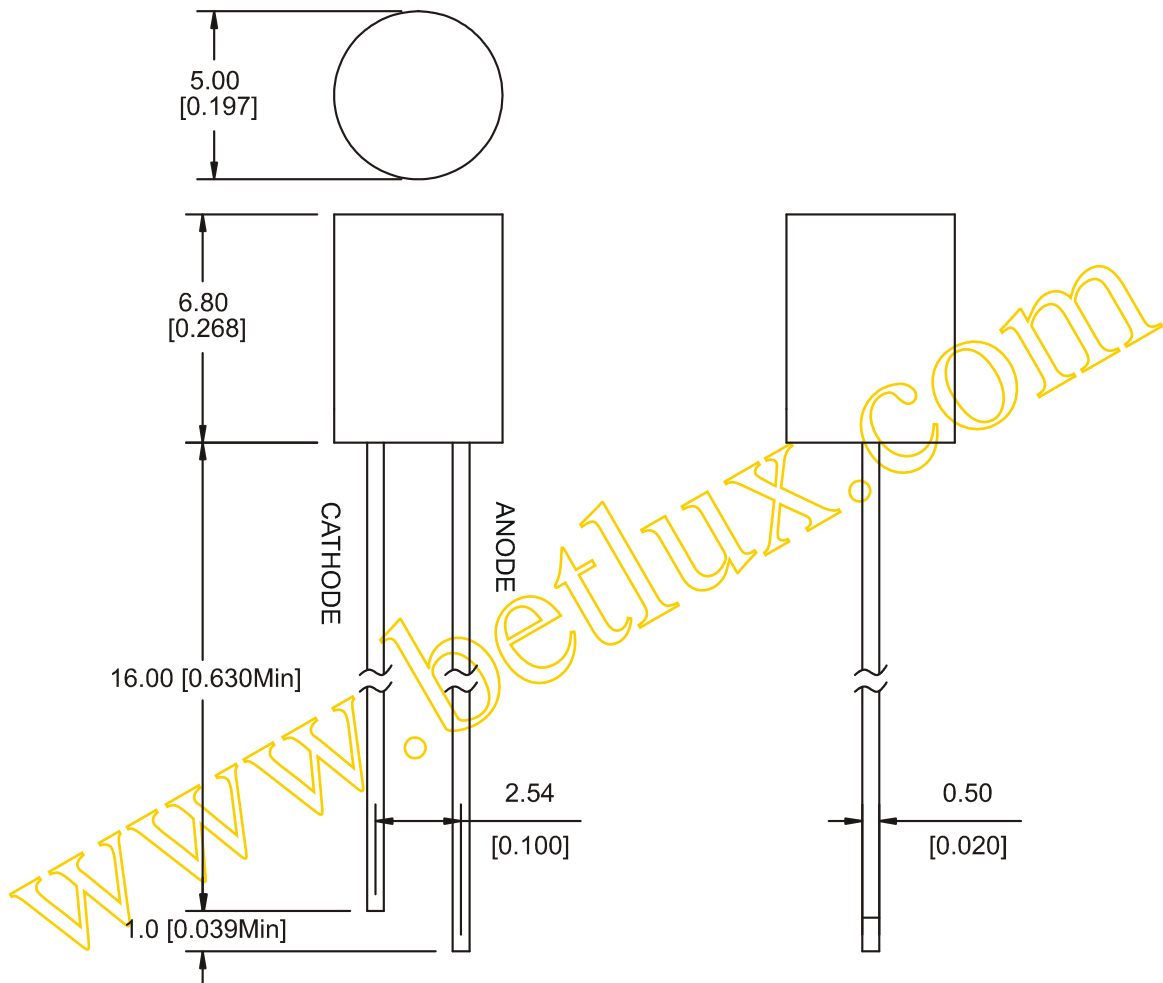

Notes:

1. All dimensions are in millimeters (inches)
2. Tolerance is $\pm 0.25(0.01)$ unless otherwise noted.
3. Specifications are subject to change without notice.

Cylindrical Type LED lamp

BL-L542

Typical electrical-optical characteristics curves:



- | | |
|---|--------------------------------------|
| (1) - GaAsP/GaAs 655nm/Red | (9) - GaAlAs 880nm |
| (2) - GaP 570nm/Yellow Green | (10) - GaAs/GaAs & GaAlAs/GaAs 940nm |
| (3) - GaAsP/GaP 585nm/Yellow | (A) - GaN/SiC 430nm/Blue |
| (4) - GaAsP/GaP 635nm/Orange & Hi-Eff Red | (B) - InGaN/SiC 470nm/Blue |
| (5) - GaP 700nm/Bright Red | (C) - InGaN/SiC 505nm/Ultra Green |
| (6) - GaAlAs/GaAs 660nm/Super Red | (D) - InGaN/SiC 525nm/Ultra Green |
| (8) - GaAsP/GaP 610nm/Super Red | |

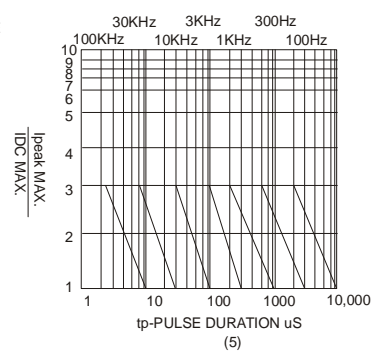
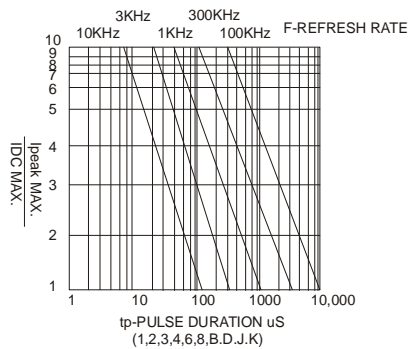
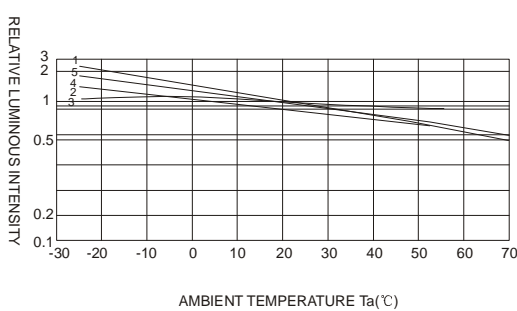
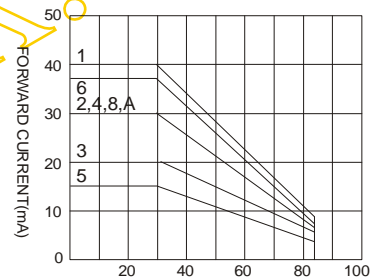
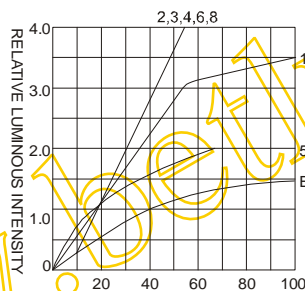
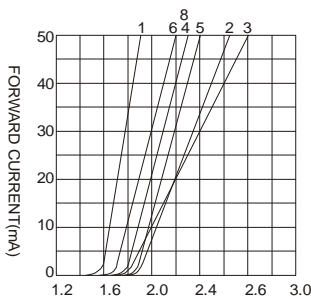

NOTE:25°C free air temperature unless otherwise specified