

## NON-ISOLATED DC/DC CONVERTERS

10.8 Vdc - 13.2 Vdc Input, 1.23, 2.5, 3.3, -12 Vdc/6, 1.5, 1.5, 2 A



Sep. 22, 2009

Bel Power, Inc., a subsidiary of Bel Fuse, Inc.

SRXA-40AQ1L

RoHS Compliant

Rev.C

### Features

- Non-Isolated
- High Efficiency
- Fixed Frequency
- High Power Density
- Wide Input
- Class 1, Category 2, Non-Isolated DC/DC Converter (refer to IPC-9592)
- Low Cost
- Under Voltage Lockout
- OCP/SCP
- Remote On/Off
- Wide Operating Temperature Range

### Applications

- Networking
- Computers and peripherals
- Telecommunications

### Description

The Bel SRXA-40AQ1L is part of the non-isolated dc/dc converter Power Module series. The modules use a SMT package. These converters provide 4 outputs: 1.23 Vdc/6 A, 2.5 Vdc/1.5 A, 3.3 Vdc/1.5 A and -12 Vdc/2 A over a wide range of input voltage ( $V_{in} = 10.8 - 13.2$  Vdc). The efficiency is typically 91% @ 12Vin at full load.

### Part Selection

Output Voltage	Input Voltage	Max. Output Current	Max. Output Power	Typical Efficiency	Model Number Active Low
1.23/ 2.5/ 3.3/ -12 Vdc	10.8 Vdc - 13.2 Vdc	6/ 1.5/ 1.5/ 2 A	40 W	91%	SRXA-40AQ1L

**Notes:** Add "G" suffix at the end of the model number to indicate Tray Packaging.

### Part Number Explanation

$\frac{S}{1} \frac{R}{2} \frac{XA}{3} - \frac{40}{4} \frac{A}{5} \frac{Q1}{6} \frac{L}{7}$

- 1---Surface mount
- 2---RoHS 6, change "R" to "7" means RoHS 5
- 3---Series name
- 4---Series code
- 5--- Narrow input range (10.8-13.2V)
- 6---Output voltage, Quad
- 7---Enable, active low

## NON-ISOLATED DC/DC CONVERTERS

10.8 Vdc - 13.2 Vdc Input, 1.23, 2.5, 3.3, -12 Vdc/6, 1.5, 1.5, 2 A



Sep. 22, 2009

Bel Power, Inc., a subsidiary of Bel Fuse, Inc.

### Absolute Maximum Ratings

Parameter	Min	Typ	Max	Unit	Notes
Continuous non-operating Input Voltage	-0.3	-	15	V	
Remote On/Off	-0.3	-	15	V	
Ambient Temperature	-40	-	85	°C	
Storage Temperature	-55	-	125	°C	

**Note:** Ratings used beyond the maximum ratings may cause a reliability degradation of the converter or may permanently damage the device.

### Input Specifications

Parameter	Min	Typ	Max	Unit	Notes
Operating Input Voltage	10.8	12	13.2	V	
Input Current (full load)	-	-	5	A	
Input Current (no load)	-	80	150	mA	
Remote Off Input Current	-	10	-	mA	
Input Reflected Ripple Current (rms)	-	10	20	mA	Use a 1000uF AL-Cap on the input
Input Reflected Ripple Current (pk-pk)	-	50	80	mA	
I <sup>2</sup> t Inrush Current Transient	-	-	1	A <sup>2</sup> s	
Turn-on Voltage Threshold	-	10.5	-	V	
Turn-off Voltage Threshold	-	9.5	-	V	

**CAUTION:** This converter is not internally fused. An input line fuse must be used in application.

Recommend a fast-acting fuse with maximum rating of 8A on system board. Refer to the fuse manufacturer's datasheet for further information.

**Note:** All specifications are typical at 25 °C unless otherwise stated.

### Output Specifications

Parameter	Min	Typ	Max	Unit	Notes
Output Voltage Set Point	-2	-	2	% Vo,set	Vin=12V, Iout=half load
Load Regulation	-	-	1	% Vo,set	
Line Regulation	-	-	1	% Vo,set	
Regulation Over Temperature (-40deg.C-85deg.C)	-	-	1	% Vo,set	
Ripple and Noise (pk-pk)					0-20MHz BW, minimum extra output ceramic caps on output
Vo=1.23V	-	30	-	mV	
Vo=2.5V	-	30	-	mV	
Vo=3.3V	-	30	-	mV	
Vo=-12V	-	40	-	mV	
Ripple and Noise (rms)					
Vo=1.23V	-	5	-	mV	
Vo=2.5V	-	5	-	mV	
Vo=3.3V	-	5	-	mV	
Vo=-12V	-	8	-	mV	

# NON-ISOLATED DC/DC CONVERTERS

10.8 Vdc - 13.2 Vdc Input, 1.23, 2.5, 3.3, -12 Vdc/6, 1.5, 1.5, 2 A



Sep. 22, 2009

Bel Power, Inc., a subsidiary of Bel Fuse, Inc.

## Output Specifications (continued)

Parameter	Min	Typ	Max	Unit	Notes		
Output Current Range							
Vo=1.23V	0	-	6	A			
Vo=2.5V	0	-	1.5	A			
Vo=3.3V	0	-	1.5	A			
Vo=-12V	0	-	2	A			
Output DC Current Limit <sup>1</sup>	-	150	-	%Iout			
Short Circuit Surge Transient	-	1	3	A <sup>2</sup> s			
Turn on Time	-	8	12	mS			
Overshoot at Turn on	-	-	5	%			
Output Capacitance							
Vo=1.23V	330	-	560	uF			
Vo=2.5V	220	-	470	uF			
Vo=3.3V	80	-	220	uF			
Vo=-12V	22	-	100	uF			
<b>Transient Response</b>							
ΔV 50%~75% of Max Load	Overshoot	Vo= 1.23V	-	50	100	mV	di/dt=0.5A/us, Vin=12.0Vdc, Ta=25°C, minimum extra output ceramic caps on output
	Settling Time		-	-	150	uS	
ΔV 75%~50% of Max Load	Overshoot	Vo= 2.5V	-	50	100	mV	
	Settling Time		-	-	150	uS	
ΔV 50%~75% of Max Load	Overshoot	Vo= 3.3V	-	50	100	mV	
	Settling Time		-	-	150	uS	
ΔV 75%~50% of Max Load	Overshoot	Vo= -12V	-	50	100	mV	
	Settling Time		-	-	150	uS	
ΔV 50%~75% of Max Load	Overshoot	Vo= -12V	-	200	400	mV	
	Settling Time		-	-	150	uS	
ΔV 75%~50% of Max Load	Overshoot	Vo= -12V	-	200	400	mV	
	Settling Time		-	-	150	uS	

- Notes:**
1. All outputs is shutdown latched when 3.3V, 2.5V, 1.23V output happen overload. Hiccup mode is active during -12V output overload but 3.3V, 2.5V and 1.23V don't be affected operating.
  2. All specifications are typical at nominal input, full load at 25°C unless otherwise stated.

# NON-ISOLATED DC/DC CONVERTERS

10.8 Vdc - 13.2 Vdc Input, 1.23, 2.5, 3.3, -12 Vdc/6, 1.5, 1.5, 2 A



Sep. 22, 2009

Bel Power, Inc., a subsidiary of Bel Fuse, Inc.

## General Specifications

Parameter	Min	Typ	Max	Unit	Notes
Efficiency	-	91	-	%	Vin=12.0V, full load
Switching Frequency	-	300	-	kHz	
Weight	-	14	-	g	
FIT	TBD			-	Calculated Per Bell Core SR-332 (Io=80%load, Ta = 25 °C, FIT=10 <sup>9</sup> /MTBF)
Dimensions				-	
Inches (L x W x H)	1.77 x 0.90 x 0.49				
Millimeters (L x W x H)	45.00 x 22.86 x 12.39				

**Note:** All specifications are typical at 25 °C unless otherwise stated.

## Efficiency Data

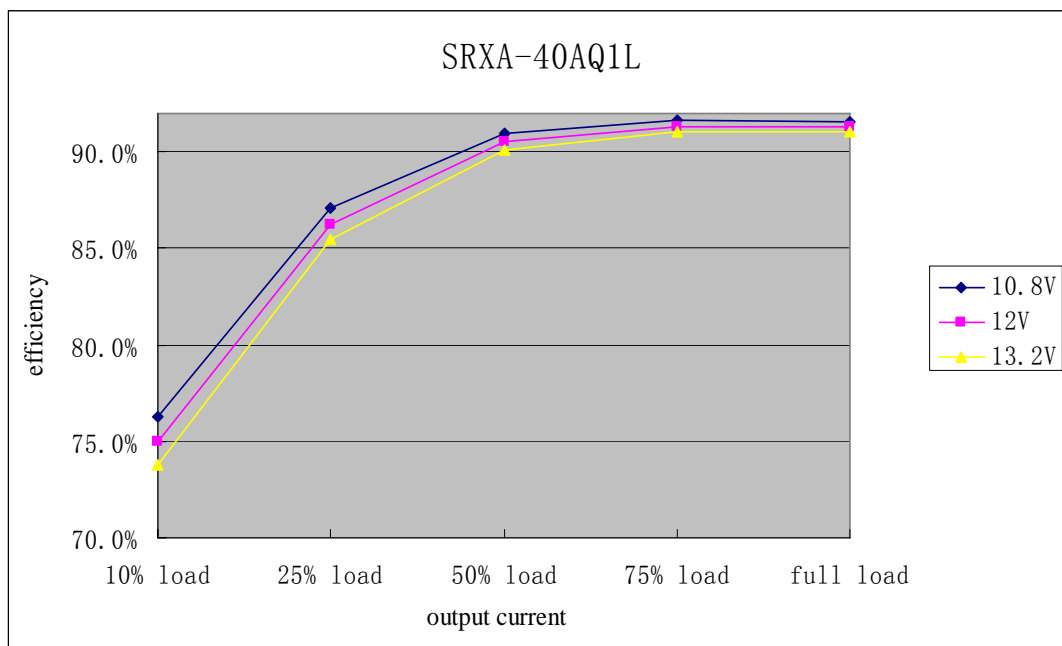

# NON-ISOLATED DC/DC CONVERTERS

10.8 Vdc - 13.2 Vdc Input, 1.23, 2.5, 3.3, -12 Vdc/6, 1.5, 1.5, 2 A



Sep. 22, 2009

Bel Power, Inc., a subsidiary of Bel Fuse, Inc.

## Thermal Derating Curves

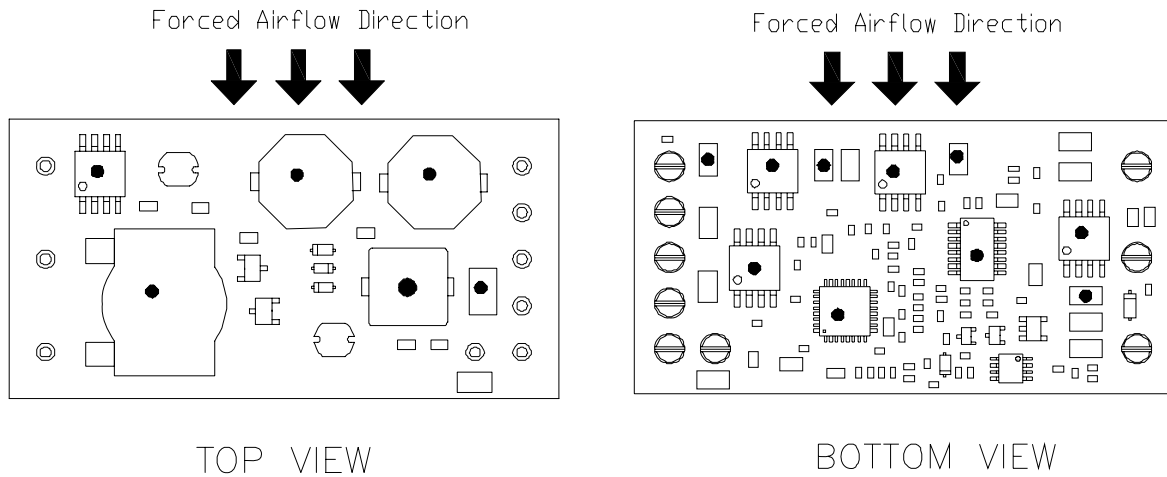

The thermal reference point is shown above. For reliable operation this temperature should not exceed 110°C. The output power of the module should not exceed the rated power for the module.

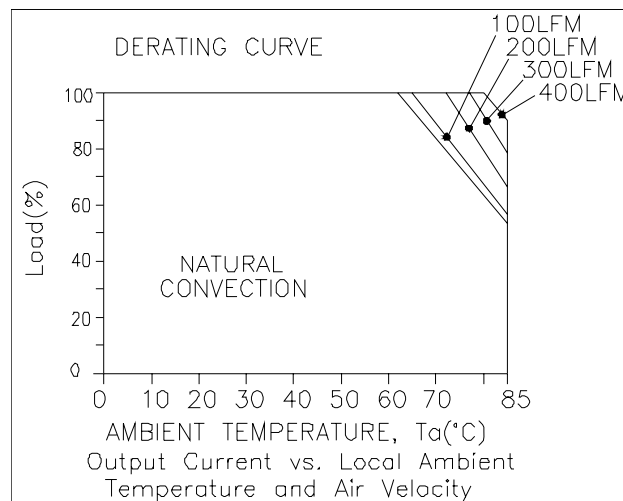

Derating curve under normal input

Maximum junction temperature of semiconductors derated to 120 degree C.

# NON-ISOLATED DC/DC CONVERTERS

10.8 Vdc - 13.2 Vdc Input, 1.23, 2.5, 3.3, -12 Vdc/6, 1.5, 1.5, 2 A



Sep. 22, 2009

Bel Power, Inc., a subsidiary of Bel Fuse, Inc.

## Ripple and Noise Waveform

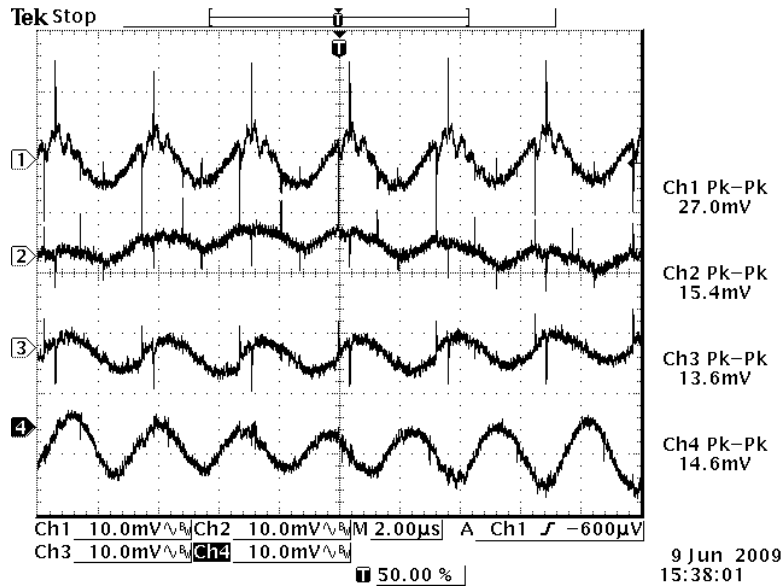

## Transient Response Waveforms

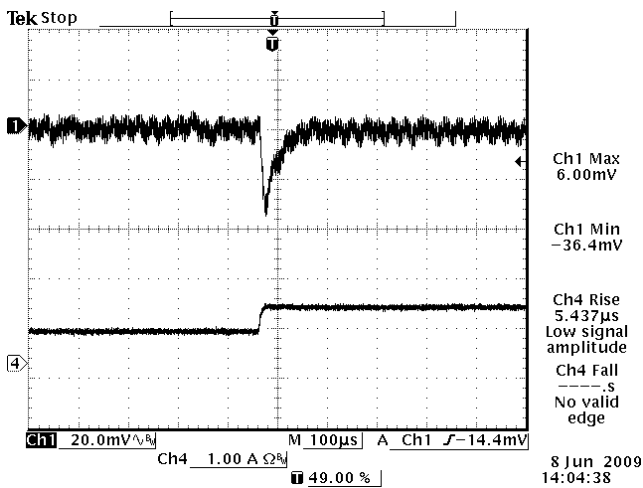

3.3Vout 50%-75%load 0.5A/us

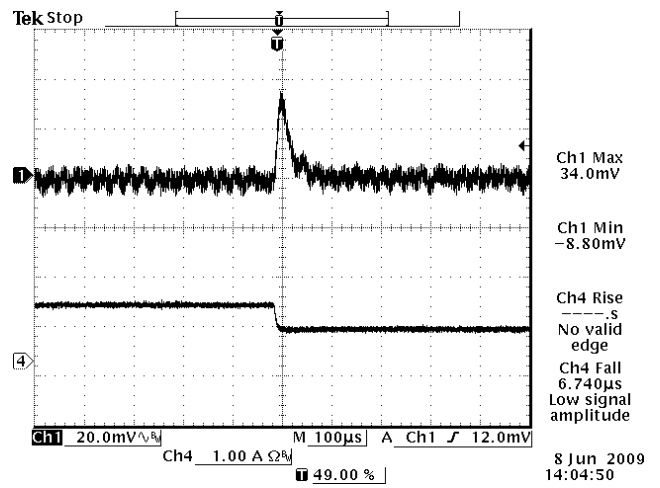

3.3Vout 75%-50%load 0.5A/us

# NON-ISOLATED DC/DC CONVERTERS

10.8 Vdc - 13.2 Vdc Input, 1.23, 2.5, 3.3, -12 Vdc/6, 1.5, 1.5, 2 A



Sep. 22, 2009

Bel Power, Inc., a subsidiary of Bel Fuse, Inc.

## Transient Response Waveforms (continued)

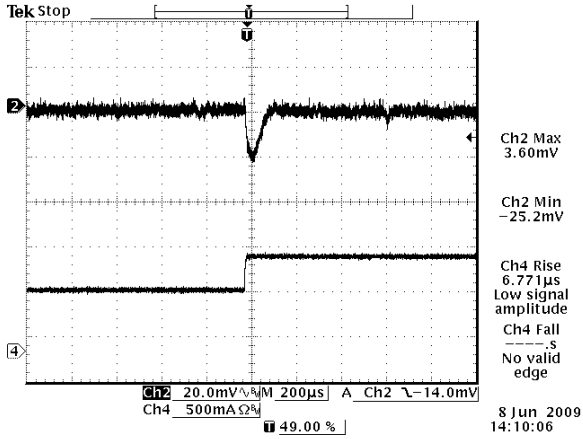

2.5Vout 50%-75%load 0.5A/us

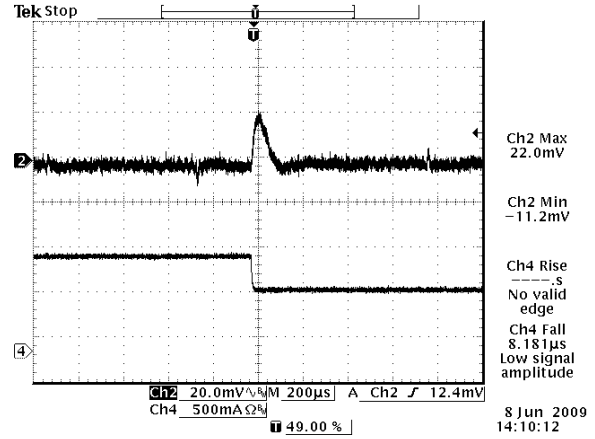

2.5Vout 75%-50%load 0.5A/us

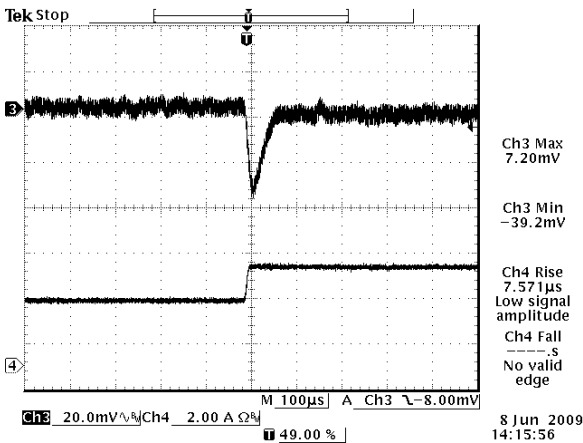

1.23Vout 50%-75%load 0.5A/us

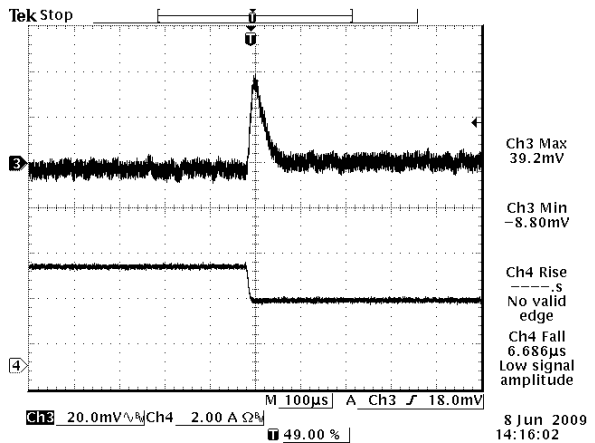

1.23Vout 75%-50%load 0.5A/us

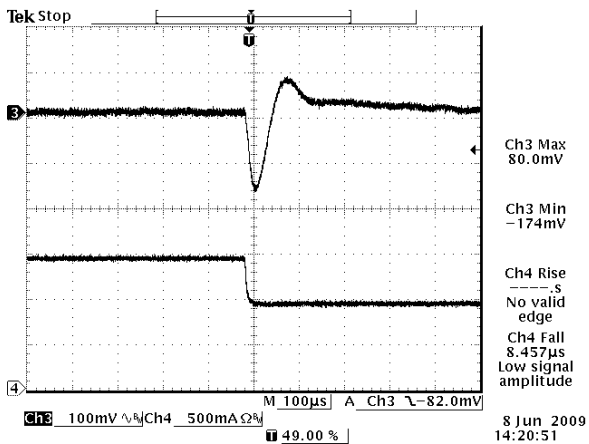

-12Vout 50%-75%load 0.5A/us

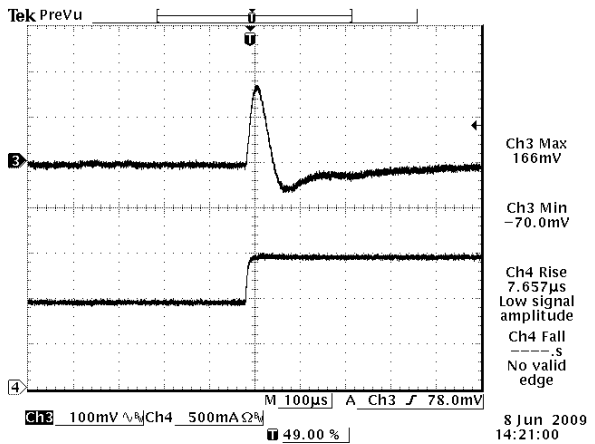

-12Vout 75%-50%load 0.5A/us

# NON-ISOLATED DC/DC CONVERTERS

10.8 Vdc - 13.2 Vdc Input, 1.23, 2.5, 3.3, -12 Vdc/6, 1.5, 1.5, 2 A



Sep. 22, 2009

Bel Power, Inc., a subsidiary of Bel Fuse, Inc.

## Startup & Shutdown

### Rise time

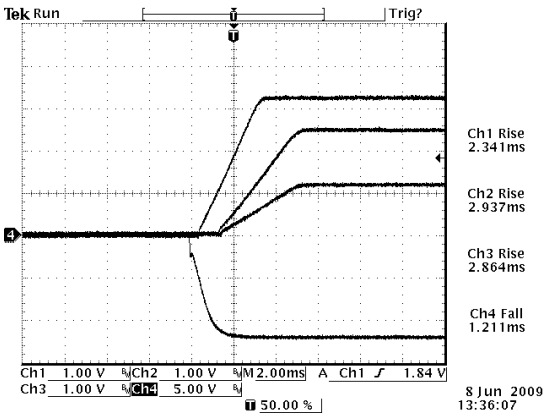

Test Condition:  
Vin=12V, full load output

### Startup time

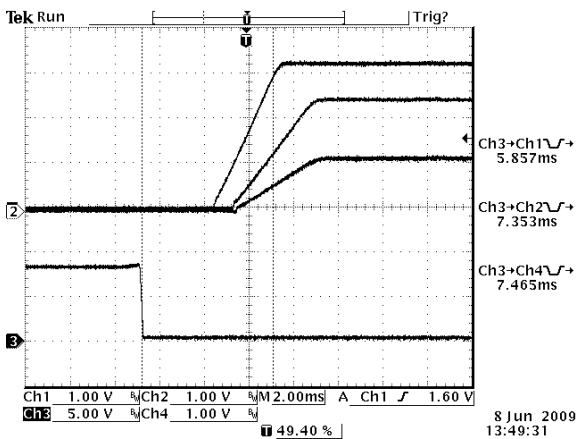

Startup from on/off  
Ch1,Ch2,Ch4: 1.23Vout,2.5Vout,3.3Vout  
CH3: on/off controller  
Vin=12V, full load output

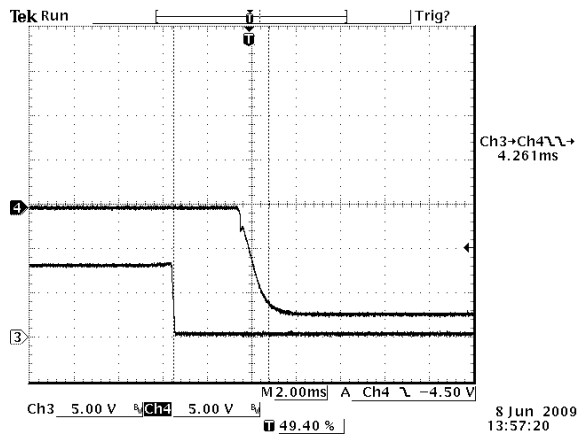

Startup from on/off  
Ch4: -12Vout  
Ch3: on/off controller  
Vin=12V, full load output

### Shutdown

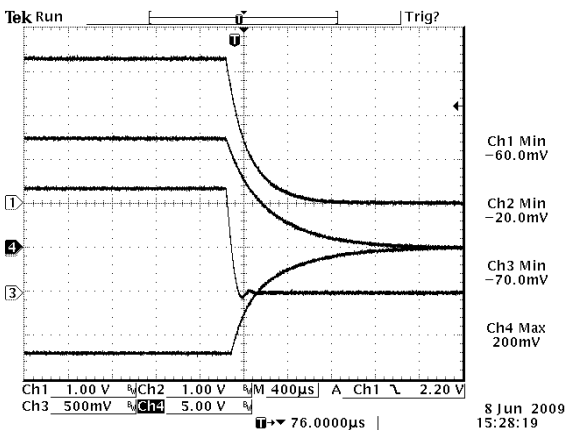

Test Condition:  
Vin=12V, full load output



# NON-ISOLATED DC/DC CONVERTERS

10.8 Vdc - 13.2 Vdc Input, 1.23, 2.5, 3.3, -12 Vdc/6, 1.5, 1.5, 2 A



Sep. 22, 2009

Bel Power, Inc., a subsidiary of Bel Fuse, Inc.

## Remote On/Off

Parameter		Min	Typ	Max	Unit	Notes
Signal Low (Unit On)	Active Low	-0.3	-	1	V	The remote on/off pin open, Unit off.
Signal High (Unit Off)		2.5	-	V <sub>in</sub>	V	
Current Sink		0	-	1	mA	

### Recommended remote on/off circuit for active low

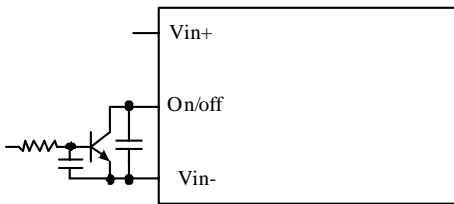

Control with open collector/drain circuit

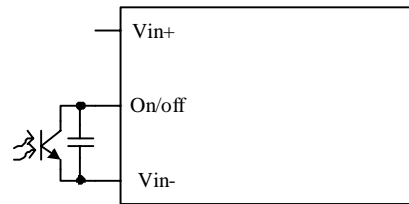

Control with photocoupler circuit

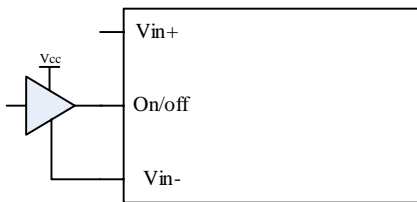

Control with logic circuit

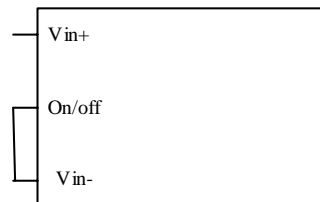

Permanently on

## Input Under-voltage Lockout

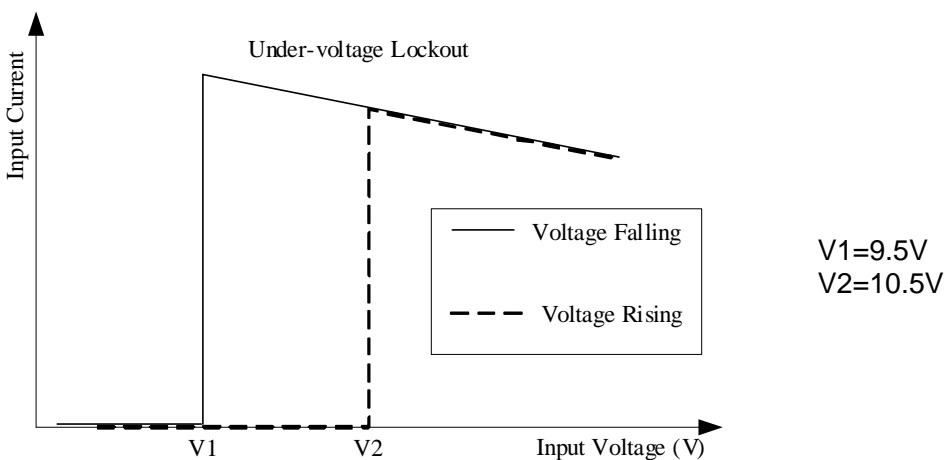

## NON-ISOLATED DC/DC CONVERTERS

10.8 Vdc - 13.2 Vdc Input, 1.23, 2.5, 3.3, -12 Vdc/6, 1.5, 1.5, 2 A



Sep. 22, 2009

Bel Power, Inc., a subsidiary of Bel Fuse, Inc.

### Power Sequence

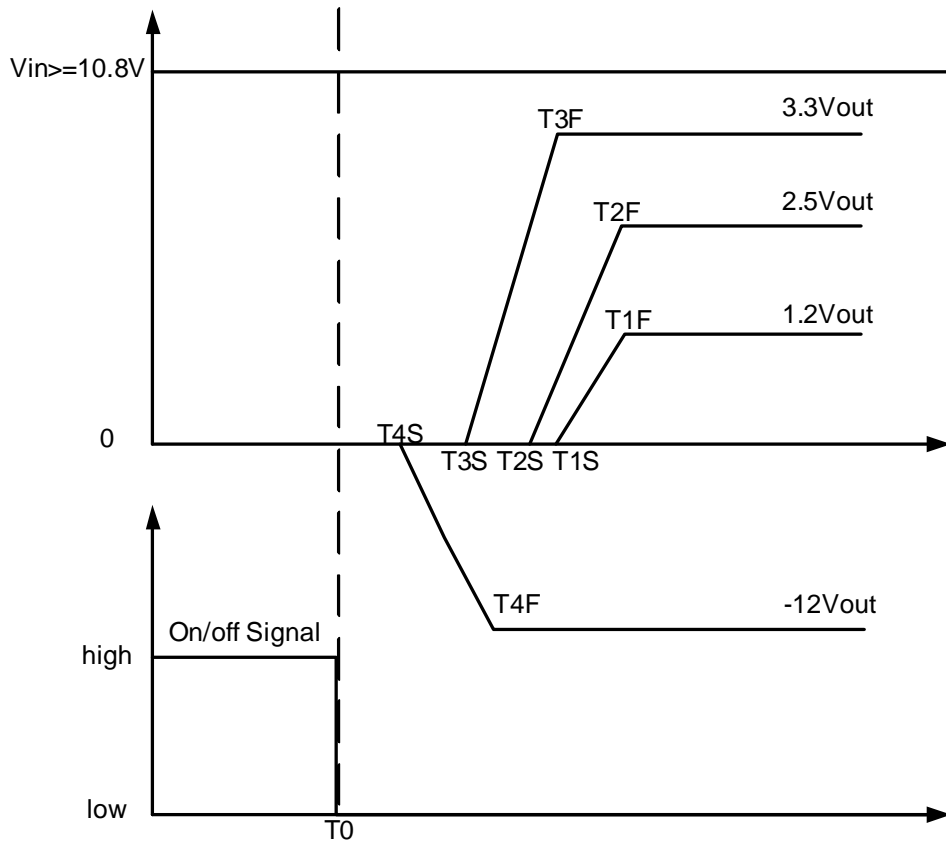

$$T1F-T0 < 12mS$$

$$T4F-T0 < 5mS$$

$$T1S-T3S < 10mS$$

$$\text{Max}(T3F, T2F, T1F) - T3S < 10mS$$

$$\text{Max}[(T3F-T3S), (T2F-T2S), (T1F-T1S)] < 5mS$$

$$\text{Min}[3.3V/(T3F-T3S), 2.5V/(T2F-T2S), 1.2V/(T1F-T1S)] < 100mV/us$$

$$3.3V_{out}(t) > 2.5V_{out}(t) > 1.2V_{out}(t), \text{ when } t > T3S$$

# NON-ISOLATED DC/DC CONVERTERS

10.8 Vdc - 13.2 Vdc Input, 1.23, 2.5, 3.3, -12 Vdc/6, 1.5, 1.5, 2 A



Sep. 22, 2009

*Bel Power, Inc. , a subsidiary of Bel Fuse, Inc.*

## Fundamental Circuit Diagram

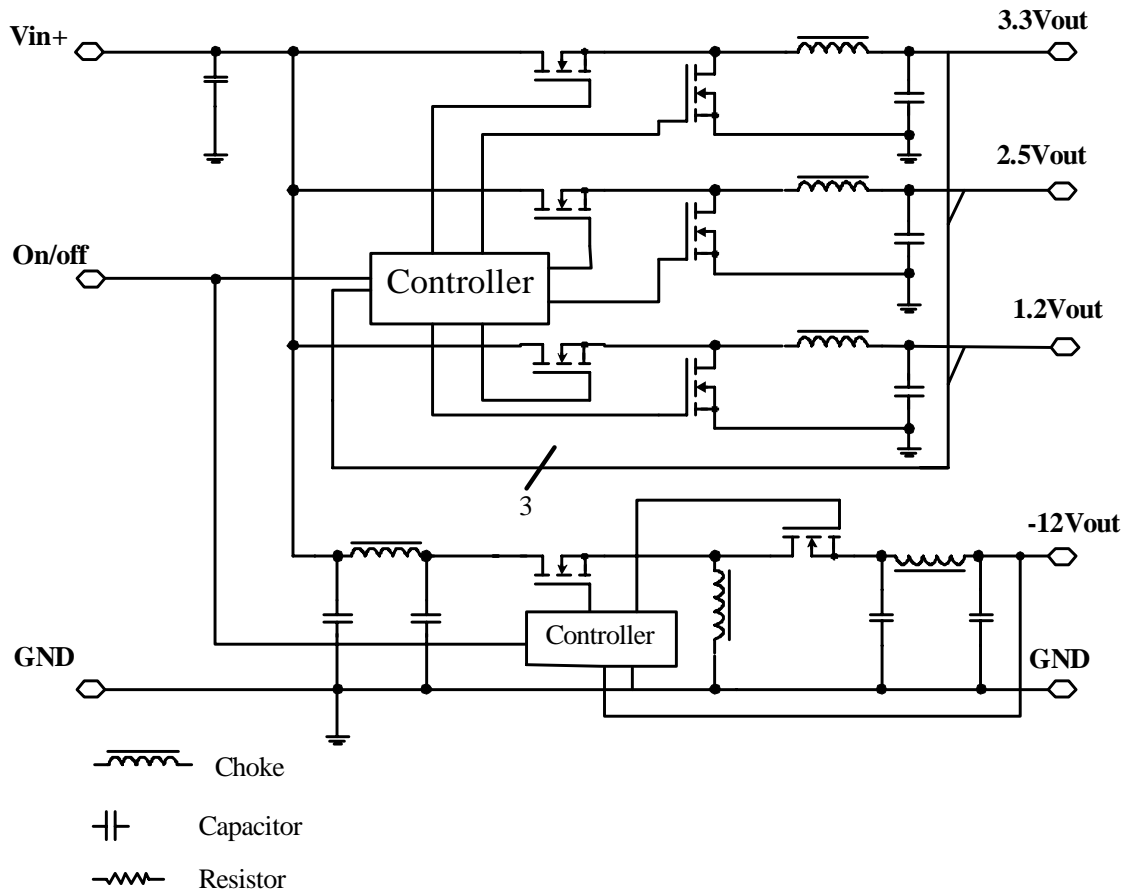

# NON-ISOLATED DC/DC CONVERTERS

10.8 Vdc - 13.2 Vdc Input, 1.23, 2.5, 3.3, -12 Vdc/6, 1.5, 1.5, 2 A



Sep. 22, 2009

*Bel Power, Inc., a subsidiary of Bel Fuse, Inc.*

## Layout

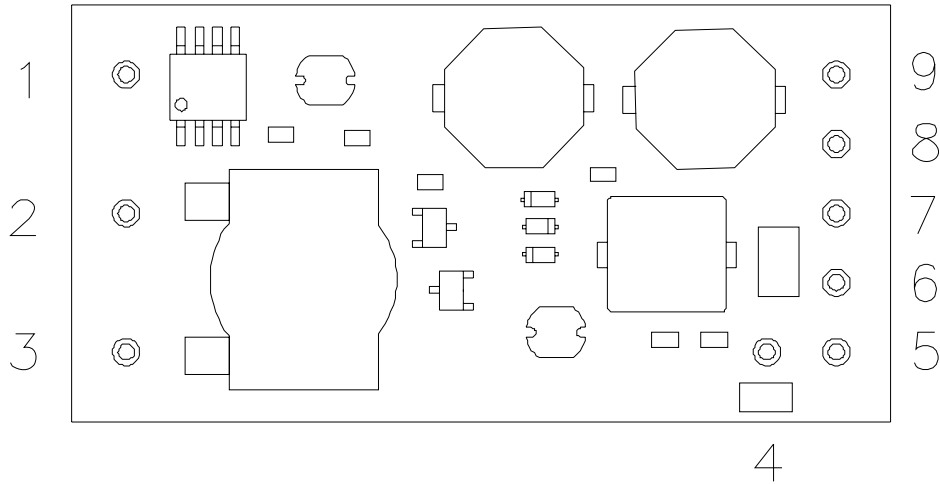

Layout of components on top side

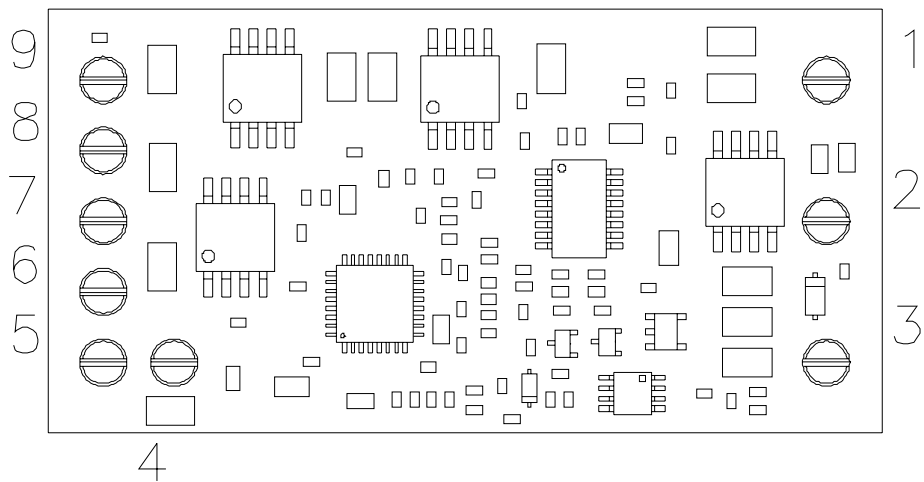

Layout of components on bottom side

# NON-ISOLATED DC/DC CONVERTERS

10.8 Vdc - 13.2 Vdc Input, 1.23, 2.5, 3.3, -12 Vdc/6, 1.5, 1.5, 2 A



Sep. 22, 2009

Bel Power, Inc., a subsidiary of Bel Fuse, Inc.

## Mechanical Outline

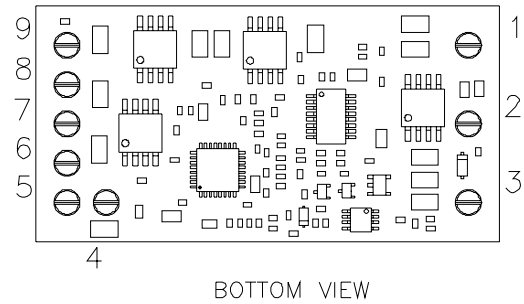
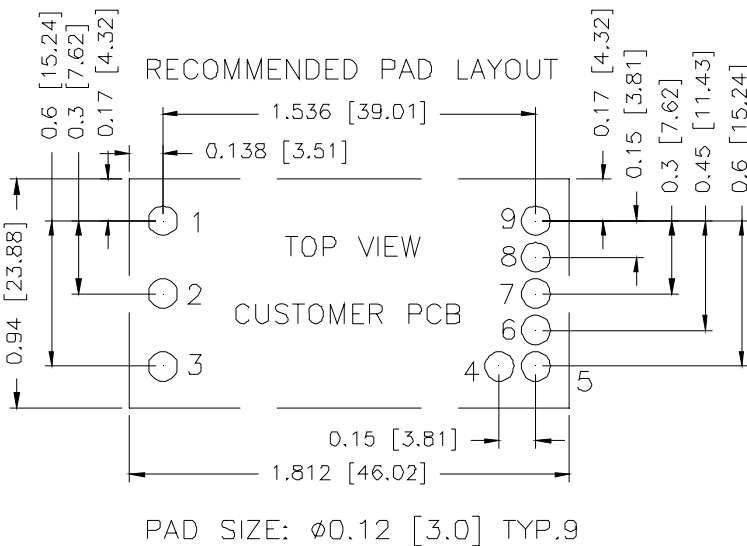
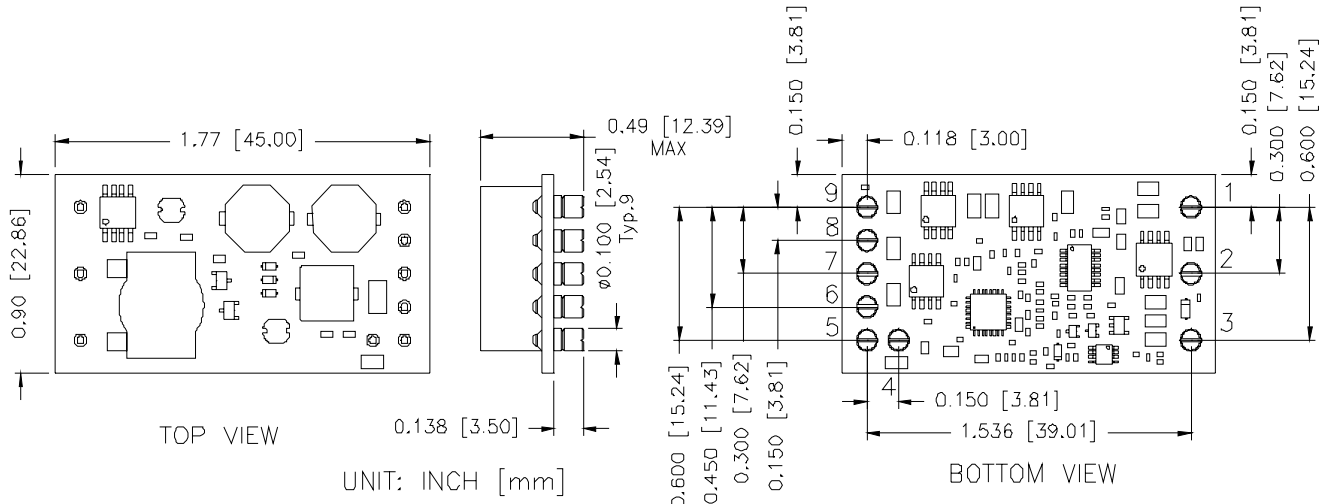

Pin	Function	Pin	Function
1	Vin	6	GND
2	ON/OFF	7	1.23Vout
3	GND	8	2.5Vout
4	-12Vout	9	3.3Vout
5	GND		

**Note:** This module is recommended and compatible with Pb-Free Reflow Soldering and must be soldered using a reflow profile with a peak temperature of no more than 260 °C for less than 5 seconds.

### Note:

- 1) All Pins: Material - Copper Alloy;  
Finish – 3 micro inches minimum Gold over 50 micro inches minimum Nickel plate.
- 2) Undimensioned components are shown for visual reference only.
- 3) All dimensions in inches (mm); Tolerances: x.xx +/-0.02 in. (x.x +/-0.5mm) x.xxx +/-0.010 in. (x.xx +/-0.25mm).

## NON-ISOLATED DC/DC CONVERTERS

10.8 Vdc - 13.2 Vdc Input, 1.23, 2.5, 3.3, -12 Vdc/6, 1.5, 1.5, 2 A



Sep. 22, 2009

*Bel Power, Inc. , a subsidiary of Bel Fuse, Inc.*

### Revision History

Date	Revision	Changes Detail	Approval
2009-04-16	A	First release	HL Lu
2009-07-20	B	1. Input specs: Update no load current and remote off current, ripple current (pk-pk), turn on/off voltage; 2. Output specs: Update load/line regulation, ripple and noise, transient response, turn on time, output cap, weight, add note for OCP; 3. Add efficiency curve, thermal derating, NR, TR, startup & shutdown; 4. Update remote on/off, UVLO, SEQ, MD	HL Lu
2009-09-22	C	1. Modify output voltage 2. Update efficiency data and MD 3. Add SCH and Layout	HL Lu

### RoHS Compliance

Complies with the European Directive 2002/95/EC, calling for the elimination of lead and other hazardous substances from electronic products.



©2009 Bel Fuse Inc. Specifications subject to change without notice. 092209

14

#### CORPORATE

**Bel Fuse Inc.**  
206 Van Vorst Street  
Jersey City, NJ 07302  
Tel 201-432-0463  
Fax 201-432-9542  
[www.belfuse.com](http://www.belfuse.com)

#### FAR EAST

**Bel Fuse Ltd.**  
8F/ 8 Luk Hop Street  
San Po Kong  
Kowloon, Hong Kong  
Tel 852-2328-5515  
Fax 852-2352-3706  
[www.belfuse.com](http://www.belfuse.com)

#### EUROPE

**Bel Fuse Europe Ltd.**  
Preston Technology Management Centre  
Marsh Lane, Suite G7, Preston  
Lancashire, PR1 8UD, U.K.  
Tel 44-1772-556601  
Fax 44-1772-888366  
[www.belfuse.com](http://www.belfuse.com)