

Xinger®

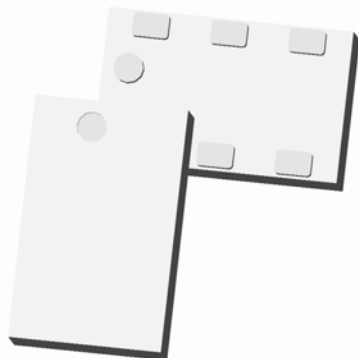

Ultra Low Profile 0805 3 dB, 90° Hybrid Coupler

Description

The C0810J5003A00 is a low cost, low profile sub-miniature high performance 3 dB coupler in an easy to use surface mount package. It is designed for 800 – 1000MHz applications including: GSM, WCDMA, CDMA and 900MHz ISM applications. The C0810J5003A00 is ideal for balanced power and low noise amplifiers, plus signal distribution and other applications where low insertion loss and tight amplitude and phase balance are required. The C0810J5003A00 is available on tape and reel for pick and place high volume manufacturing.

All of the Xinger components are constructed from ceramic filled PTFE composites which possess excellent electrical and mechanical stability having X and Y thermal coefficient of expansion (CTE) of 17 ppm/°C.

Detailed Electrical Specifications: Specifications subject to change without notice.

Features:	Parameter	ROOM (25°C)			Unit	
		Min.	Typ.	Max		
<ul style="list-style-type: none"> • 800 – 1000 MHz • 0.7mm Height Profile • GSM, WCDMA & 900 MHz ISM • Low Insertion Loss • High Isolation • Surface Mountable • Tape & Reel • Non-conductive Surface • RoHS Compliant 	Frequency	800		1000	MHz	
	Port Impedance		50		Ω	
	Return Loss	21	31		dB	
	Isolation	18	23		dB	
	Insertion Loss*		0.5	0.6	dB	
	Amplitude Balance		0.6	0.9	dB	
	Phase Balance (relative to 90°)		4	7	Degrees	
	Power Handling			4.0	Watts	
	Operating Temperature		-55		+85	°C

* Insertion Loss stated at room temperature (Insertion Loss is approximately 0.1 dB higher at +85 °C)

Outline Drawing

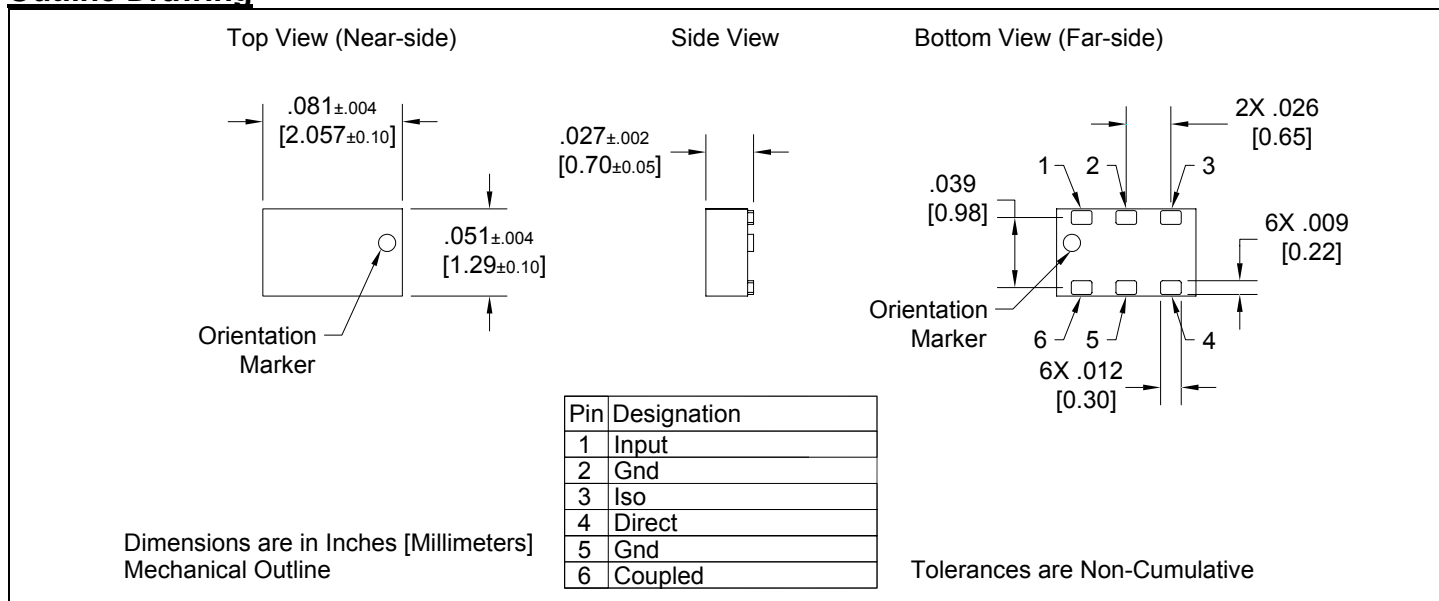

Typical Broadband Performance: 500 MHz. to 8000 MHz.

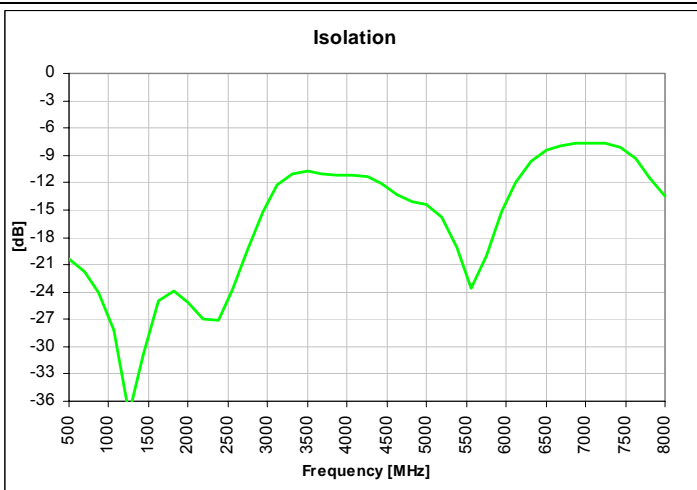
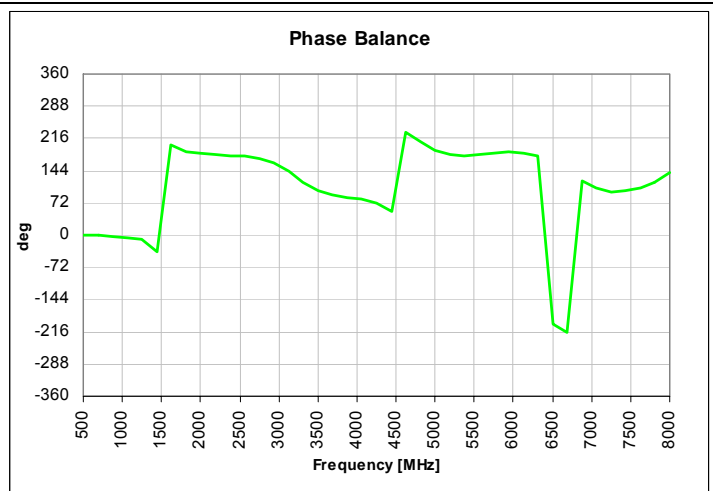
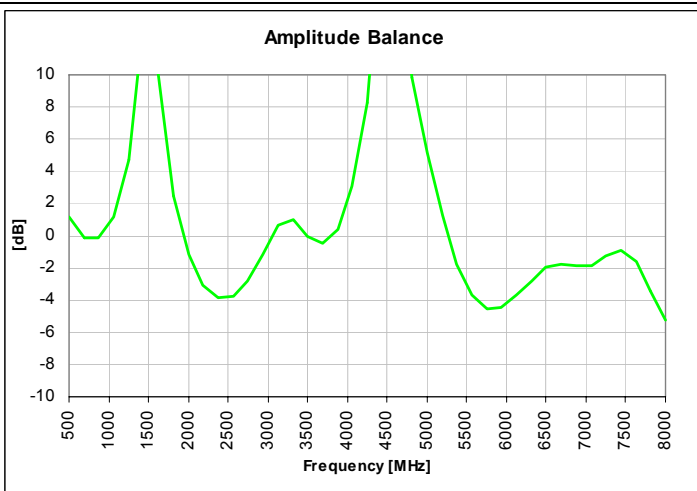
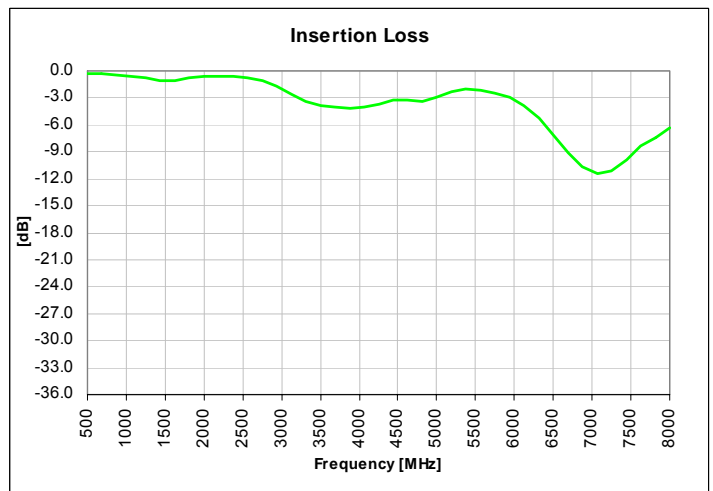
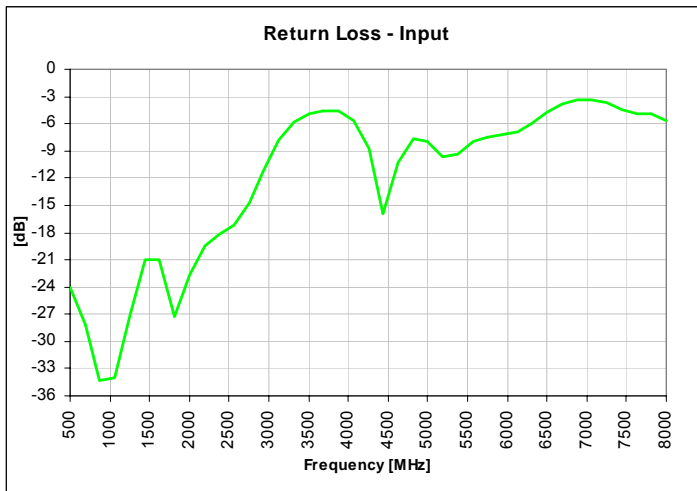

USA/Canada: (315) 432-8909
 Toll Free: (800) 411-6596
 Europe: +44 2392-232392

Available on Tape and Reel for Pick and Place Manufacturing.



Anaren

What'll we think of next?™

Typical Performance: 700 MHz. to 1100 MHz.

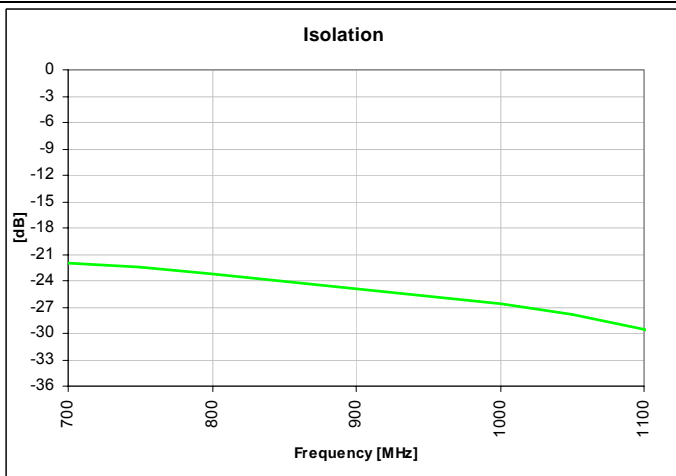
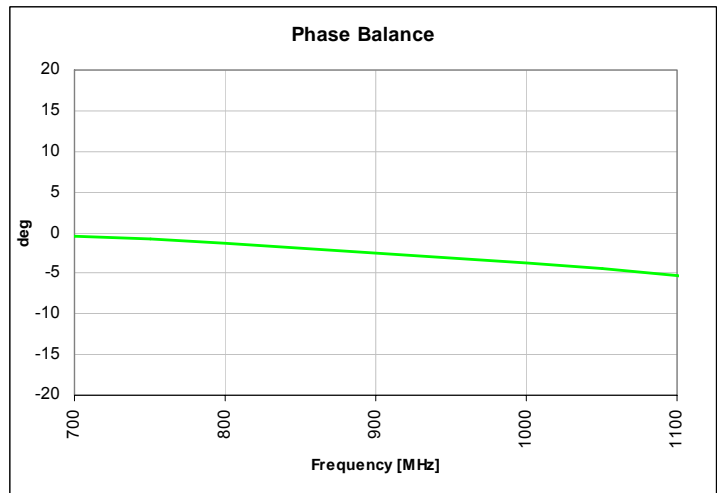
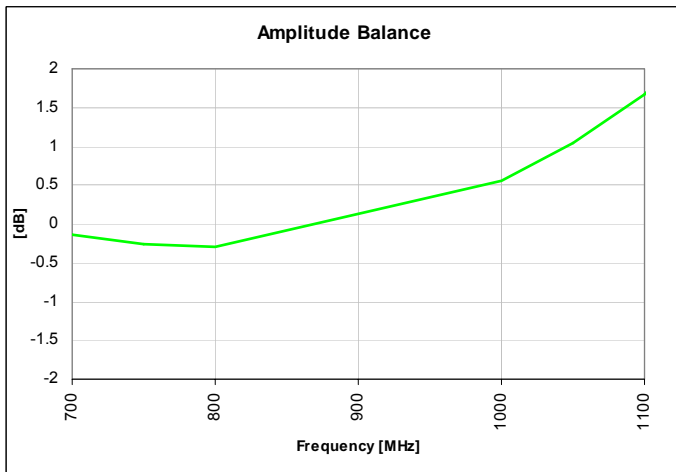
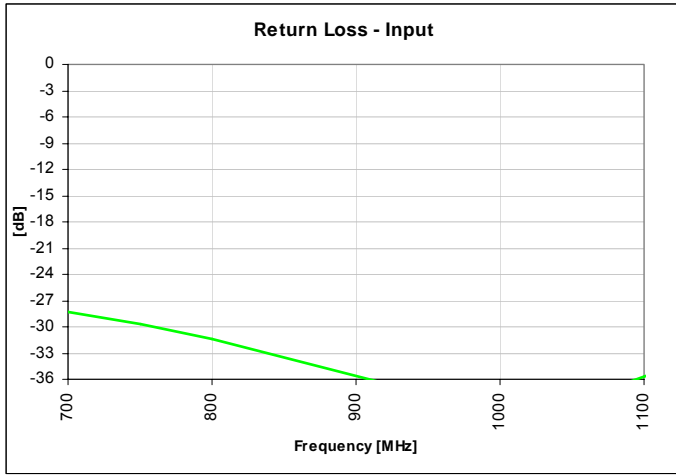

Mounting Configuration:

In order for Xinger surface mount components to work optimally, the proper impedance transmission lines must be used to connect to the RF ports. If this condition is not satisfied, insertion loss, Isolation and VSWR may not meet published specifications.

All of the Xinger components are constructed from ceramic filled PTFE composites which possess excellent electrical and mechanical stability having X and Y thermal coefficient of expansion (CTE) of 17 ppm/°C.

An example of the PCB footprint used in the testing of these parts is shown below. In specific designs, the transmission line widths need to be adjusted to the unique dielectric coefficients and thicknesses as well as varying pick and place equipment tolerances.

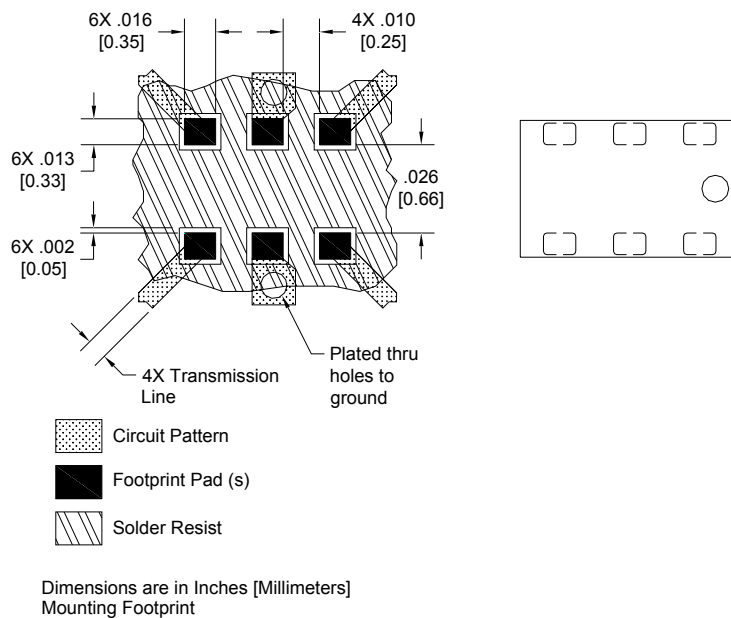

Packaging and Ordering Information

Parts are available in reel and are packaged per EIA 481-2. Parts are oriented in tape and reel as shown below. Minimum order quantities are 4000 per reel. See Model Numbers below for further ordering information.

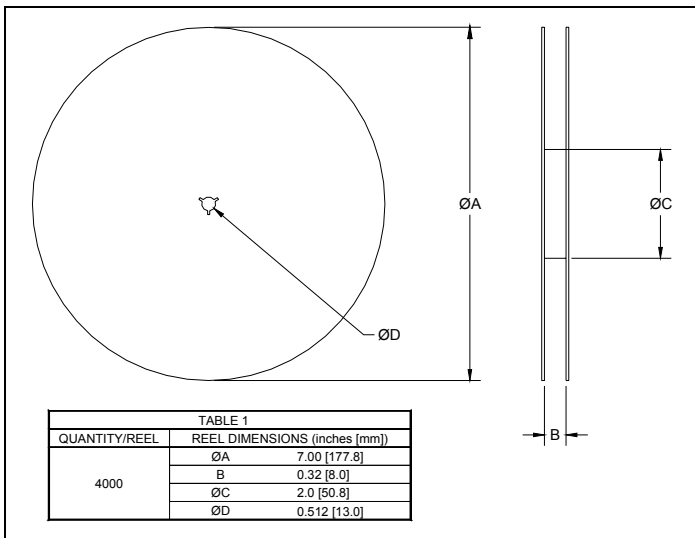
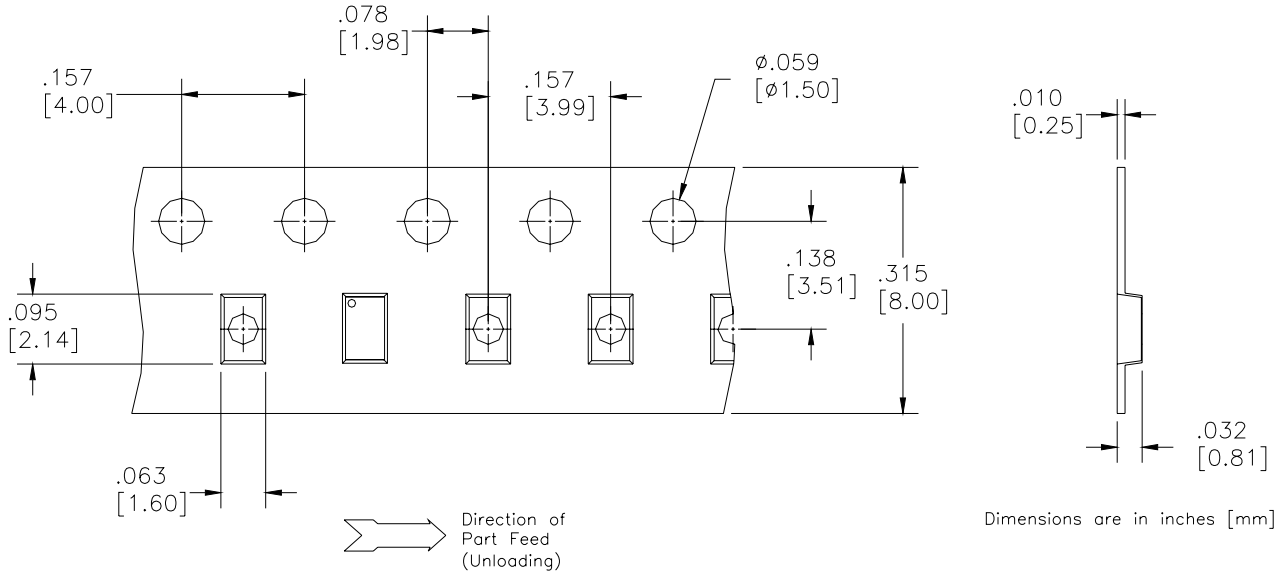

BD 2425 J 50 100 A 00

Function	Frequency	Package Dimensions	Unbalanced Impedance	Balanced Impedance + Coupling	Plating Finish	Codes
B = Balun	0110 = 100 – 1000 MHz	A = 150 x 150 mils (4mm x 4mm)	50 = 50 Ohm	25 = 25 Ω Balanced	A = Gold	
BD = Balun + DC	0810 = 800 – 1000 MHz	C = 120 x 120 mils (3mm x 3mm)	75 = 75 Ohm	30 = 30 Ω Balanced	P = Tin-Lead	
F = Filter	0922 = 950 – 2150 MHz	E = 100 x 80 mils (2.5mm x 2mm)		50 = 50 Ω Balanced		
FB = Filter / Balun	0826 = 800 – 2600 MHz	J = 80 x 50 mils (2mm x 1.25mm)		75 = 75 Ω Balanced		
C = 3dB Coupler	1222 = 1200 – 2200 MHz	L = 60 x 30 mils (1.5mm x 0.75mm)		100 = 100 Ω Balanced		
DC = Directional	1416 = 1400 – 1600 MHz	N = 40 x 40 mils (1mm x 1mm)		150 = 150 Ω Balanced		
J = RF Jumper	1722 = 1700 – 2200 MHz			200 = 200 Ω Balanced		
X = RF cross over	2326 = 2300 – 2600 MHz			300 = 300 Ω Balanced		
	2425 = 2400 – 2500 MHz			400 = 400 Ω Balanced		
	3150 = 3100 – 5000 MHz			03 = 3dB Hybrid		
	3436 = 3400 – 3600 MHz			10 = 10dB Directional		
	4859 = 4800 – 5900MHz			20 = 20dB Directional		
	5153 = 5100 – 5300 MHz					
	5159 = 5100 – 5900 MHz					
	5759 = 5700 – 5900 MHz					

USA/Canada: (315) 432-8909
 Toll Free: (800) 411-6596
 Europe: +44 2392-232392

Available on Tape and Reel for Pick and Place Manufacturing.



Anaren

What'll we think of next?™