

ELM75xxxxB CMOS Small package voltage detector

■ General description

ELM75xxxxB is CMOS voltage detector with lower current consumption (Typ. 0.6μA (Vdd=4.5V)) and higher accuracy (±2.0%) of detection voltage. It consists of very low-power-consumption reference voltage source, hysteresis comparator, output driver and detection voltage setting resistor. The output is positive logic; therefore, the output becomes low level when Vdd is lower than detection voltage. There are two output styles of ELM75 series: N-ch opendrain and CMOS output. The standard voltages are 2.2V, 2.7V, and 3.5V; ELM75 series can also be made as semi-custom IC within the range of 1.4V~5.5V by 0.1V step.

■ Features

- Detection voltage range : 1.4V~5.5V (by 0.1V)
- Low current consumption : Typ. 0.6μA (Vdd=4.5V)
- Low voltage operation : Reset operation assured at 0.8V
- Accuracy of detection voltage : ±2.0%
- Low temperature coefficient : Typ. +100ppm/°C
- Package : SOT-89, SOT-23, SC-82AB
SC-70(SOT-323)

■ Application

- Reset for microcomputers
- Voltage power shortage detectors
- Switch of back-up power source
- Battery checkers

■ Maximum absolute ratings

Parameter	Symbol	Limit	Unit
Power supply voltage	Vdd	10	V
Output voltage	Vout	N-ch : Vss-0.3~+10 CMOS: Vss-0.3~Vdd+0.3	V
Output current	Iout	20	mA
Power dissipation	Pd	300 (SOT-89) 200 (SOT-23) 150 (SC-82AB) 150 (SC-70)(SOT-323)	mW
Operating temperature	Top	-40~+85	°C
Storage temperature	Tstg	-55~+125	°C

■ Selection guide

ELM75xxxxB-x

Symbol		
a,b	Detection voltage	e.g. : 22: Vdetn=2.2V 23: Vdetn=2.3V 27: Vdetn=2.7V 35: Vdetn=3.5V
c	Output form	N : N-ch opendrain C : CMOS
d	Package	A : SOT-89 B : SOT-23 C : SC-82AB D : SOT-89(Reverse pin assign) E : SC-70(SOT-323)
e	Product version	B
f	Taping direction	S : Refer to PKG file N : Refer to PKG file

ELM75 x x x x B - x
 ↑ ↑ ↑ ↑ ↑ ↑
 a b c d e f

ELM75xxxxB CMOS Small package voltage detector

Pin configuration

SOT-89 (TOP VIEW)

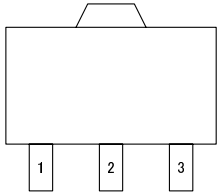

Pin No.	Pin name 75xxxAB	Pin name 75xxxDB
1	OUT	VDD
2	VDD	VSS
3	VSS	OUT

www.DataSheet4U.com
SOT-23 (TOP VIEW)

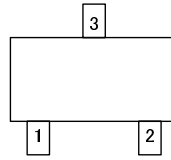

Pin No.	Pin name
1	OUT
2	VSS
3	VDD

SC-82AB (TOP VIEW)

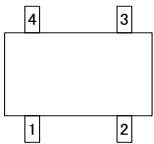

Pin No.	Pin name
1	OUT
2	VDD
3	NC
4	VSS

SC-70 (TOP VIEW)

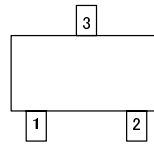

Pin No.	Pin name
1	OUT
2	VSS
3	VDD

Standard circuit

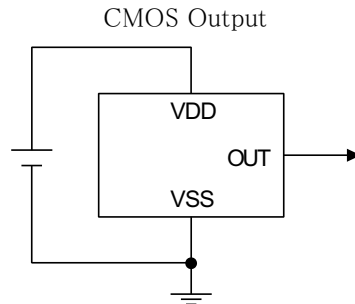
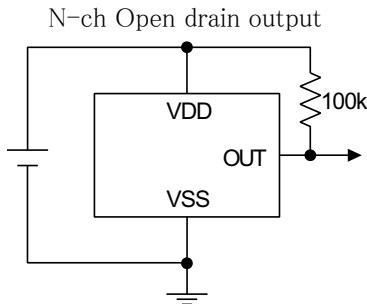

Block diagram

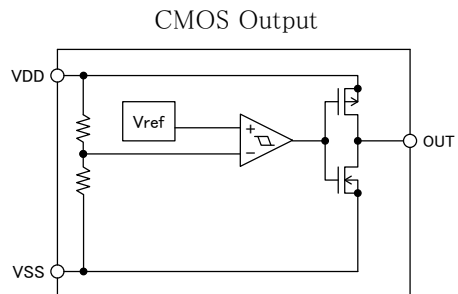
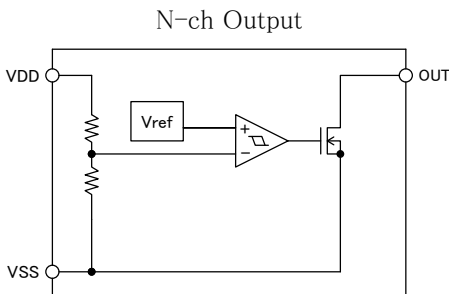

■ Timing chart

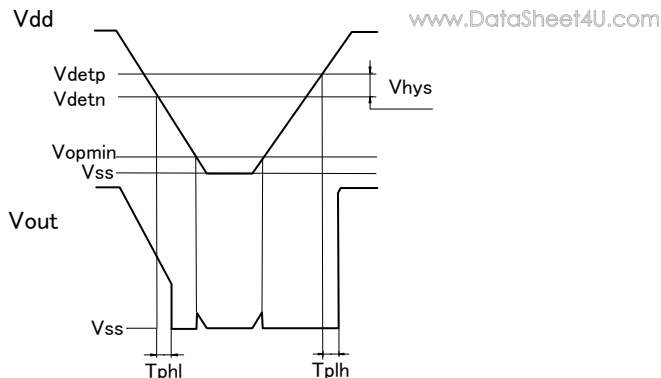

■ Electrical characteristics

Vdetn=2.2V (ELM7522xxB)

Top=25°C

Parameter	Symbol	Condition	Min.	Typ.	Max.	Unit	Note
Detection voltage	Vdetn		2.156	2.200	2.244	V	2
Hysteresis width	Vhys		Vdetn × 0.02	Vdetn × 0.04	Vdetn × 0.08	V	2
Current consumption	I _{ss}	Vdd=3.0V		0.6	2.0	μA	1
Power voltage	Vdd		0.8		6.0	V	2
Output current	I _{outn}	Vdd=0.95V, Vds=0.4V	0.03	0.12		mA	3-(1)
		Vdd=1.40V, Vds=0.4V	0.60	1.40			3-(2)
	I _{outp}	Vdd=3.00V, Vds=0.4V	0.15	0.40			
Delay time	T _{plh}	Vdd=0.95V~3.00V		10		μs	4
	T _{phl}	Vdd=3.00V~0.95V		10			
Temperature characteristic of Vdetn	$\frac{\Delta V_{detn}}{\Delta T_{op}}$	Top=-40~+85°C		+100		ppm/°C	

* Ioutp cannot be applied to N-ch opendrain output products. * Note : test circuit No.

Vdetn=2.3V (ELM7523xxB)

Top=25°C

Parameter	Symbol	Condition	Min.	Typ.	Max.	Unit	Note
Detection voltage	Vdetn		2.254	2.300	2.346	V	2
Hysteresis width	Vhys		Vdetn × 0.02	Vdetn × 0.04	Vdetn × 0.08	V	2
Current consumption	I _{ss}	Vdd=3.0V		0.6	2.0	μA	1
Power voltage	Vdd		0.8		6.0	V	2
Output current	I _{outn}	Vdd=0.95V, Vds=0.4V	0.03	0.12		mA	3-(1)
		Vdd=1.40V, Vds=0.4V	0.60	1.40			3-(2)
	I _{outp}	Vdd=3.00V, Vds=0.4V	0.15	0.40			
Delay time	T _{plh}	Vdd=0.95V~3.00V		10		μs	4
	T _{phl}	Vdd=3.00V~0.95V		10			
Temperature characteristic of Vdetn	$\frac{\Delta V_{detn}}{\Delta T_{op}}$	Top=-40~+85°C		+100		ppm/°C	

* Ioutp cannot be applied to N-ch opendrain output products. * Note : test circuit No.

ELM75xxxxB CMOS Small package voltage detector

Vdetn=2.4V (ELM7524xxB)

Top=25°C

Parameter	Symbol	Condition	Min.	Typ.	Max.	Unit	Note
Detection voltage	Vdetn		2.352	2.400	2.448	V	2
Hysteresis width	Vhys		Vdetn ×0.02	Vdetn ×0.04	Vdetn ×0.08	V	2
Current consumption	I _{ss}	V _{dd} =3.0V		0.6	2.0	μA	1
Power voltage	V _{dd}		0.8		6.0	V	2
Output current	I _{outn}	V _{dd} =0.95V, V _{ds} =0.4V	0.03	0.12		mA	3-(1)
		V _{dd} =1.40V, V _{ds} =0.4V	0.60	1.40			
	I _{outp}	V _{dd} =3.00V, V _{ds} =0.4V	0.15	0.40			3-(2)
Delay time	T _{plh}	V _{dd} =0.95V~3.00V		10		μs	4
	T _{phl}	V _{dd} =3.00V~0.95V		10			
Temperature characteristic of Vdetn	$\frac{\Delta V_{detn}}{\Delta Top}$	Top=-40~+85°C		+100		ppm/°C	

* I_{outp} cannot be applied to N-ch opendrain output products. * Note : test circuit No.

Vdetn=2.7V (ELM7527xxB)

Top=25°C

Parameter	Symbol	Condition	Min.	Typ.	Max.	Unit	Note
Detection voltage	Vdetn		2.646	2.700	2.754	V	2
Hysteresis width	Vhys		Vdetn ×0.02	Vdetn ×0.04	Vdetn ×0.08	V	2
Current consumption	I _{ss}	V _{dd} =4.5V		0.6	2.0	μA	1
Power voltage	V _{dd}		0.8		6.0	V	2
Output current	I _{outn}	V _{dd} =0.95V, V _{ds} =0.4V	0.03	0.12		mA	3-(1)
		V _{dd} =1.40V, V _{ds} =0.4V	0.60	1.40			
	I _{outp}	V _{dd} =4.50V, V _{ds} =0.4V	0.20	0.60			3-(2)
Delay time	T _{plh}	V _{dd} =0.95V~4.50V		10		μs	4
	T _{phl}	V _{dd} =4.50V~0.95V		10			
Temperature characteristic of Vdetn	$\frac{\Delta V_{detn}}{\Delta Top}$	Top=-40~+85°C		+100		ppm/°C	

* I_{outp} cannot be applied to N-ch opendrain output products. * Note : test circuit No.

Vdetn=3.0V (ELM7530xxB)

Top=25°C

Parameter	Symbol	Condition	Min.	Typ.	Max.	Unit	Note
Detection voltage	Vdetn		2.940	3.000	3.060	V	2
Hysteresis width	Vhys		Vdetn ×0.02	Vdetn ×0.04	Vdetn ×0.08	V	2
Current consumption	I _{ss}	V _{dd} =4.5V		0.6	2.0	μA	1
Power voltage	V _{dd}		0.8		6.0	V	2
Output current	I _{outn}	V _{dd} =0.95V, V _{ds} =0.4V	0.03	0.12		mA	3-(1)
		V _{dd} =1.40V, V _{ds} =0.4V	0.60	1.40			
	I _{outp}	V _{dd} =4.50V, V _{ds} =0.4V	0.20	0.60			3-(2)
Delay time	T _{plh}	V _{dd} =0.95V~4.50V		10		μs	4
	T _{phl}	V _{dd} =4.50V~0.95V		10			
Temperature characteristic of Vdetn	$\frac{\Delta V_{detn}}{\Delta Top}$	Top=-40~+85°C		+100		ppm/°C	

* I_{outp} cannot be applied to N-ch opendrain output products. * Note : test circuit No.

ELM75xxxxB CMOS Small package voltage detector

Vdetn=3.5V (ELM7535xxB)

Top=25°C

Parameter	Symbol	Condition	Min.	Typ.	Max.	Unit	Note
Detection voltage	Vdetn		3.430	3.500	3.570	V	2
Hysteresis width	Vhys		Vdetn ×0.02	Vdetn ×0.04	Vdetn ×0.08	V	2
Current consumption	I _{ss}	V _{dd} =4.5V		0.6	2.0	μA	1
Power voltage	V _{dd}		0.8		6.0	V	2
Output current	I _{outn}	V _{dd} =0.95V, V _{ds} =0.4V	0.03	0.12		mA	3-(1)
		V _{dd} =1.40V, V _{ds} =0.4V	0.60	1.40			
	I _{outp}	V _{dd} =4.50V, V _{ds} =0.4V	0.20	0.60			3-(2)
Delay time	T _{plh}	V _{dd} =0.95V~4.50V		10		μs	4
	T _{phl}	V _{dd} =4.50V~0.95V		10			
Temperature characteristic of Vdetn	$\frac{\Delta V_{detn}}{\Delta Top}$	Top=-40~+85°C		+100		ppm/°C	

* I_{outp} cannot be applied to N-ch opendrain output products. * Note : test circuit No.

Vdetn=4.0V (ELM7540xxB)

Top=25°C

Parameter	Symbol	Condition	Min.	Typ.	Max.	Unit	Note
Detection voltage	Vdetn		3.920	4.000	4.080	V	2
Hysteresis width	Vhys		Vdetn ×0.02	Vdetn ×0.04	Vdetn ×0.08	V	2
Current consumption	I _{ss}	V _{dd} =4.5V		0.6	2.0	μA	1
Power voltage	V _{dd}		0.8		6.0	V	2
Output current	I _{outn}	V _{dd} =0.95V, V _{ds} =0.4V	0.03	0.12		mA	3-(1)
		V _{dd} =1.40V, V _{ds} =0.4V	0.60	1.40			
	I _{outp}	V _{dd} =4.50V, V _{ds} =0.4V	0.20	0.60			3-(2)
Delay time	T _{plh}	V _{dd} =0.95V~4.50V		10		μs	4
	T _{phl}	V _{dd} =4.50V~0.95V		10			
Temperature characteristic of Vdetn	$\frac{\Delta V_{detn}}{\Delta Top}$	Top=-40~+85°C		+100		ppm/°C	

* I_{outp} cannot be applied to N-ch opendrain output products. * Note : test circuit No.

Test circuits

1) Current consumption

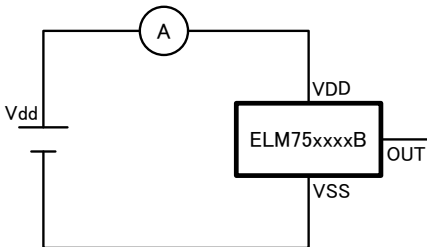

2) Detection voltage

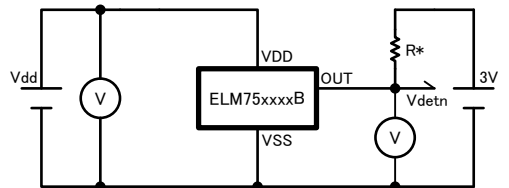

* Pull up circuit is necessary for N-ch output only.
* R=100KΩ (R=2MΩ for V_{dd} min measurement.)

ELM75xxxxB CMOS Small package voltage detector

3)-(1) Output current (N-ch)

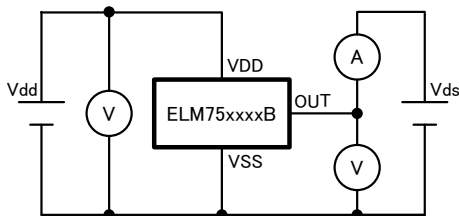

3)-(2) Output current (P-ch)

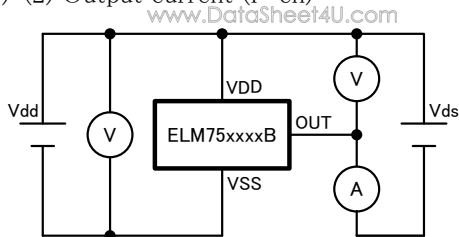

4) Delay time

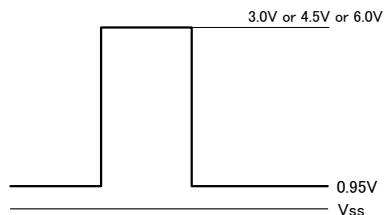
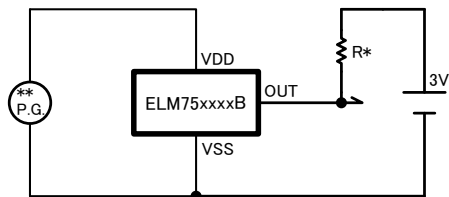

- * Pull up circuit is necessary for N-ch output only.
- * R=100K Ω

** Input pulse

■ Marking

SC-82AB

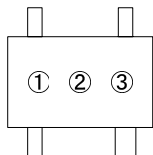

SC-70

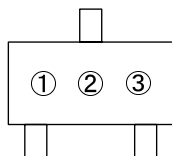

• SC-82AB package • SC-70 package

No. ① : Detection voltage

Mark	Vdetn	Mark	Vdetn	Mark	Vdetn
Y	1.4V	G	2.8V	5	4.2V
Z	1.5V	H	2.9V	6	4.3V
1	1.6V	J	3.0V	=	4.4V
2	1.7V	K	3.1V	7	4.5V
3	1.8V	L	3.2V	*	4.6V
4	1.9V	M	3.3V	+	4.7V
V	2.0V	N	3.4V	-	4.8V
W	2.1V	P	3.5V	>	4.9V
A	2.2V	Q	3.6V	8	5.0V
B	2.3V	R	3.7V	9	5.1V
C	2.4V	S	3.8V	0	5.2V
D	2.5V	T	3.9V	<	5.3V
E	2.6V	U	4.0V	/	5.4V
F	2.7V	#	4.1V	X	5.5V

No. ② : Assembly lot No.

A~Z (I, O, X excepted) : N-ch
0~9 : CMOS

No. ③ : Assembly lot No.

0~9 : N-ch
A~Z (I, O, X excepted) : CMOS

• SOT-89 package

www.DataSheet4U.com

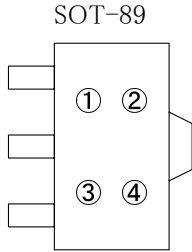

No. ① : the integer digit of detection voltage

Mark	Vdetn	Mark	Vdetn
9	1.*V	8	4.*V
6	2.*V	X	5.*V
7	3.*V		

No. ② : the decimal digit of detection voltage

Mark	Vdetn	Mark	Vdetn
0	*.0V	5	*.5V
1	*.1V	6	*.6V
2	*.2V	7	*.7V
3	*.3V	8	*.8V
4	*.4V	9	*.9V

No. ③ : Assembly lot No.

A~Z (I, O, X excepted) : N-ch
0~9 : CMOS

No. ④ : Assembly lot No.

0~9 : N-ch
A~Z (I, O, X excepted) : CMOS

• SOT-23 package

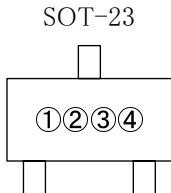

No. ① : the integer digit of detection voltage

Mark	Vdetn	Mark	Vdetn
0	1.*V	9	4.*V
7	2.*V	X	5.*V
8	3.*V		

No. ② : the decimal digit of detection voltage

Mark	Vdetn	Mark	Vdetn
0	*.0V	5	*.5V
1	*.1V	6	*.6V
2	*.2V	7	*.7V
3	*.3V	8	*.8V
4	*.4V	9	*.9V

No. ③ : Assembly lot No.

A~Z (I, O, X excepted) : N-ch
0~9 : CMOS

No. ④ : Assembly lot No.

0~9 : N-ch
A~Z (I, O, X excepted) : CMOS

Current consumption characteristics

www.DataSheet4U.com

• ELM7522xxB

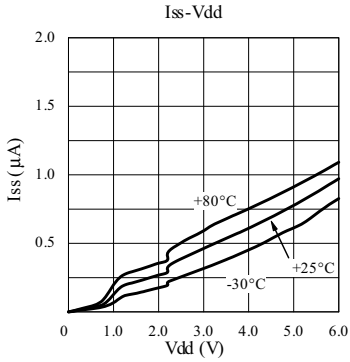

• ELM7524xxB

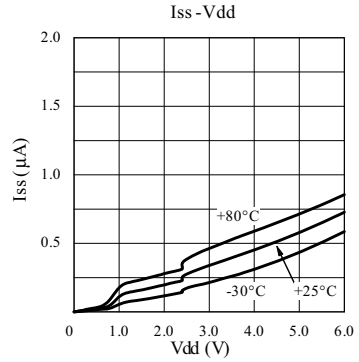

• ELM7527xxB

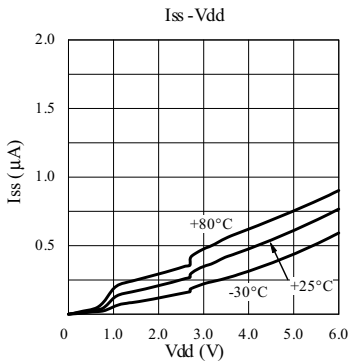

• ELM7530xxB

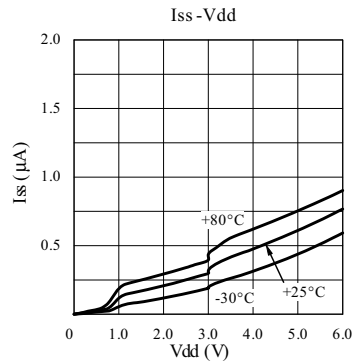

• ELM7535xxB

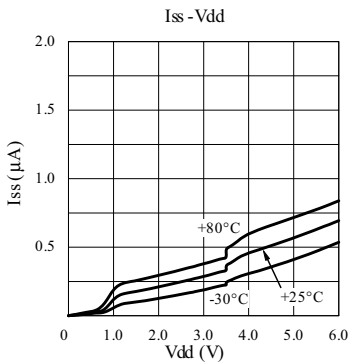

• ELM7540xxB

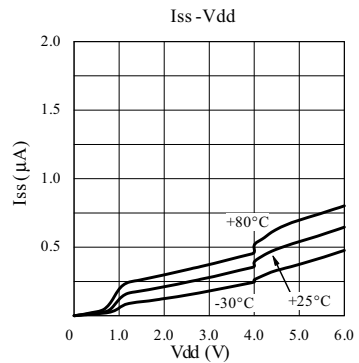

■ Detection voltage characteristics

www.DataSheet4U.com

• ELM7522xxB

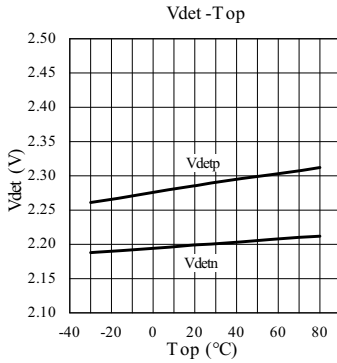

• ELM7524xxB

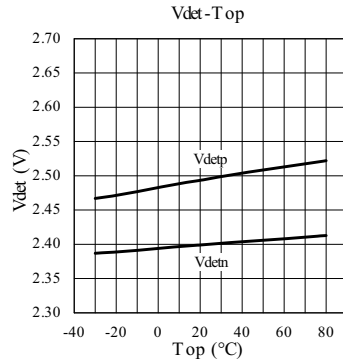

• ELM7527xxB

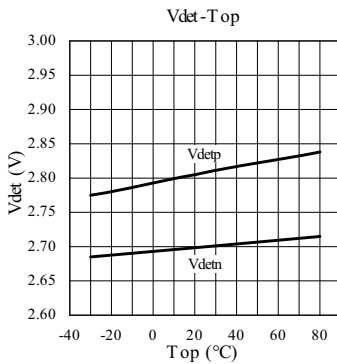

• ELM7530xxB

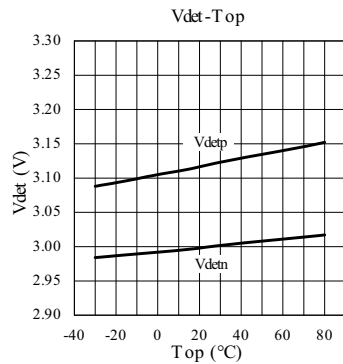

• ELM7535xxB

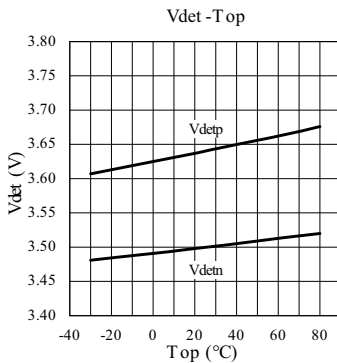

• ELM7540xxB

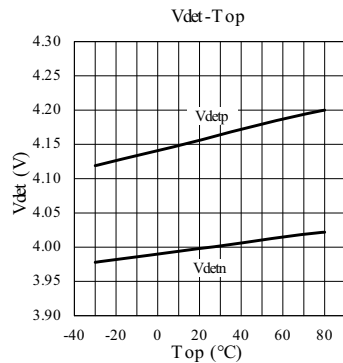

Output voltage characteristics

www.DataSheet4U.com

• ELM7522NxB

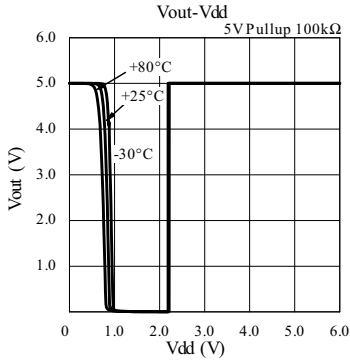

• ELM7524NxB

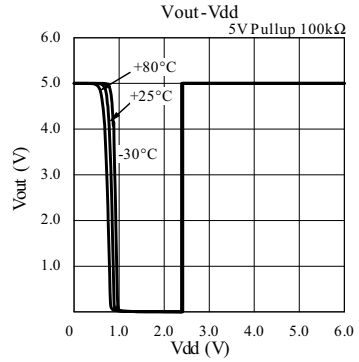

• ELM7527NxB

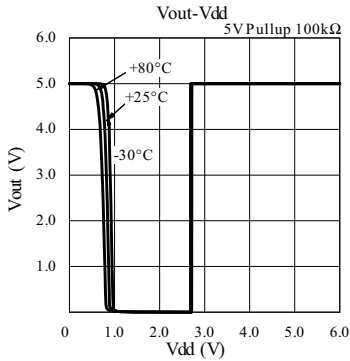

• ELM7530NxB

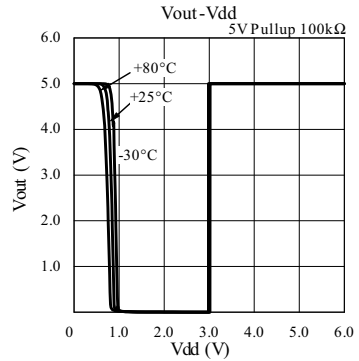

• ELM7535NxB

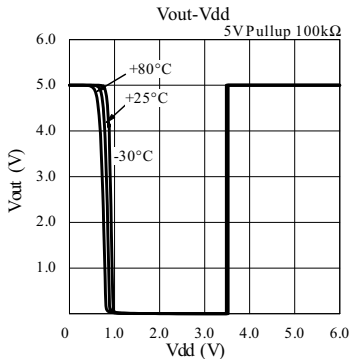

• ELM7540NxB

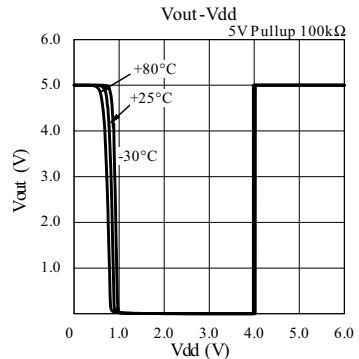

Output current characteristics

www.DataSheet4U.com

- ELM75xxxxB

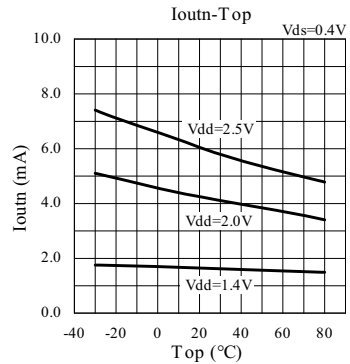
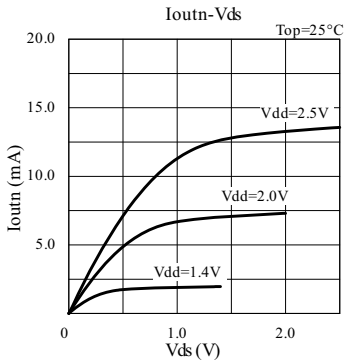
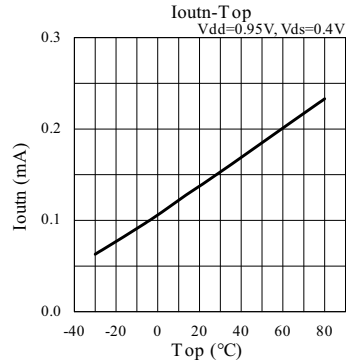
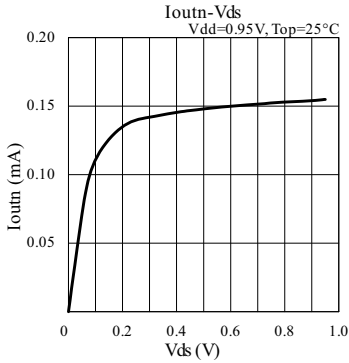

- ELM75xxCxB

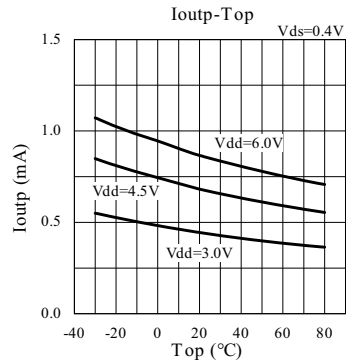
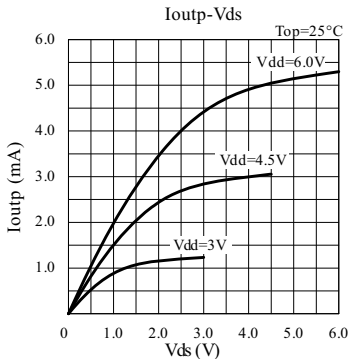

■ Delay time characteristics

www.DataSheet4U.com

- ELM7522xxB, ELM7524xxB

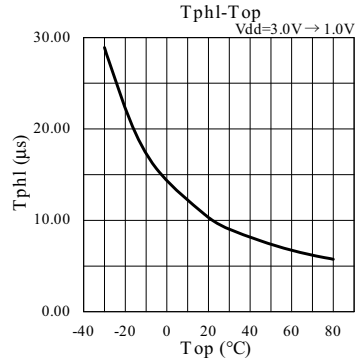
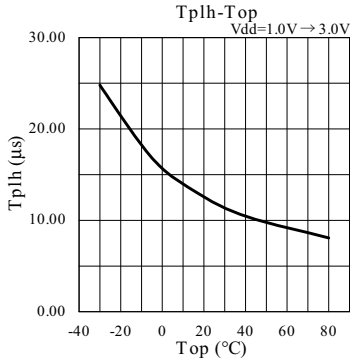

- ELM7527xxB, ELM7530xxB, ELM7535xxB, ELM7540xxB

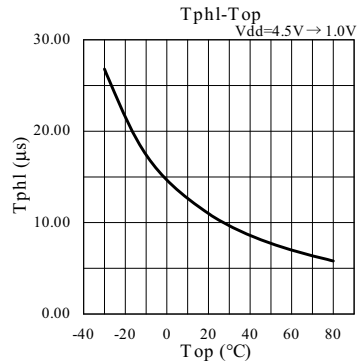
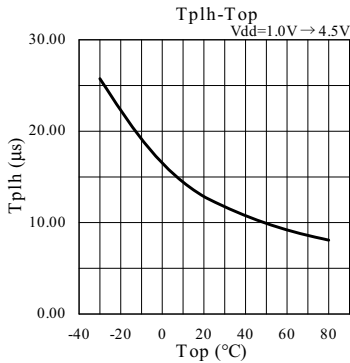

■ Hysteresis width characteristics

- ELM75xxxxB

