

EE-SPW321(-A)/421(-A)

Compact, Thin-profile
Photomicrosensor with Special
Amplifier

- Slim amplifier with NPN output for easy handling and mounting
- Operation indicator allows monitoring from the amplifier housing or sensor head
- Simple wiring with a 3-conductor cable
- Light modulation effectively reduces external light interference



Ordering Information

■ PHOTOMICROSENSORS

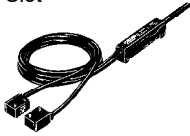
Sensing method	Sensing distance	Sensing object	Output configuration	Part number
	30 cm	Opaque: 2 mm dia. min.	Dark-ON	EE-SPW321
				EE-SPW321-A
			Light-ON	EE-SPW421
				EE-SPW421-A

■ SENSING DISTANCE WITH APERTURE*

Size of aperture	Sensing distance	Sensing object
0.5 x 3 mm	10 cm	Opaque: 0.5 mm dia. min.
1 x 3 mm	20 cm	Opaque: 1 mm dia. min.

*Four apertures comprised of 2 different widths are provided with sensor unit.

Specifications

■ RATINGS

Supply voltage	12 VDC -10% to 24 VDC +10%
Current consumption	30 mA max.
Sensing distance*	30 cm
Standard reference object**	Opaque: 2 mm dia. min.
Directional angle	10° to 40°
Response time	1 ms max. for both detection and reset
Control output	Load current: 100 mA (residual voltage: 1 V max.)
Light source	GaAs infrared LED (pulse modulated) with a peak wavelength of 940 nm
Operation indicator	Light-ON (red LEDs on sensor and amplifier)
Connecting method	Pre-wired with 2 m cable

*Refer to *Receiver Output vs. Sensing Distance Characteristics* in *Engineering Data*.

**An object as minute as 0.5 mm dia. can be sensed when an aperture is attached to the sensor.

CHARACTERISTICS

Ambient illumination		Sensing face: 3,000 lx max. (incandescent light); 10,000 lx max. (sunlight)
Enclosure ratings		IP64
Ambient temperature	Operating	-20°C to 55°C (-4°F to 131°F)
Ambient humidity	Operating	35% to 85%
Vibration resistance		Destruction: 10 to 55 Hz, 1.5-mm double amplitude for 2 hrs each in X, Y, and Z directions
Shock resistance		Destruction: 500 m/s ² (approx. 50G)
Material	Case	ABS resin
	Lens	Acrylate resin

Engineering Data

RECEIVER OUTPUT VS. SENSING DISTANCE

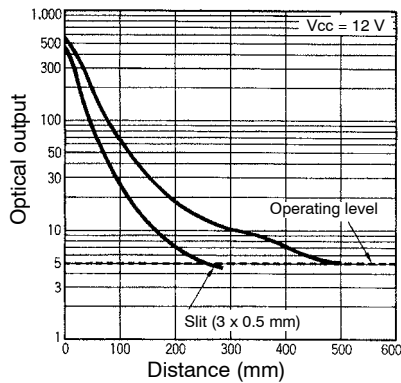

MUTUAL INTERFERENCE

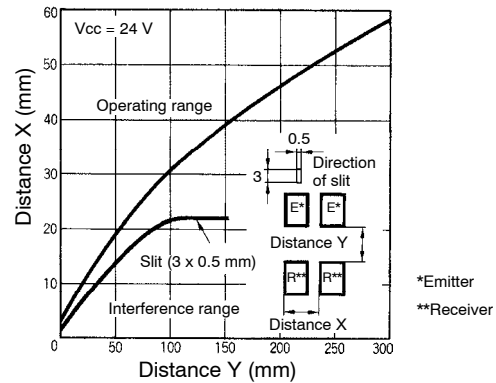

SENSING ANGLE CHARACTERISTICS

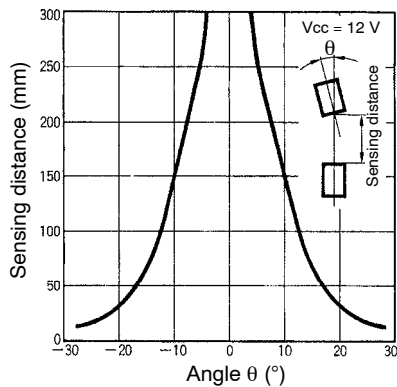

SENSING DISTANCE VS. INPUT VOLTAGE

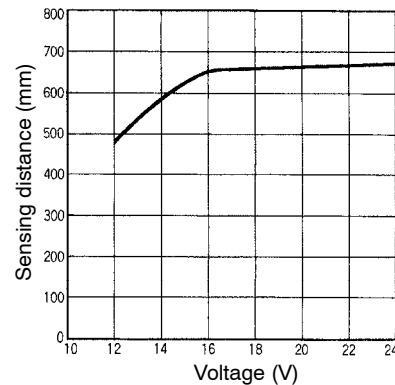

Operation

INTERNAL/EXTERNAL CIRCUIT DIAGRAM

Light-ON/Dark-ON

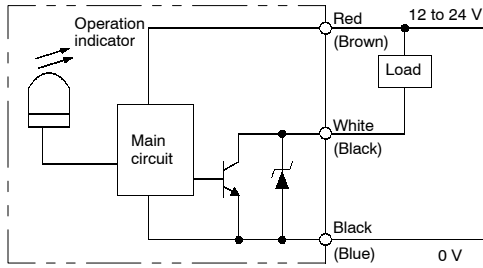

Note: IEC colors are shown in parentheses.

TIMING CHART

Light-ON

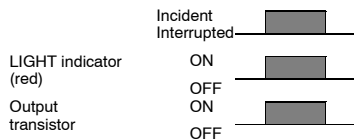

Dark-ON

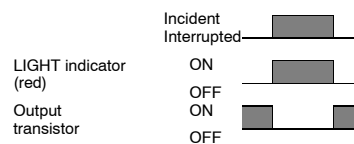

Dimensions

Unit: mm (inch)

EE-SPW321(-A)/SPW421(-A)

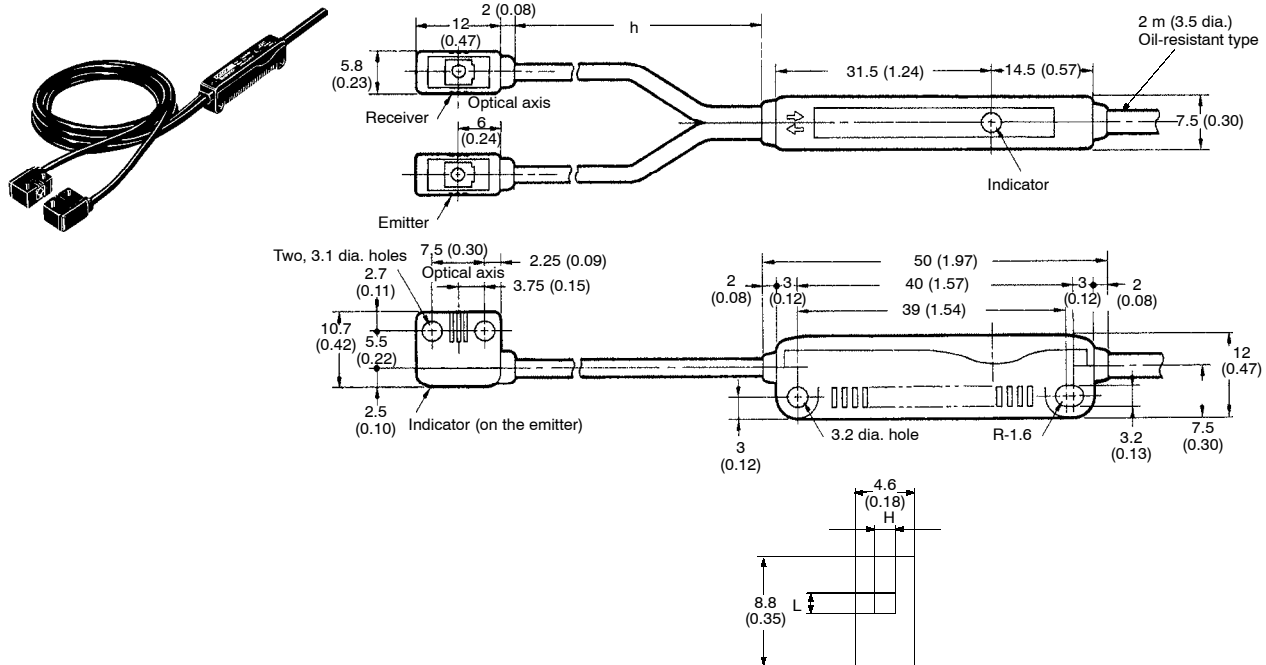

Sensing head to amplifier cable length

Model	h (mm)
EE-SPW321	500
EE-SPW321-A	1,000
EE-SPW421	500
EE-SPW421-A	1,000

Aperture Size

Aperture	Size L	Size H
Slit A	0.5 mm	3 mm
Slit B	1 mm	3 mm
Slit C	3 mm	0.5 mm
Slit D	3 mm	1 mm

Precautions

Refer to the Technical Information section for general precautions.

■ OPTICAL AXIS ADJUSTMENT

Move the light source head and the receiver vertically and horizontally to obtain a proper angular range in which the operation indicator turns ON. Then fix both of the heads securely.

■ MOUNTING

The main body and both heads must be fitted to a warping-free mount using the attached screws with a torque of 5.5 kg • cm or below.

■ APERTURES

Four kinds of reticles are included with the sensor as follows:

- (A) 0.5 mm by 3 mm, horizontal slit
- (B) 1 mm by 3 mm, horizontal slit
- (C) 3 mm by 0.5 mm, vertical slit
- (D) 3 mm by 1 mm, vertical slit

Use the reticles when the detected surface of object is smaller than 2 mm in width, or when mutual interference must be reduced. Select a pair of reticles the same size according to the above conditions.

Attach the selected reticles on the lens of the light source head and receiver head respectively.

■ CONNECTIONS

Routing the wire of the photomicrosensor in close proximity to high potential power lines may result in malfunction or damage because of inductive effects. Be sure to route the sensor wires separate from the power lines or through a separate conduit.

For extending the sensor wires, use a cable greater than AWG 22 in diameter and shorter than 100 m. As impedance of the extended cable increases, the supply voltage applied to the sensor terminal will decrease, and the low level output voltage at the cable end will increase. For this reason, consider the voltage fluctuation when extending the sensor cable.

■ POWER SOURCE

When using a commercially available switching regulator, be sure to ground the FG (Frame Ground) and G (Ground) terminals; otherwise, faulty operation of the sensor may be caused by the switching noise.

■ EFFECT OF ELECTRICAL NOISE

The sensor output may be affected by noise from switching regulators or the other instruments. In this case, place a 0.47 μF capacitor between the 0 V terminal and the frame.

■ MATERIALS OF SENSOR HOUSING

The main body and the heads are made of ABS resin. The lens sections of the both heads are made of acrylic resin. They may be dissolved by organic solvent and strong acidic substances.

Excessive forces (hitting by hammer, or the like) should not be applied to the product because they may damage its water-resistance ability.

■ WATER RESISTANCE

The photomicrosensor does not have a complete water-resistant construction. The water-resistant level of the product is IP64 (IEC529). Therefore, do not use or store it in water or in rainfall.

NOTE: DIMENSIONS SHOWN ARE IN MILLIMETERS. To convert millimeters to inches divide by 25.4.

OMRON[®]
OMRON ELECTRONICS LLC
 One East Commerce Drive
 Schaumburg, IL 60173
1-800-55-OMRON

OMRON ON-LINE
 Global - <http://www.omron.com>
 USA - <http://www.omron.com/oei>
 Canada - <http://www.omron.com/oci>

OMRON CANADA, INC.
 885 Milner Avenue
 Toronto, Ontario M1B 5V8
416-286-6465