

**5.0Gbps 4-Lane PCI Express Gen2 Re-Driver with Equalization & Emphasis**

**Features**

- Up to 5.0Gbps PCI Express Gen-2 Serial Re-driver
- Supporting 8 differential channels or 4 lanes of PCIe Interface
- Pin strapped and I<sup>2</sup>C configuration controls (3.3V Tolerant)
- Adjustable receiver equalization
- Adjustable transmitter amplitude and de-emphasis
- Variable input an output termination
- 1:2 channel broadcast
- Channel loop-back
- Electrical Idle fully supported
- Receiver detect and individual output control
- Single supply voltage, 1.2V ± 0.05V
- Power down modes
- Packaging: 100-contact LFBGA, Pb-free & Green

**Description**

Pericom Semiconductor’s PI2EQX5804 is a low power, PCI-express compliant signal re-driver. The device provides programmable equalization, amplification, and de-emphasis by using 8 select bits, to optimize performance over a variety of physical mediums by reducing Inter-symbol interference.

PI2EQX5804 supports eight 100-Ohm Differential CML data I/O’s between the Protocol ASIC to a switch fabric, across a backplane, or extends the signals across other distant data pathways on the user’s platform.

The integrated equalization circuitry provides flexibility with signal integrity of the PCI-express signal before the re-driver, whereas the integrated de-emphasis circuitry provides flexibility with signal integrity of the signal after the re-driver.

In addition to providing signal re-conditioning, Pericom’s PI2EQX5804 also provides power management Stand-by mode operated by a Power Down pin.

**Block Diagram**

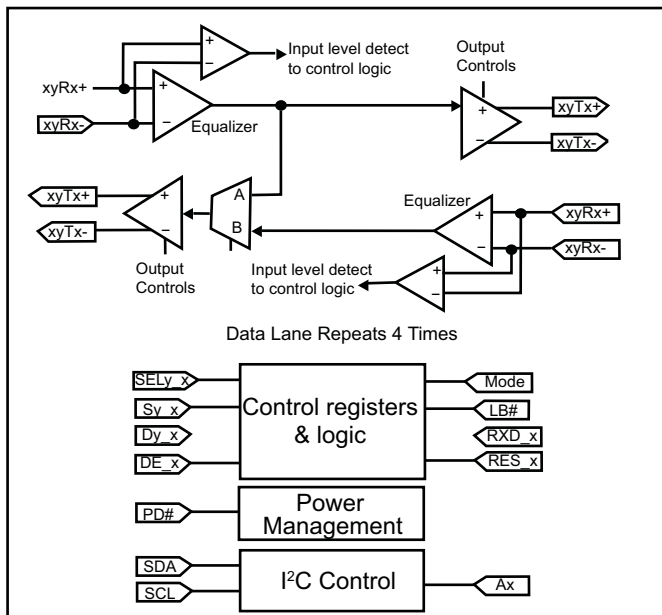

**Pin Configuration (Top-Side View)**

	1	2	3	4	5	6	7	8	9	10
A	VDD	B0TX- B0TX+	VDD	SCL	SDA	VDD	B0RX+ B0RX-	VDD		
B	A1RX+	GND	GND	A0RX-	DE_A	VDD	A0TX- GND	GND	A1TX+	
C	A1RX-	GND	GND	A0RX+	NC	PD#	A0TX+ GND	GND	A1TX-	
D	VDD	B1TX+ B1TX-	VDD	D2_A	NC	VDD	B1RX- B1RX+	VDD		
E	SEL0_A	SEL1_A	SEL2_A	D0_A	D1_A	S0_A	RXD_A	S1_A	SIG_A	RX50_A
F	RX50_B	SIG_B	S1_B	RXD_B	S0_B	A1	SEL2_B	LB#	SEL1_B	SEL0_B
G	VDD	A2RX- A2RX+	VDD	MODE	D0_B	VDD	A2TX+ A2TX-	VDD		
H	B2TX+	GND	GND	B3TX-	DE_B	A0	B3RX- GND	GND	B2RX+	
J	B2TX-	GND	GND	B3TX+	RESET#	D1_B	B3RX+ GND	GND	B2RX-	
K	VDD	A3RX+ A3RX-	VDD	D2_B	A4	VDD	A3TX- A3TX+	VDD		

Pin #	Pin Name	Type	Description
<b>Data Signals</b>			
C4 B4	A0RX+, A0RX-	I I	CML inputs for Channel A0, with internal 50-Ohm pull down during normal operation, and >200K-Ohm otherwise.
C7 B7	A0TX+, A0TX-	O O	CML outputs for Channel A0, with internal 50-Ohm pull up during normal operation and 2K-Ohm pull up otherwise.
B1 C1	A1RX+, A1RX-	I I	CML inputs for Channel A1, with internal 50-Ohm pull down during normal operation, and >200K-Ohm otherwise.
B10 C10	A1TX+, A1TX-	O O	CML outputs for Channel A1, with internal 50-Ohm pull up during normal operation and 2K-Ohm pull up otherwise.
G3 G2	A2RX+, A2RX-	I I	CML inputs for Channel A2, with internal 50-Ohm pull down during normal operation, and >200K-Ohm otherwise.
G8 G9	A2TX+, A2TX-	O O	CML outputs for Channel A2, with internal 50-Ohm pull up during normal operation and 2K-Ohm pull up otherwise.
K2 K3	A3RX+, A3RX-	I I	CML inputs for Channel A3 with internal 50-Ohm pull down during normal operation, and >200K-Ohm otherwise.
K9 K8	A3TX+, A3TX-	O O	CML outputs for Channel A3, with internal 50-Ohm pull up during normal operation and and 2K-Ohm pull up otherwise.
A8 A9	B0RX+, B0RX-	I I	CML inputs for Channel B0, with internal 50-Ohm pull down during normal operation, and >200K-Ohm otherwise.
A3 A2	B0TX+, B0TX-	O O	CML outputs for Channel B0, with internal 50-Ohm pull up during normal operation and 2K-Ohm pull up otherwise.
D9 D8	B1RX+, B1RX-	I I	CML inputs for Channel B1, with internal 50-Ohm pull down during normal operation, and >200K-Ohm otherwise.
D2 D3	B1TX+, B1TX-	O O	CML outputs for Channel B1, with internal 50-Ohm pull up during normal operation and 2K-Ohm pull up otherwise.
H10 J10	B2RX+, B2RX-	I I	CML inputs for Channel B2, with internal 50-Ohm pull down during normal operation, and >200K-Ohm otherwise.
H1 J1	B2TX+, B2TX-	O O	CML outputs for Channel B2, with internal 50-Ohm pull up during normal operation and 2K-Ohm pull up otherwise.
J7 H7	B3RX+, B3RX-	I I	CML inputs for Channel B3, with internal 50-Ohm pull down during normal operation, and >200K-Ohm otherwise.
J4 H4	B3TX+, B3TX-	O O	CML outputs for Channel B3, with internal 50-Ohm pull up during normal operation and 2K-Ohm pull up otherwise.
<b>Control Signals</b>			
H6, F6, K6	A0, A1, A4	I	I2C programmable address bit A0, A1 and A4.
E4, E5, D5	D[0:2]_A	I	Selection pins for Channel Ax emphasis (See emphasis Configuration Table) w/ 100K-Ohm internal pull up
G6, J6, K5	D[0:2]_B	I	Selection pins for Channel Bx emphasis (See emphasis Configuration Table) w/ 100K-Ohm internal pull up
B5	DE_A	I	De-emphasis enable input for Channel A0, A1, A2 and A3 with internal 100K-Ohm pull-up resistor. Set high selects output de-emphasis and set low selects output pre-emphasis.

H5	DE_B	I	De-emphasis enable input for Channel B0, B1, B2 and B3 with internal 100K-Ohm pull-up resistor. Set high selects output de-emphasis and set low selects output pre-emphasis.
F8	LB#	I	Input with internal 100K-Ohm pull-up resistor. LB# = High or open for normal operation. LB# = Low for loopback connection of A_RX to A_TX and B_TX.
G5	MODE	I	Input switch between pin control and I2C control with internal 100k-ohm pull-up resistor. A LVCMOS high level selects input pin control, and disables I2C operation. Note, during startup, input status of the control pin (LB#, RESET#, PD#, RXD_A/B, SEL0-2_A/B, D0-2_A/B, S0-1_A/B, DE_A/B) will be latched to the initial state of some I2C control pins only once.
C6	PD#	I	Input with internal 100K-Ohm pull-up resistor, PD# =High or open is normal operation, PD# =Low disable the IC, and set IC to power down mode, both input and output go Hi-Z.
D6	NC		No Connect
C5	NC		No Connect
J5	RESET#	I	RESET# is an active low channel reset input for Channel A0, B0, A1, B1, A2, B2, A3 and B3 with internal 100K-Ohm pull-up resistor. When low, the receiver detection cycle is reset, and normal detection cycle is started after the pin goes high.
E10	RX50_A	O	Receiver detect output pin for Channel A0. RX50_A=High indicates that a 50-Ohm termination was sensed at the A0TX+/- outputs.
F1	RX50_B	O	Receiver detect output pin for Channel B0. RX50_B=High indicates that a 50-Ohm termination was sensed at the B0TX+/- outputs.
E7	RXD_A	I	Receiver detect enable input for Channel A0, A1, A2 and A3 with internal 100K-Ohm pull-up resistor.
F4	RXD_B	I	Receiver detect enable input for Channel B0, B1, B2 and B3 with internal 100K-Ohm pull-up resistor.
E6, E8	S[0:1]_A	I	Selection pins for Channel Ax output level (see Output Swing Configuration Table) w/ 100K-Ohm internal pull up
F5, F3	S[0:1]_B	I	Selection pins for Channel Bx output level (see Output Swing Configuration Table) w/ 100K-Ohm internal pull up
A5	SCL	I/O	I2C SCL clock input. Up to 3.3V input tolerance.
A6	SDA	I/O	I2C SDA data input. Up to 3.3V input tolerance
E1, E2, E3	SEL[0:2]_A	I	Selection pins for Channel Ax equalization (see Equalizer Configuration Table) w/ 100K-Ohm internal pull up

F10, F9, F7	SEL[0:2]_B	I	Selection pins for Channel Bx Equalization (see Equalizer Configuration Table) w/ 100K-Ohm internal pull up
E9	SIG_A	O	Signal detect output pin for Channel A0. SIG_A=High represents a input signal > threshold at the differential inputs.
F2	SIG_B	O	Signal detect output pin for Channel B0. SIG_B=High represents a input signal > threshold at the differential inputs.
<b>Power Pins</b>			
B2, B3, B8, B9, C2, C3, C8, C9, H2, H3, H8, H9, J2, J3, J8, J9	GND	PWR	Supply Ground
A1, A4, A7, A10, B6, D1, D4, D7, D10, G1, G4, G7, G10, K1, K4, K7, K10	VDD	PWR	1.2V Supply Voltage

## DESCRIPTION of OPERATION

### Configuration Modes

Device configuration can be performed in two ways depending on the state of the MODE input. MODE determines whether IC configuration status is from the input pins or via I2C control. When MODE is set high, the configuration input pins set the configuration operating state as stored in configuration registers. While MODE is set high, changes to these control registers are disabled and the initial condition is protected from any changes to insuring a known operating state. When the MODE pin is low, reprogramming of these control registers via I2C is allowed. Note that the MODE pin is not latched, and is always active to enable or disable I2C access.

During initial power-on, the value at the configuration input pins: LB#, RESET#, PD#, RXD\_A and RXD\_B, DE\_A, DE\_B, SEL0\_A, SEL1\_A, SEL2\_A, D0\_A, D1\_A, D2\_A, S0\_A, S1\_A, SEL0\_B, SEL1\_B, SEL2\_B, D0\_B, D1\_B, D2\_B, S0\_B, S1\_B, will be latched to the configuration registers as initial startup states.

## Equalizer Configuration

The PI2EQX5804 input equalizer compensates for signal attenuation and Inter-Symbol Interference (ISI) resulting from long signal traces or cables, vias, signal crosstalk and other factors, by boosting the gain of high-frequency signal components. Because either too little, or too much, signal compensation may be non-optimal eight levels are provided to adjust for any application.

Equalizer configuration is performed in two ways determined by the state of the MODE pin. When the device first powers up, the SELx\_[A:B] input pins are read into the appropriate control registers to set the equalization characteristic. If the MODE pin is low, reprogramming of these control registers via I2C is allowed.

Each group of four channels, A and B, has separate equalization control, and all four channels within the group are assigned the same configuration state. The Equalizer Selection table below describes pin strapping options and associated operation of the equalizer. Refer to the section on I2C programming for information on software configuration of the equalizer.

### Equalizer Selection

SEL2_[A:B]	SEL1_[A:B]	SEL0_[A:B]	@1.25GHz	@2.5GHz
0	0	0	0.5dB	1.2dB
0	0	1	0.6dB	1.5dB
0	1	0	1.0dB	2.6dB
0	1	1	1.9dB	4.3dB
1	0	0	2.8dB	5.8dB
1	0	1	3.6dB	7.1dB
1	1	0	5.0dB	9.0dB
1	1	1	7.7dB	12.3dB

## Output Configuration

The PI2EQX5804 provides flexible output strength and emphasis controls to provide the optimum signal to pre-compensate for losses across long trace or noisy environments so that the receiver gets a clean eye opening. Control of output configuration is grouped for the A and B channels, so that each channel within the group has the same setting.

Output configuration is performed in two ways depending on the state of the MODE pin. When the device first powers up, the Sx\_[A:B], and Dx\_[A:B] input pins are read into the appropriate control registers to set the power-on state. If the MODE pin is low, reprogramming of these control registers via I2C is allowed.

The Output Swing Control table shows available configuration settings for output level control, as specified using the Sx\_y pins and registers.

### Output Swing Control

S1_[A:B]	S0_[A:B]	Swing (Diff. VPP)
0	0	1V
0	1	0.5V
1	0	0.7V
1	1	0.9V

Emphasis settings are determined by the state of the DEx<sub>y</sub> input pins and configuration registers, as shown in the Output De-emphasis table below. De-Emphasis is selected as the default power-on mode in following the PCI Express specification, but can be changed to Pre-emphasis via reprogramming the Loopback and Emphasis Control register using the I2C interface.

### Output De-emphasis Adjustment

D2_[A:B]	D1_[A:B]	D0_[A:B]	De-emphasis
0	0	0	0dB
0	0	1	-2.5dB
0	1	0	-3.5dB
0	1	1	-4.5dB
1	0	0	-5.5dB
1	0	1	-6.5dB
1	1	0	-7.5dB
1	1	1	-8.5dB

### Input Level Detect

An input level detect and output squelch function is provided on each channel to eliminate re-transmission of input noise. A continuous signal level below the  $V_{th}$  threshold causes the output driver to go to a high-impedance state, so that both the positive and negative output signal are pulled to  $V_{DD}$  by the internal pull-up resistors. This feature supports the L0s PCI Express Electrical Idle state.

### Receiver Detect

Automatic Receiver Detection is a feature that can set the number of active channels. By sensing the presence of a load device on the output, the channel can be automatically enabled for operation. This allows the PI2EQX5804 to configure itself properly depending on the devices it is communicating with, whether it is a 4-lane, 3-lane, 2-lane or just 1-lane device or adapter card.

Receiver Detect is enabled by the RXD<sub>A</sub>, or RXD<sub>B</sub> pins, or alternatively via I2C programming. When RXD<sub>A</sub> or RXD<sub>B</sub> is set to low, then the Receiver Detect operation for that group of channel is disabled, and those channels go directly to 50-Ohm input termination to ground and 50-Ohm output termination to VDD (for a valid differential channel input level) or to 2K-Ohm (if the signal level is less than the threshold level).

(Continued)

The RESET# input is used to reset the receiver detect state machine to its initial state. The start of the receiver detect cycle starts when RESET# transitions from low to high.

When a Receiver Detect cycle is begins the differential channel pins are enabled with a 2K-Ohm pullup to Vdd. A 50-Ohm Receiver termination will change the pin level. This pin level is evaluated after a fixed time-out, and the channel is then set into the proper operating state. The output signals RX50\_A and RX50\_B represent the receiver detect result for their specific channels.

The I/O Operation table summaries the relationships and operation of receiver detect and other signals involved with I/O control.

**Table 4 - I/O Operation Control**

Control Inputs			Detection States		Data Channel I/O		
PD#	RXD_x	RESET#	RX50	SIG_x	Input Termination	Output Termination	Mode
0	X	X	X	X	Hi-Z	Hi-Z	Full IC power down, all channels disabled
1	0	0	X	X	Hi-Z	2K-Ohm pull-up	Channel disabled, output pulls to Vdd. Receiver detect reset
1	0	1	X	0	50-Ohm pull-down	2K-Ohm pull-up	Channel enabled, no input signal, output pulls to Vdd. Receiver detect disabled
1	0	1	X	1	50-Ohm pull-down	50-Ohm pull-up	Channel enabled, valid input signal detected, output driving. Receiver detect disabled.
1	1	0	X	X	Hi-Z	2K-Ohm pull-up	Channel disabled. Receiver detect reset.p
1	1	1	0	X	Hi-Z	2K-Ohm pull-up	Channel disabled, output pulls to Vdd. Receiver detect enabled, no receiver detected.
1	1	1	1	0	50-Ohm pull-down	2K-Ohm pull-up	Channel inactive, output pulls to Vdd. Receiver detect enabled, receiver detected. No input signal
1	1	1	1	1	50-Ohm pull-down	50-Ohm pull-up	Channel active, valid input signal detected, output driving. Receiver detect enabled, load detected.



**Loopback Operation**

Each lane of the 5804 provides a loopback mode for test purposes which is controlled by a strapping pin and I2C register bit. The LB# pin controls all lanes together. When this pin is high normal data mode is enabled. When LB# is low the loopback mode is enabled. The figure below diagrams this operation. Loopback is not intended to be dynamically switched, and the normal system application is to initialize to one configuration or the other.

The Loopback mode can also support mux/demux operation. Using I2C configuration, unused inputs and outputs can be disabled to minimize power and unnecessary noise.

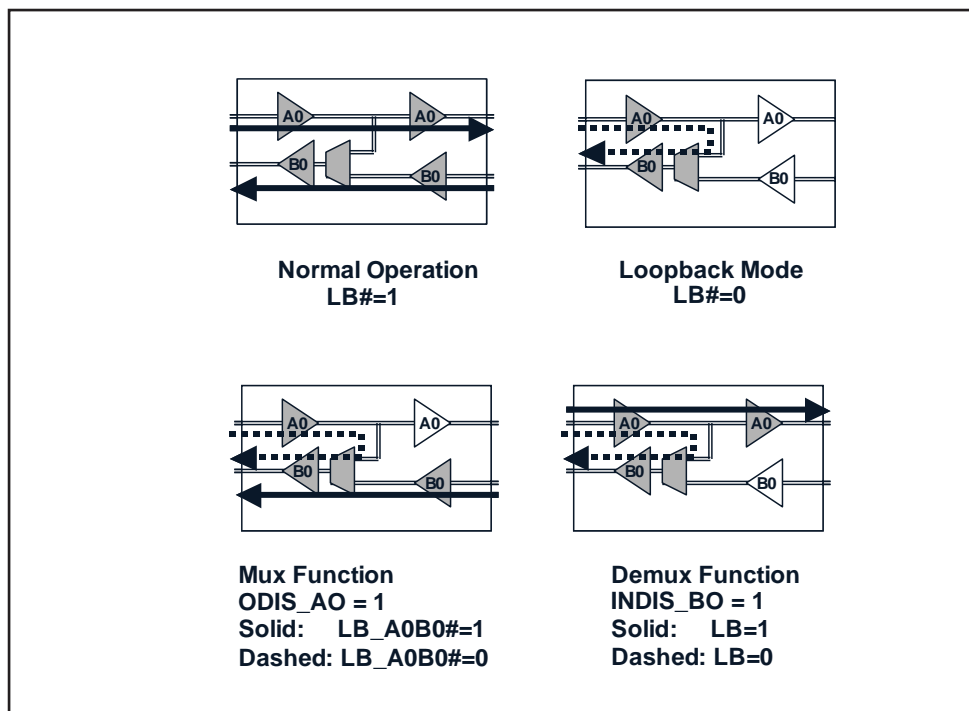

**Loopback Modes**



## I2C Operation

The integrated I2C interface operates as a slave device, supporting standard rate operation of 100Kbps, with 7-bit addressing mode, with support for offset byte-write and read. The data byte format is 8 bit bytes. The bytes must be accessed in sequential order from the lowest to the highest byte with the ability to stop after any complete byte has been transferred. Address bits A4, A1 and A0 are programmable to support multiple chips environment. The data is loaded until a Stop sequence is issued.

Note that the I2C inputs, SCL and SDA operate at 1.2V logic levels and are 3.3V tolerant.

## Configuration Register Summary

Byte	Mnemonic	Function
0	SIG	Signal Detect, indicates valid input signal level
1	RX50	Receiver Detect Output, indicates whether a receiver load was detected
2	LBEC	Loopback and Emphasis Control, provides for control of the loopback function and emphasis mode (pre-emphasis or de-emphasis)
3	INDIS	Channel Input Disable, controls whether s channels input buffer is enabled or disabled
4	OUTDIS	Channel Output Disable: Controls whether a channels output buffer is enabled or disabled
5	RESET	Channel Reset
6	PWR	Power Down Control, enables power down for each channel individually
7	RXDE	Receiver Detect Enable, controls the receiver detect operation
8	AEOC	A-Channels Equalizer and Output Control
9	AEOC	B-Channels Equalizer and Output Control
10	RSVD	Reserved
11	RSVD	Reserved

### Transferring Data

Every byte put on the SDA line must be 8-bits long. Each byte has to be followed by an acknowledge bit. Data is transferred with the most significant bit (MSB) first (see the I<sup>2</sup>C Data Transfer diagram). The PI2EQX5804 will never hold the clock line SCL LOW to force the master into a wait state.

Note: Byte-write and byte-read transfers have a fixed offset of 0x00, because of the very small number of configuration bytes. An offset byte presented by a host to the PI2EQX5804 is not used.

### Addressing

Up to eight PI2EQX5804 devices can be connected to a single I2C bus. The Pi2EQX5804 supports 7-bit addressing, with the LSB indicating either a read or write operation. The address for a specific device is determined by the A0, A1 and A4 input pins.

Address Assignment							
A6	A5	A4	A3	A2	A1	A0	R/W
1	1	Program	0	0	Programmable		1=R, 0=W

### Acknowledge

Data transfer with acknowledge is required from the master. When the master releases the SDA line (HIGH) during the acknowledge clock pulse, the PI2EQX5804 will pull down the SDA line during the acknowledge clock pulse so that it remains stable LOW during the HIGH period of this clock pulse as indicated in the I2C Data Transfer diagram. The PI2EQX5804 will generate an acknowledge after each byte has been received.

### Data Transfer

A data transfer cycle begins with the master issuing a start bit. After recognizing a start bit, the PI2EQX5804 will watch the next byte of information for a match with its address setting. When a match is found it will respond with a read or write of data on the following clocks. Each byte must be followed by an acknowledge bit, except for the last byte of a read cycle which ends with a stop bit. For a write cycle, the first data byte following the address byte is a dummy or fill byte that is not used by the PI2EQX5804. This byte is provided to provided compatibility with systems implementing 10-bit addressing. Data is transferred with the most significant bit (MSB) first.

## Register Description

### Byte 0 - Signal Detect (SIG)

SIG<sub>xy</sub>=0=low input signal, SIG<sub>xy</sub>=1=valid input signal

Bit	7	6	5	4	3	2	1	0
Name	SIG_A0	SIG_B0	SIG_A1	SIG_B1	SIG_A2	SIG_B2	SIG_A3	SIG_B3
Type	R	R	R	R	R	R	R	R
Power-on State	X	X	X	X	X	X	X	X

Note: R=Read only, W=Write only, R/W=Read and Write, X=Undefined, rsvd=reserved for future use

The Signal Detect register provides information on the instantaneous status of the channel input from the Input Level Threshold Detect circuit. If the input level falls below the V<sub>th</sub>- level the relevant SIG<sub>xy</sub> bit will be 0, indicating a low-level noise or electrical idle input, resulting in the outputs going to the high-impedance off state or squelch mode. If the input level is above V<sub>th</sub>-, then SIG<sub>xy</sub> is 1, indicating a valid input signal, and active signal recovery operation.

### Byte 1 - Receiver Detect Output Register (RX50)

LB<sub>xyxy</sub>#=0=loopback mode, LB<sub>xyxy</sub>#=1=normal mode, DE<sub>x</sub>=0=pre-emphasis, DE<sub>x</sub>=1=de-emphasis

Bit	7	6	5	4	3	2	1	0
Name	RX50_A0	RX50_B0	RX50_A1	RX50_B1	RX50_A2	RX50_B2	RX50_A3	RX50_B3
Type	R	R	R	R	R	R	R	R
Power-on State	X	X	X	X	X	X	X	X

Note: R=Read only, W=Write only, R/W=Read and Write, X=Undefined, rsvd=reserved for future use

The RX50<sub>xy</sub> bits report the result of a receiver detection cycle. One bit is assigned for each channel of the device. RX50<sub>xy</sub> is at a logic 1 level indicating a load and receiver was detected. When RX50<sub>xy</sub> is 0 then a load device was not detected. The RX50 register is read-only, and is undefined after power-up until a Receiver Detection cycle completes.

### Byte 2 - Loopback and Emphasis Control Register (LBEC)

LB<sub>xyxy</sub>#=0=loopback mode, LB<sub>xyxy</sub>#=1=normal mode, DE<sub>x</sub>=0=pre-emphasis, DE<sub>x</sub>=1=de-emphasis

Bit	7	6	5	4	3	2	1	0
Name	LB_A0B0#	LB_A1B1#	LB_A2B2#	LB_A3B3#	DE_A	DE_B	rsvd	rsvd
Type	R/W	R/W	R/W	R/W	R/W	R/W	R	R
Power-on State	LB#	LB#	LB#	LB#	DE_A	DE_B	X	X

Note: R=Read only, W=Write only, R/W=Read and Write, X=Undefined, rsvd=reserved for future use

Individual control for each lane is provided for the loopback function via this register.

### BYTE 3 - Channel Input Disable (INDIS)

INDIS\_xy=0=enable input, INDIS\_xy=1=disable input

Bit	7	6	5	4	3	2	1	0
Name	INDIS_A0	INDIS_B0	INDIS_A1	INDIS_B1	INDIS_A2	INDIS_B2	INDIS_A3	INDIS_B3
Type	R/W	R/W	R/W	R/W	R/W	R/W	R/W	R/W
Power-on State	0	0	0	0	0	0	0	0

Note: R=Read only, W=Write only, R/W=Read and Write, X=Undefined, rsvd=reserved for future use

The Channel Input Disable register, provides control over the input buffer of each channel independently. When and INDIS\_xy bit is logic 1, then the input buffer is switched off and the input termination is high impedance. This feature can be used for PCB testing, and when only one input is used during Loopback as a demux function. When INDIS\_xy is at a logic 0 state then the input buffer is enabled (normal operating mode).

### BYTE 4 - Channel Output Disable (OUTDIS)

ODIS\_xy=0=enable output, ODIS\_xy=1=disable output

Bit	7	6	5	4	3	2	1	0
Name	ODIS_A0	ODIS_B0	ODIS_A1	ODIS_B1	ODIS_A2	ODIS_B2	ODIS_A3	ODIS_B3
Type	R/W	R/W	R/W	R/W	R/W	R/W	R/W	R/W
Power-on State	0	0	0	0	0	0	0	0

Note: R=Read only, W=Write only, R/W=Read and Write, X=Undefined, rsvd=reserved for future use

The Channel Output Disable register, allows control over the output buffer of each channel independently. When and OUTDIS\_xy bit is logic 1, then the output buffer is switched off and the termination is high impedance. This feature can be used for PCB testing, and when only one output is used during Loopback as a mux function. When INDIS\_xy is at a logic 0 state then the input buffer is enabled (normal operating mode).

### BYTE 5 - Channel Reset (RESET)

RES\_xy# =0=reset, RES\_xy# =1=normal operation. Latch from RESET# input at startup

Bit	7	6	5	4	3	2	1	0
Name	RES_A0#	RES_B0#	RES_A1#	RES_B1#	RES_A2#	RES_B2#	RES_A3#	RES_B3#
Type	R/W	R/W	R/W	R/W	R/W	R/W	R/W	R/W
Power-on State	RESET#	RESET#	RESET#	RESET#	RESET#	RESET#	RESET#	RESET#

Note: R=Read only, W=Write only, R/W=Read and Write, X=Undefined, rsvd=reserved for future use

The Channel Reset register allows for restart of an individual channels Receiver Detect function. A transition from 0 to 1 initiates a new Receiver Detect cycle (if the channel is enabled and receiver detect is enabled). While static at 0 or 1, the RES\_zy# bit will have no effect on operation. The Channel Reset bits are read/write allowing the current state to be checked.

**BYTE 6 - Power Down Control (PWR)**

PD\_xy# =0=channel off/power down, PD\_xy# =1=normal operation, Latch from PD# input at startup

Bit	7	6	5	4	3	2	1	0
<b>Name</b>	<b>PD_A0#</b>	<b>PD_B0#</b>	<b>PD_A1#</b>	<b>PD_B1#</b>	<b>PD_A2#</b>	<b>PD_B2#</b>	<b>PD_A3#</b>	<b>PD_B3#</b>
Type	R/W	R/W	R/W	R/W	R/W	R/W	R/W	R/W
Power-on State	PD#	PD#	PD#	PD#	PD#	PD#	PD#	PD#

Note: R=Read only, W=Write only, R/W=Read and Write, X=Undefined, rsvd=reserved for future use

The Power Down Control register allows for individual control over each channel for power savings. When PD\_xy# is logic 0 the channel is turned off. When PD\_xy# is 1 then the channel is enabled for normal operation.

**BYTE 7 - Receiver Detect Enable (RXD)**

RXD\_xy =0=channel off/power down, RXD\_xy =1=normal operation, Latch from PD# input at startup

Bit	7	6	5	4	3	2	1	0
<b>Name</b>	<b>RXD_A0</b>	<b>RXD_B0</b>	<b>RXD_A1</b>	<b>RXD_B1</b>	<b>RXD_A2</b>	<b>RXD_B2</b>	<b>RXD_A3</b>	<b>RXD_B3</b>
Type	R/W	R/W	R/W	R/W	R/W	R/W	R/W	R/W
Power-on State	RXD_A	RXD_B	RXD_A	RXD_B	RXD_A	RXD_B	RXD_A	RXD_B

Note: R=Read only, W=Write only, R/W=Read and Write, X=Undefined, rsvd=reserved for future use

The Receiver Detect Enable register allows for control of the receiver detect state machine for each individual channel. When RXD\_xy is set to 0, then the receiver detect function is disabled. When RXD\_xy is logic 1, then the receiver detect state machine is enabled for operation. The initial state of the register bits are determined by the RXD\_A and RXD\_B input pins during power-up.

**BYTE 8 - A-Channels Equalizer and Output Control (AEOC)**

SELx\_A: Equalizer configuration, Dx\_A: Emphasis control, Sx\_A: Output level control (see Configuration Table)

Bit	7	6	5	4	3	2	1	0
<b>Name</b>	<b>SEL0_A</b>	<b>SEL1_A</b>	<b>SEL2_A</b>	<b>D0_A</b>	<b>D1_A</b>	<b>D2_A</b>	<b>S0_A</b>	<b>S1_A</b>
Type	R/W	R/W	R/W	R/W	R/W	R/W	R/W	R/W
Power-on State	SEL0_A	SEL1_A	SEL2_A	D0_A	D1_A	D2_A	S0_A	S1_A

Note: R=Read only, W=Write only, R/W=Read and Write, X=Undefined, rsvd=reserved for future use

The A-Channels Equalizer and Output Control register is used to control the configuration of the input equalizer and output emphasis and levels of the four A channels. These register bits are loaded from the input configuration pins of the same name at power-on. These bits may be changed if the MODE# input is set to allow I2C configuration. Please refer to the tables (1) Equalizer Configuration, (2) Output Swing Configuration and

(3) Output Emphasis Configuration earlier in this document for setting information. All four A channels get the same configuration settings.

**BYTE 9 - B-Channels Equalizer and Output Control (BEOC)**

SELx\_B: Equalizer configuration,

Dx\_B: Emphasis control,

Sx\_B: Output level control (see Configuration Table)

Bit	7	6	5	4	3	2	1	0
Name	<b>SEL0_B</b>	<b>SEL1_B</b>	<b>SEL2_B</b>	<b>D0_B</b>	<b>D1_B</b>	<b>D2_B</b>	<b>S0_B</b>	<b>S1_B</b>
Type	R/W	R/W	R/W	R/W	R/W	R/W	R/W	R/W
Power-on State	SEL0_B	SEL1_B	SEL2_B	D0_B	D1_B	D2_B	S0_B	S1_B

Note: R=Read only, W=Write only, R/W=Read and Write, X=Undefined, rsvd=reserved for future use

The B-Channels Equalizer and Output Control register is used to control the configuration of the input equalizer and output emphasis and levels of the four B channels. These register bits are loaded from the input configuration pins of the same name at power-on. These bits may be changed if the MODE# input is set to allow I2C configuration. Please refer to the tables (1) Equalizer Configuration, (2) Output Swing Configuration and (3) Output Emphasis Configuration earlier in this document for setting information. All four B channels get the same configuration settings.

BYTE 10 - Reserved

BYTE 11 - Reserved

Reserved Bytes 10 and 11 are also visible via the I2C interface. These bytes are R/W, are initialized to 0 at power up, are used for IC manufacturing test purposes and should not be changed for normal operation.

**Start & Stop Conditions**

A HIGH to LOW transition on the SDA line while SCL is HIGH indicates a START condition. A LOW to HIGH transition on the SDA line while SCL is HIGH defines a STOP condition, as shown in the figure below.

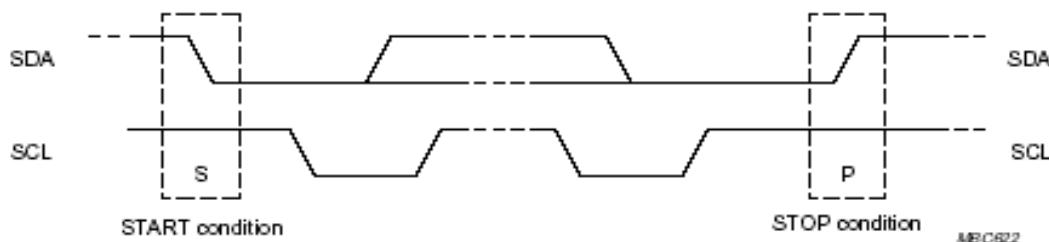

I<sup>2</sup>C START and STOP conditions.

**I<sup>2</sup>C Data Transfer**

**1. Read sequence**

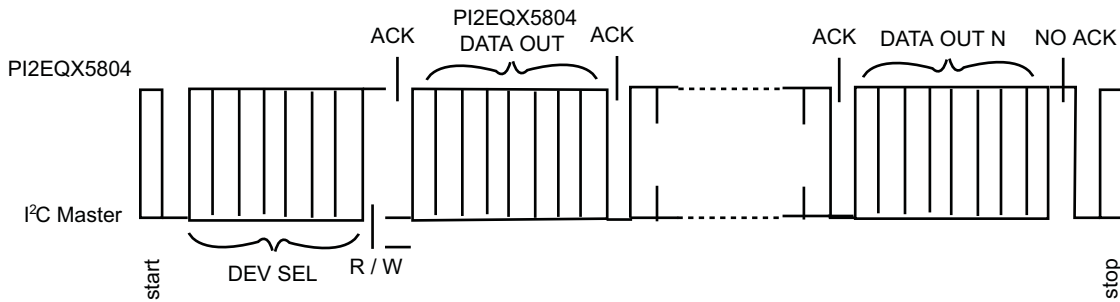

**2. Write sequence**

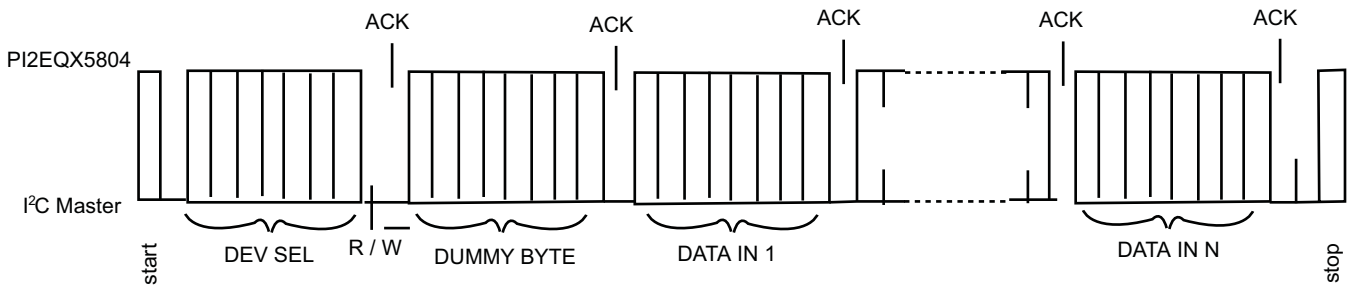

**3. Combined sequence**

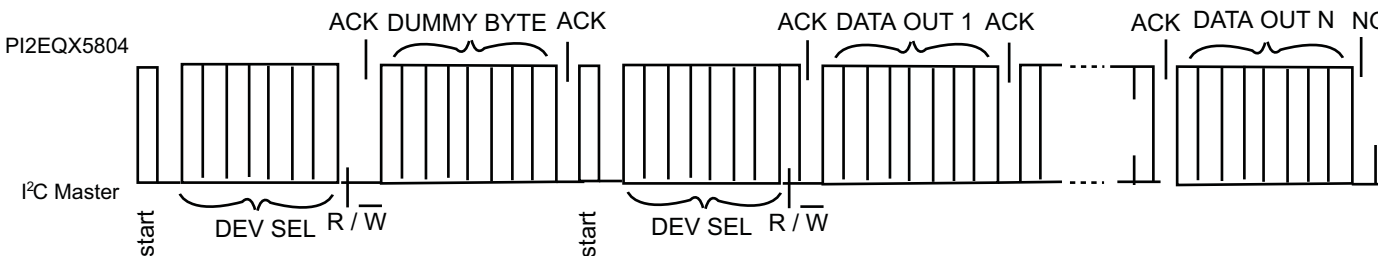

**Notes:**

1. only block read and block write from the lowest byte are supported for this application.
2. for some I2C application, an offset address byte will be presented at the second byte in write command, which is called dummy byte here and will be simply ignored in this application for correct interoperation.



**Maximum Ratings**

(Above which useful life may be impaired. For user guidelines, not tested.)

Storage Temperature.....	-65°C to +150°C
Supply Voltage to Ground Potential.....	-0.5V to +2.5V
DC SIG Voltage.....	-0.5V to V <sub>DD</sub> +0.5V
Current Output .....	-25mA to +25mA
Power Dissipation Continuous .....	1W
Operating Temperature.....	0 to +70°C

**Note:** Stresses greater than those listed under MAXIMUM RATINGS may cause permanent damage to the device. This is a stress rating only and functional operation of the device at these or any other conditions above those indicated in the operational sections of this specification is not implied. Exposure to absolute maximum rating conditions for extended periods may affect reliability.

**AC/DC Electrical Characteristics**

**Power Supply Characteristics** (V<sub>DD</sub> = 1.2 ±0.05V, T<sub>A</sub> = 0 TO 70°C)

Symbol	Parameter	Conditions	Min.	Typ.	Max.	Units
I <sub>DDactive</sub>	Power supply current - active	All channels switching			800	mA
I <sub>DDstandby</sub>	Power supply current - standby	PD# = 0		5	10.	mA
I <sub>DD-channel</sub>	Power supply current - per channel, Active			50		mA

**AC Performance Characteristics** (V<sub>DD</sub> = 1.2 ±0.05V, T<sub>A</sub> = 0 TO 70°C)

Symbol	Parameter	Conditions	Min.	Typ.	Max.	Units
T <sub>pd</sub>	Channel latency from input to output			750		ps

**CML Receiver Input** (V<sub>DD</sub> = 1.2 ±0.05V, T<sub>A</sub> = 0 TO 70°C)

Symbol	Parameter	Conditions	Min.	Typ.	Max.	Units
ZRX-DIFF-DC	DC Differential Input Impedance		80	100	120	Ohms
ZRX-DC	DC Input Impedance		40	50	60	Ohms
VRX-DIFFP-P	Differential Input Peak-to-peak Voltage		0.175		1.200	V
VRX-CM-ACP	AC Peak Common Mode Input Voltage				150	mV
V <sub>th</sub> -	Signal detect threshold voltage			100	150	mV

**Equalizer**

Symbol	Parameter	Conditions	Min.	Typ.	Max.	Units
J <sub>RS-T</sub>	Residual jitter	Total			0.3	Ulp-p
J <sub>RS-D</sub>	Residual jitter	Deterministic			0.2	Ulp-p
J <sub>RM</sub>	Random jitter	Note 2		1.5		psrms

**Notes**

1. K28.7 pattern is applied differentially at point A as shown in AC test circuit (see figure).
2. Total jitter does not include the signal source jitter. Total jitter (TJ) = (14.1 × RJ + DJ) where RJ is random RMS jitter and DJ is maximum deterministic jitter. Signal source is a K28.5 ± pattern (00 1111 1010 11 0000 0101) for the deterministic jitter test and K28.7 (0011111000) or equivalent for random jitter test. Residual jitter is that which remains after equalizing media-induced losses of the environment of Figure 1 or its equivalent. The deterministic jitter at point B must be from media-induced loss, and not from clock source modulation. Jitter is measured at 0V at point C of the AC test circuit (see figure).

**CML Transmitter Output (VDD = 1.2V ± 0.05V, T<sub>A</sub> = 0 to 70°C)**

Symbol	Parameter	Conditions	Min.	Typ.	Max.	Units
Z <sub>OUT</sub>	Output resistance	Single ended	40	50	60	Ohms
Z <sub>TX-DIFF-DC</sub>	DC Differential TX Impedance		80	100	120	Ohms
V <sub>DIFFP</sub>	Output Voltage Swing, Differential	VTX-D+ - VTX-D-	200		800	mVp-p
V <sub>TX-DIFFP-P</sub>	Differential Peak-to-peak Output Voltage	VTX-DIFFP-P = 2 *  VTX-D+ - VTX-D-	0.4		1.6	V
V <sub>TX-C</sub>	Common-Mode Voltage	VTX-D+ + VTX-D-   / 2		VDD-0.3		V
t <sub>F</sub> , t <sub>R</sub>	Transition Time	20% to 80% (3)			150	ps
C <sub>TX</sub> <sup>(1)</sup>	AC Coupling Capacitor		75		200	nF

**Notes:**

1. Recommended external blocking capacitor.

**Digital I/O DC Specifications (VDD = 1.2V ± 0.05V, T<sub>A</sub> = 0 to 70°C)**

Symbol	Parameter	Conditions	Min.	Typ.	Max.	Units
V <sub>IH</sub>	DC input logic high		VDD/2 +0.2		VDD+0.3	V
V <sub>IL</sub>	DC input logic low		-0.3		VDD/2 -0.2	V
V <sub>OH</sub>	DC output logic high	I <sub>OH</sub> = 4mA	VDD-0.4			V
V <sub>OL</sub>	DC output logic low	I <sub>OL</sub> = 4mA			0.4	V
V <sub>hys</sub>	Hysteresis of Schmitt trigger input		0.2			V
I <sub>IH</sub> <sup>(1)</sup>	Input high current				250	uA
I <sub>IL1</sub> <sup>(2)</sup>	Input low current		-250			uA
I <sub>IL2</sub> <sup>(3)</sup>	Input low current		-500			uA

**Notes:**

1. Includes input signals A1, A2, A4, Dx\_[A:B], DE\_[A:B], LB#, MODE#, PD#, RESET#, RXD\_[A:B], Sx\_[A:B], SCL, SDA, SEL\_x[A:B]
2. For control inputs without pullups: A1, A2, A4, SCL, SDA
3. Control inputs with pull-ups include: Dx\_[A:B], DE\_[A:B], LB#, MODE#, PD#, RESET#, RXD\_[A:B], Sx\_[A:B], SEL\_x[A:B]

**SDA and SCL I/O for I2C-bus ( $V_{DD} = 1.2 \pm 0.05\text{v}$ ,  $T_A = 0$  to  $70^\circ\text{C}$ )**

Symbol	Parameter	Conditions	Min.	Typ.	Max.	Units
$V_{IH}$	DC input logic high		1.1		3.6	V
$V_{IL}$	DC input logic low		-0.3		0.7	V
$V_{OL}$	DC output logic low	$I_{OL} = 3\text{mA}$			0.4	V
$V_{hys}$	Hysteresis of Schmitt trigger input		0.2			V

**Characteristics of the SDA and SCL bus lines for F/S-mode I2C-bus devices<sup>(1)</sup>**

Symbol	Parameter	Conditions	Min.	Typ.	Max.	Unit
$f_{SCL}$	SCL clock frequency		0		100	kHz
$t_{HD;STA}$	Hold time (repeated) START condition. After this period, the first clock pulse is generated		4.0		–	$\mu\text{s}$
$t_{LOW}$	LOW period of the SCL clock		4.7		–	$\mu\text{s}$
$t_{HIGH}$	HIGH period of the SCL clock		4.0		–	$\mu\text{s}$
$t_{SU;STA}$	Set-up time for a repeated START condition		4.7		–	$\mu\text{s}$
$t_{HD;DAT}$	Data hold time		5.0		–	$\mu\text{s}$
$t_{SU;DAT}$	Data set-up time		250		–	ns
$t_r$	Rise time of both SDA and SCL signals		–		100	ns
$t_f$	Fall time of both SDA and SCL signals				300	ns
$t_{SU;STO}$	Set-up time for STOP condition		4.0		–	$\mu\text{s}$
$t_{BUF}$	Buss free time between a STOP and STOP condition		4.7		–	$\mu\text{s}$
$C_b$	Capacitive load for each bus line		–		400	pF

**Notes:**

1. All values referred to  $V_{IHmin}$  and  $V_{ILmax}$  levels.
2. A device must initially provide a hold time of at least 300 ns for the SDA signal (referred to the  $V_{IHmin}$  of the SCL signal) to bridge the undefined region of the falling edge of SCL.

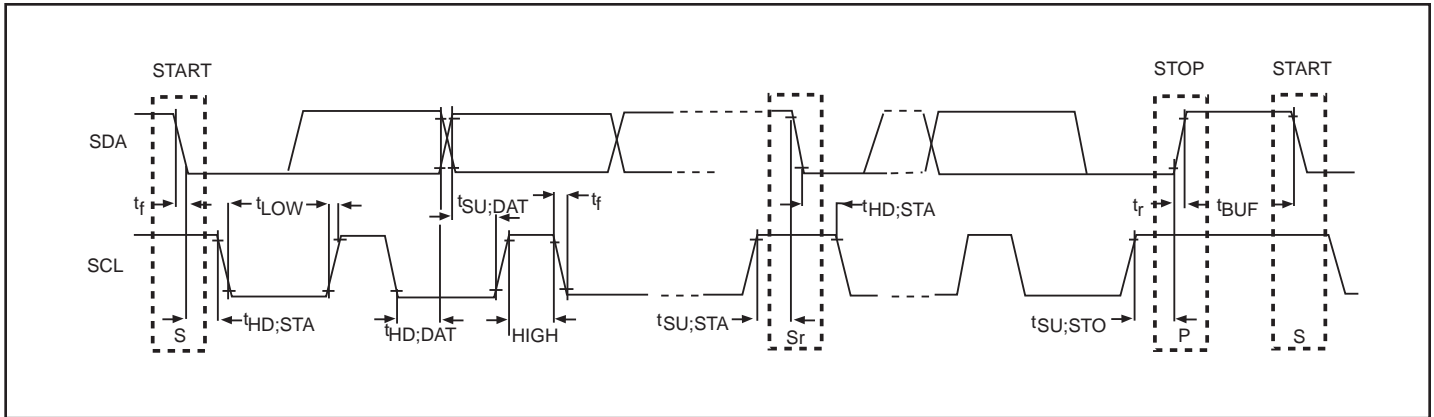

I2C Timing

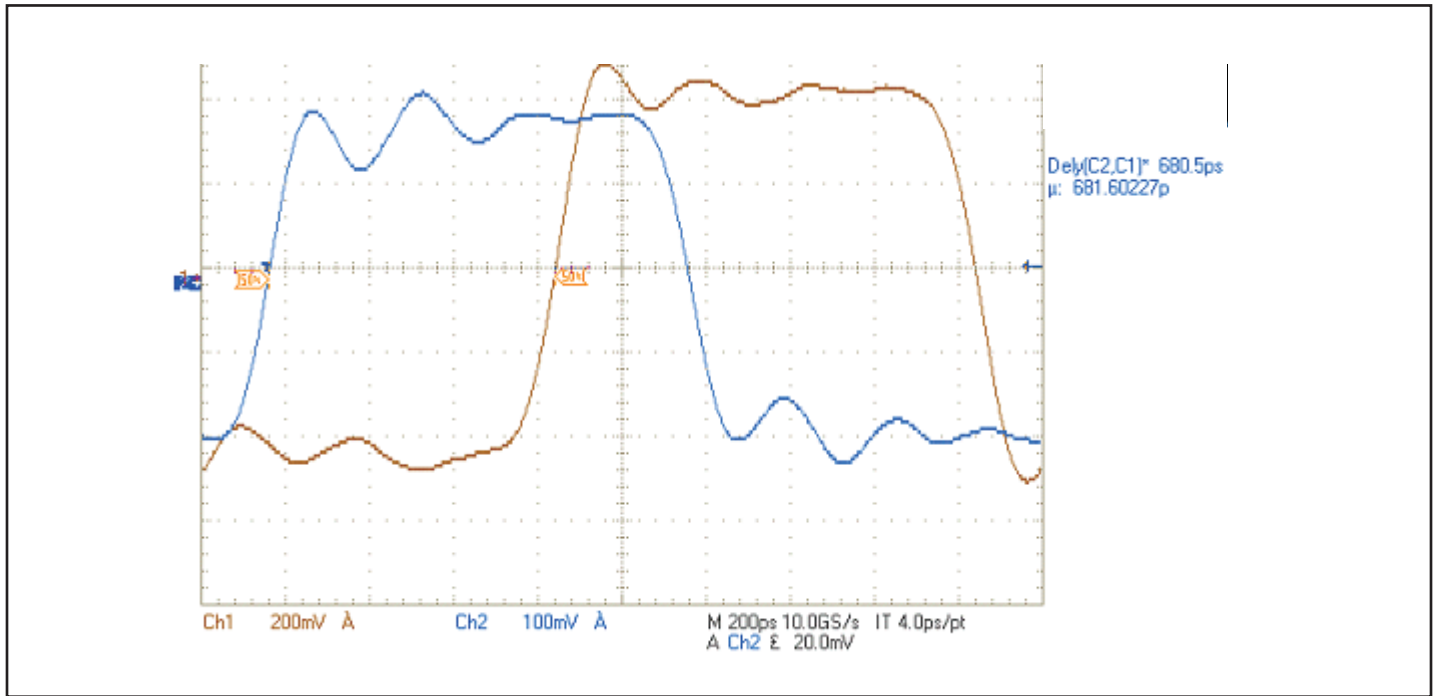

Channel Latency, 5.0 Gbps

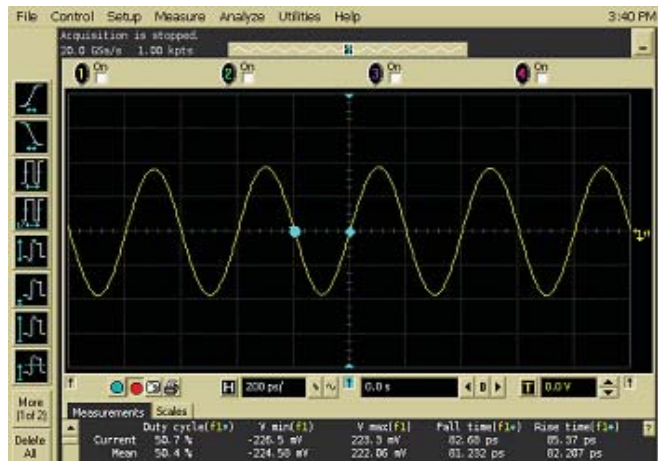
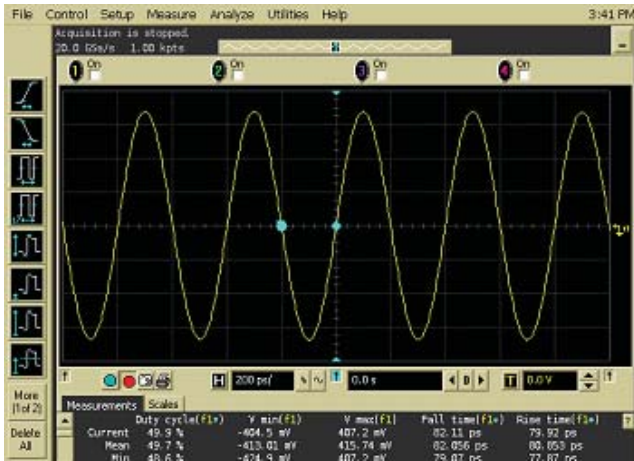

Output Level Settings (1V left, and 0.5V right at 5.0 Gbps)

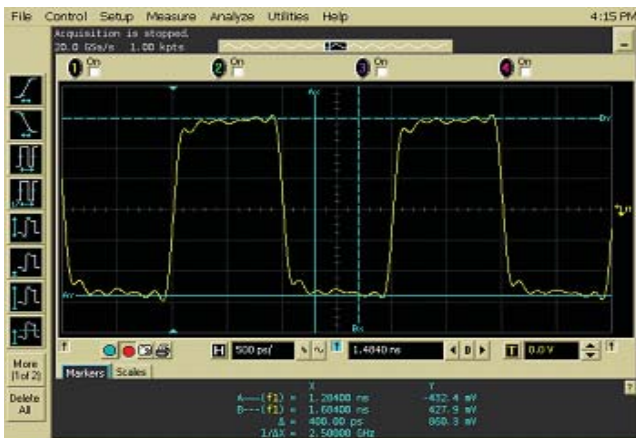

0.0 dB (Dx = 000)



-3.5 dB (Dx = 010)

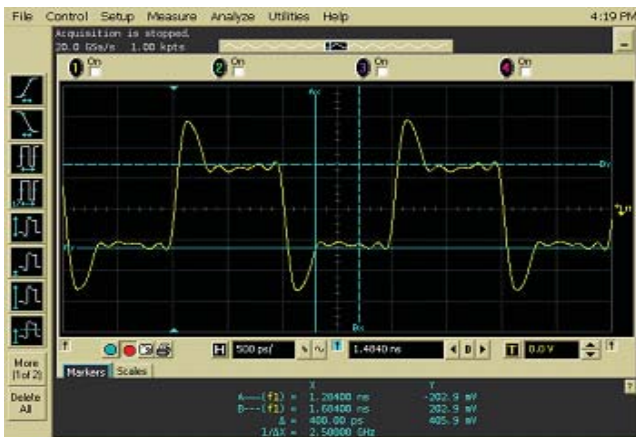

-6.5 dB (Dx = 101)

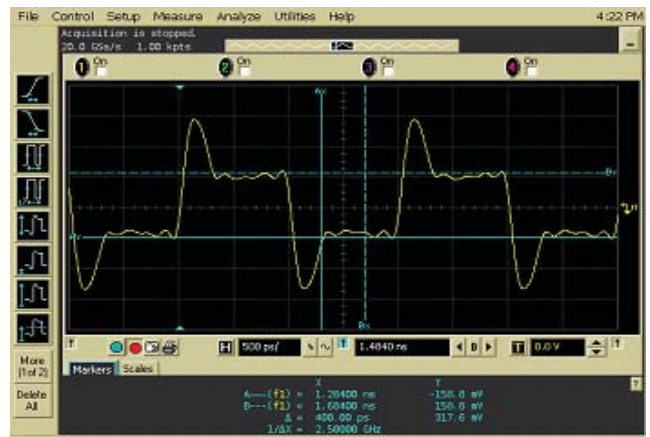

-8.5 dB (Dx = 111)

Output De-emphasis Characteristics



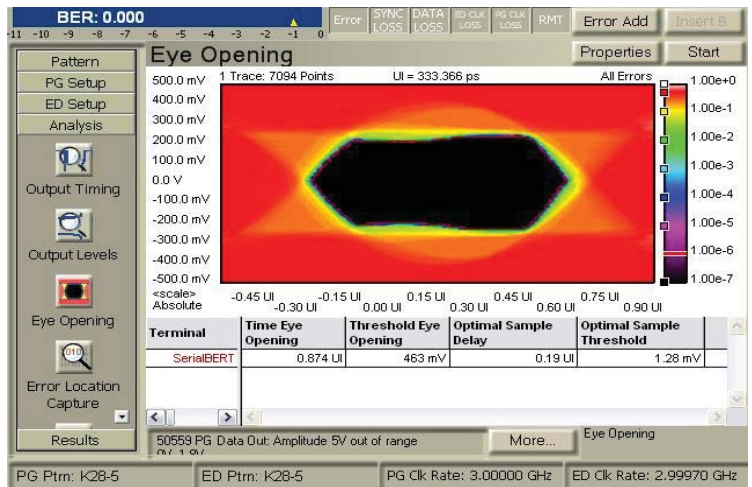
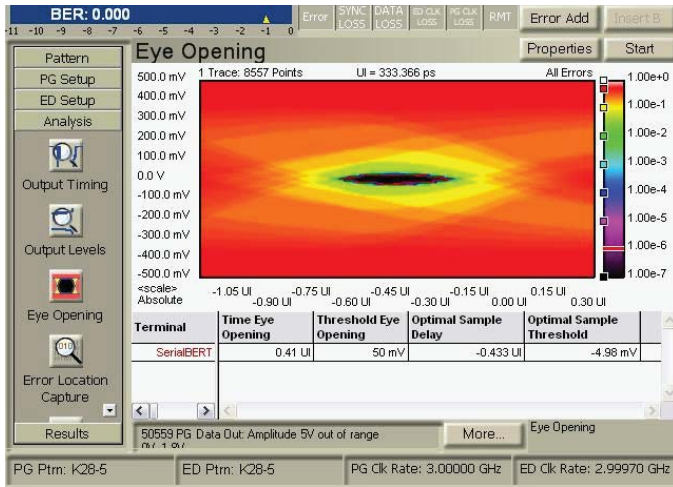

Eye Diagrams 5.0Gbps (input left, output right)



Data Waveforms, 2.5Gbps (left) & 5.0Gbps (right)

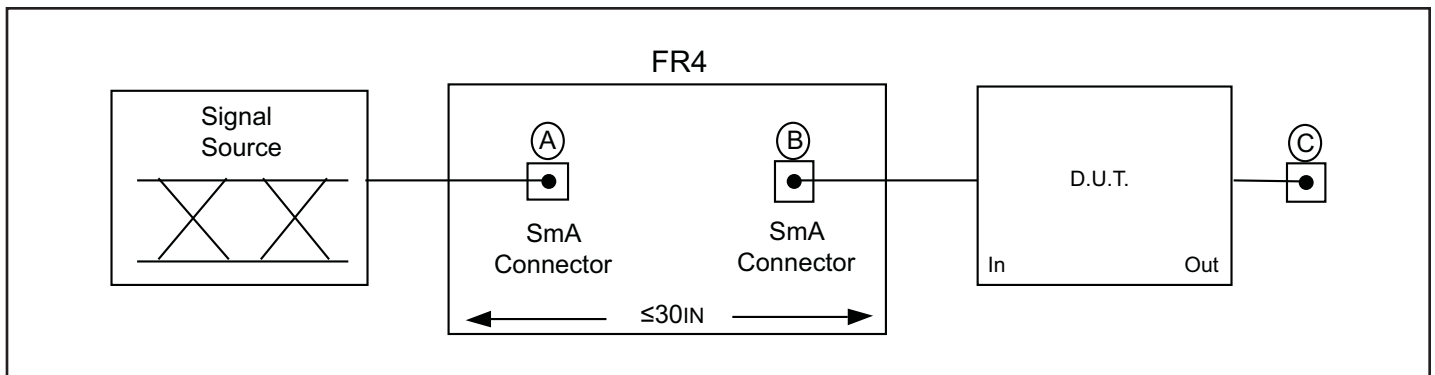

AC Test Circuit Referenced in the Electrical Characteristic Table

**Packaging Mechanical: 100-Ball LFBGA (NJ)**

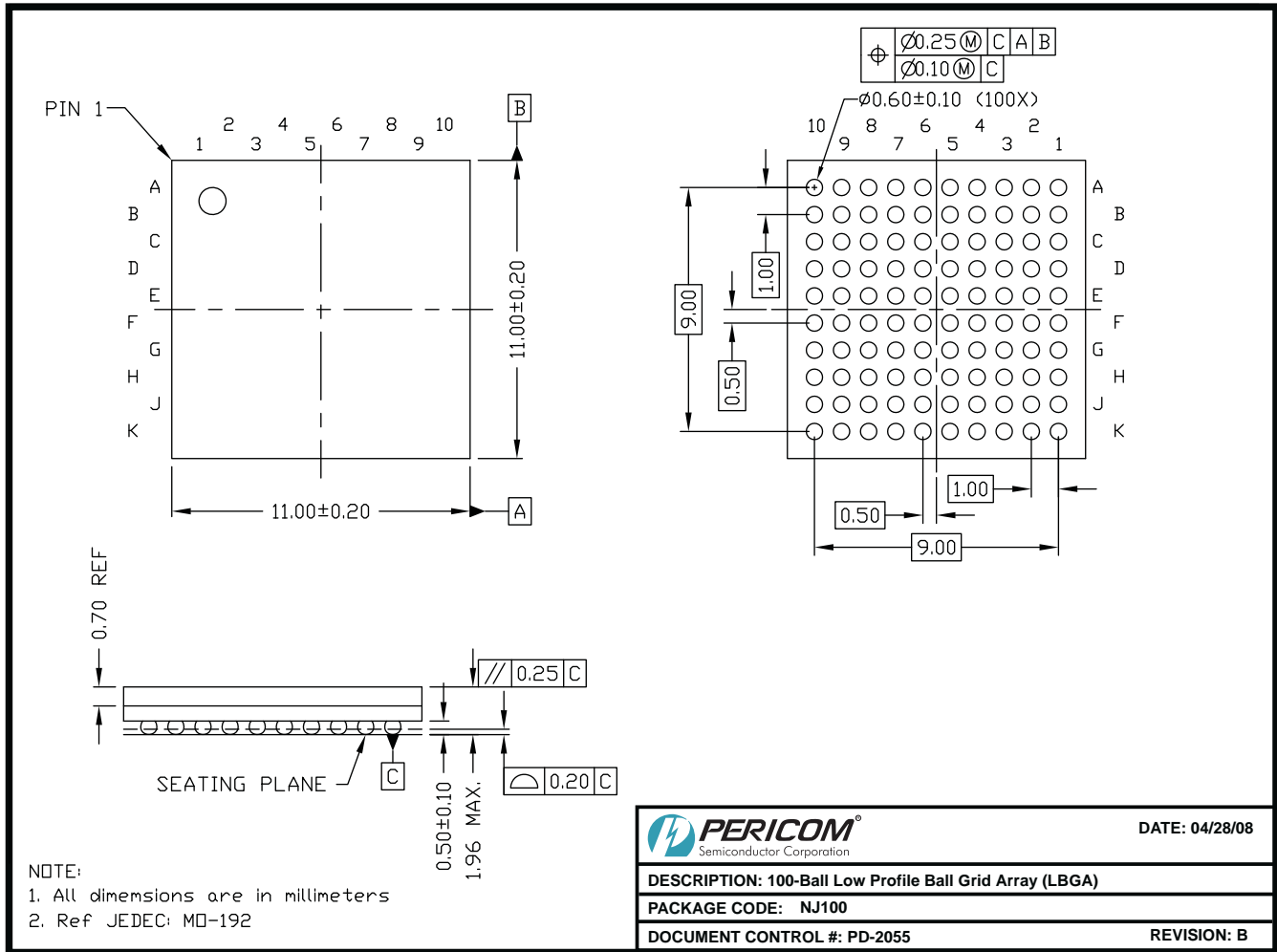

**Ordering Information**

Ordering Number	Package Code	Package Description
PI2EQX5804CNJE	NJ	Pb-free & Green 100-Contact LFBGA

Notes:

- Thermal characteristics can be found on the company web site at [www.pericom.com/packaging/](http://www.pericom.com/packaging/)
- E = Pb-free and Green
- X suffix = Tape/Reel