

# 1Gb C-die DDR3 SDRAM Specification

**Revision 1.0**

**June 2007**

**INFORMATION IN THIS DOCUMENT IS PROVIDED IN RELATION TO SAMSUNG PRODUCTS, AND IS SUBJECT TO CHANGE WITHOUT NOTICE.**

**NOTHING IN THIS DOCUMENT SHALL BE CONSTRUED AS GRANTING ANY LICENSE, EXPRESS OR IMPLIED, BY ESTOPPEL OR OTHERWISE,**

**TO ANY INTELLECTUAL PROPERTY RIGHTS IN SAMSUNG PRODUCTS OR TECHNOLOGY. ALL INFORMATION IN THIS DOCUMENT IS PROVIDED**

**ON AS "AS IS" BASIS WITHOUT GUARANTEE OR WARRANTY OF ANY KIND.**

1. For updates or additional information about Samsung products, contact your nearest Samsung office.
2. Samsung products are not intended for use in life support, critical care, medical, safety equipment, or similar applications where Product failure could result in loss of life or personal or physical harm, or any military or defense application, or any governmental procurement to which special terms or provisions may apply.

**\* Samsung Electronics reserves the right to change products or specification without notice.**

## Revision History

Revision	Month	Year	History
0.0	January	2007	- Revision 0.0 release
0.1	June	2007	- Deleted 800Mbps 5-5-5 speed - Timing Parameters by Speed Grade (13.0) - Input/Output Capacitance (11.0)
1.0	June	2007	- Revision 1.0 specification release.

## Table Contents

1.0 Ordering Information .....	4
2.0 Key Features .....	4
3.0 Package pinout/Mechanical Dimension & Addressing .....	5
3.1 x4 Package Pinout (Top view) : 94ball FBGA Package(78balls + 16 balls of support balls) .....	5
3.2 x8 Package Pinout (Top view) : 94ball FBGA Package(78balls + 16 balls of support balls) .....	6
3.3 x16 Package Pinout (Top view) : 112ball FBGA Package(96balls + 16 balls of support balls) .....	7
3.4 FBGA Package Dimension (x4) .....	8
3.5 FBGA Package Dimension (x8) .....	9
3.6 FBGA Package Dimension (x16) .....	10
4.0 Input/Output Functional Description .....	11
5.0 DDR3 SDRAM Addressing .....	12
6.0 Absolute Maximum Ratings .....	14
6.1 Absolute Maximum DC Ratings .....	14
6.2 DRAM Component Operating Temperature Range .....	14
7.0 AC & DC Operating Conditions .....	14
7.1 Recommended DC operating Conditions (SSTL_1.5) .....	14
8.0 AC & DC Input Measurement Levels .....	15
8.1 AC and DC Logic input levels for single-ended signals .....	15
8.2 Differential swing requirement for differential signals .....	16
8.2.1 Single-ended requirements for differential signals .....	17
8.3 AC and DC logic input levels for Differential Signals .....	18
8.4 Differential Input Cross Point Voltage .....	18
8.5 Slew rate definition for Single Ended Input Signals .....	19
8.5.1 Input Slew Rate for Input Setup Time (tIS) and Data Setup Time (tDS) .....	19
8.5.2 Input Slew Rate for Input Hold Time (tIH) and Data Hold Time (tDH) .....	19
8.6 Slew rate definition for Differential Input Signals .....	19
9.0 AC and DC Output Measurement Levels .....	20
9.1 Single Ended AC and DC Output Levels .....	20
9.2 Differential AC and DC Output Levels .....	20
9.3. Single Ended Output Slew Rate .....	21
9.4 Differential Output Slew Rate .....	21
9.5 Reference Load for AC Timing and Output Slew Rate .....	22
9.6 Overshoot/Undershoot Specification .....	23
9.6.1 Address and Control Overshoot and Undershoot specifications .....	23
9.6.2 Clock, Data, Strobe and Mask Overshoot and Undershoot specifications .....	23
9.7 34 ohm Output Driver DC Electrical Characteristics .....	24
9.7.1 Output Drive Temperature and Voltage sensitivity .....	25
9.8 On-Die Termination (ODT) Levels and I-V Characteristics .....	25
9.8.1 ODT DC electrical characteristics .....	26
9.8.2 ODT Temperature and Voltage sensitivity .....	27
9.9 ODT Timing Definitions .....	28
9.9.1 Test Load for ODT Timings .....	28
9.9.2 ODT Timing Definition .....	28
10.0 Idd Specification Parameters and Test Conditions .....	31
10.1 IDD Measurement Conditions .....	31
10.2 IDD Specifications .....	41
11.0 Input/Output Capacitance .....	43
12.0 Electrical Characteristics and AC timing for DDR3-800 to DDR3-1600 .....	44
12.1 Clock specification .....	44
12.2 Clock Jitter Specification .....	45
12.3 Refresh Parameters by Device Density .....	46
12.4 Standard Speed Bins .....	46
13.0 Timing Parameters by Speed Grade .....	48

## 1.0 Ordering Information

[ Table 1 ] Samsung DDR3 ordering information table

Organization	DDR3-800 (6-6-6)	DDR3-1066 (7-7-7/8-8-8)	DDR3-1333 (8-8-8/9-9-9)	Package
256Mx4	K4B1G0446C-ZCF7	K4B1G0446C-CF8/G8	K4B1G0446C-ZCG9/H9	94 FBGA
128Mx8	K4B1G0846C-ZCF7	K4B1G0846C-CF8/G8	K4B1G0846C-ZCG9/H9	94 FBGA
64Mx16	K4B1G1646C-ZCF7	K4B1G1646C-CF8/G8	K4B1G1646C-ZCG9/H9	112 FBGA

Note :

- Speed bin is in order of CL-tRCD-tRP.
- x4/x8/x16 Package - including 16 support balls

## 2.0 Key Features

[ Table 2 ] 1Gb DDR3 C-die Speed bins

Speed	DDR3-800	DDR3-1066		DDR3-1333		Unit
	6-6-6	7-7-7	8-8-8	8-8-8	9-9-9	
tCK(min)	2.5	1.875		1.5		ns
CAS Latency	6	7	8	8	9	tCK
tRCD(min)	15	13.125	15	12	13.5	ns
tRP(min)	15	13.125	15	12	13.5	ns
tRAS(min)	37.5	37.5	37.5	36	36	ns
tRC(min)	52.5	50.625	52.5	48	49.5	ns

- JEDEC standard 1.5V ± 0.075V Power Supply
- VDDQ = 1.5V ± 0.075V
- 400 MHz f<sub>CK</sub> for 800Mb/sec/pin, 533MHz f<sub>CK</sub> for 1066Mb/sec/pin, 667MHz f<sub>CK</sub> for 1333Mb/sec/pin
- 8 Banks
- Posted CAS
- Programmable CAS Latency: 5, 6, 7, 8, 9, 10, (11 for high density only)
- Programmable Additive Latency: 0, CL-2 or CL-1 clock
- Programmable CAS Write Latency (CWL) = 5 (DDR3-800), 6 (DDR3-1066), 7 (DDR3-1333)
- 8-bit pre-fetch
- Burst Length: 8 (Interleave without any limit, sequential with starting address "000" only), 4 with tCCD = 4 which does not allow seamless read or write [either On the fly using A12 or MRS]
- Bi-directional Differential Data-Strobe
- Internal(self) calibration : Internal self calibration through ZQ pin (RZQ : 240 ohm ± 1%)
- On Die Termination using ODT pin
- Average Refresh Period 7.8us at lower than T<sub>CASE</sub> 85×C, 3.9us at 85×C < T<sub>CASE</sub> ≤ 95 ×C
- Asynchronous Reset
- Package : 94 balls FBGA - x4/x8 (with 16 support balls)  
112 balls FBGA - x16 (with 16 support balls)
- All of Lead-free products are compliant for RoHS

The 1Gb DDR3 SDRAM C-die is organized as a 32Mbit x 4/16Mbit x 8/8Mbit x 16 I/Os x 8banks device. This synchronous device achieves high speed double-data-rate transfer rates of up to 1333Mb/sec/pin (DDR3-1333) for general applications.

The chip is designed to comply with the following key DDR3 SDRAM features such as posted CAS, Programmable CWL, Internal (Self) Calibration, On Die Termination using ODT pin and Asynchronous Reset .

All of the control and address inputs are synchronized with a pair of externally supplied differential clocks. Inputs are latched at the crosspoint of differential clocks (CK rising and  $\overline{CK}$  falling). All I/Os are synchronized with a pair of bidirectional strobes (DQS and  $\overline{DQS}$ ) in a source synchronous fashion. The address bus is used to convey row, column, and bank address information in a  $\overline{RAS}/\overline{CAS}$  multiplexing style. The DDR3 device operates with a single 1.5V ± 0.075V power supply and 1.5V ± 0.075V VDDQ.

The 1Gb DDR3 device is available in 94ball FBGAs(x4/x8) and 112ball FBGA(x16)

Note : 1. The functionality described and the timing specifications included in this data sheet are for the DLL Enabled mode of operation.

2. 1066Mbps CL7 doesn't have back-ward compatibility with 800Mbps CL5

Note : This data sheet is an abstract of full DDR3 specification and does not cover the common features which are described in "DDR3 SDRAM Device Operation & Timing Diagram".

### 3.0 Package pinout/Mechanical Dimension & Addressing

#### 3.1 x4 Package Pinout (Top view) : 94ball FBGA Package(78balls + 16 balls of support balls)

	1	2	3	4	5	6	7	8	9	10	11	
A	NC	NC		NC				NC		NC	NC	
B												
C												
D	NC	VSS	VDD	NC				NC	VSS	VDD	NC	D
E		VSS	VSSQ	DQ0				DM	VSSQ	VDDQ		E
F		VDDQ	DQ2	DQS				DQ1	DQ3	VSSQ		F
G		VSSQ	NC	$\overline{DQS}$				VDD	VSS	VSSQ		G
H		VREFDQ	VDDQ	NC				NC	NC	VDDQ		H
J		NC	VSS	$\overline{RAS}$				CK	VSS	NC		J
K		ODT	VDD	$\overline{CAS}$				$\overline{CK}$	VDD	CKE		K
L		NC	$\overline{CS}$	$\overline{WE}$				A10/AP	ZQ	NC		L
M		VSS	BA0	BA2				A15	VREFCA	VSS		M
N		VDD	A3	A0				A12/ $\overline{BC}$	BA1	VDD		N
P		VSS	A5	A2				A1	A4	VSS		P
R		VDD	A7	A9				A11	A6	VDD		R
T	NC	VSS	$\overline{RESET}$	A13				NC	A8	VSS	NC	T
U												
V												
W	NC	NC		NC				NC		NC	NC	

Note1: A1,A2,A4,A8,A10,A11,D1,D11,T1,T11,W1,W2,W4,W8,W10 and W11 balls indicate mechanical support balls with no internal connection

#### Ball Locations (x4)

- Populated ball
- + Ball not populated

Top view  
(See the balls through the Package)

	1	2	3	4	5	6	7	8	9	10	11
A	●	●	+	●	+	+	+	●	+	●	●
B	+	+	+	+	+	+	+	+	+	+	+
C	+	+	+	+	+	+	+	+	+	+	+
D	●	●	●	●	+	+	+	●	●	●	●
E	+	●	●	●	+	+	+	●	●	●	+
F	+	●	●	●	+	+	+	●	●	●	+
G	+	●	●	●	+	+	+	●	●	●	+
H	+	●	●	●	+	+	+	●	●	●	+
J	+	●	●	●	+	+	+	●	●	●	+
K	+	●	●	●	+	+	+	●	●	●	+
L	+	●	●	●	+	+	+	●	●	●	+
M	+	●	●	●	+	+	+	●	●	●	+
N	+	●	●	●	+	+	+	●	●	●	+
P	+	●	●	●	+	+	+	●	●	●	+
R	+	●	●	●	+	+	+	●	●	●	+
T	●	●	●	●	+	+	+	●	●	●	●
U	+	+	+	+	+	+	+	+	+	+	+
V	+	+	+	+	+	+	+	+	+	+	+
W	●	●	+	●	+	+	+	●	+	●	●

3.2 x8 Package Pinout (Top view) : 94ball FBGA Package(78balls + 16 balls of support balls)

	1	2	3	4	5	6	7	8	9	10	11	
A	NC	NC		NC				NC		NC	NC	
B												
C												
D	NC	VSS	VDD	NC				NU/TDQS	VSS	VDD	NC	D
E		VSS	VSSQ	DQ0				DM/TDQS	VSSQ	VDDQ		E
F		VDDQ	DQ2	DQS				DQ1	DQ3	VSSQ		F
G		VSSQ	DQ6	DQS				VDD	VSS	VSSQ		G
H		VREFDQ	VDDQ	DQ4				DQ7	DQ5	VDDQ		H
J		NC	VSS	RAS				CK	VSS	NC		J
K		ODT	VDD	CAS				CK	VDD	CKE		K
L		NC	CS	WE				A10/AP	ZQ	NC		L
M		VSS	BA0	BA2				NC	VREFCA	VSS		M
N		VDD	A3	A0				A12/BC	BA1	VDD		N
P		VSS	A5	A2				A1	A4	VSS		P
R		VDD	A7	A9				A11	A6	VDD		R
T	NC	VSS	RESET	A13				NC	A8	VSS	NC	T
U												
V												
W	NC	NC		NC				NC		NC	NC	

Note1: A1,A2,A4,A8,A10,A11,D1,D11,T1,T11,W1,W2,W4,W8,W10 and W11 balls indicate mechanical support balls with no internal connection

Ball Locations (x8)

- Populated ball
- + Ball not populated

Top view  
(See the balls through the Package)

	1	2	3	4	5	6	7	8	9	10	11
A	●	●	+	●	+	+	+	●	+	●	●
B	+	+	+	+	+	+	+	+	+	+	+
C	+	+	+	+	+	+	+	+	+	+	+
D	●	●	●	●	+	+	+	●	●	●	●
E	+	●	●	●	+	+	+	●	●	●	+
F	+	●	●	●	+	+	+	●	●	●	+
G	+	●	●	●	+	+	+	●	●	●	+
H	+	●	●	●	+	+	+	●	●	●	+
J	+	●	●	●	+	+	+	●	●	●	+
K	+	●	●	●	+	+	+	●	●	●	+
L	+	●	●	●	+	+	+	●	●	●	+
M	+	●	●	●	+	+	+	●	●	●	+
N	+	●	●	●	+	+	+	●	●	●	+
P	+	●	●	●	+	+	+	●	●	●	+
R	+	●	●	●	+	+	+	●	●	●	+
T	●	●	●	●	+	+	+	●	●	●	●
U	+	+	+	+	+	+	+	+	+	+	+
V	+	+	+	+	+	+	+	+	+	+	+
W	●	●	+	●	+	+	+	●	+	●	●

3.3 x16 Package Pinout (Top view) : 112ball FBGA Package(96balls + 16 balls of support balls)

	1	2	3	4	5	6	7	8	9	10	11	
A	NC	NC		NC				NC		NC	NC	
B												
C												
D	NC	VDDQ	DQU5	DQU7				DQU4	VDDQ	VSS	NC	D
E		VSSQ	VDD	VSS				DQSU	DQU6	VSSQ		E
F		VDDQ	DQU3	DQU1				DQSU	DQU2	VDDQ		F
G		VSSQ	VDDQ	DMU				DQU0	VSSQ	VDD		G
H		VSS	VSSQ	DQL0				DML	VSSQ	VDDQ		H
J		VDDQ	DQL2	DQSL				DQL1	DQL3	VSSQ		J
K		VSSQ	DQL6	DQSL				VDD	VSS	VSSQ		K
L		VREFDQ	VDDQ	DQL4				DQL7	DQL5	VDDQ		L
M		NC	VSS	RAS				CK	VSS	NC		M
N		ODT	VDD	CAS				CK	VDD	CKE		N
P		NC	CS	WE				A10/AP	ZQ	NC		P
R		VSS	BA0	BA2				A15	VREFCA	VSS		R
T		VDD	A3	A0				A12/BC	BA1	VDD		T
U		VSS	A5	A2				A1	A4	VSS		U
V		VDD	A7	A9				A11	A6	VDD		V
W	NC	VSS	RESET	A13				NC	A8	VSS	NC	W
Y												
AA												
AB	NC	NC		NC				NC		NC	NC	

Note1: A1,A2,A4,A8,A10,A11,D1,D11,W1,W11,AB1,AB2,AB4,AB8,AB10 and AB11 balls indicate mechanical support balls with no internal connection

Ball Locations (x16)

- Populated ball
- + Ball not populated

Top view  
(See the balls through the Package)

	1	2	3	4	5	6	7	8	9	10	11
A	●	●	+	●	+	+	+	●	+	●	●
B	+	+	+	+	+	+	+	+	+	+	+
C	+	+	+	+	+	+	+	+	+	+	+
D	●	●	●	+	+	+	●	●	●	●	●
E	+	●	●	●	+	+	+	●	●	●	+
F	+	●	●	●	+	+	+	●	●	●	+
G	+	●	●	●	+	+	+	●	●	●	+
H	+	●	●	●	+	+	+	●	●	●	+
J	+	●	●	●	+	+	+	●	●	●	+
K	+	●	●	●	+	+	+	●	●	●	+
L	+	●	●	●	+	+	+	●	●	●	+
M	+	●	●	●	+	+	+	●	●	●	+
N	+	●	●	●	+	+	+	●	●	●	+
P	+	●	●	●	+	+	+	●	●	●	+
R	+	●	●	●	+	+	+	●	●	●	+
T	+	●	●	●	+	+	+	●	●	●	+
U	+	●	●	●	+	+	+	●	●	●	+
V	+	●	●	●	+	+	+	●	●	●	+
W	●	●	●	●	+	+	+	●	●	●	●
Y	+	+	+	+	+	+	+	+	+	+	+
AA	+	+	+	+	+	+	+	+	+	+	+
AB	●	●	+	●	+	+	+	●	+	●	●

3.4 FBGA Package Dimension (x4)

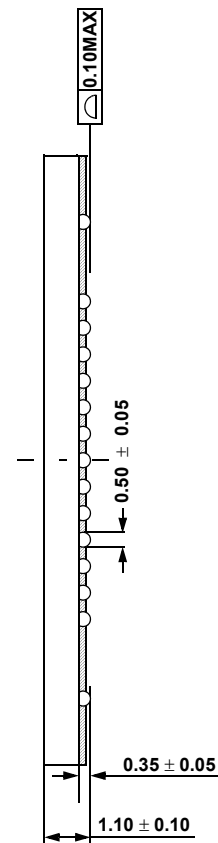
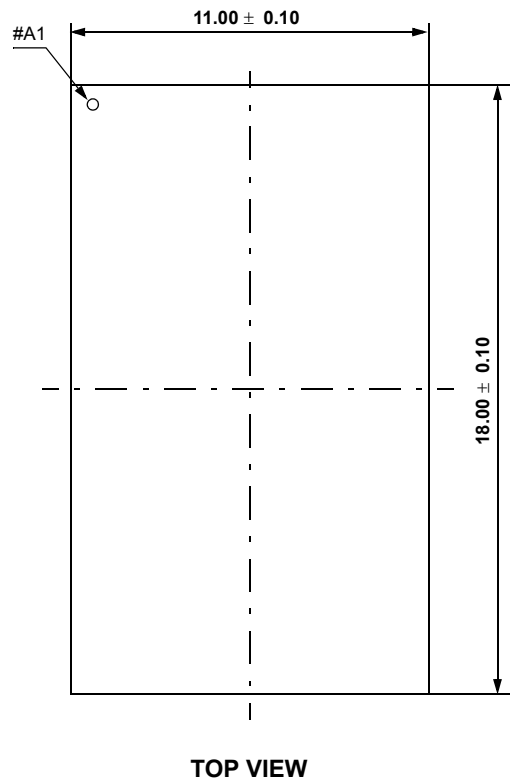
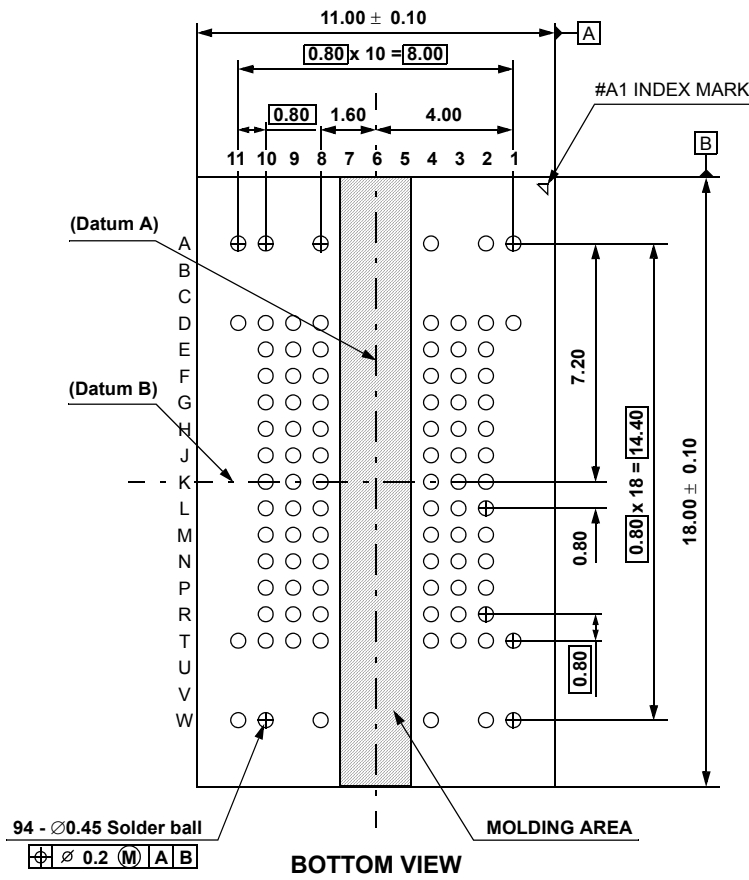



3.5 FBGA Package Dimension (x8)

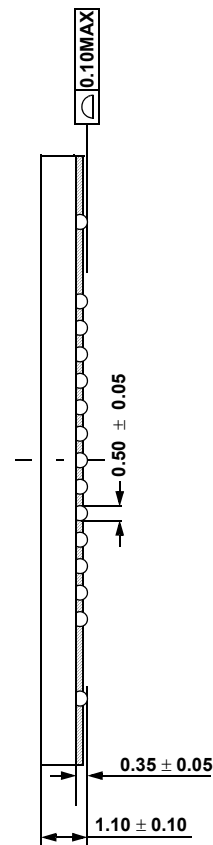
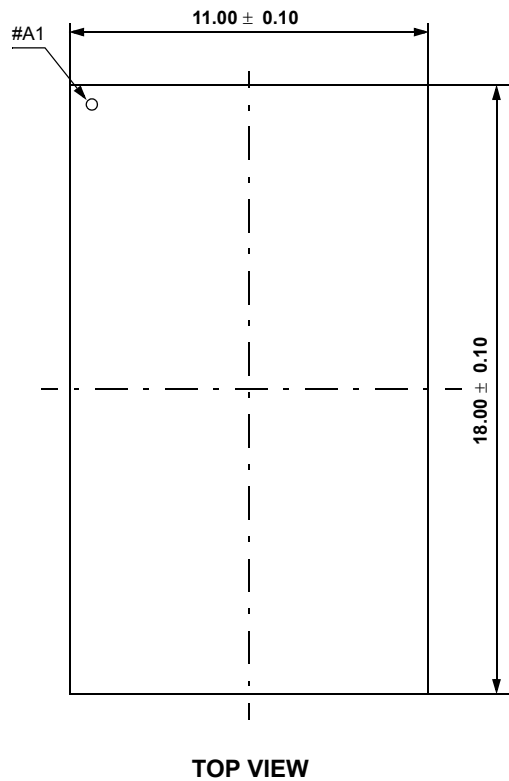
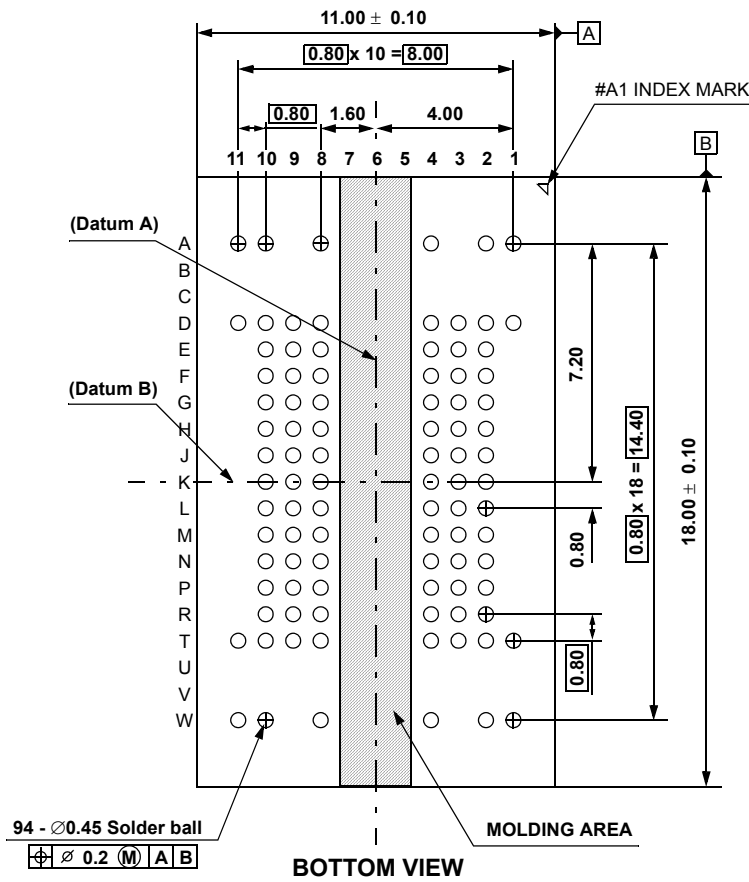

3.6 FBGA Package Dimension (x16)

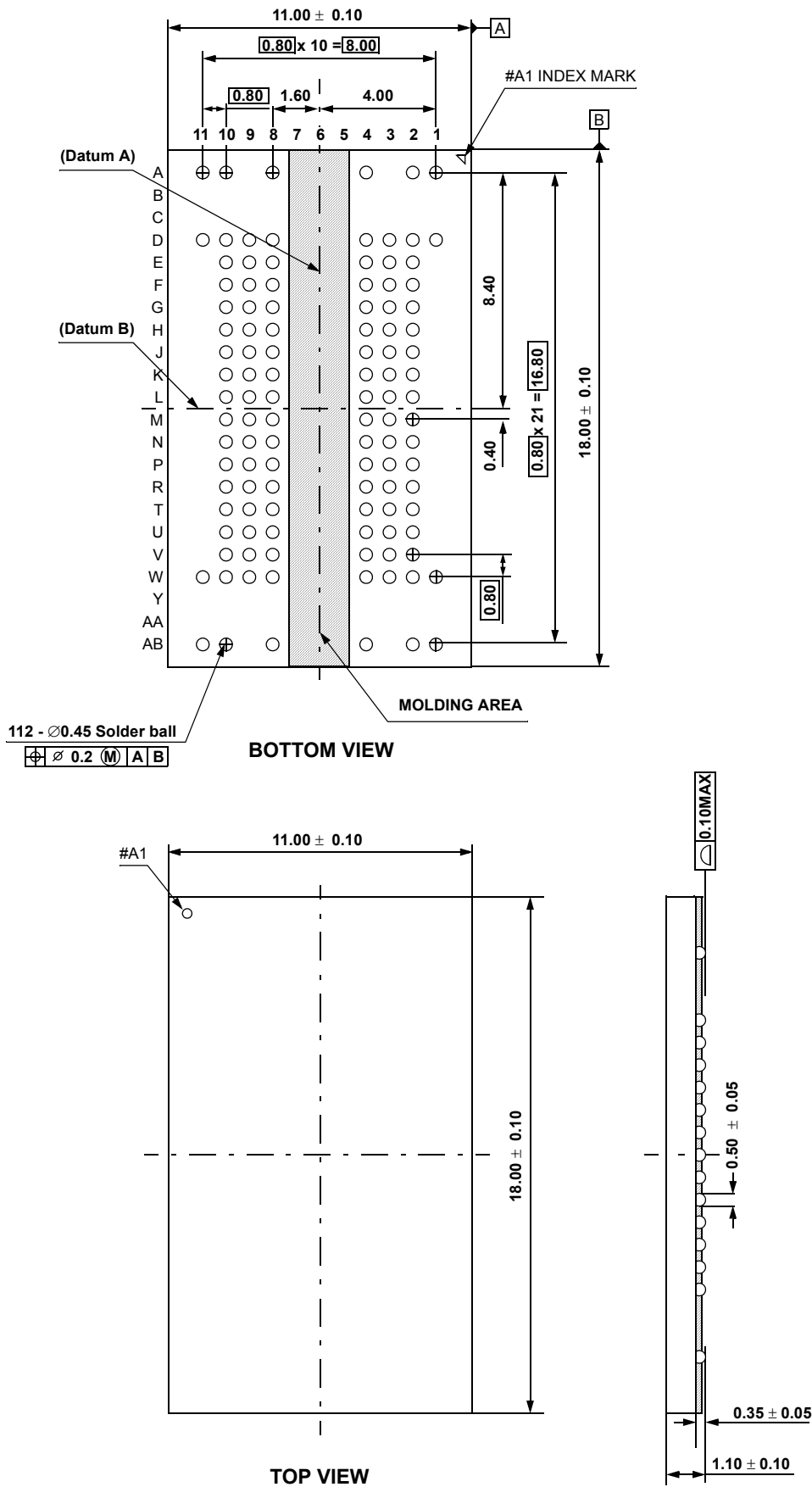

## 4.0 Input/Output Functional Description

[ Table 3 ] Input/Output function description

Symbol	Type	Function
CK, $\overline{CK}$	Input	<b>Clock:</b> CK and $\overline{CK}$ are differential clock inputs. All address and control input signals are sampled on the crossing of the positive edge of CK and negative edge of $\overline{CK}$ . Output (read) data is referenced to the crossings of CK and $\overline{CK}$ .
CKE	Input	<b>Clock Enable:</b> CKE HIGH activates, and CKE Low deactivates, internal clock signals and device input buffers and output drivers. Taking CKE Low provides Precharge Power-Down and Self Refresh operation (all banks idle), or Active Power-Down (Row Active in any bank). CKE is asynchronous for self refresh exit. After VREFCA has become stable during the power on and initialization sequence, it must be maintained during all operations (including Self-Refresh). CKE must be maintained high throughout read and write accesses. Input buffers, excluding CK, $\overline{CK}$ , ODT and CKE are disabled during power-down. Input buffers, excluding CKE, are disabled during Self-Refresh.
$\overline{CS}$	Input	<b>Chip Select:</b> All commands are masked when $\overline{CS}$ is registered HIGH. $\overline{CS}$ provides for external Rank selection on systems with multiple Ranks. $\overline{CS}$ is considered part of the command code.
ODT	Input	<b>On Die Termination:</b> ODT (registered HIGH) enables termination resistance internal to the DDR3 SDRAM. When enabled, ODT is only applied to each DQ, DQS, DQS and DM/TDQS, NU/TDQS (When TDQS is enabled via Mode Register A11=1 in MR1) signal for x8 configurations. The ODT pin will be ignored if the Mode Register (MR1) is programmed to disable ODT.
$\overline{RAS}$ , $\overline{CAS}$ , $\overline{WE}$	Input	<b>Command Inputs:</b> $\overline{RAS}$ , $\overline{CAS}$ and $\overline{WE}$ (along with $\overline{CS}$ ) define the command being entered.
DM (DMU), (DML)	Input	<b>Input Data Mask:</b> DM is an input mask signal for write data. Input data is masked when DM is sampled HIGH coincident with that input data during a Write access. DM is sampled on both edges of DQS. For x8 device, the function of DM or TDQS/ $\overline{TDQS}$ is enabled by Mode Register A11 setting in MR1.
BA0 - BA2	Input	<b>Bank Address Inputs:</b> BA0 - BA2 define to which bank an Active, Read, Write or Precharge command is being applied. Bank address also determines if the mode register or extended mode register is to be accessed during a MRS cycle.
A0 - A12	Input	<b>Address Inputs:</b> Provided the row address for Active commands and the column address for Read/Write commands to select one location out of the memory array in the respective bank. (A10/AP and A12/ $\overline{BC}$ have additional functions, see below) The address inputs also provide the op-code during Mode Register Set commands.
A10 / AP	Input	<b>Autoprecharge:</b> A10 is sampled during Read/Write commands to determine whether Autoprecharge should be performed to the accessed bank after the Read/Write operation. (HIGH:Autoprecharge; LOW: No Autoprecharge) A10 is sampled during a Precharge command to determine whether the Precharge applies to one bank (A10 LOW) or all banks (A10 HIGH). if only one bank is to be precharged, the bank is selected by bank addresses.
A12 / $\overline{BC}$	Input	<b>Burst Chop:</b> A12 is sampled during Read and Write commands to determine if burst chop(on-the-fly) will be performed. (HIGH : no burst chop, LOW : burst chopped). See command truth table for details
$\overline{RESET}$	Input	<b>Active Low Asynchronous Reset:</b> Reset is active when $\overline{RESET}$ is LOW, and inactive when $\overline{RESET}$ is HIGH. $\overline{RESET}$ must be HIGH during normal operation. $\overline{RESET}$ is a CMOS rail to rail signal with DC high and low at 80% and 20% of VDD, i.e. 1.20V for DC high and 0.30V for DC low.
DQ	Input/Output	<b>Data Input/ Output:</b> Bi-directional data bus.
DQS, ( $\overline{DQS}$ )	Input/Output	<b>Data Strobe:</b> output with read data, input with write data. Edge-aligned with read data, centered in write data.
TDQS, ( $\overline{TDQS}$ )	Output	<b>Termination Data Strobe:</b> TDQS/ $\overline{TDQS}$ is applicable for X8 DRAMs only. When enabled via Mode Register A11=1 in MR1, DRAM will enable the same termination resistance function on TDQS/ $\overline{TDQS}$ that is applied to DQS/DQS. When disabled via mode register A11=0 in MR1, DM/TDQS will provide the data mask function and TDQS is not used.
NC		<b>No Connect:</b> No internal electrical connection is present.
V <sub>DDQ</sub>	Supply	<b>DQ Power Supply:</b> 1.5V +/- 0.075V
V <sub>SSQ</sub>	Supply	<b>DQ Ground</b>
V <sub>DD</sub>	Supply	<b>Power Supply:</b> 1.5V +/- 0.075V
V <sub>SS</sub>	Supply	<b>Ground</b>
V <sub>REFDQ</sub>	Supply	<b>Reference voltage for DQ</b>
V <sub>REFCA</sub>	Supply	<b>Reference voltage for CA</b>
ZQ	Supply	<b>Reference Pin for ZQ calibration</b>

Note : Input only pins (BA0-BA2, A0-A12,  $\overline{RAS}$ ,  $\overline{CAS}$ ,  $\overline{WE}$ ,  $\overline{CS}$ , CKE, ODT and  $\overline{RESET}$ ) do not supply termination.

## 5.0 DDR3 SDRAM Addressing

## 512Mb

Configuration	128Mb x4	64Mb x 8	32Mb x16
# of Bank	8	8	8
Bank Address	BA0 - BA2	BA0 - BA2	BA0 - BA2
Auto precharge	A <sub>10</sub> /AP	A <sub>10</sub> /AP	A <sub>10</sub> /AP
Row Address	A <sub>0</sub> - A <sub>12</sub>	A <sub>0</sub> - A <sub>12</sub>	A <sub>0</sub> - A <sub>11</sub>
Column Address	A <sub>0</sub> - A <sub>9</sub> ,A <sub>11</sub>	A <sub>0</sub> - A <sub>9</sub>	A <sub>0</sub> - A <sub>9</sub>
BC switch on the fly	A <sub>12</sub> /BC	A <sub>12</sub> /BC	A <sub>12</sub> /BC
Page size *1	1 KB	1 KB	2 KB

\* Reference Information : The following tables are address mapping information for other densities

## 1Gb

Configuration	256Mb x4	128Mb x 8	64Mb x16
# of Bank	8	8	8
Bank Address	BA0 - BA2	BA0 - BA2	BA0 - BA2
Auto precharge	A <sub>10</sub> /AP	A <sub>10</sub> /AP	A <sub>10</sub> /AP
Row Address	A <sub>0</sub> - A <sub>13</sub>	A <sub>0</sub> - A <sub>13</sub>	A <sub>0</sub> - A <sub>12</sub>
Column Address	A <sub>0</sub> - A <sub>9</sub> ,A <sub>11</sub>	A <sub>0</sub> - A <sub>9</sub>	A <sub>0</sub> - A <sub>9</sub>
BC switch on the fly	A <sub>12</sub> /BC	A <sub>12</sub> /BC	A <sub>12</sub> /BC
Page size *1	1 KB	1 KB	2 KB

## 2Gb

Configuration	512Mb x4	256Mb x 8	128Mb x16
# of Bank	8	8	8
Bank Address	BA <sub>0</sub> - BA <sub>2</sub>	BA <sub>0</sub> - BA <sub>2</sub>	BA <sub>0</sub> - BA <sub>2</sub>
Auto precharge	A <sub>10</sub> /AP	A <sub>10</sub> /AP	A <sub>10</sub> /AP
Row Address	A <sub>0</sub> - A <sub>14</sub>	A <sub>0</sub> - A <sub>14</sub>	A <sub>0</sub> - A <sub>13</sub>
Column Address	A <sub>0</sub> - A <sub>9</sub> ,A <sub>11</sub>	A <sub>0</sub> - A <sub>9</sub>	A <sub>0</sub> - A <sub>9</sub>
BC switch on the fly	A <sub>12</sub> /BC	A <sub>12</sub> /BC	A <sub>12</sub> /BC
Page size	1 KB	1 KB	2 KB

## 4Gb

Configuration	1Gb x4	512Mb x 8	256Mb x16
# of Bank	8	8	8
Bank Address	BA <sub>0</sub> - BA <sub>2</sub>	BA <sub>0</sub> - BA <sub>2</sub>	BA <sub>0</sub> - BA <sub>2</sub>
Auto precharge	A <sub>10</sub> /AP	A <sub>10</sub> /AP	A <sub>10</sub> /AP
Row Address	A <sub>0</sub> - A <sub>15</sub>	A <sub>0</sub> - A <sub>15</sub>	A <sub>0</sub> - A <sub>14</sub>
Column Address	A <sub>0</sub> - A <sub>9</sub> ,A <sub>11</sub>	A <sub>0</sub> - A <sub>9</sub>	A <sub>0</sub> - A <sub>9</sub>
BC switch on the fly	A <sub>12</sub> /BC	A <sub>12</sub> /BC	A <sub>12</sub> /BC
Page size	1 KB	1 KB	2 KB

## 8Gb

Configuration	2Gb x4	1Gb x 8	512Mb x16
# of Bank	8	8	8
Bank Address	BA0 - BA2	BA0 - BA2	BA0 - BA2
Auto precharge	A10/AP	A10/AP	A10/AP
Row Address	A0 - A15	A0 - A15	A0 - A15
Column Address	A0 - A9,A11,A13	A0 - A9,A11	A0 - A9
BC switch on the fly	A12/ $\overline{BC}$	A12/ $\overline{BC}$	A12/ $\overline{BC}$
Page size	2 KB	2 KB	2 KB

Note 1 : Page size is the number of bytes of data delivered from the array to the internal sense amplifiers when an ACTIVE command is registered.

Page size is per bank, calculated as follows:  $\text{page size} = 2^{\text{COLBITS}} * \text{ORG} \approx 8$

where, COLBITS = the number of column address bits, ORG = the number of I/O (DQ) bits

## 6.0 Absolute Maximum Ratings

### 6.1 Absolute Maximum DC Ratings

Symbol	Parameter	Rating	Units	Notes
VDD	Voltage on VDD pin relative to Vss	-0.4 V ~ 1.975 V	V	1,3
VDDQ	Voltage on VDDQ pin relative to Vss	-0.4 V ~ 1.975 V	V	1,3
V <sub>IN</sub> , V <sub>OUT</sub>	Voltage on any pin relative to Vss	-0.4 V ~ 1.975 V	V	1
T <sub>STG</sub>	Storage Temperature	-55 to +100	°C	

[ Table 4 ] Absolute Maximum DC Ratings

Note :

- Stresses greater than those listed under "Absolute Maximum Ratings" may cause permanent damage to the device. This is a stress rating only and functional operation of the device at these or any other conditions above those indicated in the operational sections of this specification is not implied. Exposure to absolute maximum rating conditions for extended periods may affect reliability.
- Storage Temperature is the case surface temperature on the center/top side of the DRAM. For the measurement conditions, please refer to JESD51-2 standard.
- VDD and VDDQ must be within 300mV of each other at all times; and VREF must be not greater than 0.6xVDDQ, When VDD and VDDQ are less than 500mV; VREF may be equal to or less than 300mV.

### 6.2 DRAM Component Operating Temperature Range

Symbol	Parameter	rating	Unit	Notes
T <sub>OPER</sub>	Normal Operating Temperature Range	0 to 85	°C	1,2
	Extended Temperature Range (Optional)	85 to 95	°C	1,3

[ Table 5 ] Temperature Range

Note :

- Operating Temperature T<sub>OPER</sub> is the case surface temperature on the center/top side of the DRAM. For measurement conditions, please refer to the JEDEC document JESD51-2.
- The Normal Temperature Range specifies the temperatures where all DRAM specifications will be supported. During operation, the DRAM case temperature must be maintained between 0-85°C under all operating conditions
- Some applications require operation of the Extended Temperature Range between 85°C and 95°C case temperature. Full specifications are guaranteed in this range, but the following additional conditions apply:
  - Refresh commands must be doubled in frequency, therefore reducing the Refresh interval tREFI to 3.9us. It is also possible to specify a component with 1X refresh (tREFI to 7.8us) in the Extended Temperature Range. Please refer to supplier data sheet and/or the DIMM SPD for option availability.
  - If Self-Refresh operation is required in the Extended Temperature Range, then it is mandatory to either use the Manual Self-Refresh mode with Extended Temperature Range capability (MR2 A6 = 0b and MR2 A7 = 1b) or enable the optional Auto Self-Refresh mode (MR2 A6 = 1b and MR2 A7 = 0b). Please refer to the supplier data sheet and/or the DIMM SPD for Auto Self-Refresh option availability, Extended Temperature Range support and tREFI requirements in the Extended Temperature Range.

## 7.0 AC & DC Operating Conditions

### 7.1 Recommended DC operating Conditions (SSTL\_1.5)

Symbol	Parameter	Rating			Units	Notes
		Min.	Typ.	Max.		
VDD	Supply Voltage	1.425	1.5	1.575	V	1,2
VDDQ	Supply Voltage for Output	1.425	1.5	1.575	V	1,2

[ Table 6 ] Recommended DC Operating Conditions

Note :

- Under all conditions VDDQ must be less than or equal to VDD.
- VDDQ tracks with VDD. AC parameters are measured with VDD and VDDQ tied together.

## 8.0 AC & DC Input Measurement Levels

### 8.1 AC and DC Logic input levels for single-ended signals

Symbol	Parameter	DDR3-800/1066/1333		Unit	Notes
		Min.	Max.		
$V_{IH}(DC)$	dc input logic high	$V_{REF} + 100$	VDD	mV	1
$V_{IL}(DC)$	dc input logic low	VSS	$V_{REF} - 100$	mV	1
$V_{IH}(AC)$	ac input logic high	$V_{REF} + 175$	-	mV	1,2
$V_{IL}(AC)$	ac input logic low	-	$V_{REF} - 175$	mV	1,2
$V_{REFDQ}(DC)$	I/O Reference Voltage(DQ)	$0.49 \cdot V_{DDQ}$	$0.51 \cdot V_{DDQ}$	V	3,4
$V_{REFCA}(DC)$	I/O Reference Voltage(CMD/ADD)	$0.49 \cdot V_{DDQ}$	$0.51 \cdot V_{DDQ}$	V	3,4

[ Table 7 ] Single Ended AC and DC input levels

Note :

- For DQ and DM,  $V_{REF} = V_{REFDQ}$ . For input only pins except RESET, or  $V_{REF} = V_{REFCA}$
- See 9.6 "Overshoot and Undershoot specifications" on page 23.
- The ac peak noise on  $V_{REF}$  may not allow  $V_{REF}$  to deviate from  $V_{REF(DC)}$  by more than  $\pm 1\%$  VDD (for reference : approx.  $\pm 15mV$ )
- For reference : approx.  $V_{DD}/2 \pm 15mV$

The dc-tolerance limits and ac-noise limits for the reference voltages  $V_{REFCA}$  and  $V_{REFDQ}$  are illustrate in Figure 1. It shows a valid reference voltage  $V_{REF}(t)$  as a function of time. ( $V_{REF}$  stands for  $V_{REFCA}$  and  $V_{REFDQ}$  likewise).

$V_{REF}(DC)$  is the linear average of  $V_{REF}(t)$  over a very long period of time (e.g. 1 sec). This average has to meet the min/max requirements in above table. Furthermore  $V_{REF}(t)$  may temporarily deviate from  $V_{REF}(DC)$  by no more than  $\pm 1\%$  VDD.

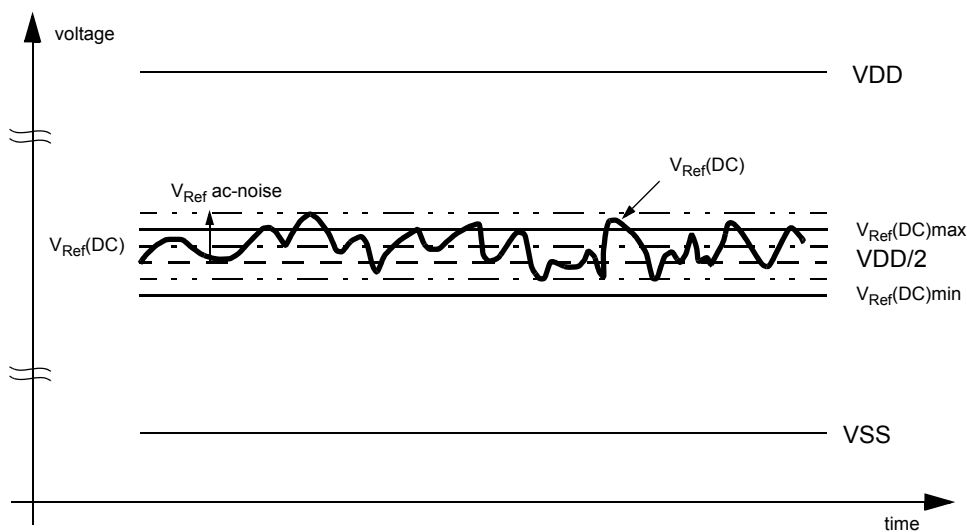

Figure 1. Illustration of  $V_{REF}(DC)$  tolerance and  $V_{REF}$  ac-noise limits

The voltage levels for setup and hold time measurements  $V_{IH}(AC)$ ,  $V_{IH}(DC)$ ,  $V_{IL}(AC)$  and  $V_{IL}(DC)$  are dependent on  $V_{REF}$ .

" $V_{REF}$ " shall be understood as  $V_{REF}(DC)$ , as defined in Figure 1.

This clarifies, that dc-variations of  $V_{REF}$  affect the absolute voltage a signal has to reach to achieve a valid high or low level and therefore the time to which setup and hold is measured. System timing and voltage budgets need to account for  $V_{REF}(DC)$  deviations from the optimum position within the data-eye of the input signals.

This also clarifies that the DRAM setup/hold specification and derating values need to include time and voltage associated with  $V_{REF}$  ac-noise. Timing and voltage effects due to ac-noise on  $V_{REF}$  up to the specified limit ( $\pm 1\%$  of VDD) are included in DRAM timings and their associated deratings.

8.2 Differential swing requirement for differential signals

Figure 2 : Definition of differential ac-swing and "time above ac level tDVAC

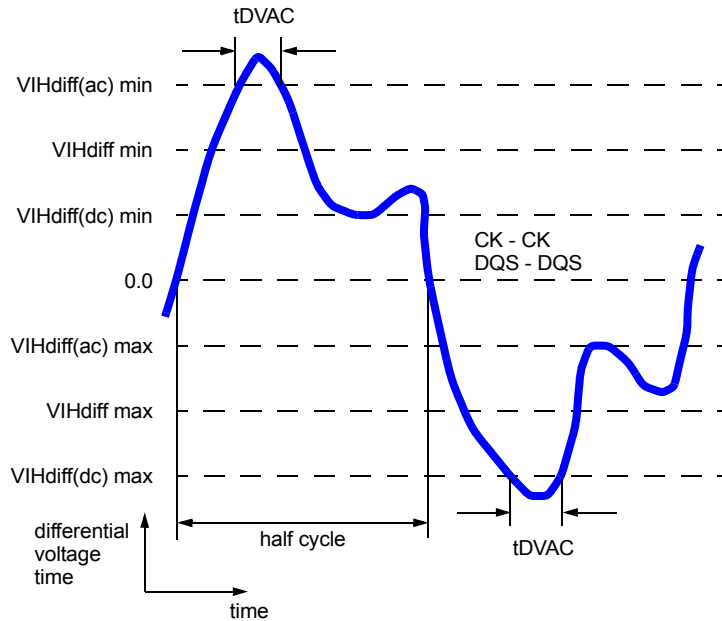

[ Table 8 ] Differential swing requirement for clock (CK -  $\overline{CK}$ ) and strobe (DQS -  $\overline{DQS}$ )

Symbol	Parameter	DDR3-800 & 1066 & 1033 & 1600		unit	Note
		min	max		
VIHdiff	differential input high	+0.2	note 3	V	1
VILdiff	differential input low	note 3	-0.2	V	1
VIHdiff(ac)	differential input high ac	2 x (VIH(ac)-Vref)	note 3	V	2
VILdiff(ac)	differential input low ac	note 3	2 x (Vref - VIL(ac))	V	2

Notes:

- used to define a differential signal slew-rate.
- for CK -  $\overline{CK}$  use VIH/VIL(ac) of ADD/CMD and VREFCA; for DQS -  $\overline{DQS}$ , DQSL -  $\overline{DQSL}$ , DQSU -  $\overline{DQSU}$  use VIH/VIL(ac) of DQs and VREFDQ; if a reduced ac-high or ac-low level is used for a signal group, then the reduced level applies also here.
- these values are not defined, however they single-ended signals CK,  $\overline{CK}$ , DQS,  $\overline{DQS}$ , DQSL,  $\overline{DQSL}$ , DQSU,  $\overline{DQSU}$  need to be within the respective limits (VIH(dc) max, VIL(dc)min) for single-ended signals as well as the limitations for overshoot and undershoot.

[ Table 9 ] Allowed time before ringback (tDVAC) for CLK -  $\overline{CLK}$  and DQS -  $\overline{DQS}$ .

Slew Rate [V/ns]	tDVAC [ps] @  VIH/Ldiff(ac)  = 350mV		tDVAC [ps] @  VIH/Ldiff(ac)  = 300mV	
	min	max	min	max
> 4.0	75	-	175	-
4.0	57	-	170	-
3.0	50	-	167	-
2.0	38	-	163	-
1.8	34	-	162	-
1.6	29	-	161	-
1.4	22	-	159	-
1.2	13	-	155	-
1.0	0	-	150	-
< 1.0	0	-	150	-



### 8.2.1 Single-ended requirements for differential signals

Each individual component of a differential signal (CK, DQS, DQSL, DQSU,  $\overline{\text{CK}}$ ,  $\overline{\text{DQS}}$ ,  $\overline{\text{DQSL}}$ , or  $\overline{\text{DQSU}}$ ) has also to comply with certain requirements for single-ended signals.

CK and  $\overline{\text{CK}}$  have to approximately reach VSEHmin / VSELmax (approximately equal to the ac-levels (  $V_{IH}(ac)$  /  $V_{IL}(ac)$  ) for ADD/CMD signals) in every half-cycle.

DQS, DQSL, DQSU,  $\overline{\text{DQS}}$ ,  $\overline{\text{DQSL}}$  have to reach VSEHmin / VSELmax (approximately the ac-levels (  $V_{IH}(ac)$  /  $V_{IL}(ac)$  ) for DQ signals) in every half-cycle preceding and following a valid transition.

Note that the applicable ac-levels for ADD/CMD and DQ's might be different per speed-bin etc. E.g. if  $V_{IH150}(ac)/V_{IL150}(ac)$  is used for ADD/CMD signals, then these ac-levels apply also for the single-ended signals CK and  $\overline{\text{CK}}$

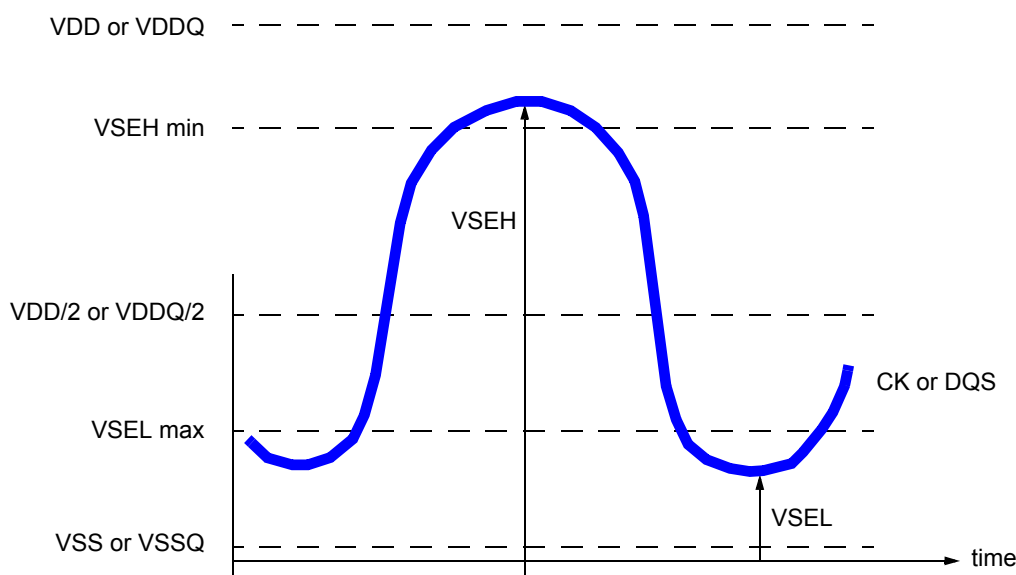

Figure 3: Single-ended requirement for differential signals.

Note that while ADD/CMD and DQ signal requirements are with respect to  $V_{ref}$ , the single-ended components of differential signals have a requirement with respect to  $V_{DD}/2$ ; this is nominally the same. The transition of single-ended signals through the ac-levels is used to measure setup time. For single-ended components of differential signals the requirement to reach VSELmax, VSEHmin has no bearing on timing, but adds a restriction on the common mode characteristics of these signals.

8.3 AC and DC logic input levels for Differential Signals

[ Table 10 ] Differential DC and AC input levels

Symbol	Parameter	DDR3-800/1066/1333		Unit	Notes
		Min	Max		
V <sub>IHdiff</sub>	Differential input logic high	+ 200	-	mV	1
V <sub>ILdiff</sub>	Differential input logic low	-	- 200		

Note :

1. Refer to "Overshoot and Undershoot specifications" on page 23.

8.4 Differential Input Cross Point Voltage

To guarantee tight setup and hold times as well as output skew parameters with respect to clock and strobe, each cross point voltage of differential input signals (CK,  $\overline{CK}$  and DQS,  $\overline{DQS}$ ) must meet the requirements in below table. The differential input cross point voltage V<sub>Ix</sub> is measured from the actual cross point of true and complement signal to the midlevel between of VDD and VSS.

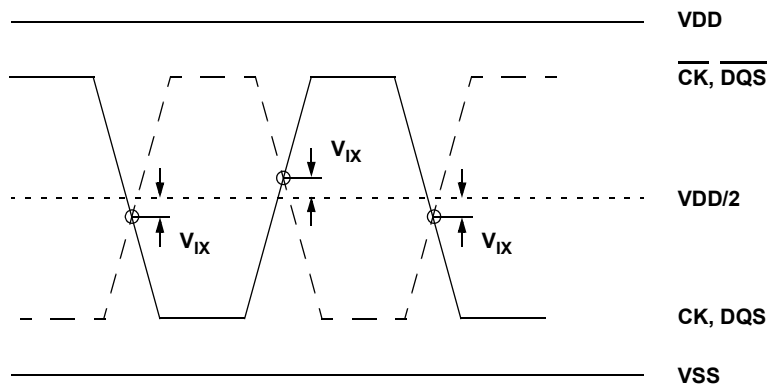

Figure 4. Vix Definition

[ Table 11 ] Cross point voltage for differential input signals (CK, DQS)

Symbol	Parameter	DDR3-800/1066/1333/1600		Unit	Notes
		Min	Max		
V <sub>Ix</sub>	Differential input Cross point voltage relative to VDD/2	-150	150	mV	

8.5 Slew rate definition for Single Ended Input Signals

8.5.1 Input Slew Rate for Input Setup Time (tIS) and Data Setup Time (tDS)

Setup (tIS and tDS) nominal slew rate for a rising signal is defined as the slew rate between the last crossing of Vref and the first crossing of VIH(AC)min. Setup (tIS and tDS) nominal slew rate for a falling signal is defined as the slew rate between the last crossing of Vref and the first crossing of VIL(AC)max.

8.5.2 Input Slew Rate for Input Hold Time (tIH) and Data Hold Time (tDH)

Hold nominal slew rate for a rising signal is defined as the slew rate between the last crossing of VIL(DC)max and the first crossing of Vref. Hold (tIH & tDH) nominal slew rate for a falling signal is defined as the slew rate between the last crossing of VIH(DC)min and the first crossing of Vref

Description	Measured		Defined by	Applicable for
	From	To		
Input slew rate for rising edge	Vref	VIH(AC)min	$\frac{VIH(AC)min - Vref}{\Delta TRS}$	Setup (tIS, tDS)
Input slew rate for falling edge	Vref	VIL(AC)max	$\frac{Vref - VIL(AC)max}{\Delta TFS}$	
Input slew rate for rising edge	VIL(DC)max	Vref	$\frac{Vref - VIL(DC)max}{\Delta TFH}$	Hold (tIH, tDH)
Input slew rate for falling edge	VIH(DC)min	Vref	$\frac{VIH(DC)min - Vref}{\Delta TRH}$	

[ Table 12 ] Single Ended Input Slew Rate definition

Notes: This nominal slew rate applies for linear signal waveforms.

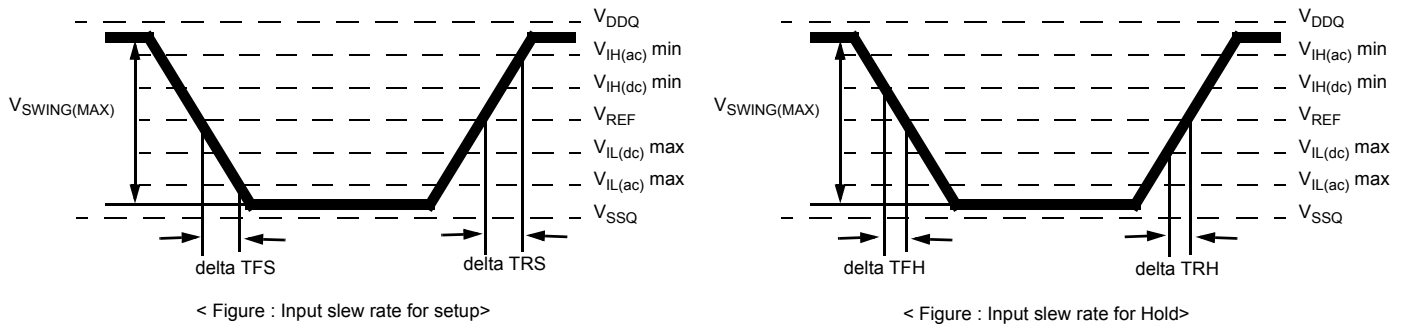

Figure 5. Input Nominal Slew Rate definition for Singel ended Signals

8.6 Slew rate definition for Differential Input Signals

Description	Measured		Defined by
	From	To	
Differential input slew rate for rising edge (CK-CK and DQS-DQS)	VILdiffmax	VIHdiffmin	$\frac{VIHdiffmin - VILdiffmax}{\Delta TRdiff}$
Differential input slew rate for falling edge (CK-CK and DQS-DQS)	VIHdiffmin	VILdiffmax	$\frac{VIHdiffmin - VILdiffmax}{\Delta TFdiff}$

[ Table 13 ] Differential input slew rate definition

Note : The differential signal (i.e. CK - CK and DQS - DQS) must be linear between these thresholds

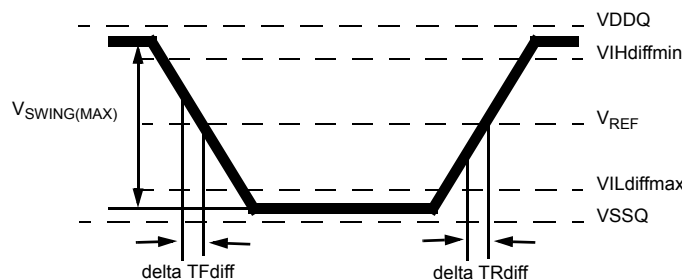

Figure 6. Differential Input Slew Rate definition for DQS, DQS and CK, CK

## 9.0 AC and DC Output Measurement Levels

### 9.1 Single Ended AC and DC Output Levels

[ Table 14 ] Single Ended AC and DC output levels

Symbol	Parameter	DDR3-800/1066/1333/1600	Units	Notes
$V_{OH(DC)}$	DC output high measurement level (for IV curve linearity)	$0.8 \times VDDQ$	V	
$V_{OM(DC)}$	DC output mid measurement level (for IV curve linearity)	$0.5 \times VDDQ$	V	
$V_{OL(DC)}$	DC output low measurement level (for IV curve linearity)	$0.2 \times VDDQ$	V	
$V_{OH(AC)}$	AC output high measurement level (for output SR)	$VTT + 0.1 \times VDDQ$	V	1
$V_{OL(AC)}$	AC output low measurement level (for output SR)	$VTT - 0.1 \times VDDQ$	V	1

Note :

- The swing of  $\pm 0.1 \times VDDQ$  is based on approximately 50% of the static single ended output high or low swing with a driver impedance of 34ohms and an effective test load of 25ohms to  $VTT = VDDQ/2$ .

### 9.2 Differential AC and DC Output Levels

Symbol	Parameter	DDR3-800/1066/1333/1600	Units	Notes
$V_{OHdiff(AC)}$	AC differential output high measurement level (for output SR)	$+0.2 \times VDDQ$	V	1
$V_{OLdiff(DC)}$	AC differential output low measurement level (for output SR)	$-0.2 \times VDDQ$	V	1

[ Table 15 ] Differential AC and DC output levels

Note :

- The swing of  $\pm 0.2 \times VDDQ$  is based on approximately 50% of the static single ended output high or low swing with a driver impedance of 34ohms and an effective test load of 25ohms to  $VTT = VDDQ/2$  at each of the differential outputs

9.3. Single Ended Output Slew Rate

With the reference load for timing measurements, output slew rate for falling and rising edges is defined and measured between VOL(AC) and VOH(AC) for single ended signals as shown in Table 16 and figure 7.

[ Table 16 ] Single Ended Output slew rate definition

Description	Measured		Defined by
	From	To	
Single ended output slew rate for rising edge	VOL(AC)	VOH(AC)	$\frac{VOH(AC)-VOL(AC)}{\Delta TRse}$
Single ended output slew rate for falling edge	VOH(AC)	VOL(AC)	$\frac{VOH(AC)-VOL(AC)}{\Delta TFse}$

Parameter	Symbol	DDR3-800		DDR3-1066		DDR3-1333		DDR3-1600		Units
		Min	Max	Min	Max	Min	Max	Min	Max	
Single ended output slew rate	SRQse	2.5	5	2.5	5	2.5	5	TBD	5	V/ns

[ Table 17 ] Single Ended Output slew rate

Note : Output slew rate is verified by design and characterization, and may not be subject to production test.

For Ron=RZQ/7 setting

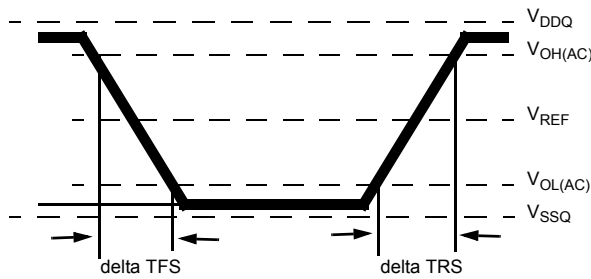

Figure 7. Single Ended Output Slew Rate definition

9.4 Differential Output Slew Rate

With the reference load for timing measurements, output slew rate for falling and rising edges is defined and measured between VOLdiff(AC) and VOHdiff(AC) for differential signals as shown in Table 18 and figure 8.

[ Table 18 ] Differential Output slew rate definition

Description	Measured		Defined by
	From	To	
Differential output slew rate for rising edge	VOLdiff(AC)	VOHdiff(AC)	$\frac{VOHdiff(AC)-VOLdiff(AC)}{\Delta TRdiff}$
Differential output slew rate for falling edge	VOHdiff(AC)	VOLdiff(AC)	$\frac{VOHdiff(AC)-VOLdiff(AC)}{\Delta TFdiff}$

Parameter	Symbol	DDR3-800		DDR3-1066		DDR3-1333		DDR3-1600		Units
		Min	Max	Min	Max	Min	Max	Min	Max	
Single ended output slew rate	SRQse	5	10	5	10	5	10	TBD	10	V/ns

[ Table 19 ] Differential Output slew rate

Note : Output slew rate is verified by design and characterization, and may not be subject to production test.

For Ron=RZQ/7 setting

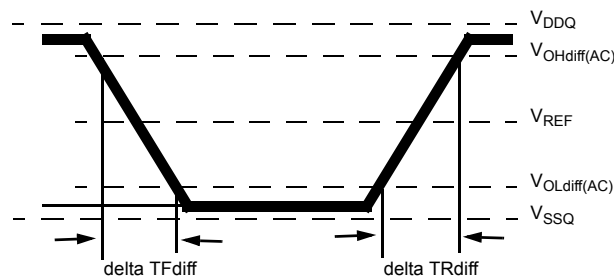

Figure 8. Differential Output Slew Rate definition

### 9.5 Reference Load for AC Timing and Output Slew Rate

Figure 9 represents the effective reference load of 25 ohms used in defining the relevant AC timing parameters of the device as well as output slew rate measurements.

It is not intended as a precise representation of any particular system environment or a depiction of the actual load presented by a production tester. System designers should use IBIS or other simulation tools to correlate the timing reference load to a system environment. Manufacturers correlate to their production test conditions, generally one or more coaxial transmission lines terminated at the tester electronics.

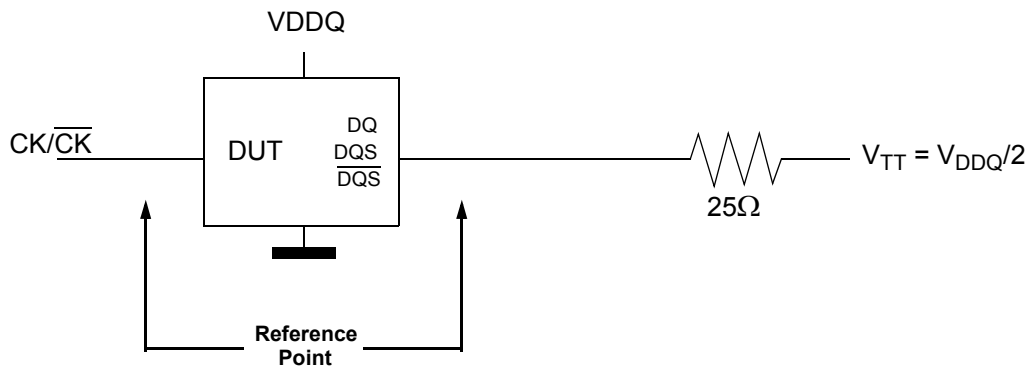

Figure 9. Reference Load for AC Timing and Output Slew Rate

9.6 Overshoot/Undershoot Specification

9.6.1 Address and Control Overshoot and Undershoot specifications

AC Overshoot/Undershoot Specification for Address and Control Pins

(A0-A12, BA0-BA2, CS, RAS, CAS, WE, CKE, ODT)

Parameter	Specification			
	DDR3-800	DDR3-1066	DDR3-1333	DDR3-1600
Maximum peak amplitude allowed for overshoot area (See Figure 8)	0.4V	0.4V	0.4V	0.4V
Maximum peak amplitude allowed for undershoot area (See Figure 8)	0.4V	0.4V	0.4V	0.4V
Maximum overshoot area above VDD (See Figure 8)	0.67V-ns	0.5V-ns	0.4V-ns	0.33V-ns
Maximum undershoot area below VSS (See Figure 8)	0.67V-ns	0.5V-ns	0.4V-ns	0.33V-ns

[ Table 20 ] AC overshoot/undershoot specification for Address and Control pins

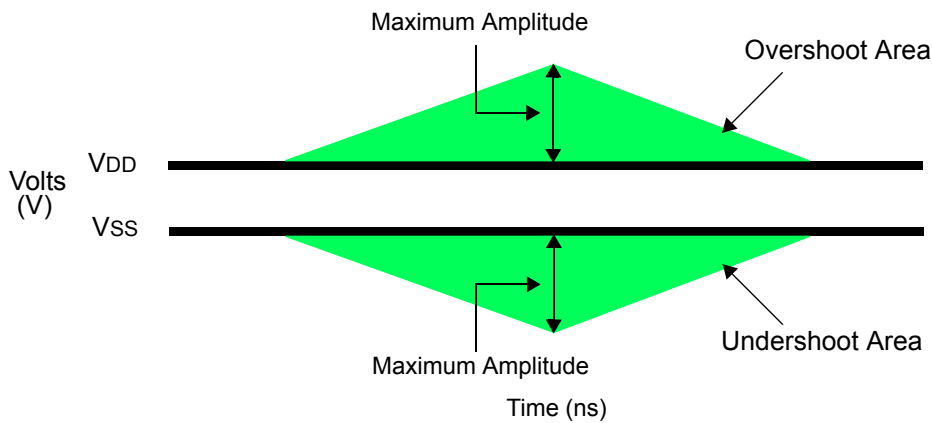

Figure 10. Address and Control Overshoot and Undershoot definition

9.6.2 Clock, Data, Strobe and Mask Overshoot and Undershoot specifications

AC Overshoot/Undershoot Specification for Clock, Data, Strobe, and Mask Pins

(DQ, DQS, DQS, DM, CK, CK)

Parameter	Specification			
	DDR3-800	DDR3-1066	DDR3-1333	DDR3-1600
Maximum peak amplitude allowed for overshoot area (See Figure 9)	0.4V	0.4V	0.4V	0.4V
Maximum peak amplitude allowed for undershoot area (See Figure 9)	0.4V	0.4V	0.4V	0.4V
Maximum overshoot area above VDDQ (See Figure 9)	0.25V-ns	0.19V-ns	0.15V-ns	0.13V-ns
Maximum undershoot area below VSSQ (See Figure 9)	0.25V-ns	0.19V-ns	0.15V-ns	0.13V-ns

[ Table 21 ] AC overshoot/undershoot specification for Clock, Data, Strobe and Mask

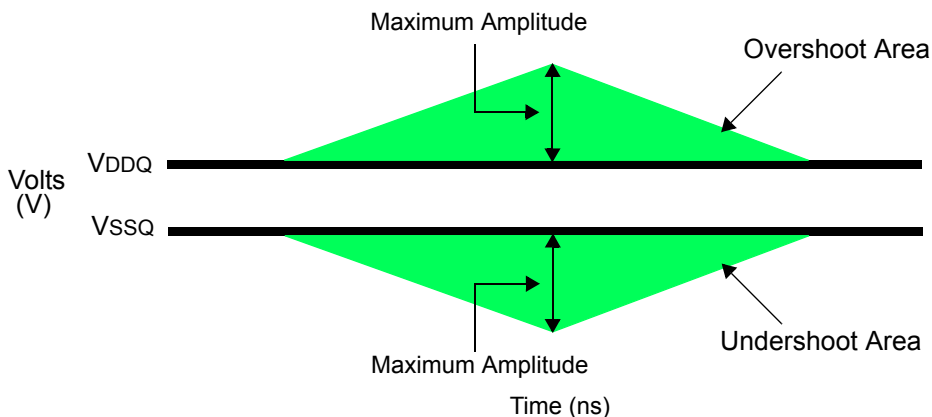

Figure 11. Clock, Data, Strobe and Mask Overshoot and Undershoot definition

9.7 34 ohm Output Driver DC Electrical Characteristics

A functional representation of the output buffer is shown below. Output driver impedance RON is defined by the value of external reference resistor RZQ as follows:

$$RON_{34} = RZQ/7 \text{ (Nominal 34ohms +/- 10% with nominal RZQ=240ohm)}$$

The individual Pull-up and Pull-down resistors (RONpu and RONpd) are defined as follows

$$RON_{pu} = \frac{VDDQ - V_{out}}{|I_{out}|} \text{ under the condition that } RON_{pd} \text{ is turned off}$$

$$RON_{pd} = \frac{V_{out}}{|I_{out}|} \text{ under the condition that } RON_{pu} \text{ is turned off}$$

Output Driver : Definition of Voltages and Currents

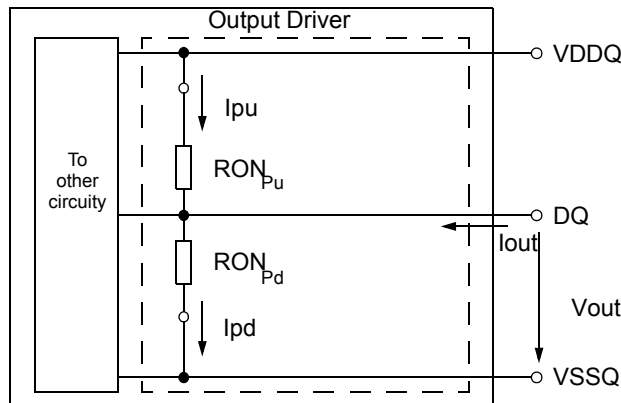

Figure 12. Output Driver : Definition of Voltages and Currents

[ Table 22 ] Output Driver DC Electrical Characteristics, assuming RZQ=240 ohms ; entire operating temperature range; after proper ZQ calibration

RONnom	Resistor	Vout	Min	Nom	Max	Units	Notes
34Ohms	RON34pd	VOLdc = 0.2 x VDDQ	0.6	1.0	1.1	RZQ/7	1,2,3
		VOMdc = 0.5 x VDDQ	0.9	1.0	1.1	RZQ/7	1,2,3
		VOHdc = 0.8 x VDDQ	0.9	1.0	1.4	RZQ/7	1,2,3
	RON34pu	VOLdc = 0.2 x VDDQ	0.9	1.0	1.4	RZQ/7	1,2,3
		VOMdc = 0.5 x VDDQ	0.9	1.0	1.1	RZQ/7	1,2,3
		VOHdc = 0.8 x VDDQ	0.6	1.0	1.1	RZQ/7	1,2,3
Mismatch between Pull-up and Pull-down, MMpupd		VOMdc = 0.5 x VDDQ	-10		10	%	1,2,4

Note :

- The tolerance limits are specified after calibration with stable voltage and temperature. For the behavior of the tolerance limits if temperature or voltage changes after calibration, see following section on voltage and temperature sensitivity
- The tolerance limits are specified under the condition that VDDQ = VDD and that VSSQ = VSS
- Pull-down and pull-up output driver impedance are recommended to be calibrated at 0.5 X VDDQ. Other calibration schemes may be used to achieve the linearity spec shown above, e.g. calibration at 0.2 X VDDQ and 0.8 X VDDQ
- Measurement definition for mismatch between pull-up and pull-down, MMpupd: Measure RONpu and RONpd. both at 0.5 X VDDQ:

$$MMpupd = \frac{RON_{pu} - RON_{pd}}{RON_{nom}} \times 100$$



9.7.1 Output Drive Temperature and Voltage sensitivity

If temperature and/or voltage change after calibration, the tolerance limits widen according to table below

$\Delta T = T - T(@\text{calibration})$ ;  $\Delta V = VDDQ - VDDQ (@\text{calibration})$ ;  $VDD = VDDQ$

\* $dR_{ONdT}$  and  $dR_{ONdV}$  are not subject to production test but are verified by design and characterization

[ Table 23 ] Output Driver Sensitivity Definition

	Min	Max	Units
$R_{ONPU}@V_{OHDC}$	$0.6 - dR_{ONdTH} *  \Delta T  - dR_{ONdVH} *  \Delta V $	$1.1 + dR_{ONdTH} *  \Delta T  + dR_{ONdVH} *  \Delta V $	RZQ/7
$R_{ON}@V_{OMDC}$	$0.9 - dR_{ONdTM} *  \Delta T  - dR_{ONdVM} *  \Delta V $	$1.1 + dR_{ONdTM} *  \Delta T  + dR_{ONdVM} *  \Delta V $	RZQ/7
$R_{ONPD}@V_{OLDC}$	$0.6 - dR_{ONdTL} *  \Delta T  - dR_{ONdVL} *  \Delta V $	$1.1 + dR_{ONdTL} *  \Delta T  + dR_{ONdVL} *  \Delta V $	RZQ/7

[ Table 24 ] Output Driver Voltage and Temperature Sensitivity

	Min	Max	Units
$dR_{ONdTM}$	0	1.5	%/°C
$dR_{ONdVM}$	0	0.15	%/mV
$dR_{ONdTL}$	0	1.5	%/°C
$dR_{ONdVL}$	0	TBD	%/mV
$dR_{ONdTH}$	0	1.5	%/°C
$dR_{ONdVH}$	0	TBD	%/mV

9.8 On-Die Termination (ODT) Levels and I-V Characteristics

On-Die Termination effective resistance  $R_{TT}$  is defined by bits A9, A6 and A2 of MR1 register.

ODT is applied to the DQ, DQ, DQS/DQS and TDQS, TDQS (x8 devices only) pins.

A functional representation of the on-die termination is shown below. The individual pull-up and pull-down resistors ( $R_{TTpu}$  and  $R_{TTpd}$ ) are defined as follows :

$$R_{TTpu} = \frac{VDDQ - V_{out}}{I_{out}} \quad \text{under the condition that } R_{TTpd} \text{ is turned off}$$

$$R_{TTpd} = \frac{V_{out}}{I_{out}} \quad \text{under the condition that } R_{TTpu} \text{ is turned off}$$

On-Die Termination : Definition of Voltages and Currents

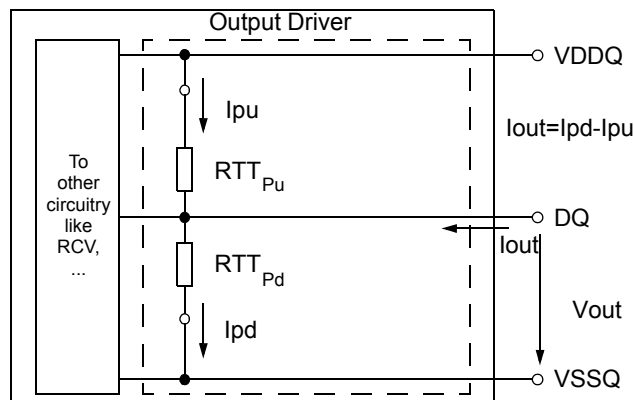

Figure 13. On-Die Termination : Definition of Voltages and Currents

## 9.8.1 ODT DC electrical characteristics

Table # provides an overview of the ODT DC electrical characteristics. The values for  $RTT_{60pd120}$ ,  $RTT_{60pu120}$ ,  $RTT_{120pd240}$ ,  $RTT_{120pu240}$ ,  $RTT_{40pd80}$ ,  $RTT_{40pu80}$ ,  $RTT_{30pd60}$ ,  $RTT_{30pu60}$ ,  $RTT_{20pd40}$ ,  $RTT_{20pu40}$  are not specification requirements, but can be used as design guide lines:.

MR1 (A9,A6,A2)	RTT	RESISTOR	Vout	MIN	NOM	MAX	UNIT	NOTES
(0,1,0)	120 ohm	RTT <sub>120pd240</sub>	0.2XVDDQ	0.6	1.0	1.1	R <sub>ZQ</sub>	1,2,3,4
			0.5XVDDQ	0.9	1.0	1.1	R <sub>ZQ</sub>	1,2,3,4
			0.8XVDDQ	0.9	1.0	1.4	R <sub>ZQ</sub>	1,2,3,4
		RTT <sub>120pu240</sub>	0.2XVDDQ	0.9	1.0	1.4	R <sub>ZQ</sub>	1,2,3,4
			0.5XVDDQ	0.9	1.0	1.1	R <sub>ZQ</sub>	1,2,3,4
			0.8XVDDQ	0.6	1.0	1.1	R <sub>ZQ</sub>	1,2,3,4
RTT <sub>120</sub>	V <sub>IL(AC)</sub> TO V <sub>IH(AC)</sub>	0.9	1.0	1.6	R <sub>ZQ</sub> /2	1,2,5		
(0,0,1)	60 ohm	RTT <sub>60pd240</sub>	0.2XVDDQ	0.6	1.0	1.1	R <sub>ZQ</sub> /2	1,2,3,4
			0.5XVDDQ	0.9	1.0	1.1	R <sub>ZQ</sub> /2	1,2,3,4
			0.8XVDDQ	0.9	1.0	1.4	R <sub>ZQ</sub> /2	1,2,3,4
		RTT <sub>60pu240</sub>	0.2XVDDQ	0.9	1.0	1.4	R <sub>ZQ</sub> /2	1,2,3,4
			0.5XVDDQ	0.9	1.0	1.1	R <sub>ZQ</sub> /2	1,2,3,4
			0.8XVDDQ	0.6	1.0	1.1	R <sub>ZQ</sub> /2	1,2,3,4
RTT <sub>60</sub>	V <sub>IL(AC)</sub> TO V <sub>IH(AC)</sub>	0.9	1.0	1.6	R <sub>ZQ</sub> /4	1,2,5		
(0,1,1)	40 ohm	RTT <sub>40pd240</sub>	0.2XVDDQ	0.6	1.0	1.1	R <sub>ZQ</sub> /3	1,2,3,4
			0.5XVDDQ	0.9	1.0	1.1	R <sub>ZQ</sub> /3	1,2,3,4
			0.8XVDDQ	0.9	1.0	1.4	R <sub>ZQ</sub> /3	1,2,3,4
		RTT <sub>40pu240</sub>	0.2XVDDQ	0.9	1.0	1.4	R <sub>ZQ</sub> /3	1,2,3,4
			0.5XVDDQ	0.9	1.0	1.1	R <sub>ZQ</sub> /3	1,2,3,4
			0.8XVDDQ	0.6	1.0	1.1	R <sub>ZQ</sub> /3	1,2,3,4
RTT <sub>40</sub>	V <sub>IL(AC)</sub> TO V <sub>IH(AC)</sub>	0.9	1.0	1.6	R <sub>ZQ</sub> /6	1,2,5		
(1,0,1)	30 ohm	RTT <sub>60pd240</sub>	0.2XVDDQ	0.6	1.0	1.1	R <sub>ZQ</sub> /4	1,2,3,4
			0.5XVDDQ	0.9	1.0	1.1	R <sub>ZQ</sub> /4	1,2,3,4
			0.8XVDDQ	0.9	1.0	1.4	R <sub>ZQ</sub> /4	1,2,3,4
		RTT <sub>60pu240</sub>	0.2XVDDQ	0.9	1.0	1.4	R <sub>ZQ</sub> /4	1,2,3,4
			0.5XVDDQ	0.9	1.0	1.1	R <sub>ZQ</sub> /4	1,2,3,4
			0.8XVDDQ	0.6	1.0	1.1	R <sub>ZQ</sub> /4	1,2,3,4
RTT <sub>60</sub>	V <sub>IL(AC)</sub> TO V <sub>IH(AC)</sub>	0.9	1.0	1.6	R <sub>ZQ</sub> /8	1,2,5		
(1,0,0)	20 ohm	RTT <sub>60pd240</sub>	0.2XVDDQ	0.6	1.0	1.1	R <sub>ZQ</sub> /6	1,2,3,4
			0.5XVDDQ	0.9	1.0	1.1	R <sub>ZQ</sub> /6	1,2,3,4
			0.8XVDDQ	0.9	1.0	1.4	R <sub>ZQ</sub> /6	1,2,3,4
		RTT <sub>60pu240</sub>	0.2XVDDQ	0.9	1.0	1.4	R <sub>ZQ</sub> /6	1,2,3,4
			0.5XVDDQ	0.9	1.0	1.1	R <sub>ZQ</sub> /6	1,2,3,4
			0.8XVDDQ	0.6	1.0	1.1	R <sub>ZQ</sub> /6	1,2,3,4
RTT <sub>60</sub>	V <sub>IL(AC)</sub> TO V <sub>IH(AC)</sub>	0.9	1.0	1.6	R <sub>ZQ</sub> /12	1,2,5		
Deviation of VM w.r.t VDDQ/2, ΔVM				-5		5	%	1,2,5,6

[ Table 25 ] ODT DC Electrical characteristics, assuming RZQ=240 ohm +/- 1% entire operating temperature range; after proper ZQ calibration

**Note :**

1. The tolerance limits are specified after calibration with stable voltage and temperature. For the behavior of the tolerance limits if temperature or voltage changes after calibration, see following section on voltage and temperature sensitivity
2. The tolerance limits are specified under the condition that VDDQ = VDD and that VSSQ = VSS
3. Pull-down and pull-up ODT resistors are recommended to be calibrated at 0.5XVDDQ. Other calibration schemes may be used to achieve the linearity spec shown above, e.g. calibration at 0.2XVDDQ and 0.8XVDDQ.
4. Not a specification requirement, but a design guide line
5. Measurement definition for RTT:

Apply  $V_{IH}(ac)$  to pin under test and measure current  $I(V_{IH}(ac))$ , then apply  $V_{IL}(ac)$  to pin under test and measure current  $I(V_{IL}(ac))$  respectively

$$RTT = \frac{V_{IH}(ac) - V_{IL}(ac)}{I(V_{IH}(ac)) - I(V_{IL}(ac))}$$

6. Measurement definition for VM and  $\Delta VM$  : Measure voltage (VM) at test pin (midpoint) with no load

$$\Delta VM = \left( \frac{2 \times VM}{VDDQ} - 1 \right) \times 100$$

**9.8.2 ODT Temperature and Voltage sensitivity**

If temperature and/or voltage change after calibration, the tolerance limits widen according to table below

$\Delta T = T - T(@calibration)$ ;  $\Delta V = VDDQ - VDDQ(@calibration)$ ;  $VDD = VDDQ$

**[ Table 26 ] ODT Sensitivity Definition**

	Min	Max	Units
RTT	$0.9 - dR_{TT}dT *  \Delta T  - dR_{TT}dV *  \Delta V $	$1.6 + dR_{TT}dT *  \Delta T  + dR_{TT}dV *  \Delta V $	RZQ/2,4,6,8,12

**[ Table 27 ] ODT Voltage and Temperature Sensitivity**

	Min	Max	Units
$dR_{TT}dT$	0	1.5	%/°C
$dR_{TT}dV$	0	0.15	%/mV

These parameters may not be subject to production test. They are verified by design and characterization.

9.9 ODT Timing Definitions

9.9.1 Test Load for ODT Timings

Different than for timing measurements, the reference load for ODT timings is defined in Figure 14.

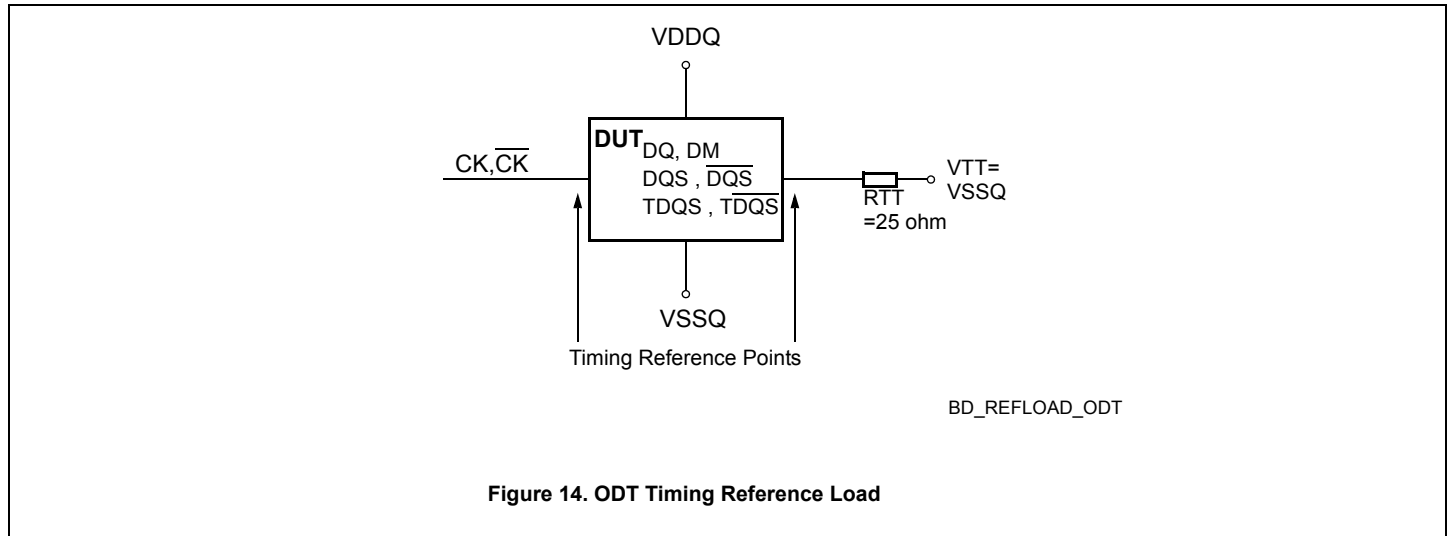

9.9.2 ODT Timing Definition

Definitions for  $t_{AON}$ ,  $t_{AONPD}$ ,  $t_{AOF}$ ,  $t_{AOFPD}$  and  $t_{ADC}$  are provided in Table 28 and subsequent figures. Measurement reference settings are provided in Table 29.

[ Table 28 ] ODT Timing Definitions

Symbol	Begin Point Definition	End Point Definition	Figure
$t_{AON}$	Rising edge of CK - $\overline{CK}$ defined by the end point of ODTLon	Extrapolated point at VSSQ	Figure 2
$t_{AONPD}$	Rising edge of CK - $\overline{CK}$ with ODT being first registered high	Extrapolated point at VSSQ	Figure 3
$t_{AOF}$	Rising edge of CK - $\overline{CK}$ defined by the end point of ODTLoff	End point: Extrapolated point at VRTT_Nom	Figure 4
$t_{AOFPD}$	Rising edge of CK - $\overline{CK}$ with ODT being first registered low	End point: Extrapolated point at VRTT_Nom	Figure 5
$t_{ADC}$	Rising edge of CK - $\overline{CK}$ defined by the end point of ODTLcwn, ODTLcwn4 of ODTLcwn8	End point: Extrapolated point at VRTT_Wr and VRTT_Nom respectively	Figure 6

[ Table 29 ] Reference Settings for ODT Timing Measurements

Measured Parameter	RTT_Nom Setting	RTT_Wr Setting	V <sub>sw1</sub> [V]	V <sub>sw2</sub> [V]	Note
$t_{AON}$	$R_{ZQ}/4$	NA	0.05	0.10	
	$R_{ZQ}/12$	NA	0.10	0.20	
$t_{AONPD}$	$R_{ZQ}/4$	NA	0.05	0.10	
	$R_{ZQ}/12$	NA	0.10	0.20	
$t_{AOF}$	$R_{ZQ}/4$	NA	0.05	0.10	
	$R_{ZQ}/12$	NA	0.10	0.20	
$t_{AOFPD}$	$R_{ZQ}/4$	NA	0.05	0.10	
	$R_{ZQ}/12$	NA	0.10	0.20	
$t_{ADC}$	$R_{ZQ}/12$	$R_{ZQ}/2$	0.20	0.30	

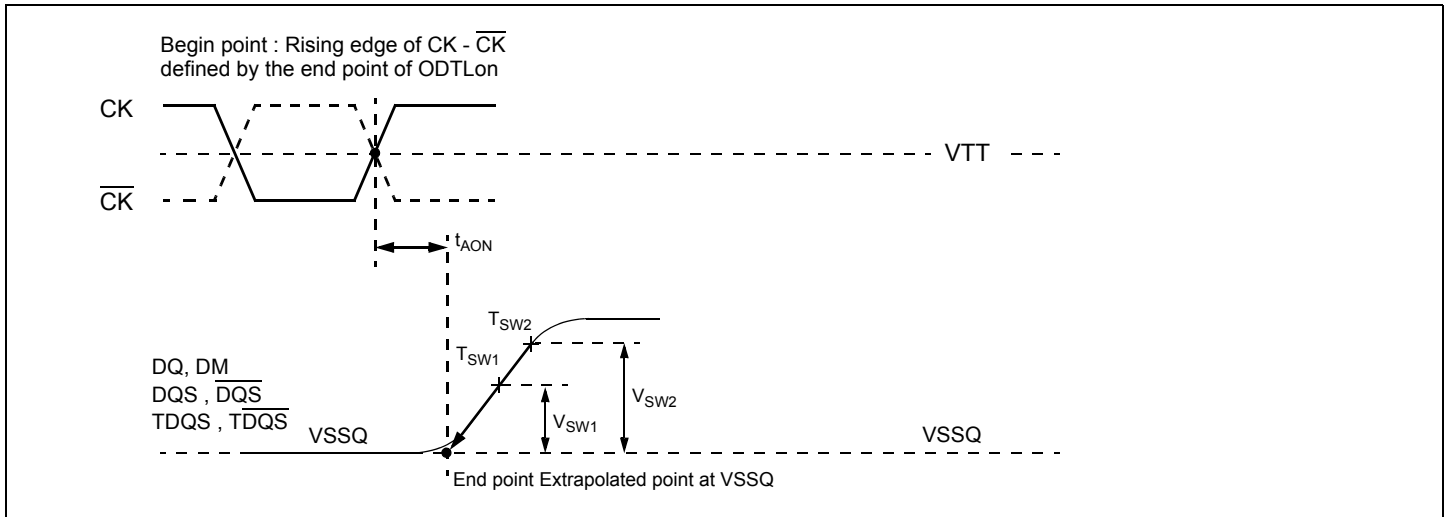

Figure 15. Definition of tAON

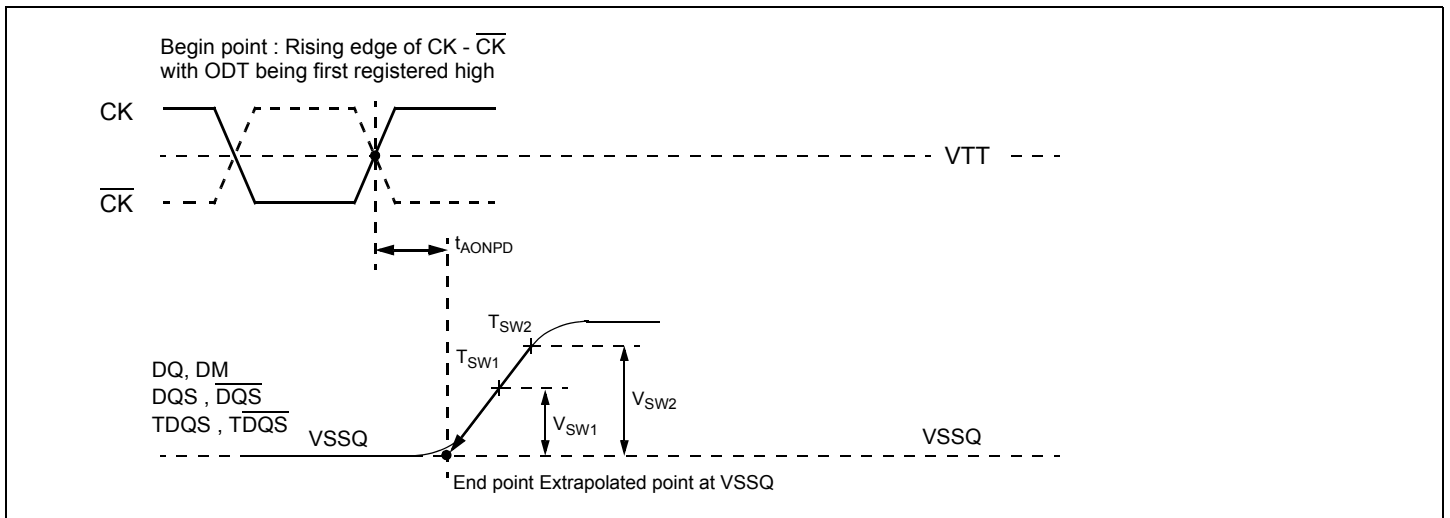

Figure 16. Definition of tAONPD

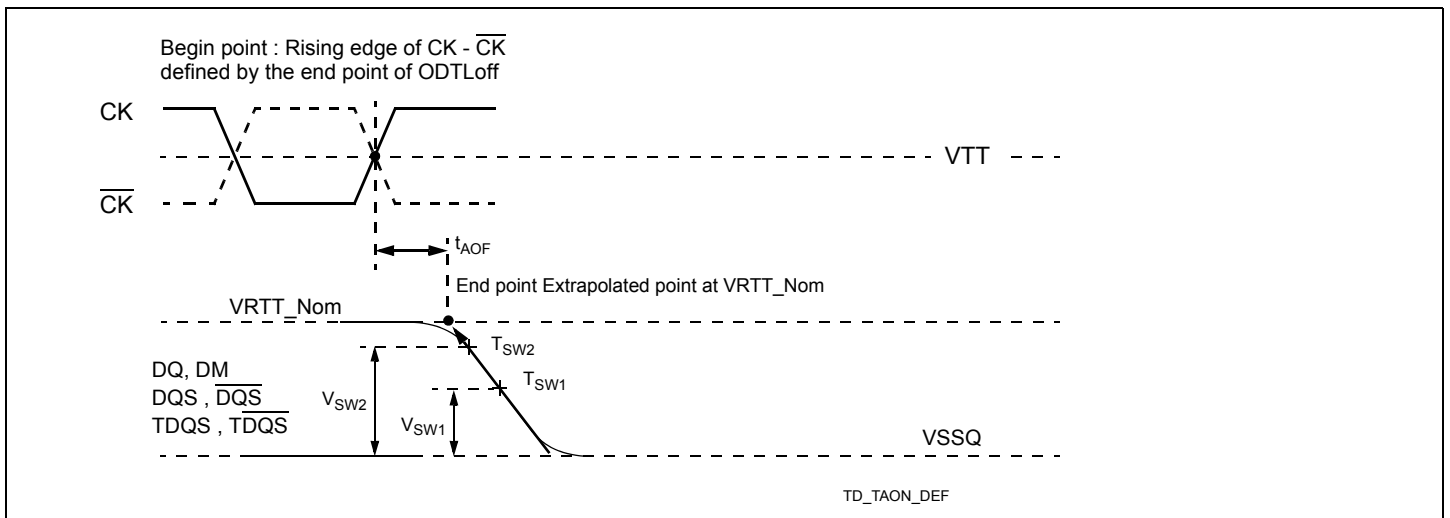

Figure 17. Definition of tAOF

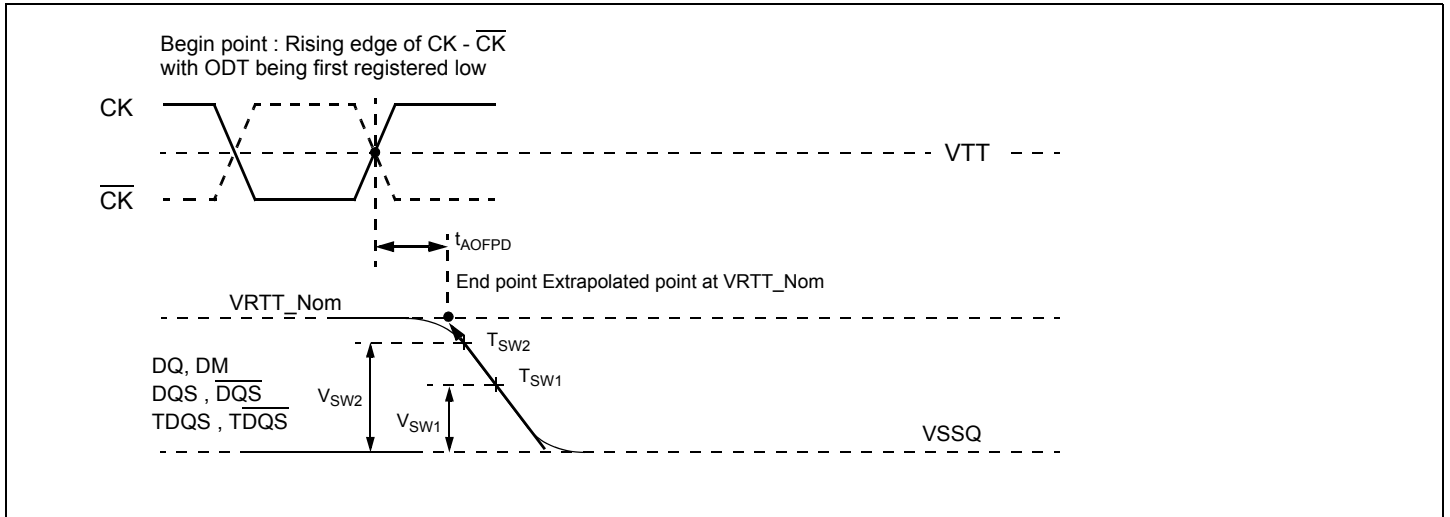

Figure 18. Definition of tAOFPD

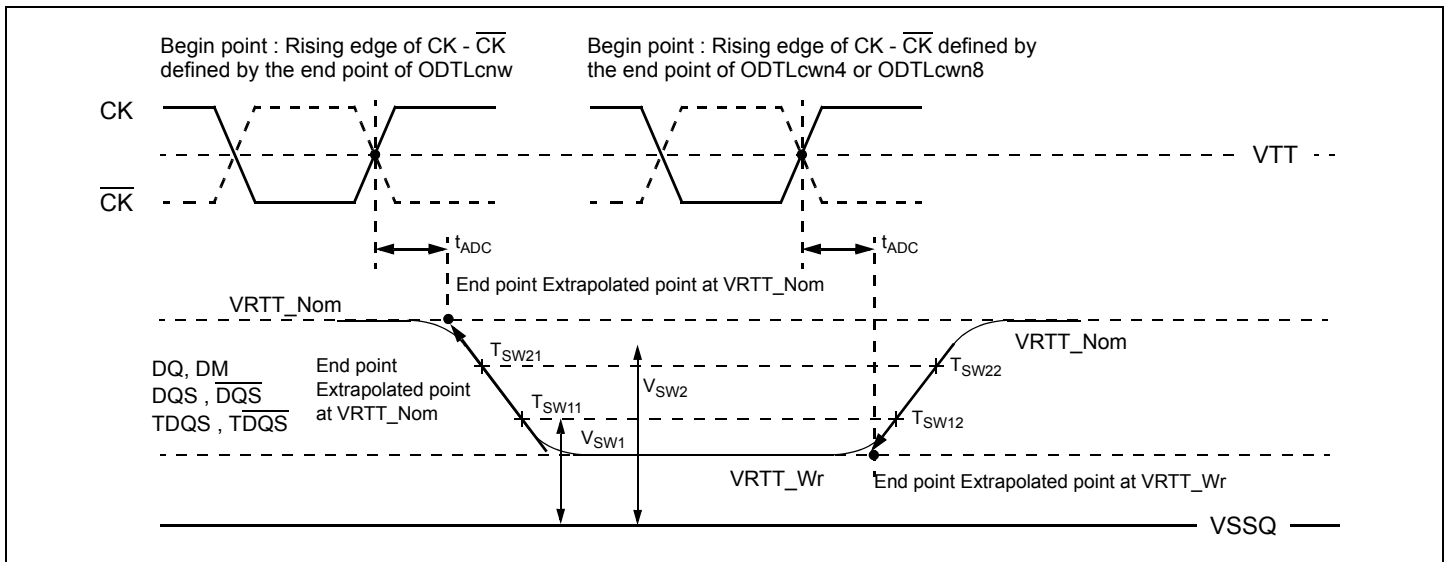

Figure 19. Definition of tADC

## 10.0 Idd Specification Parameters and Test Conditions

### 10.1 IDD Measurement Conditions

Within the tables provided further down, an overview about the IDD measurement conditions is provided as follows:

[ Table 30 ] Overview of Tables providing IDD Measurement Conditions and DRAM Behavior

Table number	Measurement Conditions
Table 34	IDD0 and IDD1
Table 35	IDD2N, IDD2Q, IDD2P(0), IDD2P(1)
Table 36	IDD3N and IDD3P
Table 37	IDD4R, IDD4W, IDD7
Table 38	IDD7 for different speed grades and different tRRD, tFAW conditions
Table 39	IDD5B
Table 40	IDD6, IDD6ET

Within the tables about IDD measurement conditions, the following definitions are used:

- LOW is defined as  $V_{IN} \leq V_{ILAC}(\text{max.})$ ; HIGH is defined as  $V_{IN} \geq V_{IHAC}(\text{min.})$ ;
- STABLE is defined as inputs are stable at a HIGH or LOW level
- FLOATING is defined as inputs are  $V_{REF} = V_{DDQ} / 2$
- SWITCHING is defined as described in the following 2 tables.

[ Table 31 ] Definition of SWITCHING for Address and Command Input Signals

SWITCHING for Address (row, column) and Command Signals ( $\overline{CS}$ , $\overline{RAS}$ , $\overline{CAS}$ , $\overline{WE}$ ) is defined as:	
<b>Address</b> (Row, Column):	If not otherwise mentioned the inputs are stable at HIGH or LOW during 4 clocks and change then to the opposite value (e.g. Ax Ax Ax Ax Ax Ax Ax Ax Ax Ax Ax ..... please see each IDDX definition for details
<b>Bank address:</b>	If not otherwise mentioned the bank addresses should be switched like the row/ column addresses - please see each IDDX definition for details
<b>Command</b> ( $\overline{CS}$ , $\overline{RAS}$ , $\overline{CAS}$ , $\overline{WE}$ ):	Define $D = \{\overline{CS}, \overline{RAS}, \overline{CAS}, \overline{WE}\} := \{\text{HIGH}, \text{LOW}, \text{LOW}, \text{LOW}\}$ Define $\overline{D} = \{\overline{CS}, \overline{RAS}, \overline{CAS}, \overline{WE}\} := \{\text{HIGH}, \text{HIGH}, \text{HIGH}, \text{HIGH}\}$  Define Command Background Pattern = D D $\overline{D}$ $\overline{D}$ D D $\overline{D}$ $\overline{D}$ D D $\overline{D}$ $\overline{D}$ ...  If other commands are necessary (e.g. ACT for IDD0 or Read for IDD4R) the Background Pattern Command is substituted by the respective $\overline{CS}$ , $\overline{RAS}$ , $\overline{CAS}$ , $\overline{WE}$ levels of the necessary command. See each IDDX definition for details and figures 1,2,3 as examples.

[ Table 32 ] Definition of SWITCHING for Data (DQ)

SWITCHING for Data (DQ) is defined as	
<b>Data</b> (DQ)	Data DQ is changing between HIGH and LOW every other data transfer (once per clock) for DQ signals, which means that data DQ is stable during one clock; see each IDDX definition for exceptions from this rule and for further details. See figures 1,2,3 as examples.
<b>Data Masking (DM)</b>	NO Switching; DM must be driven LOW all the time

Timing parameters are listed in the following table:

[ Table 33 ] For IDD testing the following parameters are utilized.

Parameter Bin		DDR3-800	DDR3-1066		DDR3-1333		Unit
		6-6-6	7-7-7	8-8-8	8-8-8	9-9-9	
t <sub>CKmin</sub> (IDD)		2.5	1.875		1.5		ns
CL(IDD)		6	7	8	8	9	
t <sub>RCDmin</sub> (IDD)		15	13.13	15	12	13.5	ns
t <sub>RCmin</sub> (IDD)		52.5	50.63	52.50	48	49.5	ns
t <sub>RASmin</sub> (IDD)		37.5	37.5	37.5	36	36	ns
t <sub>RPmin</sub> (IDD)		15	13.13	15	12	13.5	ns
t <sub>FAW</sub> (IDD)	x4/x8	40	37.5	37.5	30	30	ns
	x16	50	50	50	45	45	ns
t <sub>RRD</sub> (IDD)	x4/x8	10	7.5	7.5	6.0	6.0	ns
	x16	10	10	10	7.5	7.5	ns
t <sub>RFC</sub> (IDD) - 1Gb		110	110	110	110	110	110

The following conditions apply:

1. IDD specifications are tested after the device is properly initialized.
2. Input slew rate is specified by AC Parametric test conditions.
3. IDD parameters are specified with ODT and output buffer disabled (MR1 Bit A12).



[ Table 34 ] IDD Measurement Conditions for IDD0 and IDD1

Current	IDD0	IDD1
Name	Operating Current 0 -> One Bank Activate -> Precharge	Operating Current 1 -> One Bank Activate -> Read -> Precharge
<b>Measurement Condition</b>		
Timing Diagram Example		Figure 1
CKE	HIGH	HIGH
External Clock	on	on
t <sub>CK</sub>	t <sub>CKmin</sub> (IDD)	t <sub>CKmin</sub> (IDD)
t <sub>RC</sub>	t <sub>RCmin</sub> (IDD)	t <sub>RCmin</sub> (IDD)
t <sub>RAS</sub>	t <sub>RASmin</sub> (IDD)	t <sub>RASmin</sub> (IDD)
t <sub>RCD</sub>	n.a.	t <sub>RCDmin</sub> (IDD)
t <sub>RRD</sub>	n.a.	n.a.
CL	n.a.	CL(IDD)
AL	n.a.	0
$\overline{\text{CS}}$	HIGH between. Activate and Precharge Commands	HIGH between Activate, Read and Precharge
Command Inputs ( $\overline{\text{CS}}$ , $\overline{\text{RAS}}$ , $\overline{\text{CAS}}$ , $\overline{\text{WE}}$ )	SWITCHING as described in Table 2; only exceptions are Activate and Precharge commands; example of IDD0 pattern:  A0 D $\overline{\text{D}}$ $\overline{\text{D}}$ D D $\overline{\text{D}}$ $\overline{\text{D}}$ D D $\overline{\text{D}}$ $\overline{\text{D}}$ P0 (DDR3-800: t <sub>RAS</sub> = 37.5ns between (A)ctivate and (P)recharge to bank 0 ; Definition of D and $\overline{\text{D}}$ : see Table 2)  Definition of D and $\overline{\text{D}}$ : See table ##.	SWITCHING as described in Table 2; only exceptions are Activate, Read and Precharge commands; example of IDD1 pattern:  A0 D $\overline{\text{D}}$ $\overline{\text{D}}$ D R0 D $\overline{\text{D}}$ $\overline{\text{D}}$ DD $\overline{\text{D}}$ $\overline{\text{D}}$ DD $\overline{\text{D}}$ P0 (DDR3-800 -555: t <sub>RCD</sub> = 12.5ns between (A)ctivate and (R)ead to bank 0 ; Definition of D and $\overline{\text{D}}$ : see Table 2)  Definition of D and $\overline{\text{D}}$ : See table ##.
Row, Column Addresses	Row addresses SWITCHING as described in Table 2; Address Input A10 must be LOW all the time!	Row addresses SWITCHING as described in Table 2; Address Input A10 must be LOW all the time!
Bank Addresses	bank address is fixed (bank 0)	bank address is fixed (bank 0)
Data I/O	SWITCHING as described in Table 3	Read Data: output data switches every clock, which means that Read data is stable during one clock cycle. To achieve I <sub>out</sub> = 0mA the output buffer should be switched off by MR1 Bit A12 set to "1". When there is no read data burst from DRAM the DQ I/O should be FLOATING.
Output Buffer DQ,DQS / MR1 bit A12	off / 1	off / 1
Rtt_NOM, Rtt_WR	disabled	disabled
Burst length	n.a.	8 fixed / MR0 Bits [A1, A0] = {0,0}
Active banks	one ACT-PRE loop	one ACT-RD-PRE loop
Idle banks	all other	all other
Precharge Power Down Mode / Mode Register Bit 12	n.a.	n.a.

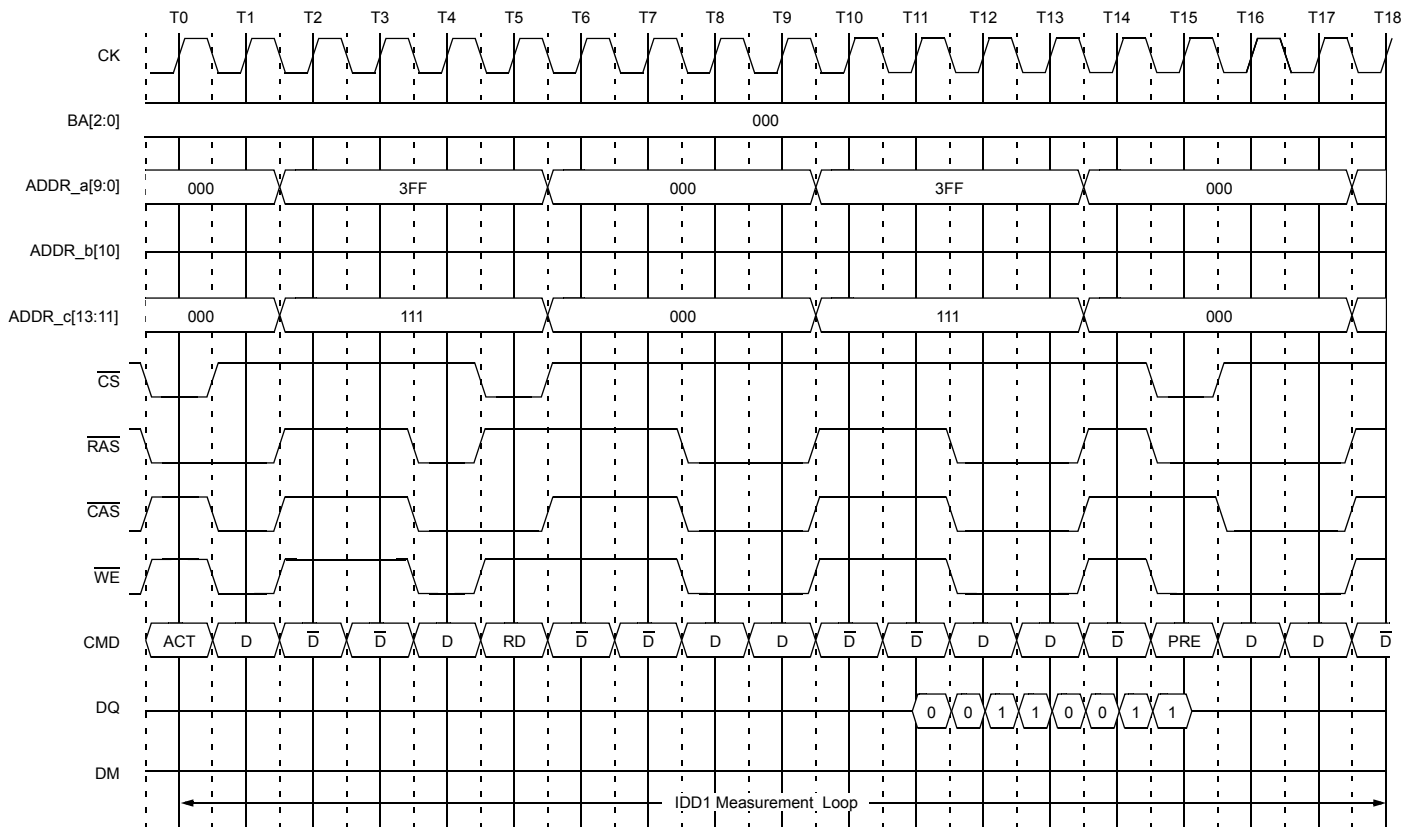

Figure 20.

IDD1 Example (DDR3-800-666, 1Gb x8): Data DQ is shown but the output buffer should be switched off (per MR1 Bit A12 = "1") to achieve  $I_{out} = 0mA$ . Address inputs are split into 3 parts.

[ Table 35 ] IDD Measurement Conditions for IDD2N, IDD2P(1), IDD2P(0) and IDD2Q

Current	IDD2N	IDD2P(1) a	IDD2P(0)	IDD2Q
Name	Precharge Standby Current	Precharge Power Down Current Fast Exit - MRS A12 Bit = 1	Precharge Power Down Current Slow Exit - MRS A12 Bit = 0	Precharge Quiet Standby Current
<b>Measurement Condition</b>				
Timing Diagram Example	Figure 2			
CKE	HIGH	LOW	LOW	LOW
External Clock	on	on	on	on
t <sub>CK</sub>	t <sub>CKmin</sub> (IDD)	t <sub>CKmin</sub> (IDD)	t <sub>CKmin</sub> (IDD)	t <sub>CKmin</sub> (IDD)
t <sub>RC</sub>	n.a.	n.a.	n.a.	n.a.
t <sub>RAS</sub>	n.a.	n.a.	n.a.	n.a.
t <sub>RCD</sub>	n.a.	n.a.	n.a.	n.a.
t <sub>RRD</sub>	n.a.	n.a.	n.a.	n.a.
CL	n.a.	n.a.	n.a.	n.a.
AL	n.a.	n.a.	n.a.	n.a.
$\overline{\text{CS}}$	HIGH	STABLE	HIGH	STABLE
Bank Address, Row Addr. and Command Inputs	SWITCHING as described in Table 2	STABLE	STABLE	STABLE
Data inputs	SWITCHING	FLOATING	FLOATING	FLOATING
Output Buffer DQ,DQS / MR1 bit A12	off / 1	off / 1	off / 1	off / 1
Rtt_NOM, Rtt_WE	disabled	disabled	disabled	disabled
Burst length	n.a.	n.a.	n.a.	n.a.
Active banks	none	none	none	none
Idle banks	all	all	all	all
Precharge Power Down Mode / Mode Register Bit <sup>a</sup>	n.a.	Fast Exit / 1 (any valid command after t <sub>XP1</sub> )	Slow Exit / 0 Slow exit (RD and ODT commands must satisfy t <sub>XPDLL-AL</sub> )	n.a.

Note :

- In DDR3 the MRS Bit 12 defines DLL on/off behavior ONLY for precharge power down. There are 2 different Precharge Power Down states possible : one with DLL on (fast exit, bit 12 = 1) and one with DLL off (slow exit, bit 12 = 0).
- Because it is an exit after precharge power down the valid commands are: Activate, Refresh, Mode-Register Set, Enter - Self Refresh.

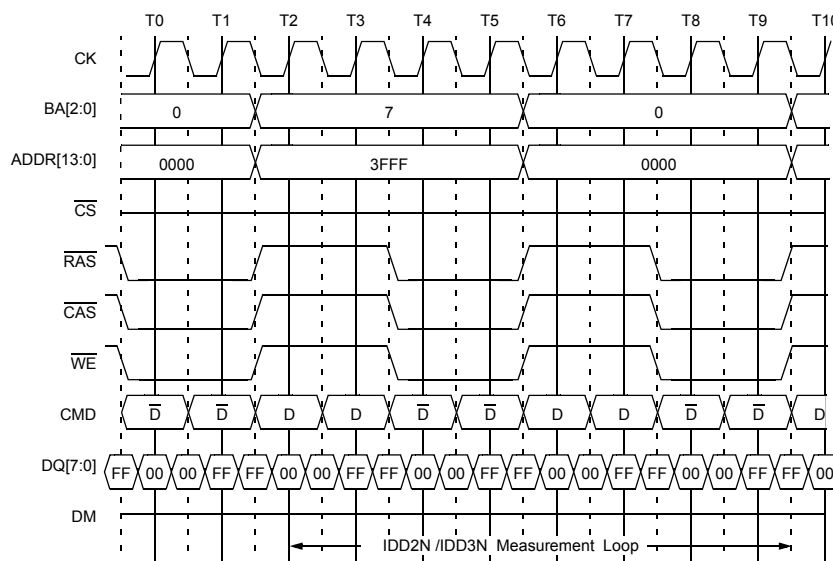

Figure 21. IDD2N /IDD3N Example (DDR3-800-666, 1Gb X8)

[ Table36 ] IDD Measurement Conditions for IDD3N and IDD3P(fast exit)

Current	IDD3N	IDD3P
Name	Active Standby Current	Active Power-Down Current <sup>a</sup> Always Fast Exit
<b>Measurement Condition</b>		
Timing Diagram Example	Figure 2	
CKE	HIGH	LOW
External Clock	on	on
t <sub>CK</sub>	t <sub>CKmin</sub> (IDD)	t <sub>CKmin</sub> (IDD)
t <sub>RC</sub>	n.a.	n.a.
t <sub>RAS</sub>	n.a.	n.a.
t <sub>RCD</sub>	n.a.	n.a.
t <sub>RRD</sub>	n.a.	n.a.
CL	n.a.	n.a.
AL	n.a.	n.a.
$\overline{\text{CS}}$	HIGH	STABLE
Addr. and cmd Inputs	SWITCHING as described in Table 2	STABLE
Data inputs	SWITCHING as described in Table 3	FLOATING
Output Buffer DQ,DQS / MR1 bit A12	off / 1	off / 1
Rtt_NOM, Rtt_WE	disabled	disabled
Burst length	n.a.	n.a.
Active banks	all	all
Idle banks	none	none
Precharge Power Down Mode / Mode Register Bit <sup>a</sup>	n.a.	n.a. (Active Power Down Mode is always "Fast Exit" with DLL on

Note :

1. DDR3 will offer only ONE active power down mode with DLL on (-> fast exit). MRS bit 12 will not be used for active power down. Instead bit A12 will be used to switch between two different precharge power down modes.

[ Table 37 ] IDD Measurement Conditions for IDD4R, IDD4W and IDD7

Current	IDD4R	IDD4W	IDD7
Name	Operating Current Burst Read	Operating Current Burst Write	All Bank Interleave Read Current
<b>Measurement Condition</b>			
Timing Diagram Example	Figure 3		
CKE	HIGH	HIGH	HIGH
External Clock	on	on	on
t <sub>CK</sub>	t <sub>CKmin</sub> (IDD)	t <sub>CKmin</sub> (IDD)	t <sub>CKmin</sub> (IDD)
t <sub>RC</sub>	n.a.	n.a.	t <sub>RCmin</sub> (IDD)
t <sub>RAS</sub>	n.a.	n.a.	t <sub>RASmin</sub> (IDD)
t <sub>RCD</sub>	n.a.	n.a.	t <sub>RCDmin</sub> (IDD)
t <sub>RRD</sub>	n.a.	n.a.	t <sub>RRDmin</sub> (IDD)
CL	CL(IDD)	CL(IDD)	CL(IDD)
AL	0	0	t <sub>RCDmin</sub> -1t <sub>CK</sub>
$\overline{CS}$	HIGH btw. valid cmds	HIGH btw. valid cmds	HIGH btw. valid cmds
Command Inputs ( $\overline{CS}$ , RAS, CAS, WE)	SWITCHING as described in Table 2; exceptions are Read commands => IDD4R Pattern: R0DDDR1DDDR3DDDR3DDDR4 ..... Rx = Read from bank x; Definition of D and D: see Table 2	SWITCHING as described in Table 2; exceptions are Write commands => IDD4W Pattern: W0DDDW1DDDW2DDDW3DDDW4 ... Wx = Write to bank x; Definition of D and D: see Table 2	For patterns see Table 9
Row, Column Addresses	column addresses SWITCHING as described in Table 2; Address Input A10 must be LOW all the time!	column addresses SWITCHING as described in Table 2; Address Input A10 must be LOW all the time!	STABLE during DESELECTs
Bank Addresses	bank address cycling (0 ->1 -> 2 -> 3 ...)	bank address cycling (0 ->1 -> 2 -> 3 ...)	bank address cycling (0 ->1 -> 2 -> 3 ...), see pattern in Table 9
DQ I/O	Seamless Read Data Burst (BL8): output data switches every clock, which means that Read data is stable during one clock cycle. To achieve I <sub>out</sub> = 0mA the output buffer should be switched off by MR1 Bit A12 set to "1".	Seamless Write Data Burst (BL8): input data switches every clock, which means that Write data is stable during one clock cycle. DM is low all the time.	Read Data (BL8): output data switches every clock, which means that Read data is stable during one clock cycle. To achieve I <sub>out</sub> = 0mA the output buffer should be switched off by MR1 Bit A12 set to "1".
Output Buffer DQ,DQS / MR1 bit A12	off / 1	off / 1	off / 1
Rtt_NOM, Rtt_WE	disabled	disabled	disabled
Burst length	8 fixed / MR0 Bits [A1, A0] = {0,0}	8 fixed / MR0 Bits [A1, A0] = {0,0}	8 fixed / MR0 Bits [A1, A0] = {0,0}
Active banks	all	all	all
Idle banks	none	none	none
Precharge Power Down Mode / Mode Register Bit	n.a.	n.a.	n.a.

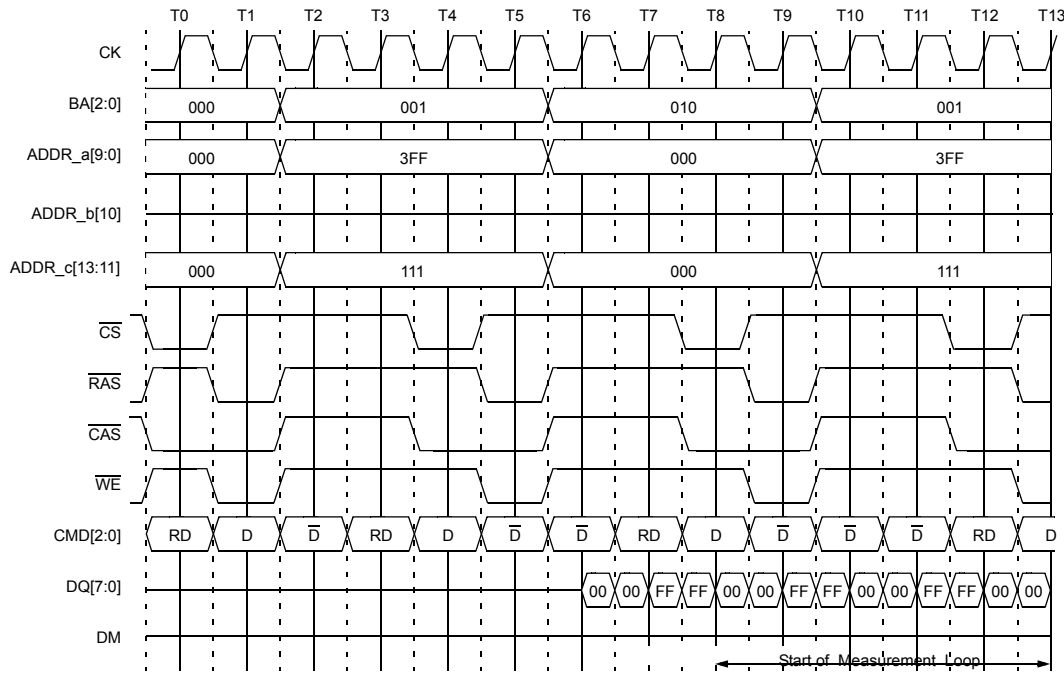

**Figure 22**  
**IDD4R Example (DDR3-800-666,1Gb x8): data DQ is shown but the output buffer should be switched off (per MR1 Bit A12="1") to achieve Iout = 0mA. Address inputs are split into 3 parts.**

[ Table 38 ] IDD7 Pattern for different Speed Grades and different tRRD, tFAW conditions

Speed Mb/s	Bin	Org.	tFAW	tFAW	tRRD	tRRD	IDD7 Pattern <sup>a</sup>
			[ns]	[CLK]	[ns]	[CLK]	
800	all	x4/x8	40	16	10	4	A0 RA0 D D A1 RA1 D D A2 RA2 D D A3 RA3 DD A4 RA4 D D A5 RA5 D D A6 RA6 D D A7 RA7D D
	all	x16	50	20	10	4	A0 RA0 D D A1 RA1 D D A2 RA2 D D A3 RA3 DD D D D D A4 RA4 D D A5 RA5 D D A6 RA6 DD A7 RA7 D D D D D D
1066	all	x4/x8	37.5	20	7.5	4	A0 RA0 D D A1 RA1 D D A2 RA2 D D A3 RA3 DD D D D D A4 RA4 D D A5 RA5 D D A6 RA6 DD A7 RA7 D D D D D D
	all	x16	50	27	10	6	A0 RA0 D D D D A1 RA1 D D D D A2 RA2 D DD D A3 RA3 D D D D D D A4 RA4 D D D D A5RA5 D D D D A6 RA6 D D D D A7 RA7 D D D DD D D D D D D
1333	all	x4/x8	30	20	6	4	A0 RA0 D D A1 RA1 D D A2 RA2 D D A3 RA3 DD D D D D A4 RA4 D D A5 RA5 D D A6 RA6 DD A7 RA7 D D D D D D
	all	x16	45	30	7.5	5	A0 RA0 D D D D A1 RA1 D D D D A2 RA2 D D D A3RA3 D D D D D D D D D D D D A4 RA4 D D DA5 RA5 D D D A6 RA6 D D D A7 RA7 D D D DD D D D D D D D D D D
1600	all	x4/x8	30	24	6	5	A0 RA0 D D D A1 RA1 D D D A2 RA2 D D D A3RA3 D D D D D D D D A4 RA4 D D D A5 RA5 D DD A6 RA6 D D D A7 RA7 D D D D D D D D
	all	x16	40	32	7.5	6	A0 RA0 D D D D A1 RA1 D D D D A2 RA2 D DD D A3 RA3 D D D D D D D D D D D D D D A4 RA4D D D D A5 RA5 D D D D A6 RA6 D D D D A7RA7 D D D D D D D D D D D D D D D D

Note :  
 1. A0 = Activation of Bank 0; RA0 = Read with Auto-Precharge of Bank 0; D = Deselect

[ Table 39 ] IDD Measurement Conditions for IDD5B

Current	IDD5B
Name	Burst Refresh Current
<b>Measurement Condition</b>	
CKE	HIGH
External Clock	on
$t_{CK}$	$t_{CKmin}(IDD)$
$t_{RC}$	n.a.
$t_{RAS}$	n.a.
$t_{RCD}$	n.a.
$t_{RRD}$	n.a.
$t_{RFC}$	$t_{RFCmin}(IDD)$
CL	n.a.
AL	n.a.
$\overline{CS}$	HIGH btw. valid cmds
Addr. and cmd Inputs	SWITCHING
Data inputs	SWITCHING
Output Buffer DQ,DQS / MR1 bit A12	off / 1
Rtt_NOM, Rtt_WE	disabled
Burst length	n.a.
Active banks	Refresh command every $t_{RFC}=t_{RFCmin}$
Idle banks	none
Precharge Power Down Mode / Mode Register Bit	n.a.

[ Table 40 ] IDD Measurement Conditions for IDD6 and IDD6ET

Current	IDD6	IDD6ET
Name	Self-Refresh Current Normal Temperature Range TCASE = 0 .. 85°C	Self-Refresh Current Extended Temperature Range a TCASE = 0 .. 95°C
<b>Measurement Condition</b>		
Temperature	TCASE = 85°C	TCASE = 95°C
Auto Self Refresh(ASR) / MR2 Bit A6	Disabled / "0"	Disabled / "0"
Self Refresh Temperature Range (SRT) / MR2 Bit A7	Normal / "0"	Enabled / "1"
CKE	LOW	LOW
External Clock	OFF; CK and $\overline{CK}$ at LOW	OFF; CK and $\overline{CK}$ at LOW
$t_{CK}$	n.a.	n.a.
$t_{RC}$	n.a.	n.a.
$t_{RAS}$	n.a.	n.a.
$t_{RCD}$	n.a.	n.a.
$t_{RRD}$	n.a.	n.a.
CL	n.a.	n.a.
AL	n.a.	n.a.
$\overline{CS}$	FLOATING	FLOATING
Command Inputs ( $\overline{CS}$ , $\overline{RAS}$ , $\overline{CAS}$ , $\overline{WE}$ )	FLOATING	FLOATING
Row, Column Addresses	FLOATING	FLOATING
Bank Addresses	FLOATING	FLOATING
Data I/O	FLOATING	FLOATING
Output Buffer DQ,DQS / MR1 bit A12	off / 1	off / 1
Rtt_NOM, Rtt_WR	disabled	disabled
Burst length	n.a.	n.a.
Active banks	all during self-refresh actions	all during self-refresh actions
Idle banks	all btw. Self-Refresh actions	all btw. Self-Refresh actions
Precharge Power Down Mode / Mode Register Bit 12	n.a.	n.a.

Note :

1 .Users should refer to the DRAM supplier datasheet and/or the DIMM SPD to determine if DDR3 SDRAM devices support the following options referred to in this material

[ Table 41 ] IDD6 current definition

Symbol	Parameter/Condition
IDD6	Normal Temperature Range Self-Refresh Current : CKE< 0.2V; external clock off, CK and $\overline{CK}$ at 0V; Other control and address inputs are FLOATING; Data Bus inputs are FLOATING, PASR disabled. Applicable for MR2 setting A6=0 and A7=0.
IDD6ET	Extended Temperature Range Self-Refresh Current: CKE<0.2V; external clock off, CK and $\overline{CK}$ at 0V; Other control and address inputs are FLOATING; Data Bus inputs are FLOATING, PASR disabled. Applicable for MR2 settings A6=0 and A7=1.



## 10.2 IDD Specifications

(IDD values are for full operating range of Voltage and Temperature)

Symbol	Conditions	Units	Notes
IDD0	<b>Operating one bank active-precharge current;</b> $t_{CK} = t_{CK}(IDD)$ , $t_{RC} = t_{RC}(IDD)$ , $t_{RAS} = t_{RASmin}(IDD)$ ; CKE is HIGH, $\overline{CS}$ is HIGH between valid commands; Address bus inputs are SWITCHING; Data bus inputs are SWITCHING	mA	
IDD1	<b>Operating one bank active-read-precharge current;</b> $I_{OUT} = 0mA$ ; BL = 8, CL = CL(IDD), AL = 0; $t_{CK} = t_{CK}(IDD)$ , $t_{RC} = t_{RC}(IDD)$ , $t_{RAS} = t_{RASmin}(IDD)$ , $t_{RCD} = t_{RCD}(IDD)$ ; CKE is HIGH, $\overline{CS}$ is HIGH between valid commands; Address bus inputs are SWITCHING; Data pattern is same as IDD4W	mA	
IDD2P	<b>Precharge power-down current;</b> All banks idle; $t_{CK} = t_{CK}(IDD)$ ; CKE is LOW; Other control and address bus inputs are STABLE; Data bus inputs are FLOATING	mA	
IDD2Q	<b>Precharge quiet standby current;</b> All banks idle; $t_{CK} = t_{CK}(IDD)$ ; CKE is HIGH, $\overline{CS}$ is HIGH; Other control and address bus inputs are STABLE; Data bus inputs are FLOATING	mA	
IDD2N	<b>Precharge standby current;</b> All banks idle; $t_{CK} = t_{CK}(IDD)$ ; CKE is HIGH, $\overline{CS}$ is HIGH; Other control and address bus inputs are SWITCHING; Data bus inputs are SWITCHING	mA	
IDD3P	<b>Active power-down current;</b> All banks open; $t_{CK} = t_{CK}(IDD)$ ; CKE is LOW; Other control and address bus inputs are STABLE; Data bus inputs are FLOATING	mA	
IDD3N	<b>Active standby current;</b> All banks open; $t_{CK} = t_{CK}(IDD)$ , $t_{RAS} = t_{RASmax}(IDD)$ , $t_{RP} = t_{RP}(IDD)$ ; CKE is HIGH, $\overline{CS}$ is HIGH between valid commands; Other control and address bus inputs are SWITCHING; Data bus inputs are SWITCHING	mA	
IDD4W	<b>Operating burst write current;</b> All banks open, Continuous burst writes; BL = 8, CL = CL(IDD), AL = 0; $t_{CK} = t_{CK}(IDD)$ , $t_{RAS} = t_{RASmax}(IDD)$ , $t_{RP} = t_{RP}(IDD)$ ; CKE is HIGH, $\overline{CS}$ is HIGH between valid commands; Address bus inputs are SWITCHING; Data bus inputs are SWITCHING	mA	
IDD4R	<b>Operating burst read current;</b> All banks open, Continuous burst reads, $I_{OUT} = 0mA$ ; BL = 8, CL = CL(IDD), AL = 0; $t_{CK} = t_{CK}(IDD)$ , $t_{RAS} = t_{RASmax}(IDD)$ , $t_{RP} = t_{RP}(IDD)$ ; CKE is HIGH, $\overline{CS}$ is HIGH between valid commands; Address bus inputs are SWITCHING; Data pattern is same as IDD4W	mA	
IDD5B	<b>Burst refresh current;</b> $t_{CK} = t_{CK}(IDD)$ ; Refresh command at every $t_{RFC}(IDD)$ interval; CKE is HIGH, $\overline{CS}$ is HIGH between valid commands; Other control and address bus inputs are SWITCHING; Data bus inputs are SWITCHING	mA	
IDD6	<b>Self refresh current;</b> CK and $\overline{CK}$ at 0V; $CKE \leq 0.2V$ ; Other control and address bus inputs are FLOATING; Data bus inputs are FLOATING	mA	
IDD6ET	<b>Extended Temperature Range Self-Refresh Current;</b> CK and $\overline{CK}$ at 0V; $CKE \leq 0.2V$ ; Other control and address inputs are FLOATING; Data Bus inputs are FLOATING, PASR disabled, Applicable for MR2 setting A6=0 and A7=1	mA	
IDD7	<b>Operating bank interleave read current;</b> All bank interleaving reads, $I_{OUT} = 0mA$ ; BL = 8, CL = CL(IDD), AL = $t_{RCD}(IDD) - 1 * t_{CK}(IDD)$ ; $t_{CK} = t_{CK}(IDD)$ , $t_{RC} = t_{RC}(IDD)$ , $t_{RRD} = t_{RRD}(IDD)$ , $t_{RCD} = 1 * t_{CK}(IDD)$ ; CKE is HIGH, $\overline{CS}$ is HIGH between valid commands; Address bus inputs are STABLE during DESELECTs; Data pattern is same as IDD4R;	mA	

[ Table 42 ] IDD Specification

## 1Gb DDR3 SDRAM E-die IDD Spec Table

Symbol	256Mx4 (K4B1G0446C)					Unit	Notes
	800Mbps	1066Mbps		1333Mbps			
	6-6-6	7-7-7	8-8-8	8-8-8	9-9-9		
IDD0	TBD	TBD	TBD	TBD	TBD	mA	
IDD1	TBD	TBD	TBD	TBD	TBD	mA	
IDD2P-F	TBD	TBD	TBD	TBD	TBD	mA	
IDD2P-S	TBD	TBD	TBD	TBD	TBD	mA	
IDD2N	TBD	TBD	TBD	TBD	TBD	mA	
IDD2Q	TBD	TBD	TBD	TBD	TBD	mA	
IDD3P-F	TBD	TBD	TBD	TBD	TBD	mA	
IDD3N	TBD	TBD	TBD	TBD	TBD	mA	
IDD4R	TBD	TBD	TBD	TBD	TBD	mA	
IDD4W	TBD	TBD	TBD	TBD	TBD	mA	
IDD5	TBD	TBD	TBD	TBD	TBD	mA	
IDD6	TBD	TBD	TBD	TBD	TBD	mA	
IDD6ET	TBD	TBD	TBD	TBD	TBD	mA	
IDD7	TBD	TBD	TBD	TBD	TBD	mA	

Symbol	128Mx8 (K4B1G0846C)					Unit	Notes
	800Mbps	1066Mbps		1333Mbps			
	6-6-6	7-7-7	8-8-8	8-8-8	9-9-9		
IDD0	TBD	TBD	TBD	TBD	TBD	mA	
IDD1	TBD	TBD	TBD	TBD	TBD	mA	
IDD2P-F	TBD	TBD	TBD	TBD	TBD	mA	
IDD2P-S	TBD	TBD	TBD	TBD	TBD	mA	
IDD2N	TBD	TBD	TBD	TBD	TBD	mA	
IDD2Q	TBD	TBD	TBD	TBD	TBD	mA	
IDD3P-F	TBD	TBD	TBD	TBD	TBD	mA	
IDD3N	TBD	TBD	TBD	TBD	TBD	mA	
IDD4R	TBD	TBD	TBD	TBD	TBD	mA	
IDD4W	TBD	TBD	TBD	TBD	TBD	mA	
IDD5	TBD	TBD	TBD	TBD	TBD	mA	
IDD6	TBD	TBD	TBD	TBD	TBD	mA	
IDD6ET	TBD	TBD	TBD	TBD	TBD	mA	
IDD7	TBD	TBD	TBD	TBD	TBD	mA	

Symbol	64Mx16 (K4B1G1646C)					Unit	Notes
	800Mbps	1066Mbps		1333Mbps			
	6-6-6	7-7-7	8-8-8	8-8-8	9-9-9		
IDD0	TBD	TBD	TBD	TBD	TBD	mA	
IDD1	TBD	TBD	TBD	TBD	TBD	mA	
IDD2P-F	TBD	TBD	TBD	TBD	TBD	mA	
IDD2P-S	TBD	TBD	TBD	TBD	TBD	mA	
IDD2N	TBD	TBD	TBD	TBD	TBD	mA	
IDD2Q	TBD	TBD	TBD	TBD	TBD	mA	
IDD3P-F	TBD	TBD	TBD	TBD	TBD	mA	
IDD3N	TBD	TBD	TBD	TBD	TBD	mA	
IDD4R	TBD	TBD	TBD	TBD	TBD	mA	
IDD4W	TBD	TBD	TBD	TBD	TBD	mA	
IDD5	TBD	TBD	TBD	TBD	TBD	mA	
IDD6	TBD	TBD	TBD	TBD	TBD	mA	
IDD6ET	TBD	TBD	TBD	TBD	TBD	mA	
IDD7	TBD	TBD	TBD	TBD	TBD	mA	

[ Table 43 ] IDD Specification for 1Gb DDR3 C-die

## 11.0 Input/Output Capacitance

Parameter	Symbol	DDR3-800		DDR3-1066		DDR3-1333		DDR3-1600		Units	Notes
		Min	Max	Min	Max	Min	Max	Min	Max		
Input/output capacitance (DQ, DM, DQS, $\overline{DQS}$ , TDQS, $\overline{TDQS}$ )	CIO	1.5	3.0	1.5	3.0	1.5	2.5	TBD	TBD	pF	1,2,3
Input capacitance (CK and $\overline{CK}$ )	CCK	0.8	1.6	0.8	1.6	0.8	1.4	0.8	1.4	pF	2,3,5
Input capacitance delta (CK and $\overline{CK}$ )	CDCK	0	0.15	0	0.15	0	0.15	0	0.15	pF	2,3,4
Input capacitance (All other input-only pins)	CI	0.75	1.5	0.75	1.5	0.75	1.3	0.75	1.3	pF	2,3,6
Input capacitance delta (DQS and $\overline{DQS}$ )	CDDQS	0	0.2	0	0.2	0	0.15	0	0.15	pF	2,3,12
Input capacitance delta (All control input-only pins)	CDI_CTRL	-0.5	0.3	-0.5	0.3	-0.4	0.2	-0.4	0.2	pF	2,3,7,8
Input capacitance delta (all ADD and CMD input-only pins)	CDI_ADD_CMD	-0.5	0.5	-0.5	0.5	-0.4	0.4	-0.4	0.4	pF	2,3,9,10
Input/output capacitance delta (DQ, DM, DQS, $\overline{DQS}$ , TDQS, $\overline{TDQS}$ )	CDIO	-0.5	0.3	-0.5	0.3	-0.5	0.3	-0.5	0.3	pF	2,3,11
Input/output capacitance of ZQ pin	CZQ	-	3	-	3	-	3	-	3	pF	2, 3, 13

[ Table 44 ] Input / Output Capacitance

Note :

1. Although the DM, TDQS and  $\overline{TDQS}$  pins have different functions, the loading matches DQ and DQS

2. This parameter is not subject to production test. It is verified by design and characterization.

The capacitance is measured according to JEP147("PROCEDURE FOR MEASURING INPUT CAPACITANCE USING A VECTOR NETWORK ANALYZER( VNA)") with VDD, VDDQ, VSS, VSSQ applied and all other pins floating (except the pin under test, CKE, RESET# and ODT as necessary). VDD=VDDQ=1.5V, VBIAS=VDD/2 and on-die termination off.

3. This parameter applies to monolithic devices only; stacked/dual-die devices are not covered here

4. Absolute value of CCK-CCK#

5. Absolute value of CIO(DQS)-CIO(DQS#)

6. CI applies to ODT, CS#, CKE, A0-A15, BA0-BA2, RAS#, CAS#, WE#.

7. CDI\_CTRL applies to ODT, CS# and CKE

8.  $CDI\_CTRL = CI(CTRL) - 0.5 * (CI(CLK) + CI(CLK\#))$ 

9. CDI\_ADD\_CMD applies to A0-A15, BA0-BA2, RAS#, CAS# and WE#

10.  $CDI\_ADD\_CMD = CI(ADD\_CMD) - 0.5 * (CI(CLK) + CI(CLK\#))$ 11.  $CDIO = CIO(DQ,DM) - 0.5 * (CIO(DQS) + CIO(DQS\#))$

## 12.0 Electrical Characteristics and AC timing for DDR3-800 to DDR3-1600

### 12.1 Clock specification

Parameter	Symbol	DDR3-800		DDR3-1066		DDR3-1333		DDR3-1600		Units
		min	max	min	max	min	max	min	max	
Average clock period	tCK(avg)	2500	3333	1875	3333	1500	3333	1250	3333	ps
Clock period	tCK(abs)	tCK(avg)min + tJIT(per)min	tCK(avg)max + tJIT(per)max	tCK(avg)min + tJIT(per)min	tCK(avg)max + tJIT(per)max	tCK(avg)min + tJIT(per)min	tCK(avg)max + tJIT(per)max	tCK(avg)min + tJIT(per)min	tCK(avg)max + tJIT(per)max	ps

[ Table 45 ] Clock specification

#### Add note for tCK(avg)

tCK(avg) is calculated as the average clock period across any consecutive 200 cycle window, where each clock period is calculated from rising edge to rising edge.

$$\sum_{j=1}^N \left( tCK_j \right) / N \quad N=200$$

#### Add note for tCK(abs)

tCK(abs) is the absolute clock period, as measured from one rising edge to the next consecutive rising edge.

## 12.2 Clock Jitter Specification

Parameter	Symbol	DDR3-800		DDR3-1066		DDR3-1333		DDR3-1600		Units
		min	max	min	max	min	max	min	max	
Clock period jitter	tJIT(per)	-100	100	-90	90	-80	80	-70	70	ps
Clock period jitter during DLL locking period	tJIT(per,lck)	-90	90	-80	80	-70	70	-60	60	ps
Cycle to cycle clock period jitter	tJIT(cc)	200		180		160		140		ps
Cycle to cycle clock period jitter during DLL locking period	tJIT(cc,lck)	180		160		140		120		ps
Cumulative error across n cycles	tERR(nper)	TBD	TBD	TBD	TBD	TBD	TBD	TBD	TBD	ps
Average high pulse width	tCH(avg)	0.47	0.53	0.47	0.53	0.47	0.53	0.47	0.53	tCK(avg)
Average low pulse width	tCL(avg)	0.47	0.53	0.47	0.53	0.47	0.53	0.47	0.53	tCK(avg)
Duty cycle jitter	tJIT(duty)	-100	100	-75	75	-60	60	-50	50	ps

[ Table 46 ] Clock Jitter specification

Note : The jitter specified is a random jitter meeting a Gaussian distribution. Input clocks violating the min/max values may result in malfunction of the DDR3 SDRAM device.

**Add note for tCH(avg) and tCL(avg)**

tCH(avg) is defined as the average high pulse width, as calculated across any consecutive 200 high pulses:

tCL(avg) is defined as the average low pulse width, as calculated across any consecutive 200 low pulses:

$$\left( \sum_{j=1}^N tCH_j \right) / N \times tCK(avg) \quad N=200 \qquad \left( \sum_{j=1}^N tCL_j \right) / N \times tCK(avg) \quad N=200$$

**Add note for tJIT(duty)**

tJIT(duty) is defined as the cumulative set of tCH jitter and tCL jitter. tCH jitter is the largest deviation of any single tCH from tCH(avg). tCL jitter is the largest deviation of any single tCL from tCL(avg)

tJIT(duty) = min/max of {tJIT(CH), tJIT(CL)}, where:

tJIT(CH) = {tCHi-tCH(avg) where i=1 to 200}, tJIT(CL) = {tCLi-tCL(avg) where i=1 to 200},

**Add note for tJIT(per), tJIT(per,lck)**

tJIT(per) is defined as the largest deviation of any single tCK from tCK(avg). tJIT(per) = min/max of {tCKi-tCK(avg) where i=1 to 200}

tJIT(per) defines the single period jitter when the DLL is already locked.

tJIT(per,lck) uses the same definition for single period jitter, during the DLL locking period only.

tJIT(per) and tJIT(per,lck) are not guaranteed through final production testing

**Add note for tJIT(cc), tJIT(cc,lck)**

tJIT(cc) is defined as the absolute difference in clock period between two consecutive clock cycles: tJIT(cc) = Max of {tCKi+1-tCKi}

tJIT(cc) defines the cycle to cycle jitter when the DLL is already locked.

tJIT(cc,lck) uses the same definition for cycle to cycle jitter, during the DLL locking period only.

tJIT(cc) and tJIT(cc,lck) are not guaranteed through final production testing

**Add note for tERR(nper)**

tERR is defined as the cumulative error across n multiple consecutive cycles from tCK(avg). This definition is TBD.

## 12.3 Refresh Parameters by Device Density

Parameter	Symbol	512Mb	1Gb	2Gb	4Gb	8Gb	Units
All Bank Refresh to active/refresh cmd time	tRFC	90	110	160	300	350	ns
Average periodic refresh interval	tREFI	0 °C ≤ T <sub>CASE</sub> ≤ 85 °C	7.8	7.8	7.8	7.8	μs
		85 °C < T <sub>CASE</sub> ≤ 95 °C	3.9	3.9	3.9	3.9	μs

[ Table 47 ] Refresh parameters by device density

## 12.4 Standard Speed Bins

DDR3 SDRAM Standard Speed Bins include tCK, tRCD, tRP, tRAS and tRC for each corresponding bin.

[ Table 48 ] DDR3-800 Speed Bins

Speed		DDR3-800		Units	Note
CL-nRCD-nRP		6 - 6 - 6			
Parameter	Symbol	min	max		
Internal read command to first data	t <sub>AA</sub>	15	20	ns	
ACT to internal read or write delay time	t <sub>RCD</sub>	15	-	ns	
PRE command period	t <sub>RP</sub>	15	-	ns	
ACT to ACT or REF command period	t <sub>RC</sub>	52.5	-	ns	
ACT to PRE command period	t <sub>RAS</sub>	37.5	9*tREFI	ns	8
CL = 5 / CWL = 5	t <sub>CK(AVG)</sub>	Reserved		ns	1,2,3,4
CL = 6 / CWL = 5	t <sub>CK(AVG)</sub>	2.5	3.3	ns	1,2,3
Supported CL Settings		6		n <sub>CK</sub>	
Supported CWL Settings		5		n <sub>CK</sub>	

[ Table 49 ] DDR3-1066 Speed Bins

Speed		DDR3-1066		DDR3-1066		Units	Note
CL-nRCD-nRP		7 - 7 - 7		8 - 8 - 8			
Parameter	Symbol	min	max	min	max		
Internal read command to first data	t <sub>AA</sub>	13.125	20	15	20	ns	
ACT to internal read or write delay time	t <sub>RCD</sub>	13.125	-	15	-	ns	
PRE command period	t <sub>RP</sub>	13.125	-	15	-	ns	
ACT to ACT or REF command period	t <sub>RC</sub>	50.625	-	52.5	-	ns	
ACT to PRE command period	t <sub>RAS</sub>	37.5	9*tREFI	37.5	9*tREFI	ns	8
CL = 5	CWL = 5	Reserved		Reserved		ns	1,2,3,4,6
	CWL = 6	Reserved		Reserved		ns	4
CL = 6	CWL = 5	2.5	3.3	2.5	3.3	ns	1,2,3,6
	CWL = 6	Reserved		Reserved		ns	1,2,3,4
CL = 7	CWL = 5	Reserved		Reserved		ns	4
	CWL = 6	1.875	<2.5	Reserved		ns	1,2,3,4
CL = 8	CWL = 5	Reserved		Reserved		ns	4
	CWL = 6	1.875	<2.5	1.875	<2.5	ns	1,2,3
Supported CL Settings		6,7,8		6,8		n <sub>CK</sub>	
Supported CWL Settings		5,6		5,6		n <sub>CK</sub>	

[ Table 50 ] DDR3-1333 Speed Bins

Speed		DDR3-1333		DDR3-1333		Units	Note	
CL-nRCD-nRP		8 - 8 - 8		9 - 9 - 9				
Parameter	Symbol	min	max	min	max			
Internal read command to first data	$t_{AA}$	12	20	13.5	20	ns		
ACT to internal read or write delay time	$t_{RCD}$	12	-	13.5	-	ns		
PRE command period	$t_{RP}$	12	-	13.5	-	ns		
ACT to ACT or REF command period	$t_{RC}$	48	-	49.5	-	ns		
ACT to PRE command period	$t_{RAS}$	36	9*tREFI	36	9*tREFI	ns	8	
CL = 5	CWL = 5	$t_{CK(AVG)}$	2.5	3.3	Reserved		ns	1,2,3,4,7
	CWL = 6,7	$t_{CK(AVG)}$	Reserved		Reserved		ns	4
CL = 6	CWL = 5	$t_{CK(AVG)}$	2.5	3.3	2.5	3.3	ns	1,2,3,7
	CWL = 6	$t_{CK(AVG)}$	Reserved		Reserved		ns	1,2,3,4,7
	CWL = 7	$t_{CK(AVG)}$	Reserved		Reserved		ns	4
CL = 7	CWL = 5	$t_{CK(AVG)}$	Reserved		Reserved		ns	4
	CWL = 6	$t_{CK(AVG)}$	1.875	<2.5	Reserved		ns	1,2,3,4,7
	CWL = 7	$t_{CK(AVG)}$	Reserved		Reserved		ns	1,2,3,4,
CL = 8	CWL = 5	$t_{CK(AVG)}$	Reserved		Reserved		ns	4
	CWL = 6	$t_{CK(AVG)}$	1.875	<2.5	1.875	<2.5	ns	1,2,3,7
	CWL = 7	$t_{CK(AVG)}$	1.5	<1.875	Reserved		ns	1,2,3,4,
CL = 9	CWL = 5,6	$t_{CK(AVG)}$	Reserved		Reserved		ns	4
	CWL = 7	$t_{CK(AVG)}$	1.5	<1.875	1.5	<1.875	ns	1,2,3,4
CL = 10	CWL = 5,6	$t_{CK(AVG)}$	Reserved		Reserved		ns	4
	CWL = 7	$t_{CK(AVG)}$	1.5	<1.875	1.5	<1.875	ns	1,2,3
			(Optional)		(Optional)		ns	5
Supported CL Settings		5,6,7,8,9		6,8,9		$n_{CK}$		
Supported CWL Settings		5,6,7		5,6,7		$n_{CK}$		

**NOTES:**

Absolute Specification (TOPER;VDDQ=VDD=1.5V +/- 0.075V);

- The CL setting and CWL setting result in  $t_{CK(AVG).MIN}$  and  $t_{CK(AVG).MAX}$  requirements. When making a selection of  $t_{CK(AVG)}$ , both need to be fulfilled: Requirements from CL setting as well as requirements from CWL setting.
- $t_{CK(AVG).MIN}$  limits: Since CAS Latency is not purely analog - data and strobe output are synchronized by the DLL - all possible intermediate frequencies may not be guaranteed. An application should use the next smaller JEDEC standard  $t_{CK(AVG)}$  value (2.5, 1.875, 1.5, or 1.25 ns) when calculating  $CL [nCK] = tAA [ns] / t_{CK(AVG)} [ns]$ , rounding up to the next 'Supported CL'.
- $t_{CK(AVG).MAX}$  limits: Calculate  $t_{CK(AVG)} = tAA.MAX / CLSELECTED$  and round the resulting  $t_{CK(AVG)}$  down to the next valid speed bin limit (i.e. 3.3ns or 2.5ns or 1.875 ns or 1.25 ns). This result is  $t_{CK(AVG).MAX}$  corresponding to CLSELECTED.
- 'Reserved' settings are not allowed. User must program a different value.
- 'Optional' settings allow certain devices in the industry to support this setting, however, it is not a mandatory feature. Refer to supplier's data sheet and SPD information if and how this setting is supported.
- Any DDR3-1066 speed bin also supports functional operation at lower frequencies as shown in the table which are not subject to Production Tests but verified by Design/Characterization.
- Any DDR3-1333 speed bin also supports functional operation at lower frequencies as shown in the table which are not subject to Production Tests but verified by Design/Characterization.
- $t_{REFI}$  depends on TOPER

## 13.0 Timing Parameters by Speed Grade

[ Table 51 ] Timing Parameters by Speed Bin

Speed		DDR3-800		DDR3-1066		DDR3-1333		Units	Note
Parameter	Symbol	MIN	MAX	MIN	MAX	MIN	MAX		
<b>Clock Timing</b>									
Minimum Clock Cycle Time (DLL off mode)	$t_{CK(DLL\_OFF)}$	8	-	8	-	8	-	ns	6
Average Clock Period	$t_{CK(ave)}$	See Speed Bins Table						ps	f
Clock Period	$t_{CK(abs)}$	$t_{CK(ave)min} + t_{JIT(per)min}$	$t_{CK(ave)max} + t_{JIT(per)max}$	$t_{CK(ave)min} + t_{JIT(per)min}$	$t_{CK(ave)max} + t_{JIT(per)max}$	$t_{CK(ave)min} + t_{JIT(per)min}$	$t_{CK(ave)max} + t_{JIT(per)max}$	ps	
Average high pulse width	$t_{CH(ave)}$	0.47	0.53	0.47	0.53	0.47	0.53	$t_{CK(ave)}$	f
Average low pulse width	$t_{CL(ave)}$	0.47	0.53	0.47	0.53	0.47	0.53	$t_{CK(ave)}$	f
Clock Period Jitter	$t_{JIT(per)}$	-100	100	-90	90	-80	80	ps	
Clock Period Jitter during DLL locking period	$t_{JIT(per, lck)}$	-90	90	-80	80	-70	70	ps	
Cycle to Cycle Period Jitter	$t_{JIT(cc)}$	200		180		160		ps	
Cycle to Cycle Period Jitter during DLL locking period	$t_{JIT(cc, lck)}$	180		160		140		ps	
Cumulative error across 2 cycles	$t_{ERR(2per)}$	-147	147	-132	132	-118	118	ps	
Cumulative error across 3 cycles	$t_{ERR(3per)}$	-175	175	-157	157	-140	140	ps	
Cumulative error across 4 cycles	$t_{ERR(4per)}$	-194	194	-175	175	-155	155	ps	
Cumulative error across 5 cycles	$t_{ERR(5per)}$	-209	209	-188	188	-168	168	ps	
Cumulative error across 6 cycles	$t_{ERR(6per)}$	-222	222	-200	200	-177	177	ps	
Cumulative error across 7 cycles	$t_{ERR(7per)}$	-232	232	-209	209	-186	186	ps	
Cumulative error across 8 cycles	$t_{ERR(8per)}$	-241	241	-217	217	-193	193	ps	
Cumulative error across 9 cycles	$t_{ERR(9per)}$	-249	249	-224	224	-200	200	ps	
Cumulative error across 10 cycles	$t_{ERR(10per)}$	-257	257	-231	231	-205	205	ps	
Cumulative error across 11 cycles	$t_{ERR(11per)}$	-263	263	-237	237	-210	210	ps	
Cumulative error across 12 cycles	$t_{ERR(12per)}$	-269	269	-242	242	-215	215	PS	
Cumulative error across n = 13, 14 ... 49, 50 cycles	$t_{ERR(nper)}$	$t_{ERR(nper)min} = (1 + 0.68\ln(n)) * t_{JIT(per)min}$ $t_{ERR(nper)max} = (1 + 0.68\ln(n)) * t_{JIT(per)max}$							
Absolute clock HIGH pulse width	$t_{CH(abs)}$	0.43		0.43		0.43		$t_{CK(ave)}$	25
Absolute clock Low pulse width	$t_{CL(abs)}$	0.43		0.43		0.43		$t_{CK(ave)}$	26
<b>Data Timing</b>									
DQS, $\overline{DQS}$ to DQ skew, per group, per access	$t_{DQSQ}$	-	200	-	150	-	125	ps	12,13
DQ output hold time from DQS, $\overline{DQS}$	$t_{QH}$	0.38	-	0.38	-	0.38	-	$t_{CK(ave)}$	12,13
DQ low-impedance time from CK, $\overline{CK}$	$t_{LZ(DQ)}$	-800	400	-600	300	-500	250	ps	13,14, a
DQ high-impedance time from CK, $\overline{CK}$	$t_{HZ(DQ)}$	-	400	-	300	-	250	ps	13,14, a
Data setup time to DQS, $\overline{DQS}$ referenced to Vih(ac)Vil(ac) levels	$t_{DS(base)}$	75	-	25	-	-10	-	ps	d, 17
Data hold time to DQS, $\overline{DQS}$ referenced to Vih(ac)Vil(ac) levels	$t_{DH(base)}$	150	-	100	-	65	-	ps	d, 17
<b>Data Strobe Timing</b>									
DQS, $\overline{DQS}$ READ Preamble	$t_{RPRE}$	0.9	-	0.9	-	0.9	-	$t_{CK}$	13, 19, b
DQS, $\overline{DQS}$ differential READ Postamble	$t_{RPST}$	0.3	NOTE1	0.3	NOTE1	0.3	NOTE1	$t_{CK}$	11, 13, b
DQS, $\overline{DQS}$ output high time	$t_{QSH}$	0.38	-	0.38	-	0.4	-	$t_{CK(ave)}$	13, b
DQS, $\overline{DQS}$ output low time	$t_{QSL}$	0.38	-	0.38	-	0.4	-	$t_{CK(ave)}$	13, b
DQS, $\overline{DQS}$ WRITE Preamble	$t_{WPRE}$	0.9	-	0.9	-	0.9	-	$t_{CK}$	1
DQS, $\overline{DQS}$ WRITE Postamble	$t_{WPST}$	0.3	-	0.3	-	0.3	-	$t_{CK}$	1
DQS, $\overline{DQS}$ rising edge output access time from rising CK, $\overline{CK}$	$t_{DQSCK}$	-400	400	-300	300	-255	255	ps	12,13
DQS, $\overline{DQS}$ low-impedance time (Referenced from RL-1)	$t_{LZ(DQS)}$	-800	400	-600	300	-500	250	ps	12,13,14
DQS, $\overline{DQS}$ high-impedance time (Referenced from RL+BL/2)	$t_{HZ(DQS)}$	-	400	-	300	-	250	ps	12,13,14
DQS, $\overline{DQS}$ differential input low pulse width	$t_{DQSL}$	0.4	0.6	0.4	0.6	0.4	0.6	$t_{CK}$	
DQS, $\overline{DQS}$ differential input high pulse width	$t_{DQSH}$	0.4	0.6	0.4	0.6	0.4	0.6	$t_{CK}$	
DQS, $\overline{DQS}$ rising edge to CK, $\overline{CK}$ rising edge	$t_{DQSS}$	-0.25	0.25	-0.25	0.25	-0.25	0.25	$t_{CK(ave)}$	c
DQS, $\overline{DQS}$ falling edge setup time to CK, $\overline{CK}$ rising edge	$t_{DSS}$	0.2	-	0.2	-	0.2	-	$t_{CK(ave)}$	c
DQS, $\overline{DQS}$ falling edge hold time to CK, $\overline{CK}$ rising edge	$t_{DSH}$	0.2	-	0.2	-	0.2	-	$t_{CK(ave)}$	c



[ Table 51 ] Timing Parameters by Speed Bin (Cont.)

Speed		DDR3-800		DDR3-1066		DDR3-1333		Units	Note
Parameter	Symbol	MIN	MAX	MIN	MAX	MIN	MAX		
<b>Command and Address Timing</b>									
DLL locking time	t <sub>DLLK</sub>	512	-	512	-	512	-	nCK	
internal READ Command to PRECHARGE Command delay	t <sub>RTP</sub>	max (4t <sub>CK</sub> , 7.5ns)	-	max (4t <sub>CK</sub> , 7.5ns)	-	max (4t <sub>CK</sub> , 7.5ns)	-		e
Delay from start of internal write transaction to internal read command	t <sub>WTR</sub>	max (4t <sub>CK</sub> , 7.5ns)	-	max (4t <sub>CK</sub> , 7.5ns)	-	max (4t <sub>CK</sub> , 7.5ns)	-		e, 18
WRITE recovery time	t <sub>WR</sub>	15	-	15	-	15	-	ns	e
Mode Register Set command cycle time	t <sub>MRD</sub>	4	-	4	-	4	-	t <sub>CK(ave)</sub>	
Mode Register Set command update delay	t <sub>MOD</sub>	max (12t <sub>CK</sub> , 15ns)	-	max (12t <sub>CK</sub> , 15ns)	-	max (12t <sub>CK</sub> , 15ns)	-		
CAS# to CAS# command delay	t <sub>CCD</sub>	4	-	4	-	4	-	nCK	
Auto precharge write recovery + precharge time	t <sub>DAL(min)</sub>	WR + roundup (t <sub>RP</sub> / t <sub>CK(AVG)</sub> )						nCK	
Multi-Purpose Register Recovery Time	t <sub>MRR</sub>	1	-	1	-	1	-	nCK	
ACTIVE to PRECHARGE command period	t <sub>RAS</sub>	37.5	70,000	37.5	70,000	36	70,000	ns	e
ACTIVE to ACTIVE command period for 1KB page size	t <sub>RRD</sub>	max (4t <sub>CK</sub> , 10ns)	-	max (4t <sub>CK</sub> , 7.5ns)	-	max (4t <sub>CK</sub> , 6ns)	-		e
ACTIVE to ACTIVE command period for 2KB page size	t <sub>RRD</sub>	max (4t <sub>CK</sub> , 10ns)	-	max (4t <sub>CK</sub> , 10ns)	-	max (4t <sub>CK</sub> , 7.5ns)	-		e
Four activate window for 1KB page size	t <sub>FAW</sub>	40	-	37.5	-	30	-	ns	e
Four activate window for 2KB page size	t <sub>FAW</sub>	50	-	50	-	45	-	ns	e
Command and Address setup time to CK, $\overline{CK}$ referenced to Vih(ac) / Vil(ac) levels	t <sub>IS(base)</sub>	200	-	125	-	65	-	ps	b, 16
Command and Address hold time from CK, $\overline{CK}$ referenced to Vih(ac) / Vil(ac) levels	t <sub>IH(base)</sub>	275	-	200	-	140	-	ps	b, 16
<b>Refresh Timing</b>									
512Mb REFRESH to REFRESH OR REFRESH to ACTIVE command interval	t <sub>RFC</sub>	90	-	90	-	90	-	ns	
1Gb REFRESH to REFRESH OR REFRESH to ACTIVE command interval	t <sub>RFC</sub>	110	-	110	-	110	-	ns	
2Gb REFRESH to REFRESH OR REFRESH to ACTIVE command interval	t <sub>RFC</sub>	160	-	160	-	160	-	ns	
4Gb REFRESH to REFRESH OR REFRESH to ACTIVE command interval	t <sub>RFC</sub>	300	-	300	-	300	-	ns	
8Gb REFRESH to REFRESH OR REFRESH to ACTIVE command interval	t <sub>RFC</sub>	350	-	350	-	350	-	ns	
Average periodic refresh interval (0°C ≤ TCASE ≤ 85 °C)	t <sub>REFI</sub>	7.8		7.8		7.8		us	
Average periodic refresh interval (85°C ≤ TCASE ≤ 95 °C)	t <sub>REFI</sub>	3.9		3.9		3.9		us	
<b>Calibration Timing</b>									
Power-up and RESET calibration time	t <sub>ZQinitl</sub>	512	-	512	-	512	-	t <sub>CK</sub>	
Normal operation Full calibration time	t <sub>ZQoper</sub>	256	-	256	-	256	-	t <sub>CK</sub>	
Normal operation short calibration time	t <sub>ZQCS</sub>	64	-	64	-	64	-	t <sub>CK</sub>	23
<b>Reset Timing</b>									
Exit Reset from CK HIGH to a valid command	t <sub>XPR</sub>	max(5t <sub>CK</sub> , t <sub>RFC</sub> + 10ns)	-	max(5t <sub>CK</sub> , t <sub>RFC</sub> + 10ns)	-	max(5t <sub>CK</sub> , t <sub>RFC</sub> + 10ns)	-		
<b>Self Refresh Timing</b>									
Exit Self Refresh to commands not requiring a locked DLL	t <sub>XS</sub>	max(5t <sub>CK</sub> , t <sub>RFC</sub> + 10ns)	-	max(5t <sub>CK</sub> , t <sub>RFC</sub> + 10ns)	-	max(5t <sub>CK</sub> , t <sub>RFC</sub> + 10ns)	-		
Exit Self Refresh to commands requiring a locked DLL	t <sub>XSDLL</sub>	t <sub>DLLK(min)</sub>	-	t <sub>DLLK(min)</sub>	-	t <sub>DLLK(min)</sub>	-	t <sub>CK</sub>	
Minimum CKE low width for Self refresh entry to exit timing	t <sub>CKESR</sub>	t <sub>CKE(min)</sub> + 1t <sub>CK</sub>	-	t <sub>CKE(min)</sub> + 1t <sub>CK</sub>	-	t <sub>CKE(min)</sub> + 1t <sub>CK</sub>	-		
Valid Clock Requirement after Self Refresh Entry (SRE)	t <sub>CKSRE</sub>	max(5t <sub>CK</sub> , 10ns)	-	max(5t <sub>CK</sub> , 10ns)	-	max(5t <sub>CK</sub> , 10ns)	-		
Valid Clock Requirement before Self Refresh Exit (SRX)	t <sub>CKSRX</sub>	max(5t <sub>CK</sub> , 10ns)	-	max(5t <sub>CK</sub> , 10ns)	-	max(5t <sub>CK</sub> , 10ns)	-		

[ Table 51 ] Timing Parameters by Speed Bin (Cont.)

Speed		DDR3-800		DDR3-1066		DDR3-1333		Units	Note
Parameter	Symbol	MIN	MAX	MIN	MAX	MIN	MAX		
<b>Power Down Timing</b>									
Exit Power Down with DLL on to any valid command; Exit Precharge Power Down with DLL frozen to commands not requiring a locked DLL	$t_{XP}$	max ( $3t_{CK}, 7.5ns$ )	-	max ( $3t_{CK}, 7.5ns$ )	-	max ( $3t_{CK}, 6ns$ )	-		
Exit Precharge Power Down with DLL frozen to commands requiring a locked DLL	$t_{XPDLL}$	max ( $10t_{CK}, 24ns$ )	-	max ( $10t_{CK}, 24ns$ )	-	max ( $10t_{CK}, 24ns$ )	-		2
CKE minimum pulse width	$t_{CKE}$	max ( $3t_{CK}, 7.5ns$ )	-	max ( $3t_{CK}, 5.625ns$ )	-	max ( $3t_{CK}, 5.625ns$ )	-		
Command pass disable delay	$t_{CPDED}$	1	-	1	-	1	-	nCK	
Power Down Entry to Exit Timing	$t_{PD}$	$t_{CKE}(min)$	$9 \cdot t_{REFI}$	$t_{CKE}(min)$	$9 \cdot t_{REFI}$	$t_{CKE}(min)$	$9 \cdot t_{REFI}$	$t_{CK}$	15
Timing of ACT command to Power Down entry	$t_{ACTPDEN}$	1	-	1	-	1	-	nCK	20
Timing of PRE command to Power Down entry	$t_{PRPDEN}$	1	-	1	-	1	-	nCK	20
Timing of RD/RDA command to Power Down entry	$t_{RDPDEN}$	RL + 4 + 1	-	RL + 4 + 1	-	RL + 4 + 1	-		
Timing of WR command to Power Down entry (BL8OTF, BL8MRS, BL4OTF)	$t_{WRPDEN}$	WL + 4 + ( $t_{WR}/t_{CK}$ )	-	WL + 4 + ( $t_{WR}/t_{CK}$ )	-	WL + 4 + ( $t_{WR}/t_{CK}$ )	-	nCK	9
Timing of WRA command to Power Down entry (BL8OTF, BL8MRS, BL4OTF)	$t_{WRAPDEN}$	WL + 4 + WR + 1	-	WL + 4 + WR + 1	-	WL + 4 + WR + 1	-	nCK	10
Timing of WR command to Power Down entry (BL4MRS)	$t_{WRPDEN}$	WL + 2 + ( $t_{WR}/t_{CK}$ )	-	WL + 2 + ( $t_{WR}/t_{CK}$ )	-	WL + 2 + ( $t_{WR}/t_{CK}$ )	-	nCK	9
Timing of WRA command to Power Down entry (BL4MRS)	$t_{WRAPDEN}$	WL + 2 + WR + 1	-	WL + 2 + WR + 1	-	WL + 2 + WR + 1	-	nCK	10
Timing of REF command to Power Down entry	$t_{REFPDEN}$	1	-	1	-	1	-		20,21
Timing of MRS command to Power Down entry	$t_{MRSPDEN}$	$t_{MOD}(min)$	-	$t_{MOD}(min)$	-	$t_{MOD}(min)$	-	$t_{CK}$	
<b>ODT Timing</b>									
ODT high time without write command or with write command and BC4	ODTH4	4	-	4	-	4	-	nCK	
ODT high time with Write command and BL8	ODTH8	6	-	6	-	6	-	nCK	
Asynchronous RTT turn-on delay (Power-Down with DLL frozen)	$t_{AONPD}$	1	9	1	9	1	9	ns	
Asynchronous RTT turn-off delay (Power-Down with DLL frozen)	$t_{AOFPD}$	1	9	1	9	1	9	ns	
ODT turn-on	$t_{AON}$	-400	400	-300	30	-250	250	ps	7,12
RTT_NOM and RTT_WR turn-off time from ODTLoff reference	$t_{AOF}$	0.3	0.7	0.3	0.7	0.3	0.7	$t_{CK}(avg)$	8,12
RTT dynamic change skew	$t_{ADC}$	0.3	0.7	0.3	0.7	0.3	0.7	$t_{CK}(avg)$	12
<b>Write Leveling Timing</b>									
First DQS pulse rising edge after tDQSS margining mode is programmed	$t_{WLMRD}$	40	-	40	-	40	-	$t_{CK}$	3
DQS/DQS delay after tDQS margining mode is programmed	$t_{WLDQSEN}$	25	-	25	-	25	-	$t_{CK}$	3
Setup time for tDQSS latch	$t_{WLS}$	325	-	245	-	195	-	ps	
Hold time of tDQSS latch	$t_{WLH}$	325	-	245	-	195	-	ps	
Write leveling output delay	$t_{WLO}$	0	9	0	9	0	9	ns	
Write leveling output error	$t_{WLOE}$	0	2	0	2	0	2	ns	

## Jitter Notes

### Specific Note a

When the device is operated with input clock jitter, this parameter needs to be derated by the actual  $tERR(mper),act$  of the input clock, where  $2 \leq m \leq 12$ . (output deratings are relative to the SDRAM input clock.)

For example, if the measured jitter into a DDR3-800 SDRAM has  $tERR(mper),act,min = -172$  ps and  $tERR(mper),act,max = +193$  ps, then  $tDQSCK,min(derated) = tDQSCK,min - tERR(mper),act,max = -400$  ps - 193 ps = -593 ps and  $tDQSCK,max(derated) = tDQSCK,max - tERR(mper),act,min = 400$  ps + 172 ps = +572 ps. Similarly,  $tLZ(DQ)$  for DDR3-800 derates to  $tLZ(DQ),min(derated) = -800$  ps - 193 ps = -993 ps and  $tLZ(DQ),max(derated) = 400$  ps + 172 ps = +572 ps. (Caution on the min/max usage!)

Note that  $tERR(mper),act,min$  is the minimum measured value of  $tERR(nper)$  where  $2 \leq n \leq 12$ , and  $tERR(mper),act,max$  is the maximum measured value of  $tERR(nper)$  where  $2 \leq n \leq 12$ .

### Specific Note b

When the device is operated with input clock jitter, this parameter needs to be derated by the actual  $tJIT(per),act$  of the input clock. (output deratings are relative to the SDRAM input clock.)

For example, if the measured jitter into a DDR3-800 SDRAM has  $tCK(avg),act = 2500$  ps,  $tJIT(per),act,min = -72$  ps and  $tJIT(per),act,max = +93$  ps, then  $tRPRE,min(derated) = tRPRE,min + tJIT(per),act,min = 0.9 \times tCK(avg),act + tJIT(per),act,min = 0.9 \times 2500$  ps - 72 ps = +2178 ps. Similarly,  $tQH,min(derated) = tQH,min + tJIT(per),act,min = 0.38 \times tCK(avg),act + tJIT(per),act,min = 0.38 \times 2500$  ps - 72 ps = +878 ps. (Caution on the min/max usage!)

### Specific Note c

These parameters are measured from a data strobe signal ( $DQS(L/U)$ ,  $\overline{DQS}(L/U)$ ) crossing to its respective clock signal ( $CK$ ,  $\overline{CK}$ ) crossing. The spec values are not affected by the amount of clock jitter applied (i.e.  $tJIT(per)$ ,  $tJIT(cc)$ , etc.), as these are relative to the clock signal crossing.

That is, these parameters should be met whether clock jitter is present or not.

### Specific Note d

These parameters are measured from a data signal ( $DM(L/U)$ ,  $DQ(L/U)0$ ,  $DQ(L/U)1$ , etc.) transition edge to its respective data strobe signal ( $DQS(L/U)$ ,  $\overline{DQS}(L/U)$ ) crossing.

### Specific Note e

For these parameters, the DDR3 SDRAM device supports  $tnPARAM [nCK] = RU\{ tPARAM [ns] / tCK(avg) [ns] \}$ , which is in clock cycles, assuming all input clock jitter specifications are satisfied.

For example, the device will support  $tnRP = RU\{tRP / tCK(avg)\}$ , which is in clock cycles, if all input clock jitter specifications are met. This means: For DDR3-800 6-6-6, of which  $tRP = 15$ ns, the device will support  $tnRP = RU\{tRP / tCK(avg)\} = 6$ , as long as the input clock jitter specifications are met, i.e. Precharge command at  $Tm$  and Active command at  $Tm+6$  is valid even if  $(Tm+6 - Tm)$  is less than 15ns due to input clock jitter.

## Timing Parameter Notes

1. Actual value dependant upon measurement level definitions which are TBD.
  2. Commands requiring a locked DLL are: READ (and RAP) and synchronous ODT commands.
  3. The max values are system dependent.
  4. WR as programmed in mode register
  5. Value must be rounded-up to next higher integer value
  6. There is no maximum cycle time limit besides the need to satisfy the refresh interval, tREFI.
  7. For definition of RTT turn-on time tAON see "Device Operation"
  8. For definition of RTT turn-off time tAOF see "Device Operation".
  9. tWR is defined in ns, for calculation of tWRPDEN it is necessary to round up tWR / tCK to the next integer.
  10. WR in clock cycles as programmed in MR0
  11. The maximum postamble is bound by tHZDQS(max)
  12. Output timing deratings are relative to the SDRAM input clock. When the device is operated with input clock jitter, this parameter needs to be derated by TBD
  13. Value is only valid for RON34
  14. Single ended signal parameter. Refer to chapter <TBD> for definition and measurement method.
  15. tREFI depends on TOPER
  16. tIS(base) and tIH(base) values are for 1V/ns CMD/ADD single-ended slew rate and 2V/ns CK,  $\overline{\text{CK}}$  differential slew rate, Note for DQ and DM signals, VREF(DC) = VrefDQ(DC). For input only pins except RESET, VRef(DC)=VRefCA(DC). See "Address/ Command Setup, Hold and Derating" on page 53.
  17. tDS(base) and tDH(base) values are for 1V/ns DQ single-ended slew rate and 2V/ns DQS,  $\overline{\text{DQS}}$  differential slew rate. Note for DQ and DM signals, VREF(DC)= VrefDQ(DC). For input only pins except RESET, VRef(DC)=VRefCA(DC). See "Data Setup, Hold and Slew Rate Derating" on page 59.
  18. Start of internal write transaction is defined as follows ;  
For BL8 (fixed by MRS and on-the-fly) : Rising clock edge 4 clock cycles after WL.  
For BC4 (on-the-fly) : Rising clock edge 4 clock cycles after WL  
For BC4 (fixed by MRS) : Rising clock edge 2 clock cycles after WL
  19. The maximum preamble is bound by tLZDQS(max)
  20. CKE is allowed to be registered low while operations such as row activation, precharge, autoprecharge or refresh are in progress, but power-down IDD spec will not be applied until finishing those operations.
  21. Although CKE is allowed to be registered LOW after a REFRESH command once tREFPDEN(min) is satisfied, there are cases where additional time such as tXPDLL(min) is also required. See "Device Operation".
  22. Defined between end of MPR read burst and MRS which reloads MPR or disables MPR function.
  23. One ZQCS command can effectively correct a minimum of 0.5 % (ZQCorrection) of RON and RTT impedance error within 64 nCK for all speed bins assuming the maximum sensitivities specified in the 'Output Driver Voltage and Temperature Sensitivity' and 'ODT Voltage and Temperature Sensitivity' tables. The appropriate interval between ZQCS commands can be determined from these tables and other applicationspecific One method for calculating the interval between ZQCS commands, given the temperature (Tdriftrate) and voltage (Vdriftrate) drift rates that the SDRAM is subject to in the application, is illustrated. The interval could be defined by the following formula:  

$$\frac{\text{ZQCorrection}}{(\text{TSens} \times \text{Tdriftrate}) + (\text{VSens} \times \text{Vdriftrate})}$$
- where TSens = max(dRTTdT, dRONdTM) and VSens = max(dRTTdV, dRONdVM) For example, if TSens = 1.5% /°C, VSens = 0.15% / mV, Tdriftrate = 1°C / sec and Vdriftrate = 15 mV / sec, then the interval between ZQCS commands is calculated as:
- $$\frac{0.5}{(1.5 \times 1) + (0.15 \times 15)} = 0.133 \approx 128\text{ms}$$
24. n = from 13 cycles to 50 cycles. This row defines 38 parameters.
  25. tCH(abs) is the absolute instantaneous clock high pulse width, as measured from one rising edge to the following falling edge.
  26. tCL(abs) is the absolute instantaneous clock low pulse width, as measured from one falling edge to the following rising edge.
  27. The tIS(base) AC150 specifications are adjusted from the tIS(base) specification by adding an additional 100 ps of derating to accommodate for the lower alternate threshold of 150 mV and another 25 ps to account for the earlier reference point [(175 mv - 150 mV) / 1 V/ns].

**Address / Command Setup, Hold and Derating:**

For all input signals the total tIS (setup time) and tIH (hold time) required is calculated by adding the data sheet tIS(base) and tIH(base) value (see Table 53) to the ΔtIS and ΔtIH derating value (see Table 54) respectively.

Example: tIS (total setup time) = tIS(base) + ΔtIS Setup (tIS) nominal slew rate for a rising signal is defined as the slew rate between the last crossing of VREF(dc) and the first crossing of VIH(ac)min. Setup (tIS) nominal slew rate for a falling signal is defined as the slew rate between the last crossing of VREF(dc) and the first crossing of Vil(ac)max. If the actual signal is always earlier than the nominal slew rate line between shaded 'VREF(dc) to ac region', use nominal slew rate for derating value (see Figure 23). If the actual signal is later than the nominal slew rate line anywhere between shaded 'VREF(dc) to ac region', the slew rate of a tangent line to the actual signal from the ac level to dc level is used for derating value (see Figure 25).

Hold (tIH) nominal slew rate for a rising signal is defined as the slew rate between the last crossing of Vil(dc)max and the first crossing of VREF(dc). Hold (tIH) nominal slew rate for a falling signal is defined as the slew rate between the last crossing of Vih(dc)min and the first crossing of VREF(dc). If the actual signal is always later than the nominal slew rate line between shaded 'dc to VREF(dc) region', use nominal slew rate for derating value (see Figure 24). If the actual signal is earlier than the nominal slew rate line anywhere between shaded 'dc to VREF(dc) region', the slew rate of a tangent line to the actual signal from the dc level to VREF(dc) level is used for derating value (see Figure 26).

For a valid transition the input signal has to remain above/below VIH/IL(ac) for some time tVAC (see Table 55).

Although for slow slew rates the total setup time might be negative (i.e. a valid input signal will not have reached VIH/IL(ac) at the time of the rising clock transition) a valid input signal is still required to complete the transition and reach VIH/IL(ac).

For slew rates in between the values listed in Table 54, the derating values may obtained by linear interpolation.

These values are typically not subject to production test. They are verified by design and characterization.

[ Table 53 ] ADD/CMD Setup and Hold Base-Values for 1V/ns

[ps]	DDR3-800	DDR3-1066	DDR3-1333	DDR3-1600	reference
tIS(base)	200	125	65	TBD	VIH/L(ac)
tIH(base)	275	200	140	TBD	VIH/L(dc)
tIS(base)-AC150	-	-	65+125	TBD+125	VIH/L(ac)

**Note :** AC/DC referenced for 1V/ns DQ-slew rate and 2V/ns DQS slew rate

**Note :** The tIS(base)-AC150 specifications are further adjusted to add an additional 100ps of derating to accommodate for the lower alternate threshold of 150mV and another 25ps to account for the earlier reference point [(175mv-150mV)/1 V/ns].

[ Table 54 ] Derating values DDR3-800/1066 tIS/tIH-ac/dc based

ΔtIS, ΔtIH Derating [ps] AC/DC based AC175 Threshold -> VIH(ac) = VREF(dc) + 175mV, VIL(ac) = VREF(dc) - 175mV																	
		CLK,CLK Differential Slew Rate															
		4.0 V/ns		3.0 V/ns		2.0 V/ns		1.8 V/ns		1.6 V/ns		1.4V/ns		1.2V/ns		1.0V/ns	
		ΔtIS	ΔtIH	ΔtIS	ΔtIH	ΔtIS	ΔtIH	ΔtIS	ΔtIH	ΔtIS	ΔtIH	ΔtIS	ΔtIH	ΔtIS	ΔtIH	ΔtIS	ΔtIH
CMD/ ADD Slew rate V/ns	2.0	88	50	88	50	88	50	96	58	104	66	112	74	120	84	128	100
	1.5	59	34	59	34	59	34	67	42	75	50	83	58	91	68	99	74
	1.0	0	0	0	0	0	0	8	8	16	16	24	24	32	34	40	50
	0.9	-2	-4	-2	-4	-2	-4	6	4	14	12	20	20	30	30	38	46
	0.8	-6	-10	-6	-10	-6	-10	2	-2	10	6	13	14	26	24	34	40
	0.7	-11	-16	-11	-16	-11	-16	-3	-8	5	0	13	8	21	18	29	34
	0.6	-17	-26	-17	-26	-17	-26	-9	-18	-1	-10	7	-2	15	8	23	24
	0.5	-35	-40	-35	-40	-35	-40	-27	-32	-19	-24	-11	-16	-2	-6	6	10
	0.4	-62	-60	-62	-60	-60	-60	-54	-52	-46	-44	-38	-36	-30	-26	-22	-10

[ Table 55 ] Derating values DDR3-1333/1600 tIS/tIH-ac/dc based - Alternate AC150 Threshold

ΔtIS, ΔtIH Derating [ps] AC/DC based Alternate AC150 Threshold -> VIH(ac) = VREF(dc) + 150mV, VIL(ac) = VREF(dc) - 150mV																	
		CLK,CLK Differential Slew Rate															
		4.0 V/ns		3.0 V/ns		2.0 V/ns		1.8 V/ns		1.6 V/ns		1.4V/ns		1.2V/ns		1.0V/ns	
		ΔtIS	ΔtIH	ΔtIS	ΔtIH	ΔtIS	ΔtIH	ΔtIS	ΔtIH	ΔtIS	ΔtIH	ΔtIS	ΔtIH	ΔtIS	ΔtIH	ΔtIS	ΔtIH
CMD/ ADD Slew rate V/ns	2.0	70	50	75	50	75	50	83	58	91	66	99	74	107	84	115	100
	1.5	50	34	50	34	50	34	58	42	66	50	74	58	82	68	90	84
	1.0	0	0	0	0	0	0	8	8	16	16	24	24	32	34	40	50
	0.9	0	-4	0	-4	0	-4	8	4	16	12	24	20	32	30	40	46
	0.8	0	-10	0	-10	0	-10	8	-2	16	6	24	14	32	24	40	40
	0.7	0	-16	0	-16	0	-16	8	-8	16	0	24	8	32	18	40	34
	0.6	-1	-26	-1	-26	-1	-26	7	-18	15	-10	23	-2	31	8	39	24
	0.5	-10	-40	-10	-40	-10	-40	-2	-32	6	-24	14	-16	22	-6	30	10
	0.4	-25	-60	-25	-60	-25	-60	-17	-52	-9	-44	-1	-36	7	-26	15	-10

[ Table 56 ] Required time tVAC above VIH(ac) {blow VIL(ac)} for valid transition

Slew Rate[V/ns]	tVAC @175mV [ps]		tVAC @50mV [ps]	
	min	max	min	max
>2.0	75	-	175	-
2.0	57	-	170	-
1.5	50	-	167	-
1.0	38	-	163	-
0.9	34	-	162	-
0.8	29	-	161	-
0.7	22	-	159	-
0.6	13	-	155	-
0.5	0	-	150	-
< 0.5	0	-	150	-

Note :Clock and Strobe are drawn on a different time scale.

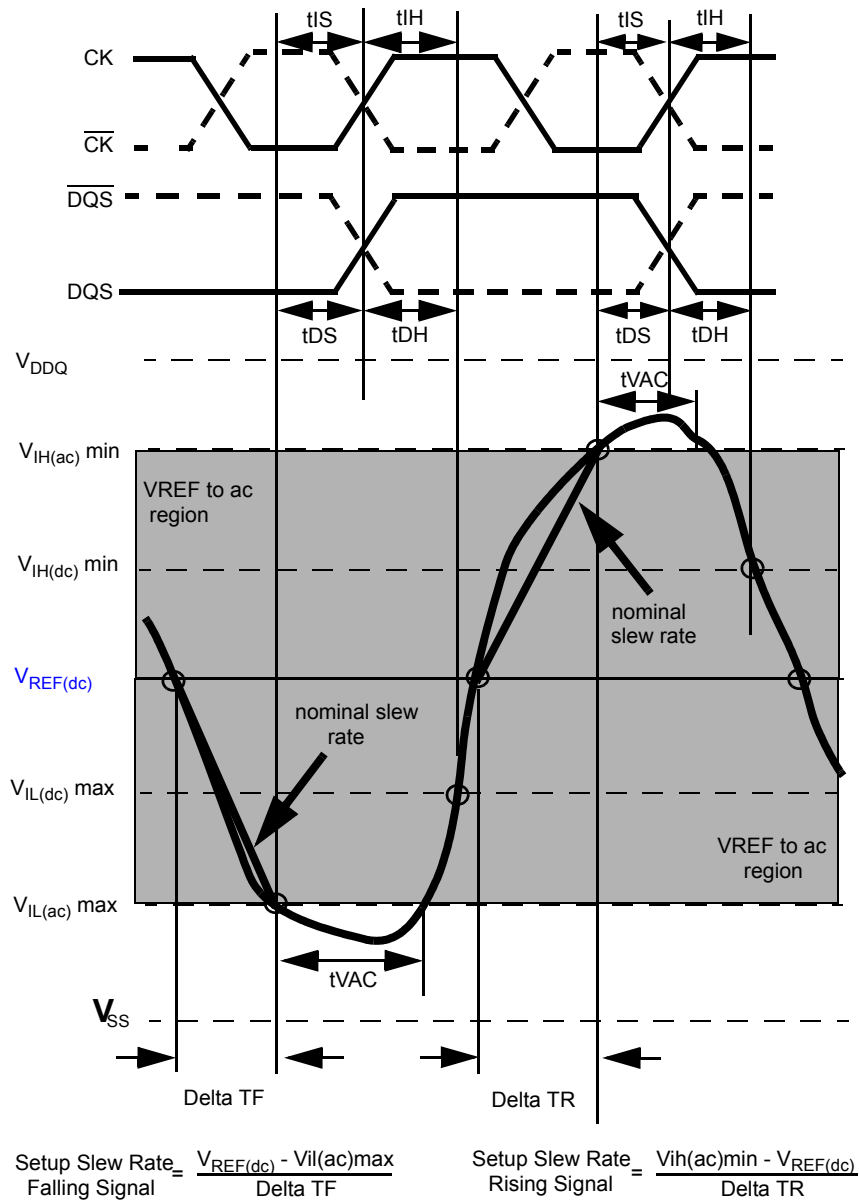

Figure 21 - Illustration of nominal slew rate and tVAC for setup time tDS (for DQ with respect to strobe) and tIS (for ADD/CMD with respect to clock).

Note :Clock and Strobe are drawn on a different time scale.

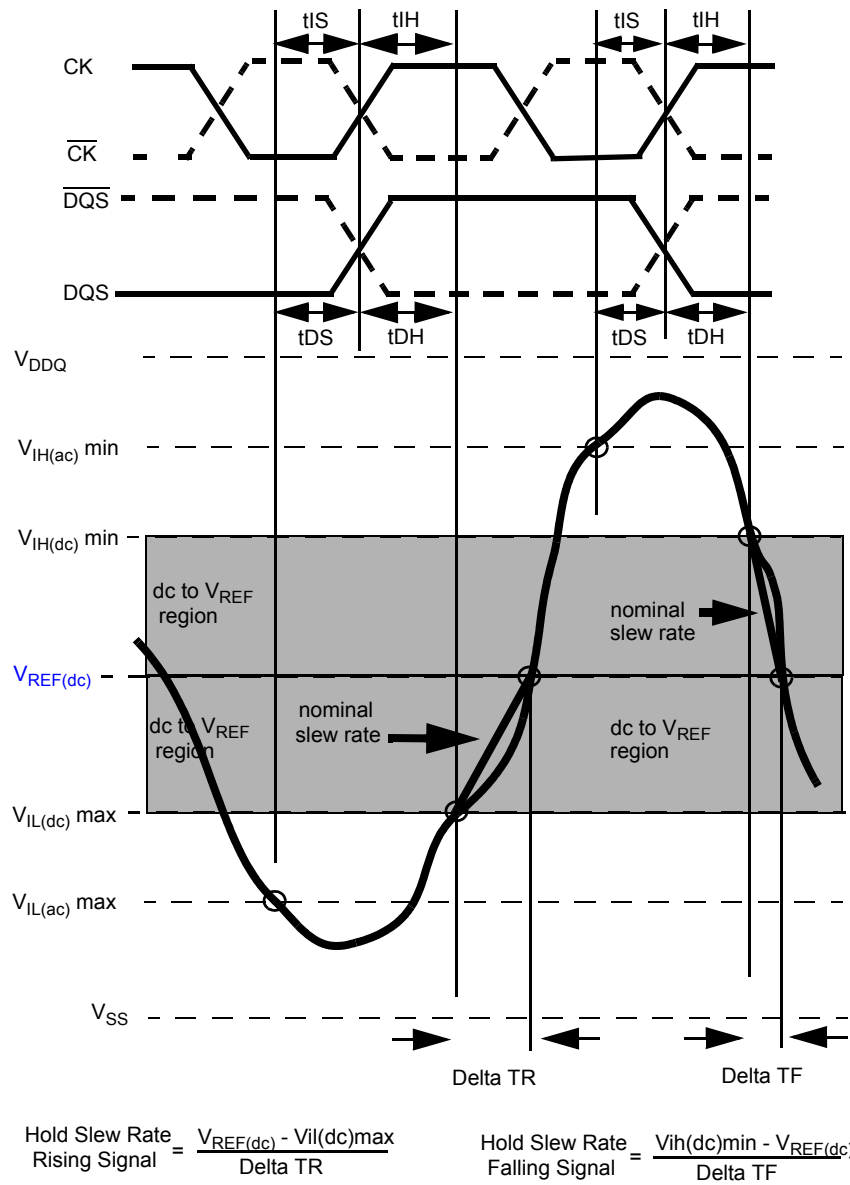

Figure 22 - Illustration of nominal slew rate for hold time tDH (for DQ with respect to strobe) and tIH (for ADD/CMD with respect to clock).



Note :Clock and Strobe are drawn on a different time scale.

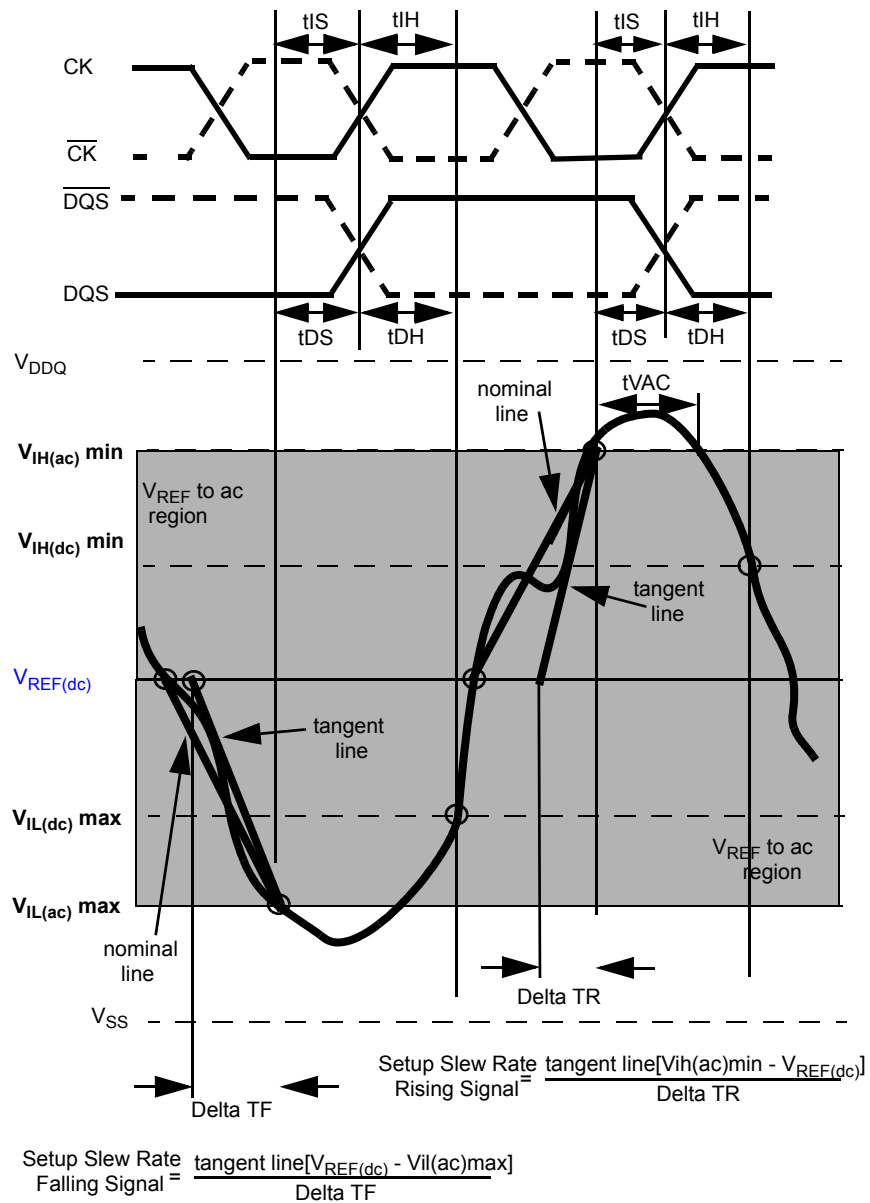

Figure 23. Illustration of tangent line for setup time t<sub>DS</sub> (for DQ with respect to strobe) and t<sub>IS</sub> (for ADD/CMD with respect to clock)

Note :Clock and Strobe are drawn on a different time scale.

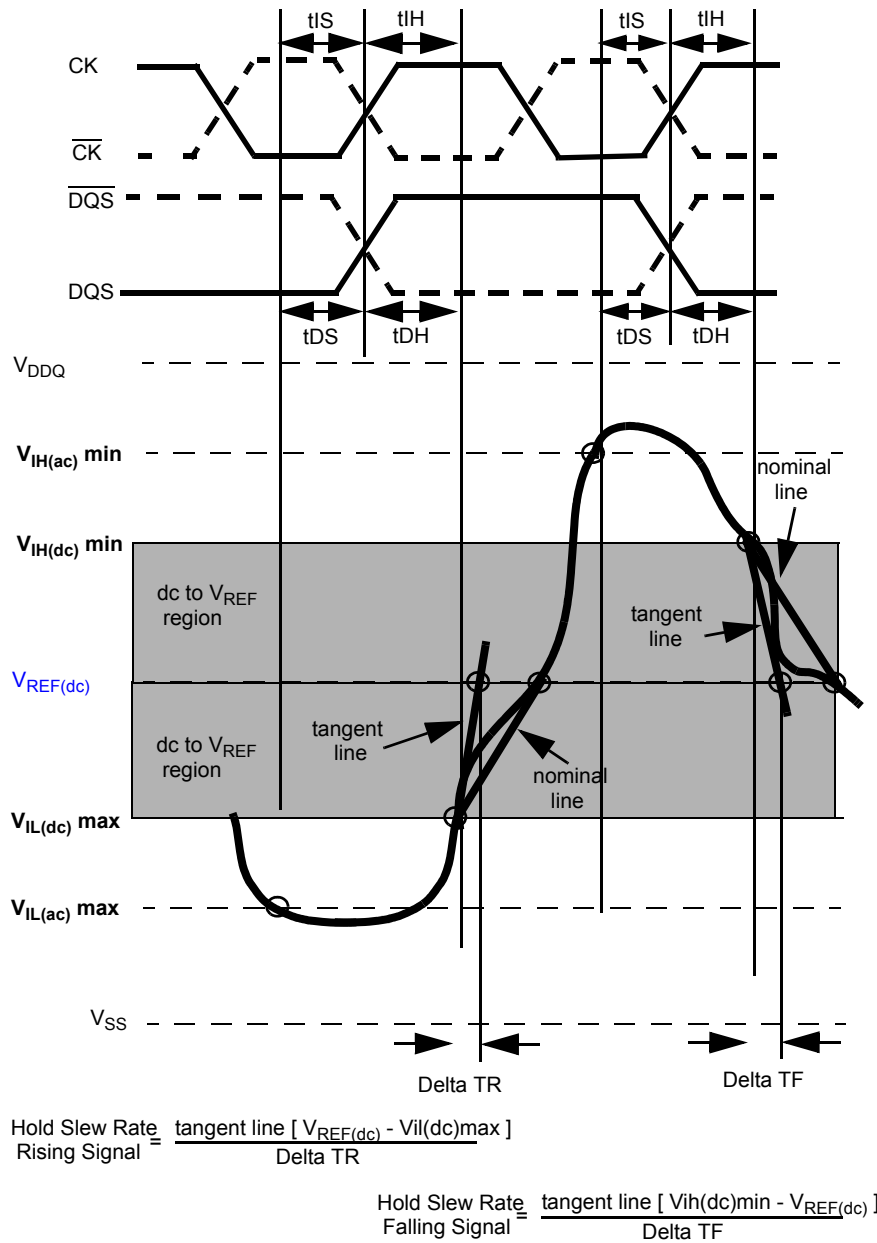

Figure 24 - Illustration of tangent line for hold time tDH (for DQ with respect to strobe) and tIH (for ADD/CMD with respect to clock)

**Data Setup, Hold and Slew Rate Derating:**

For all input signals the total tDS (setup time) and tDH (hold time) required is calculated by adding the data sheet tDS(base) and tDH(base) value (see Table 57) to the ΔtDS and ΔtDH (see Table 58) derating value respectively. Example: tDS (total setup time) = tDS(base) + ΔtDS.

Setup (tDS) nominal slew rate for a rising signal is defined as the slew rate between the last crossing of VREF(dc) and the first crossing of VIH(ac)min. Setup (tDS) nominal slew rate for a falling signal is defined as the slew rate between the last crossing of VREF(dc) and the first crossing of VIL(ac)max (see Figure 27). If the actual signal is always earlier than the nominal slew rate line between shaded 'VREF(dc) to ac region', use nominal slew rate for derating value. If the actual signal is later than the nominal slew rate line anywhere between shaded 'VREF(dc) to ac region', the slew rate of a tangent line to the actual signal from the ac level to dc level is used for derating value (see Figure 29).

Hold (tDH) nominal slew rate for a rising signal is defined as the slew rate between the last crossing of VIL(dc)max and the first crossing of VREF(dc). Hold (tDH) nominal slew rate for a falling signal is defined as the slew rate between the last crossing of VIH(dc)min and the first crossing of VREF(dc) (see Figure 28). If the actual signal is always later than the nominal slew rate line between shaded 'dc level to VREF(dc) region', use nominal slew rate for derating value. If the actual signal is earlier than the nominal slew rate line anywhere between shaded 'dc to VREF(dc) region', the slew rate of a tangent line to the actual signal from the dc level to VREF(dc) level is used for derating value (see Figure 30).

For a valid transition the input signal has to remain above/below VIH/IL(ac) for some time tVAC (see Table 59).

Although for slow slew rates the total setup time might be negative (i.e. a valid input signal will not have reached VIH/IL(ac) at the time of the rising clock transition) a valid input signal is still required to complete the transition and reach VIH/IL(ac).

For slew rates in between the values listed in the tables the derating values may be obtained by linear interpolation. These values are typically not subject to production test. They are verified by design and characterization

[ Table 57 ] Data Setup and Hold Base-Value

[ps]	DDR3-800	DDR3-1066	DDR3-1333	DDR3-1600	reference
tDS(base)	75	25	-10	TBD	VIH/L(ac)
tDH(base)	150	100	65	TBD	VIH/L(dc)

Note : AC/DC referenced for 1V/ns DQ-slew rate and 2 V/ns DQS slew rate)

[ Table 58 ] Derating values DDR3-800/1066 tIS/tIH-ac/dc based

ΔtDS, ΔtDH Derating [ps] AC/DC based <sup>a</sup>																	
		DQS,DQS Differential Slew Rate															
		4.0 V/ns		3.0 V/ns		2.0 V/ns		1.8 V/ns		1.6 V/ns		1.4V/ns		1.2V/ns		1.0V/ns	
		ΔtDS	ΔtDH	ΔtDS	ΔtDH	ΔtDS	ΔtDH	ΔtDS	ΔtDH	ΔtDS	ΔtDH	ΔtDS	ΔtDH	ΔtDS	ΔtDH	ΔtDS	ΔtDH
DQ Slew rate V/ns	2.0	88	50	88	50	88	50	-	-	-	-	-	-	-	-	-	-
	1.5	59	34	59	34	59	34	67	45	-	-	-	-	-	-	-	-
	1.0	0	0	0	0	0	0	8	8	16	16	-	-	-	-	-	-
	0.9	-	-	-2	-4	-2	-4	6	4	14	12	22	20	-	-	-	-
	0.8	-	-	-	-	-6	-10	2	-2	10	6	18	14	26	24	-	-
	0.7	-	-	-	-	-	-	-3	-8	5	0	13	8	21	18	29	34
	0.6	-	-	-	-	-	-	-	-	-1	-10	7	-2	15	8	23	24
	0.5	-	-	-	-	-	-	-	-	-	-	-11	-16	-2	-6	6	10
	0.4	-	-	-	-	-	-	-	-	-	-	-	-	-30	-26	-22	-10

Note : a. Cell contents shaded in red are defined as 'not supported'.

[ Table 59 ] Required time tVAC above VIH(ac) {blow VIL(ac)} for valid transition

Slew Rate[V/ns]	tVAC[ps]	
	min	max
>2.0	75	-
2.0	57	-
1.5	50	-
1.0	38	-
0.9	34	-
0.8	29	-
0.7	22	-
0.6	13	-
0.5	0	-
<0.5	0	-

Note :Clock and Strobe are drawn on a different time scale.

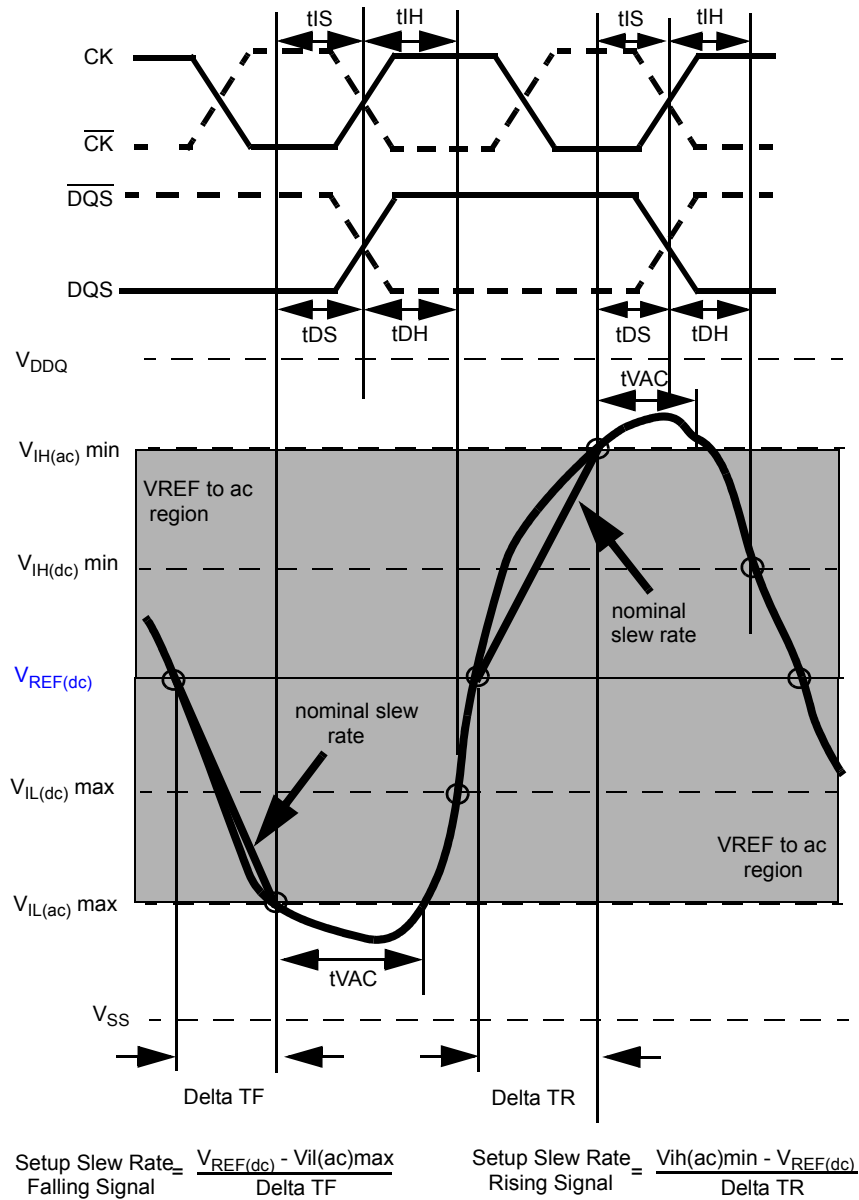

Figure 27 - Illustration of nominal slew rate and tVAC for setup time tDS (for DQ with respect to strobe) and tIS (for ADD/CMD with respect to clock).

Note :Clock and Strobe are drawn on a different time scale.

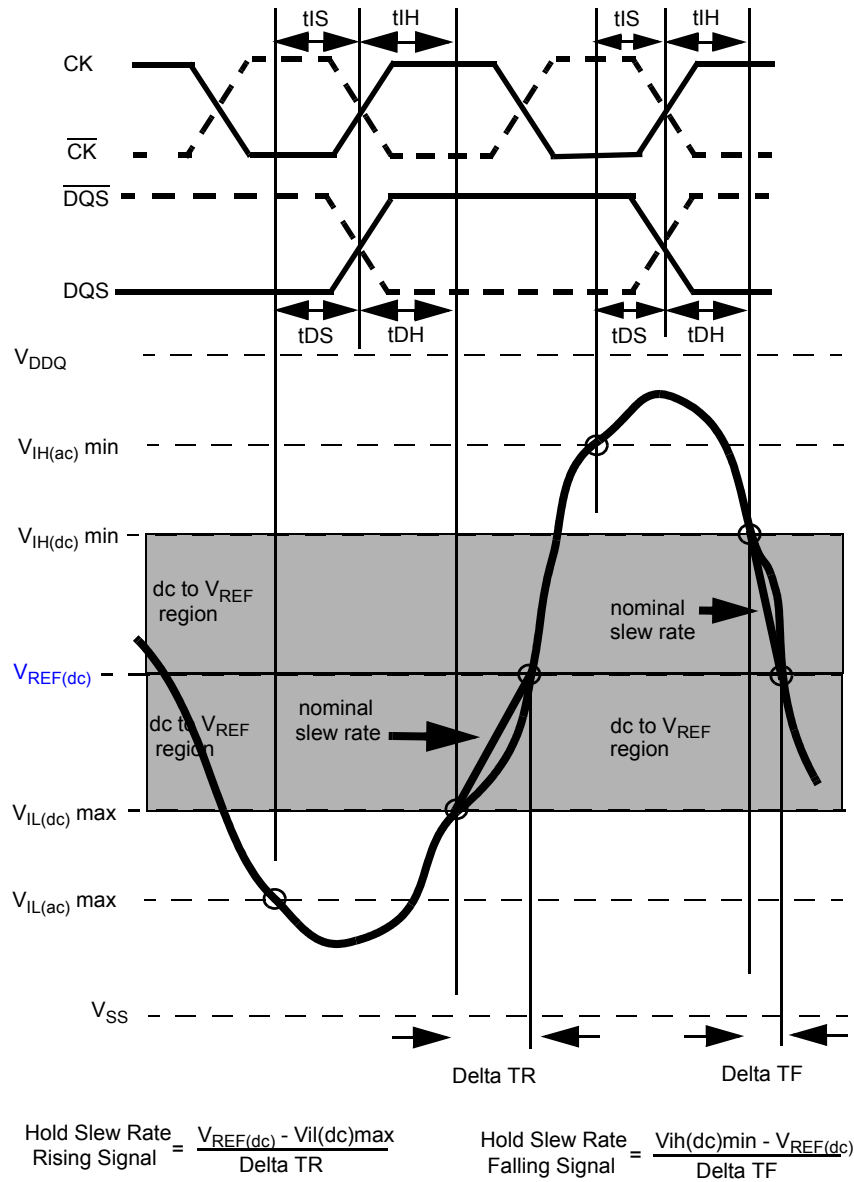

Figure 28 - Illustration of nominal slew rate for hold time tDH (for DQ with respect to strobe) and tIH (for ADD/CMD with respect to clock).

Note :Clock and Strobe are drawn on a different time scale.

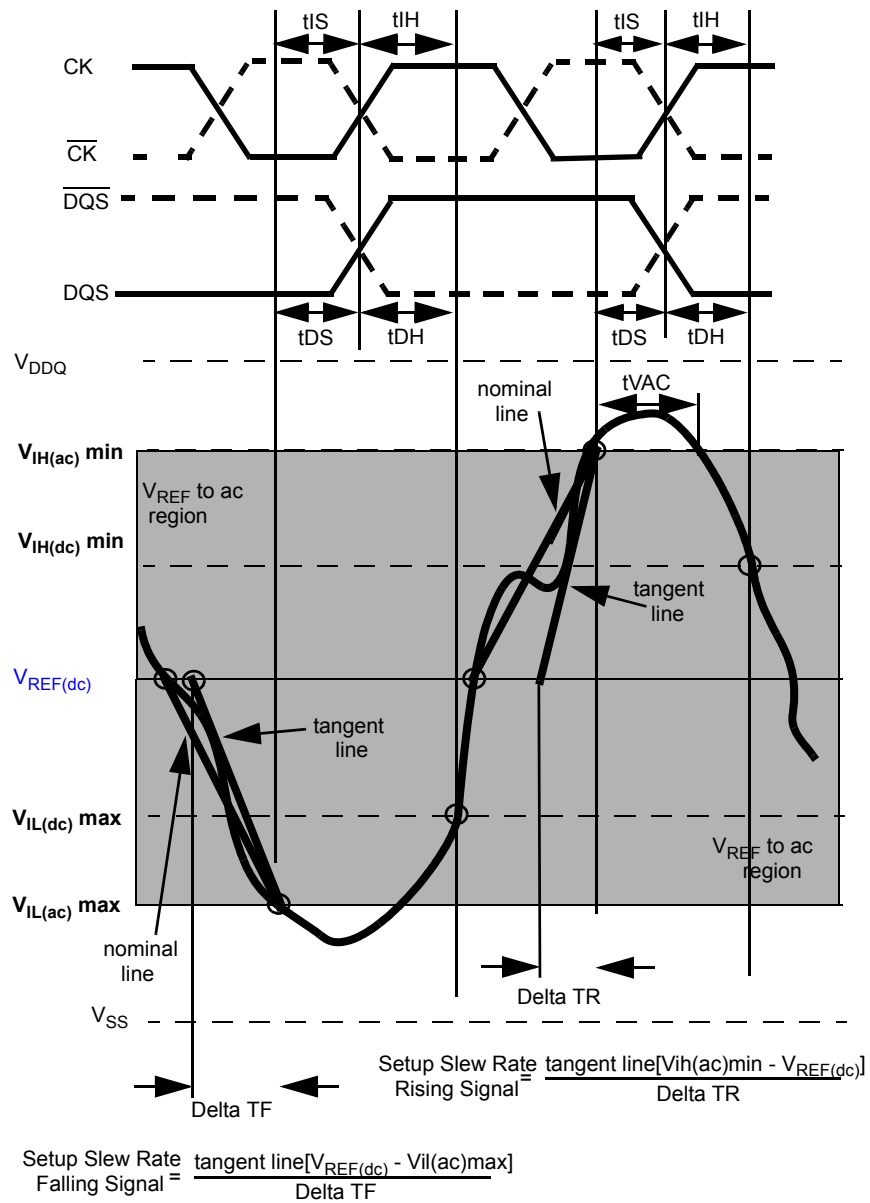

Figure 29 - Illustration of tangent line for setup time  $t_{DS}$  (for DQ with respect to strobe) and  $t_{IS}$  (for ADD/CMD with respect to clock)

Note :Clock and Strobe are drawn on a different time scale.

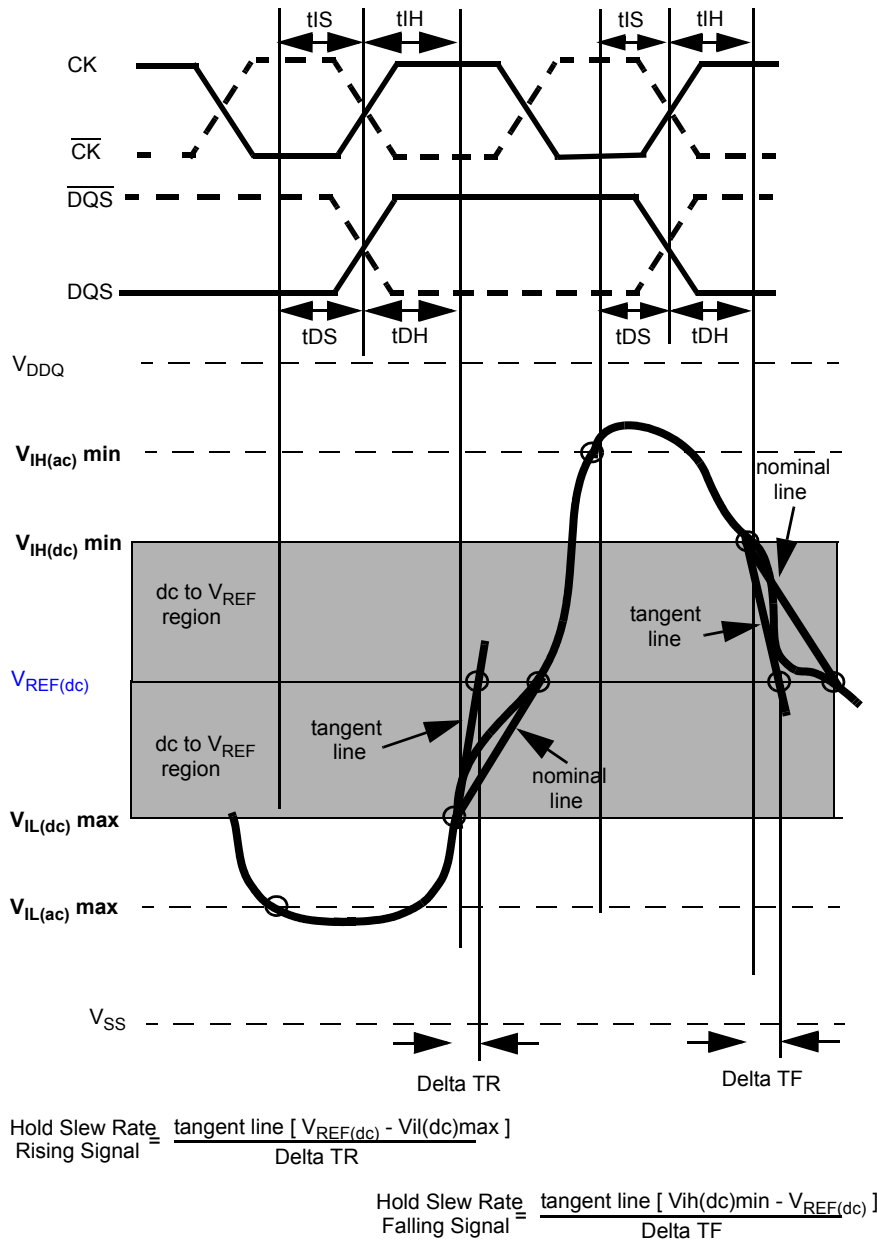

Figure 30 - Illustration of tangent line for hold time tDH (for DQ with respect to strobe) and tIH (for ADD/CMD with respect to clock)