

PNP Epitaxial Silicon Transistor

STATIC CHARACTERISTIC

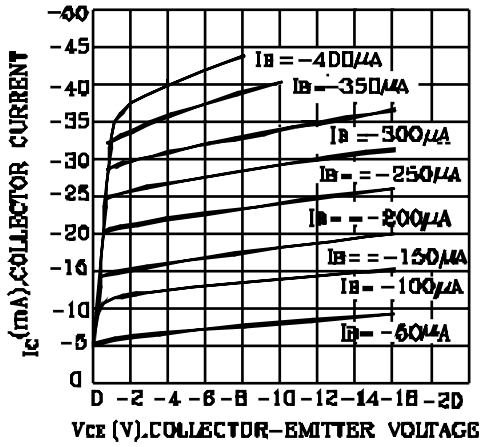

BASE-EMITTER VOLTAGE

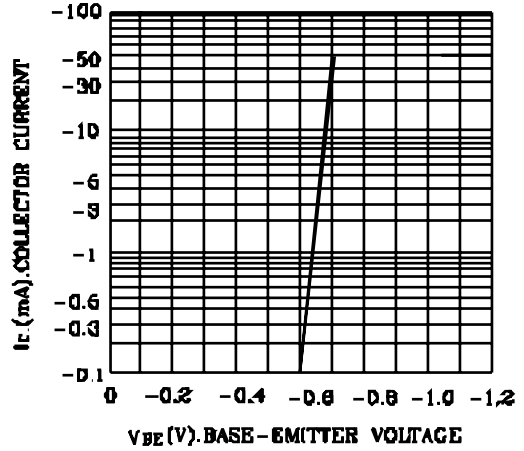

DC CURRENT GAIN

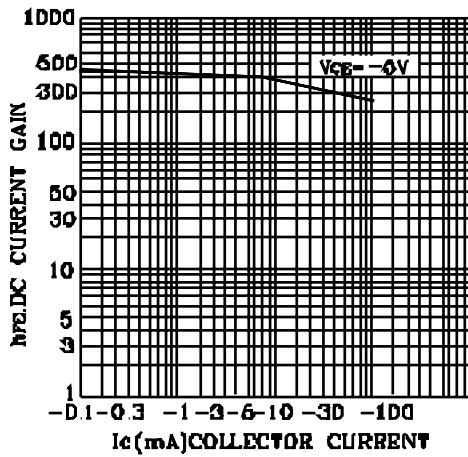

CURRENT GAIN-BANDWIDTH PRODUCT

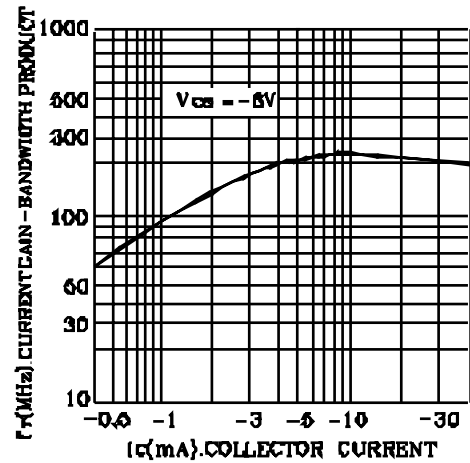

BASE-EMITTER SATURATION VOLTAGE
COLLECTOR-EMITTER SATURATION VOLTAGE

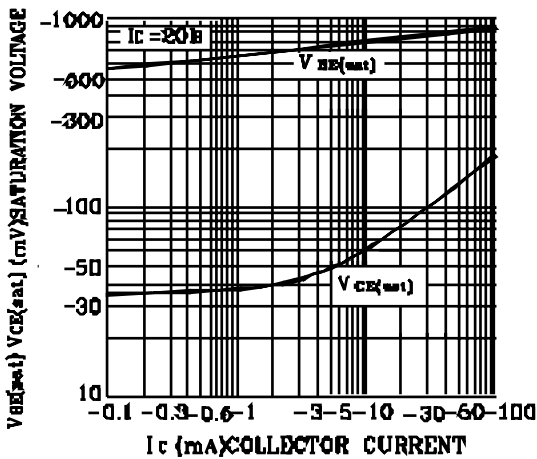

COLLECTOR OUTPUT CAPACITANCE

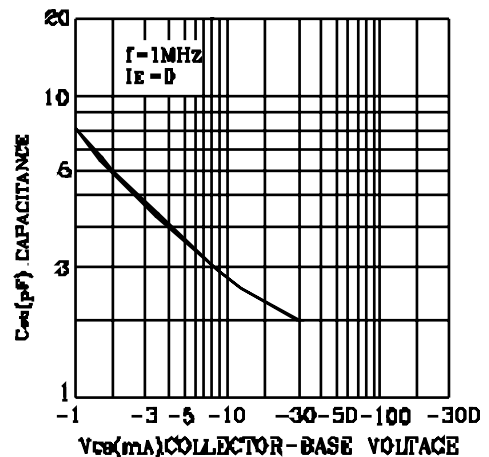

TO-92 Unit:mm

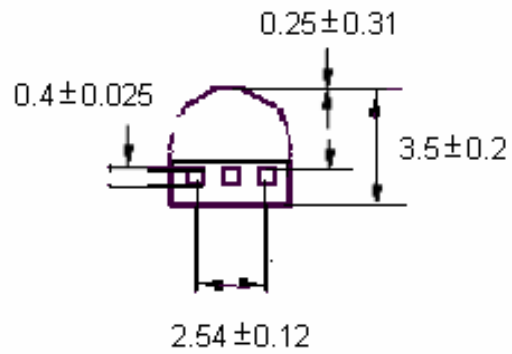
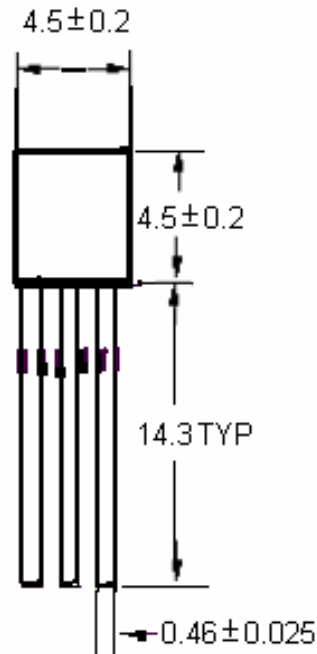

SOT-23 Unit:mm

