

TECHNICAL DATA
DATA SHEET 4134, REV. B PRELIMINARY

High Speed CMOS Optocoupler

Features:

- Hermetic / Ceramic packages
- Wide Operating Range (4.5V to 20V)
- 300ns propagation delay
- 5Mbd Typical Signal Rate
- Low Input Current (1.6mA to 1.8mA)
- CMOS Output

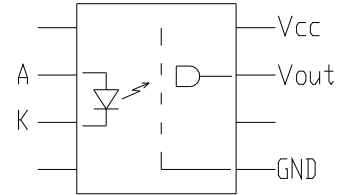

-111 (DIP)

Applications:

- High Speed Isolation
- Ground Loop Elimination
- Pulse Transformer Replacement
- High Speed Line Receiver
- Power Control Systems

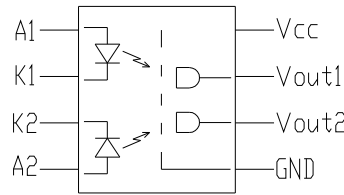

-121 (DIP)

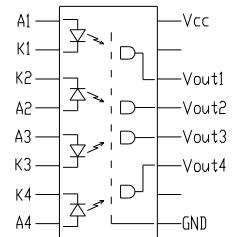

-141 (DIP)

Absolute Maximum Ratings

PARAMETER		SYMBOL	RATING	UNIT
Input	Forward Current	I_F	10	mA
	Peak Forward Current*	I_{FM}	25	mA
	Reverse Voltage	V_R	6	V
Output	Supply Voltage	V_{CEO}	0 to 20	V
	Output Voltage	V_{ECO}	-.5 to 20	V
	Current	I_C	25	mA
	Total Power Dissipation	P_C	200	mW
Isolation Voltage**		V_{iso}	5000	V_{rms}
Operating Temperature		T_{opr}	-55 to +125	°C
Storage Temperature		T_{stg}	-55 to +150	°C
Soldering Temperature***		T_{sol}	260	°C

* < 1 ms duration

** AC for 1 min, 40 to 60% RH

*** For 10 seconds

Electro-Optical Characteristics (-55° to 125°C)

PARAMETER	SYMBOL	CONDITIONS	MIN	TYP	MAX	UNIT
Forward Voltage	V_F	$I_F = 1 \text{ mA}$	-	1.1	1.4	V
Reverse Current	I_R	$V_R = 4 \text{ V}$	-	-	12	μA
Reverse Breakdown Voltage	BV_R	$I_R = 15 \mu\text{A}$	6	-	-	V
Terminal Capacitance	C_t	$V = 0, f = 1 \text{ kHz}$	-	35	240	pF
Logic Low Output Voltage	V_{OL}	$I_{OL} = 5 \text{ mA}$	-	-	0.5	V
Logic High Output Voltage	V_{OH}	$I_{OH} = -2.5 \text{ mA}$	2.4	-	-	V
Isolation Resistance	R_{ISO}	$500 V_{DC}, 40-60\% \text{ RH}$	4×10^{10}	10^{11}	-	Ω
Floating Capacitance	C_F	$f = 1 \text{ MHz}$	-	0.6	1.0	pF
Supply Current, low (per device)	I_{SL}	$I_F = 0 \text{ mA}, V_{CC} = 20 \text{ V}$	-	-	7	mA
Supply Current, high (per device)	I_{SH}	$I_F = 5 \text{ mA}, V_{CC} = 20 \text{ V}$	-	-	5	mA
Propagation Delay, low to high	t_{LH}	-	-	-	300	ns
Propagation Delay, high to low	t_{HL}	-	-	-	300	ns
Rise Time	t_r	-	-	30	-	ns
Fall Time	t_f	-	-	7	-	ns

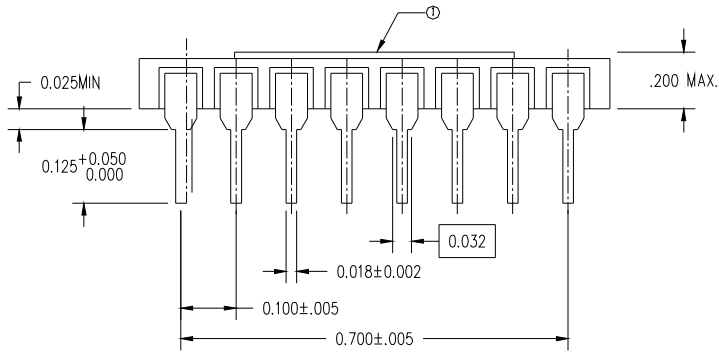
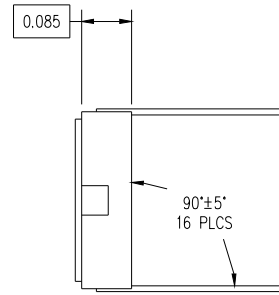
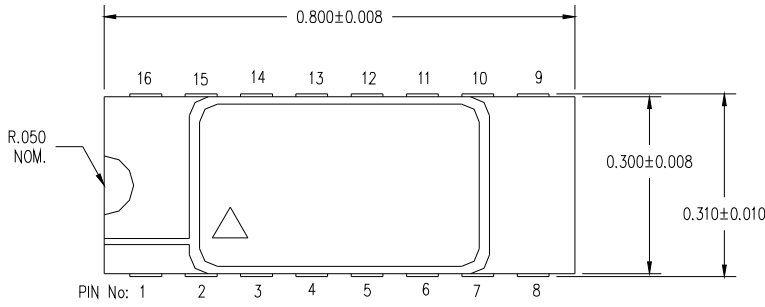

**CERAMIC
16 PIN DIP**

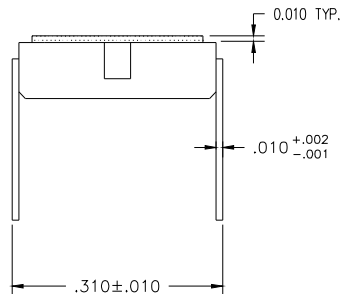
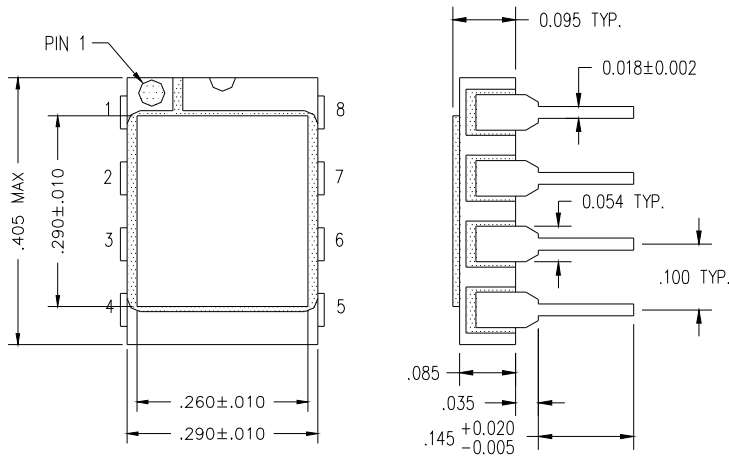

**CERAMIC
8 PIN DIP**

TECHNICAL DATA

DISCLAIMER:

- 1- The information given herein, including the specifications and dimensions, is subject to change without prior notice to improve product characteristics. Before ordering, purchasers are advised to contact the Sensitron Semiconductor sales department for the latest version of the datasheet(s).
- 2- In cases where extremely high reliability is required (such as use in nuclear power control, aerospace and aviation, traffic equipment, medical equipment, and safety equipment), safety should be ensured by using semiconductor devices that feature assured safety or by means of users' fail-safe precautions or other arrangement.
- 3- In no event shall Sensitron Semiconductor be liable for any damages that may result from an accident or any other cause during operation of the user's units according to the datasheet(s). Sensitron Semiconductor assumes no responsibility for any intellectual property claims or any other problems that may result from applications of information, products or circuits described in the datasheets.
- 4- In no event shall Sensitron Semiconductor be liable for any failure in a semiconductor device or any secondary damage resulting from use at a value exceeding the absolute maximum rating.
- 5- No license is granted by the datasheet(s) under any patents or other rights of any third party or Sensitron Semiconductor.
- 6- The datasheet(s) may not be reproduced or duplicated, in any form, in whole or part, without the expressed written permission of Sensitron Semiconductor.
- 7- The products (technologies) described in the datasheet(s) are not to be provided to any party whose purpose in their application will hinder maintenance of international peace and safety nor are they to be applied to that purpose by their direct purchasers or any third party. When exporting these products (technologies), the necessary procedures are to be taken in accordance with related laws and regulations.