

**Synthesizer, SMT for RFID
Covering all UHF Bands**

**MASY-007028
V1**

Features

- Fully Integrated VCO, PLL, Loop Filter
- Includes TCXO with <10 PPM Stability
- Low Phase Noise
- High Performance, Low Cost
- Covers US, European and Japanese RFID Bands
- Lead-Free Land Grid Array Package
- Tape and Reel Packaging Available
- 260°C Reflow Compatible

Functional Block Diagram

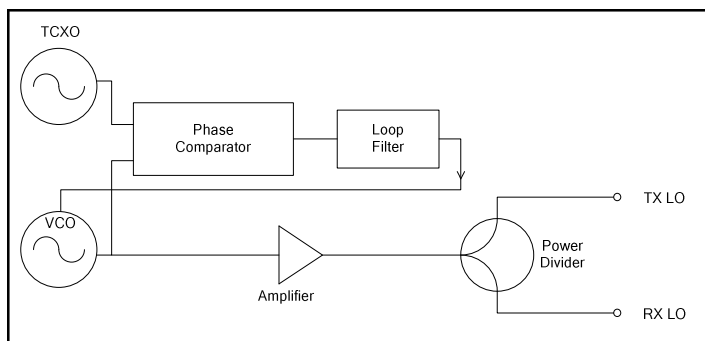

Description

This synthesizer design integrates a high performance VCO, PLL IC, and discrete loop filter into a surface mount package. A high stability frequency reference is also included. This SMT package provides electrical shielding, easy PCB assembly, and repeatable performance.

Applications

These synthesizers are well suited for applications where small size and high performance is required. This synthesizer is specifically targeted for the RFID market in the United States, European, and Japanese bands. This synthesizer can also be used for other applications in these frequency ranges.

Ordering Information^{1, 4, 5}

| Model No. | Band | Frequency | Package |
|--------------------|----------|---------------|---------------------------|
| MASY-007028-0001TR | US | 902 - 928 MHz | Tape and Reel |
| MASY-007028-000100 | US | 902 - 928 MHz | Bulk |
| MASY-007028-0001TB | US | 902 - 928 MHz | Sample Board ² |
| MASY-007028-SW01TB | US | 902 - 928 MHz | Sample Board ³ |
| MASY-007028-0001TR | European | 865 - 868 MHz | Tape and Reel |
| MASY-007028-000100 | European | 865 - 868 MHz | Bulk |
| MASY-007028-0001TB | European | 865 - 868 MHz | Sample Board ² |
| MASY-007028-SW01TB | European | 865 - 868 MHz | Sample Board ³ |
| MASY-007028-0002TR | Japanese | 950 - 956 MHz | Tape and Reel |
| MASY-007028-000200 | Japanese | 950 - 956 MHz | Bulk |
| MASY-007028-0002TB | Japanese | 950 - 956 MHz | Sample Board ² |
| MASY-007028-SW02TB | Japanese | 950 - 956 MHz | Sample Board ³ |

1. The US and European bands share the same part. The listings are separated to illustrate the different frequencies.
2. This is the synthesizer installed on a sample board. This does not include the evaluation software or the test cable.
3. This is the synthesizer installed on a sample board. It also includes software (including a brief manual on how to use the software), and a cable to interface with a Windows™ based PC having a parallel port.
4. Reference Application Note M513 for reel size information.
5. Die quantity varies.

¹ * Restrictions on Hazardous Substances, European Union Directive 2002/95/EC.

M/A-COM Inc. and its affiliates reserve the right to make changes to the product(s) or information contained herein without notice. M/A-COM makes no warranty, representation or guarantee regarding the suitability of its products for any particular purpose, nor does M/A-COM assume any liability whatsoever arising out of the use or application of any product(s) or information.

- **North America** Tel: 800.366.2266 / Fax: 978.366.2266
- **Europe** Tel: 44.1908.574.200 / Fax: 44.1908.574.300
- **Asia/Pacific** Tel: 81.44.844.8296 / Fax: 81.44.844.8298

Visit www.macom.com for additional data sheets and product information.

**Synthesizer, SMT for RFID
Covering all UHF Bands**

**MASY-007028
V1**

Electrical Specifications – US & European Bands⁶

T_A = +25°C, Z_o = 50 Ω, V_{DD1} = 3.3V, V_{DD2} = 3.3V

| Parameter | Test Conditions | Units | Min | Typ | Max |
|-------------------------------------|---|--|--------------------------------------|---|--------------------------------------|
| Frequency Range | US Band European Band | MHz MHz | 902 865 | - - | 928 868 |
| Frequency Stability | Over T _{op} ⁷ | ppm | - | - | 10 |
| RF Output Power | At 25°C Over T _{op} ⁷ | dBm dBm | +4.0 +3.0 | - | +6.2 +7.5 |
| Phase Noise | SSB at 100 Hz offset from carrier SSB at 1 KHz offset from carrier SSB at 10 KHz offset from carrier SSB at 100 KHz offset from carrier SSB at 200 KHz offset from carrier SSB at 1 MHz offset from carrier SSB at 2 MHz offset from carrier SSB at 3 MHz offset from carrier | dBc/Hz dBc/Hz dBc/Hz dBc/Hz dBc/Hz dBc/Hz dBc/Hz dBc/Hz | - - - - - - - - | -72 -75 -80 -112 -121 -135 -140 -142 | - - - - - - - - |
| Phase Jitter | From 10 kHz to 100 kHz using brick wall filter | deg rms | - | 0.34 | - |
| Harmonic Suppression | 2nd 3rd and higher 1.25 * Fo 1.5 * Fo Sub-harmonics | dBc dBc dBc dBc dBc | - - - - - | -35 -35 -80 -85 -80 | -20 -25 -60 -60 -60 |
| Spurious Suppression (Non-Harmonic) | Phase comparison frequency (± 50 KHz) | dBc | - | -65 | - |
| Spurious Suppression (Non-Harmonic) | Reference breakthrough (± 16 MHz) | dBc | - | -80 | |
| Frequency Lock Time | Over Fout, PFD frequency = 50 KHz, Loop bandwidth = 5 KHz Measured to within ± 1 kHz Measured to within ± 10 Hz | us us | - - | 700 800 | - - |
| VDD1 ⁸ | Recommended Operating Condition | V | +3.00 | +3.30 | +3.45 |
| IDDD1 ¹¹ | Recommended Operating Condition | mA | - | 45 | 60 |
| VDD2 ⁹ | Recommended Operating Condition | V | +3.00 | +3.30 | +3.45 |
| IDDD2 | Recommended Operating Condition | mA | - | 25 | 35 |
| RF Impedance | At RX_LO and TX_LO ¹⁰ | Ω | - | 50 | - |
| Isolation | Between RX_LO and TX_LO | dB | - | 20 | - |
| Step Size | Over T _{op} ⁷ | KHz | - | 50 | - |
| Output Frequencies | For US RFID readers, there are 50 equally spaced frequencies. The minimum and maximum frequencies are to the right. There are 49 steps with a step size of 500 KHz. For European RFID readers, there are 15 equally spaced frequencies. The minimum and maximum frequencies are to the right. There are 14 steps with a step size of 200 KHz | MHz MHz | 902.750 865.100 | - - | 927.250 867.900 |
| PLL Programming | 3-wire serial CMOS in accordance with Analog Devices ADF4360-7. | | | | |

**Synthesizer, SMT for RFID
Covering all UHF Bands**

**MASY-007028
V1**

Electrical Specifications – Japanese Band⁶:

T_A = +25°C, Z_o = 50 Ω, V_{DD1} = 3.3V, V_{DD2} = 3.3V

| Parameter | Test Conditions | Units | Min | Typ | Max |
|-------------------------------------|--|--|--------------------------------------|---|--------------------------------------|
| Frequency Range | Japanese Band | MHz | 952 | - | 954 |
| Frequency Stability | Over T _{op} ⁷ | ppm | - | - | 10 |
| RF Output Power | At 25°C Over T _{op} ⁷ | dBm dBm | +4.0 +3.0 | - | +6.2 +7.5 |
| Phase Noise | SSB at 100 Hz offset from carrier SSB at 1 KHz offset from carrier SSB at 10 KHz offset from carrier SSB at 100 KHz offset from carrier SSB at 200 KHz offset from carrier SSB at 1 MHz offset from carrier SSB at 2 MHz offset from carrier SSB at 3 MHz offset from carrier | dBc/Hz dBc/Hz dBc/Hz dBc/Hz dBc/Hz dBc/Hz dBc/Hz dBc/Hz | - - - - - - - - | -74 -76 -81 -113 -120 -134 -136 -142 | - - - - - - - - |
| Phase Jitter | From 10 kHz to 100 kHz using brick wall filter | deg rms | - | 0.34 | - |
| Harmonic Suppression | 2nd 3rd and higher 1.25 * Fo 1.5 * Fo Sub-harmonics | dBc dBc dBc dBc dBc | - - - - - | -35 -35 -80 -85 -80 | -20 -25 -60 -60 -60 |
| Spurious Suppression (Non-Harmonic) | Phase comparison frequency (± 200 KHz) | dBc | - | -75 | - |
| Spurious Suppression (Non-Harmonic) | Reference breakthrough (± 16 MHz) | dBc | - | -80 | - |
| Frequency Lock Time | Over F _{out} , PFD frequency = 200 KHz, Loop bandwidth = 5 KHz Measured to within ± 1 kHz Measured to within ± 10 Hz | us us | - - | 700 800 | - - |
| VDD1 ⁸ | Recommended Operating Condition | V | +3.00 | +3.30 | +3.45 |
| IDD1 ¹¹ | Recommended Operating Condition | mA | - | 45 | 60 |
| VDD2 ⁹ | Recommended Operating Condition | V | +3.00 | +3.30 | +3.45 |
| IDD2 | Recommended Operating Condition | mA | - | 20 | 35 |
| RF Impedance | At RX_LO and TX_LO ¹⁰ | Ω | - | 50 | - |
| Isolation | Between RX_LO and TX_LO | dB | - | 20 | - |
| Step Size | Over T _{op} ⁷ | KHz | - | 200 | - |
| Output Frequencies | For Japanese RFID readers, there are 9 equally spaced frequencies. The minimum and maximum frequencies are to the right. There are 8 steps with a step size of 200 KHz. | MHz | 952.200 | - | 953.800 |
| PLL Programming | 3-wire serial CMOS in accordance with Analog Devices ADF4360-7. | | | | |

6. All specification limits are indicated values @ 25°C and apply over F_{out} unless otherwise indicated.

7. T_{op} = -30°C to +70°C operating temperature.

8. VDD1 is the bias for the TCXO, VCO, and the synthesizer.

9. VDD2 is the bias for the amplifier.

10. Opposite port is terminated in 50 ohms.

11. IDD1 includes approximately 10 mA which drives an optional external Lock Detector LED.

**Synthesizer, SMT for RFID
Covering all UHF Bands**

**MASY-007028
V1**

Pin Configuration

| Pin No. | Function | Pin No. | Function |
|---------|--------------------|---------|--------------------|
| 1 | GND | 21 | GND |
| 2 | GND | 22 | GND |
| 3 | GND | 23 | GND |
| 4 | GND | 24 | GND |
| 5 | RX_LO | 25 | CLK |
| 6 | GND | 26 | DATA |
| 7 | GND | 27 | LE |
| 8 | TX_LO | 28 | VDD1 ¹² |
| 9 | GND | 29 | MUXOUT |
| 10 | GND | 30 | CE |
| 11 | VDD1 ¹² | 31 | GND |
| 12 | GND | 32 | VDD1 ¹² |
| 13 | GND | 33 | GND |
| 14 | GND | 34 | GND |
| 15 | GND | 35 | VDD2 |
| 16 | GND | 36 | GND |
| 17 | GND | 37 | GND |
| 18 | GND | 38 | GND |
| 19 | GND | 39 | GND |
| 20 | GND | 40 | GND |

12. Pins 11, 28, and 32 are not tied together on the synthesizer. They all must be tied together on the PC Board

Absolute Maximum Ratings ^{13,14}

| Parameter | Absolute Maximum |
|-----------------------|----------------------|
| VDD1 to GND | -0.3V to +3.9V |
| VDD2 to GND | -0.3V to +6.0V |
| CLK, DATA, LE, MUXOUT | -0.3V to VDD1 + 0.3V |
| Operating Temperature | -30°C to +70°C |
| Storage Temperature | -40°C to +125°C |

- 13. Exceeding any one or combination of these limits may cause permanent damage to this device.
- 14. M/A-COM does not recommend sustained operation near these survivability limits.

Handling Procedures

Please observe the following precautions to avoid damage:

Static Sensitivity

Silicon and Gallium Arsenide Integrated Circuits are sensitive to electrostatic discharge (ESD) and can be damaged by static electricity. Proper ESD control techniques should be used when handling these devices.

**Synthesizer, SMT for RFID
Covering all UHF Bands**

**MASY-007028
V1**

Recommended PCB Configuration^{15,16,17}

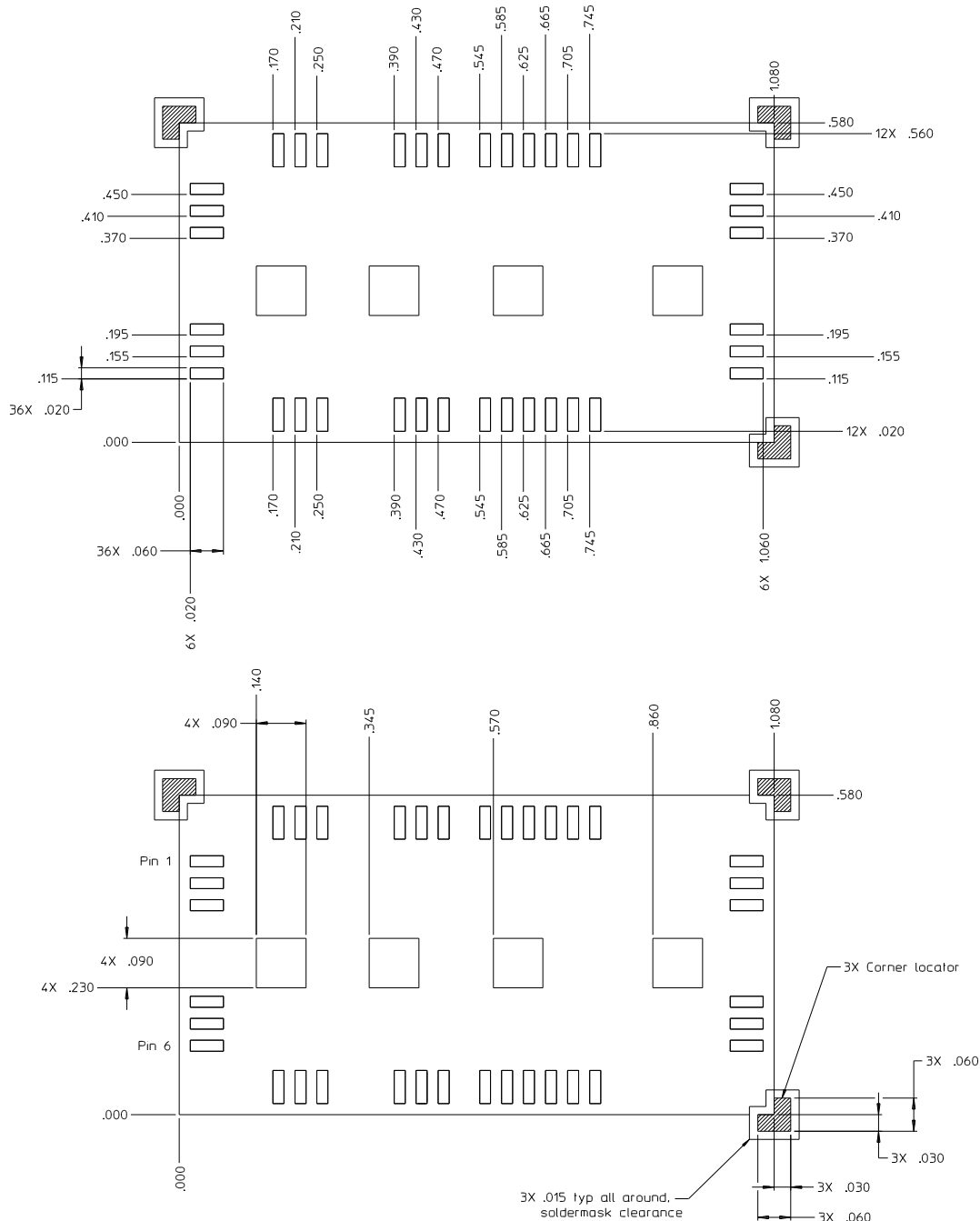

15. Corner locators are needed for manual placement and are strongly recommended.
16. Soldermask should be line to line with the pads on the bottom of the part.
17. Soldermask should be cleared 15 mils outside the corner locators. This ensures that they are easily visible.

**Synthesizer, SMT for RFID
Covering all UHF Bands**

**MASY-007028
V1**

Typical Performance Curves

**Output Power vs. Temperature: VDD1 & VDD2 = 3.3V
MASY-007028-000100, US Band**

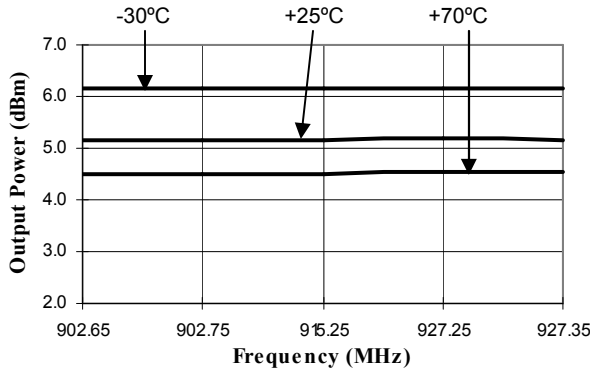

**Output Power vs. Temperature: VDD1 & VDD2 = 3.3V
MASY-007028-000100, European Band**

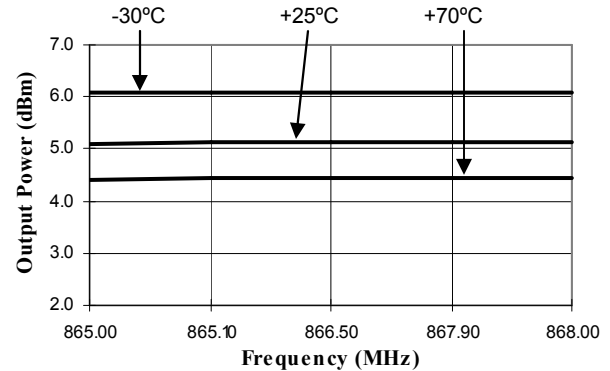

**Output Power vs. Temperature: VDD1 & VDD2 = 3.0V
MASY-007028-000100, US Band**

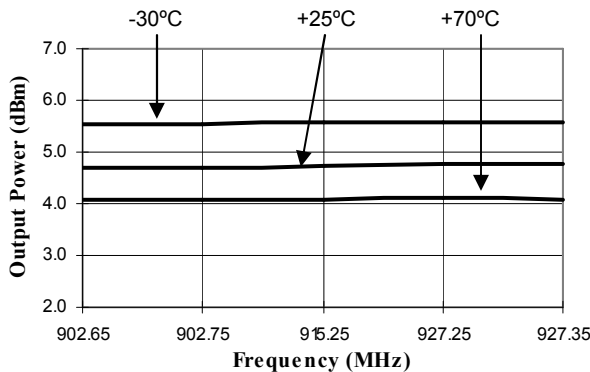

**Output Power vs. Temperature: VDD1 & VDD2 = 3.0V
MASY-007028-000100, European Band**

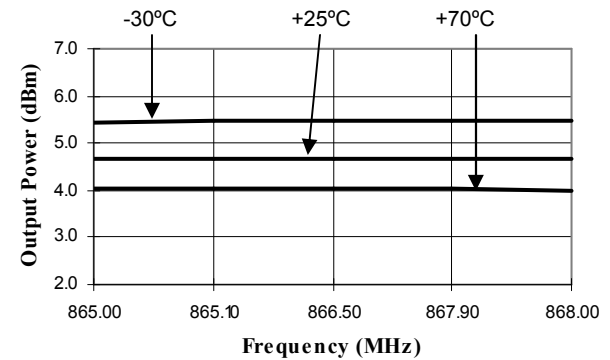

**Output Power vs. Temperature: VDD1 & VDD2 = 3.45V
MASY-007028-000100, US Band**

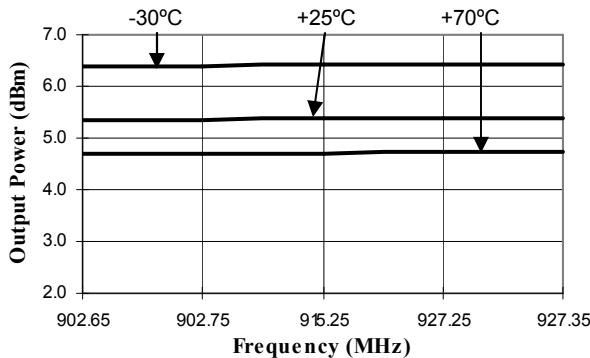

**Output Power vs. Temperature: VDD1 & VDD2 = 3.45V
MASY-007028-000100, European Band**

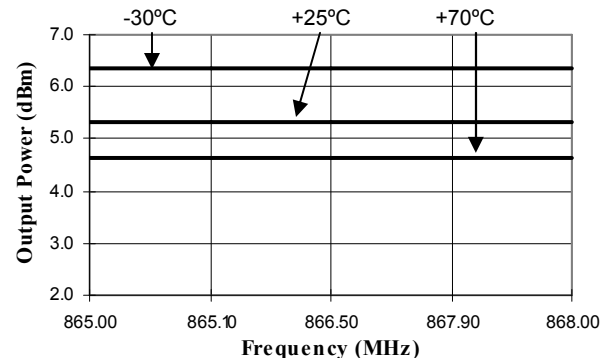

**Synthesizer, SMT for RFID
Covering all UHF Bands**

**MASY-007028
V1**

Typical Performance Curves

SSB Phase Noise
MASY-007028-000100, US & European Band

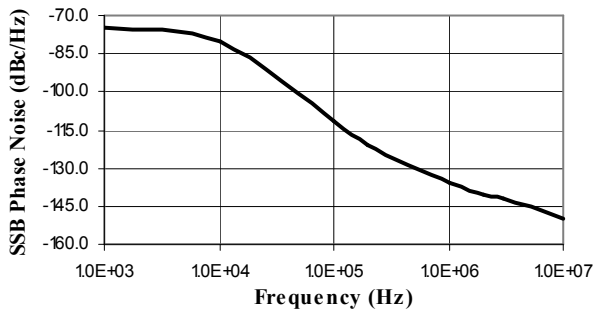

Harmonics vs. Frequency: VDD1 & VDD2 = 3.3V, 25°C
MASY-007028-000100, US Band

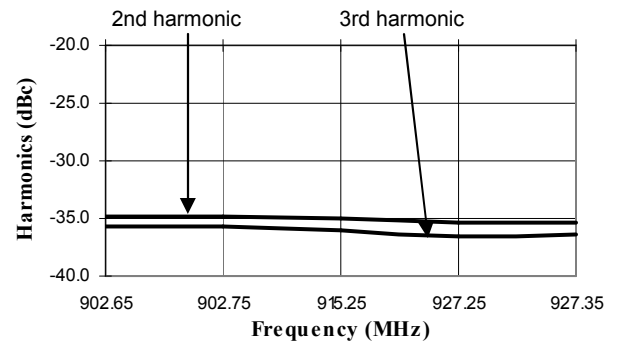

Harmonics vs. Frequency: VDD1 & VDD2 = 3.3V, 25°C
MASY-007028-000100, European Band

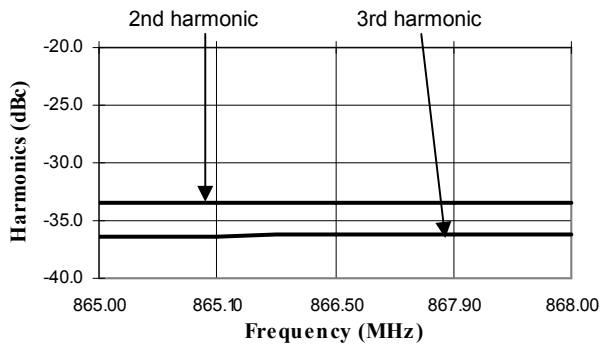

Output Power vs. Temperature: VDD1 & VDD2 = 3.3V
MASY-007028-000200, Japanese Band

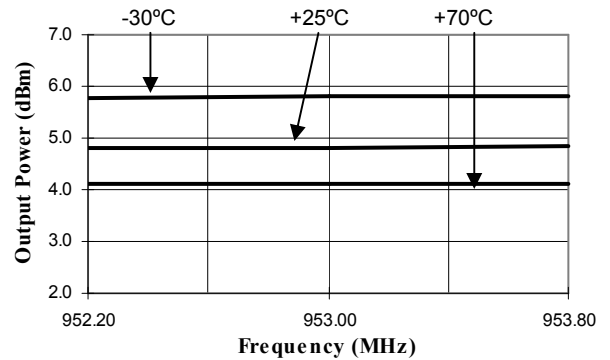

Typical Performance Curves

**Output Power vs. Temperature: VDD1 & VDD2 = 3.0V
MASY-007028-000200, Japanese Band**

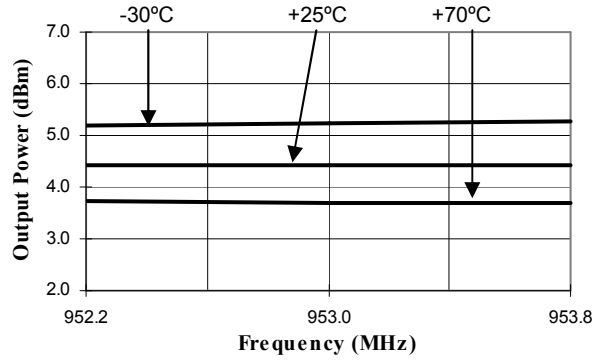

**Output Power vs. Temperature: VDD1 & VDD2 = 3.45V
MASY-007028-000200, Japanese Band**

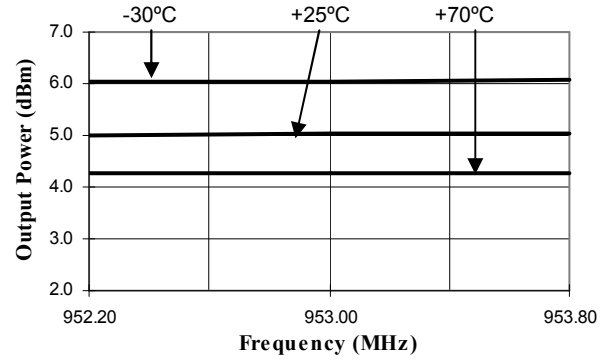

**SSB Phase Noise
MASY-007028-000200, Japanese Band**

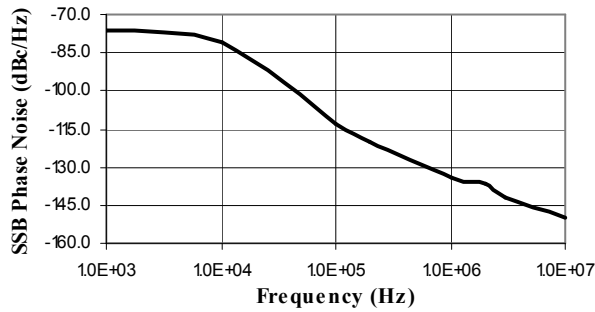

**Harmonics vs. Frequency: VDD1 & VDD2 = 3.3V, 25°C
MASY-007028-000200, Japanese Band**

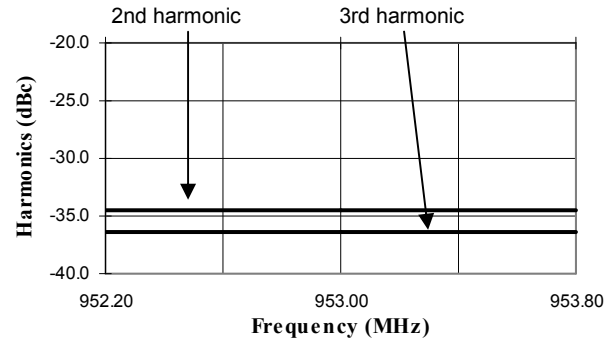

Sample Board Pin Configuration

Pin Configuration J1

| Pin No. | Function | Pin No. | Function |
|---------|---------------|---------|-----------|
| 1 | GND | 6 | VDD1 |
| 2 | GND | 7 | LE |
| 3 | CE | 8 | VDD2 |
| 4 | MUXOUT | 9 | J2-6 (D4) |
| 5 | SCOPE-TRIGGER | 10 | GND |

Pin Configuration J2¹⁸

| Pin No. | Function |
|---------|------------------------|
| 1 | NC |
| 2 | DATA |
| 3 | CLK |
| 4 | GND |
| 5 | TP1 (D5) ¹⁹ |
| 6 | D4 ¹⁹ |
| 7 | LE |
| 8 | SCOPE-TRIGGER |
| 9 | GND |

18. J2 is Tyco Electronics P/N 5747840-5
19. D4 and D5 are uncommitted PC Parallel Port data bits

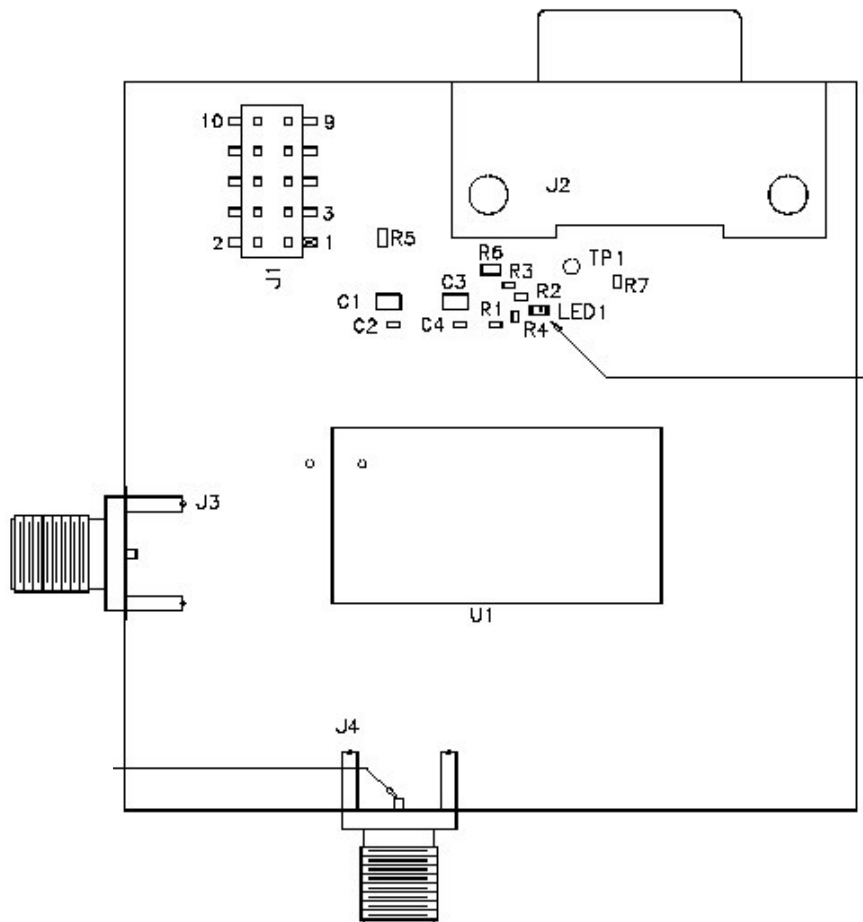

**Synthesizer, SMT for RFID
Covering all UHF Bands**

**MASY-007028
V1**

Sample Board Schematic and Bill of Material

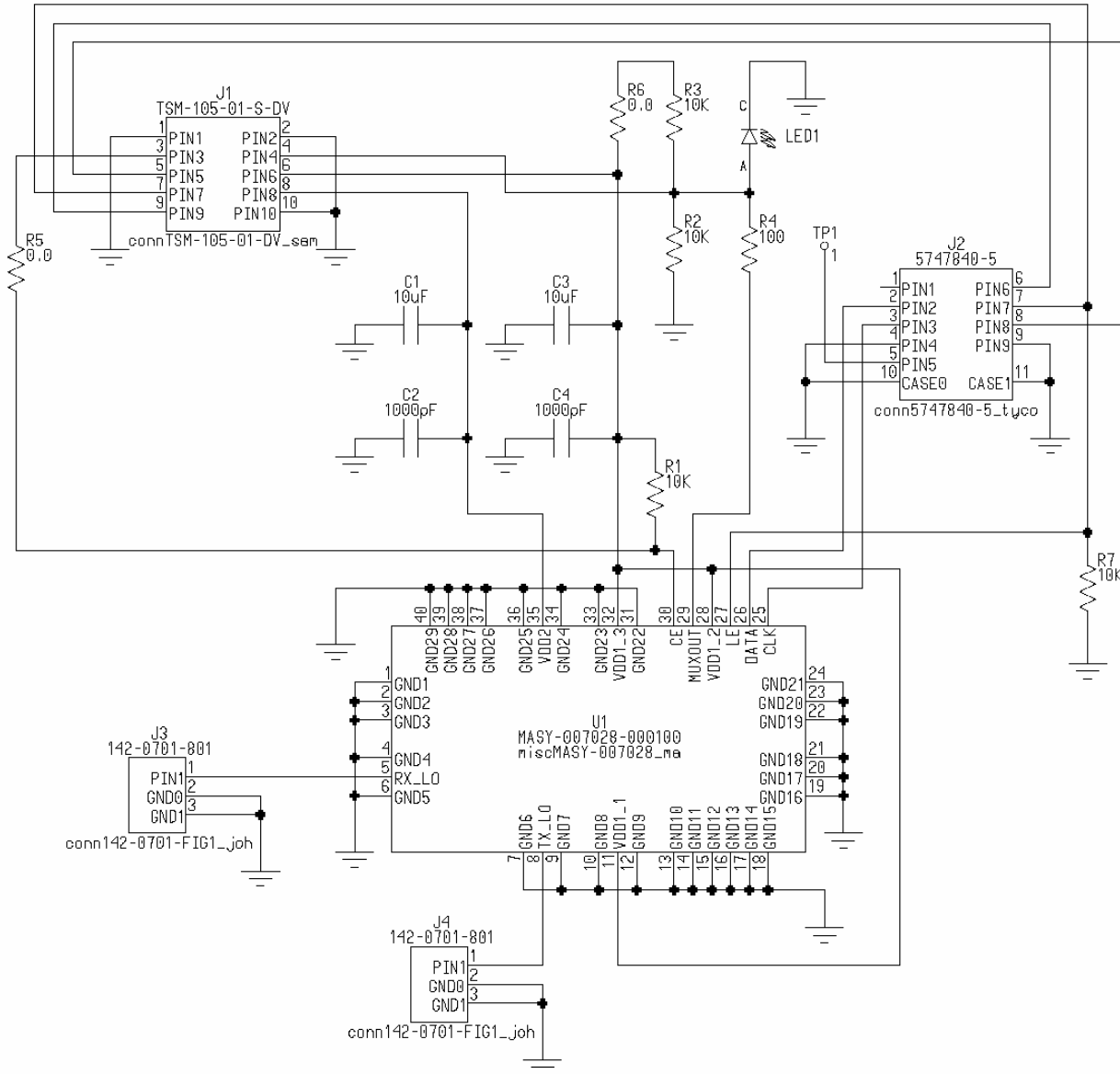

| Qty | Part Number | Description | Reference Designator |
|-----|--------------------|--|----------------------|
| 1 | | Resistor,100 ohm,1%,1/16W,0402 | R4 |
| 3 | | Resistor,10K,1%,1/16W,0402 | R1,R2,R3,R7 |
| 2 | | Capacitor,1000pF,10%,50V,0402,COG | C2,C4 |
| 2 | | Capacitor,10 uF,10%,6.3V,0805,X5R | C1,C3 |
| 1 | 1000026283-0000001 | LED,0603,Green (Ledtronics) | LED1 |
| 2 | 142-0701-801 | Connector, SMA, End Launch Jack | J3,J4 |
| 1 | 5747840-5 | Connector,9P,90 Deg,Plug,Through (Tycoelectronics) | J2 |
| 1 | MASY-007028-000100 | RFID Synthesizer (M/A-COM) | U1 |
| 2 | RK73Z-1JT | Resistor,0 ohm,1.0A MAX,0603 | R5,R6 |
| 1 | TSM-105-01-S-DV | Connector, Termstrip, 10P_2R, .230 Post Height | J1 |

Test Cable that is provided with MASY-007028-SWxxTB^{20,21}

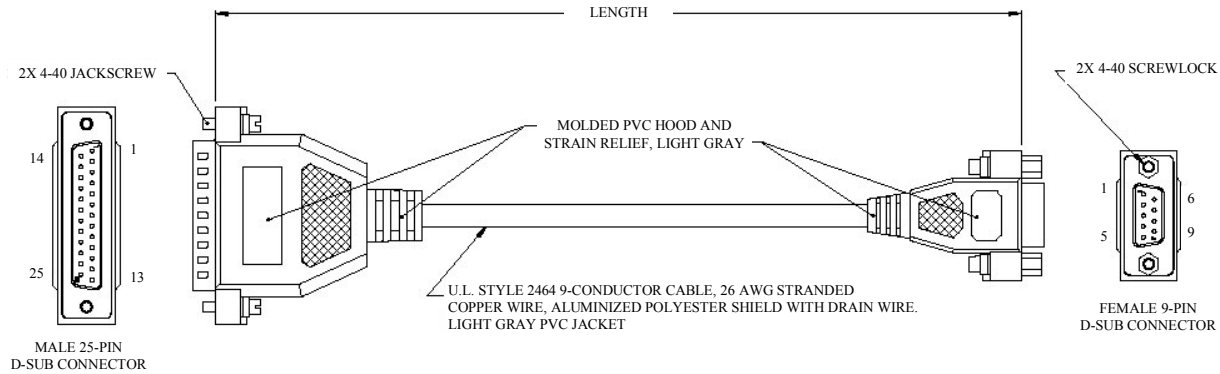

- 20. Length is 72 inches
- 21. Connector pins are gold.

Wiring Chart

| DB25M | DB9F |
|--------|-------|
| PIN 8 | PIN 1 |
| PIN 3 | PIN 2 |
| PIN 2 | PIN 3 |
| PIN 20 | PIN 4 |
| PIN 7 | PIN 5 |
| PIN 6 | PIN 6 |
| PIN 4 | PIN 7 |
| PIN 5 | PIN 8 |
| PIN 22 | PIN 9 |
| SHELL | SHELL |

Land Grid Array Outline Drawing†

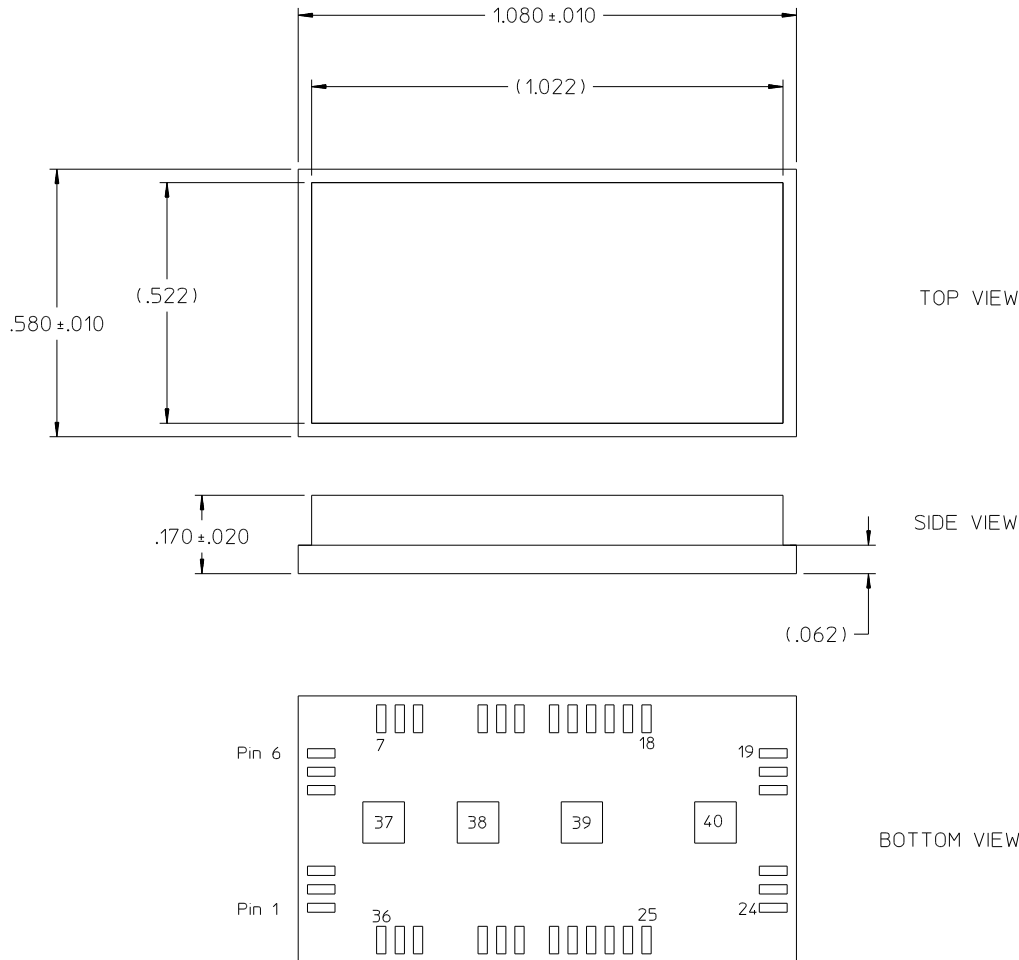

The PC Board Configuration contains detailed pad sizes and locations.

† Reference Application Note M538 for lead-free solder reflow recommendations.