

363-431

Fast Turn-Off Asymmetric Thyristor

Issue 2.0 November 1993

Applications

- High frequency applications
- Regulated power supplies
- Capacitor discharge
- Ultrasonic generators
- Induction heating
- Electronic welding

Features

- The ACR 25U is a glass passivated asymmetric thyristor which has exceptionally fast turn-off capabilities combined with good turn-on characteristics.

Key Parameters

V_{DRM}	800V
$I_{T(AV)}$	25A
I_{TSM}	300A
di/dt	2000A/ μ s
dV/dt	500V/ μ s
t_q	4.0 μ s

Package Outline

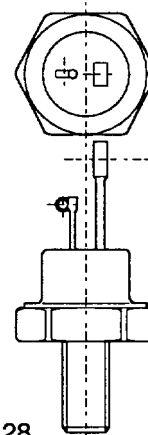

Outline type No: SO 28.

For further outline information turn to page 7.

Voltage Ratings

Type Number	Repetitive Peak Off-state Voltage V_{DRM}	Repetitive Peak Reverse Voltage V_{RRM}
ACR 25U 08LG	800	10
ACR 25U 06LG	600	10
ACR 25U 04LG	400	10

Current Ratings

Symbol	Parameter	Conditions	Max.	Units
$I_{T(AV)}$	Mean on-state current	Halfwave, resistive load, $T_{case} = 70^{\circ}C$	25	A
$I_{T(RMS)}$	RMS value	$T_{case} = 90^{\circ}C$	25	A
I_T	Continuous (direct) on-state current	$T_{case} = 70^{\circ}C$	40	A

ACR 25U

Fast Turn-Off Asymmetric Thyristor



Surge Ratings					
Symbol	Parameter	Conditions	Max.	Units	
I_{TSM}	Surge (non-repetitive) on-state current	$T_J = 125^\circ\text{C}$	300	A	
I^2t	I^2t for fusing	10ms half sine	450	A^2s	
di/dt	Rate of rise of on-state current	From V_{DRM} to 125A, Gate source 15V, 15Ω Rise time 50ns	2000	$\text{A}/\mu\text{s}$	
dV/dt	Min. linear rate of rise of off-state voltage	Gate open circuit $T_{case} = 125^\circ\text{C}$. To V_{DRM}	500†	$\text{V}/\mu\text{s}$	

† Available to 1000V/ μs

Thermal Ratings and Mechanical Data					
Symbol	Parameter	Conditions	Min.	Max.	Units
$R_{th(j-c)}$	Thermal resistance - junction to case	d.c.	-	0.75	$^\circ\text{C}/\text{W}$
$R_{th(c-h)}$	Thermal resistance - case to heatsink	Mounting torque 3.5Nm with mounting compound	-	0.3	$^\circ\text{C}/\text{W}$
T_{vj}	Virtual junction temperature	On-state (conducting)	-	125	$^\circ\text{C}$
T_{sto}	Storage temperature range		-55	125	$^\circ\text{C}$
-	Mounting torque		3.5	4.0	Nm

Characteristics					
$T_{case} = 25^\circ\text{C}$ unless stated otherwise					
Symbol	Parameter	Conditions	Typ.	Max.	Units
V_{TM}	On-state voltage	$I_T = 100\text{ A}$	-	2.2	V
I_{RM}/I_{DRM}	Peak reverse and off-state current	At V_{RRM}/V_{DRM} , $T_{case} = 125^\circ\text{C}$	-	10/10	mA
I_L	Latching current		90	-	mA
I_H	Holding current		45	-	mA
t_d	Delay time	$V_D = 300\text{V}$, Gate source = 15V, 15Ω	-	250	ns
t_q	Circuit commutated turn-off time	$I_T = 50\text{A}$, sq. wave 50 μs pulse, $T_{case} = 120^\circ\text{C}$, $di_R/dt = 50\text{A}/\mu\text{s}$ $dV/dt = 600\text{V}/\mu\text{s}$ to V_{DRM} Gate voltage at turn-off $< -1\text{V}$	-	4.0	μs
$V_{T(TO)}$	Threshold voltage	At T_{vj}	-	1.0	V
r_T	On-state slope resistance	At T_{vj}	-	12	$\text{m}\Omega$

Gate Trigger Characteristics and Ratings

$T_{case} = 25^{\circ}C$ unless otherwise stated

Symbol	Parameter	Conditions	Typ.	Max.	Units	
V_{GT}	Gate trigger voltage	$V_{DWM} = 12V, R_L = 30\Omega$	0.9	3	V	
I_{GT}	Gate trigger current	$V_{DWM} = 12V, R_L = 30\Omega$	60	200	mA	
V_{FGM}	Peak forward gate voltage		-	40	V	
V_{RGN}	Peak reverse gate voltage		-	10	V	
I_{FGM}	Peak forward gate current		-	10	A	
P_{GM}	Peak gate power		-	40	W	
$P_{G(AV)}$	Mean gate power	Averaging time = 10ms max.	Forward	-	10	W
			Reverse	-	6	W

Waveform Of Gate Voltage At Turn-Off

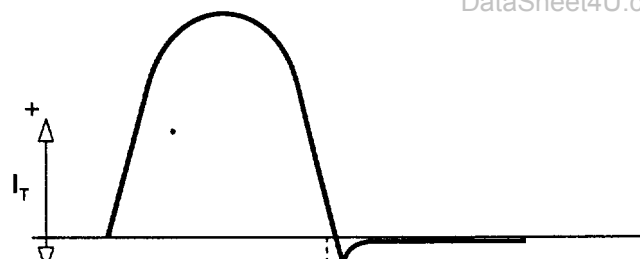

a) Anode current waveform

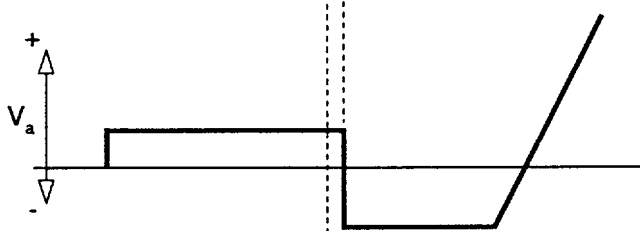

b) Anode voltage waveform

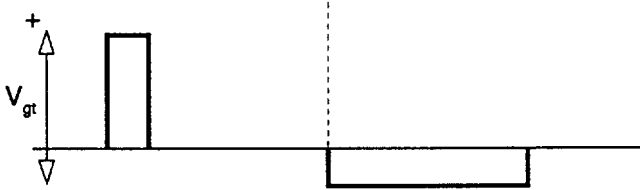

c) Gate voltage waveform

This device can be produced with exceptionally fast-turn on performance for use in circuits which require the switching of very short ($<1\mu s$) high current pulses. Please contact us for further information.

ACR 25U

Fast Turn-Off Asymmetric Thyristor



Curves

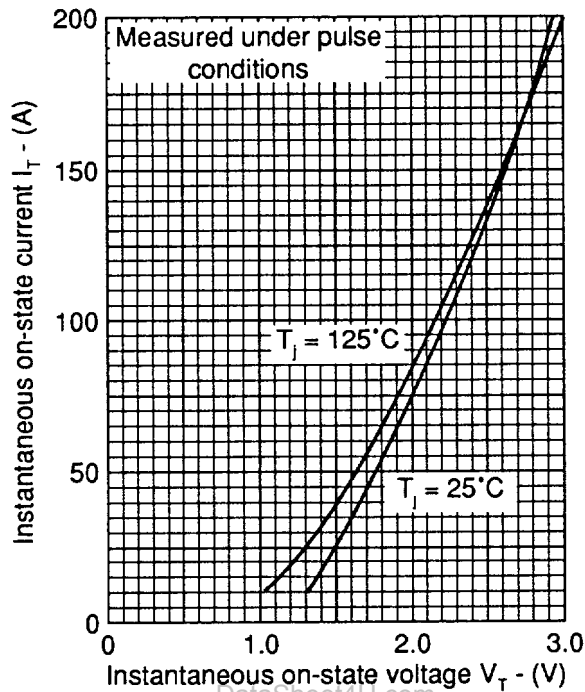

FIG. 1 MAXIMUM (LIMIT) ON-STATE CHARACTERISTICS

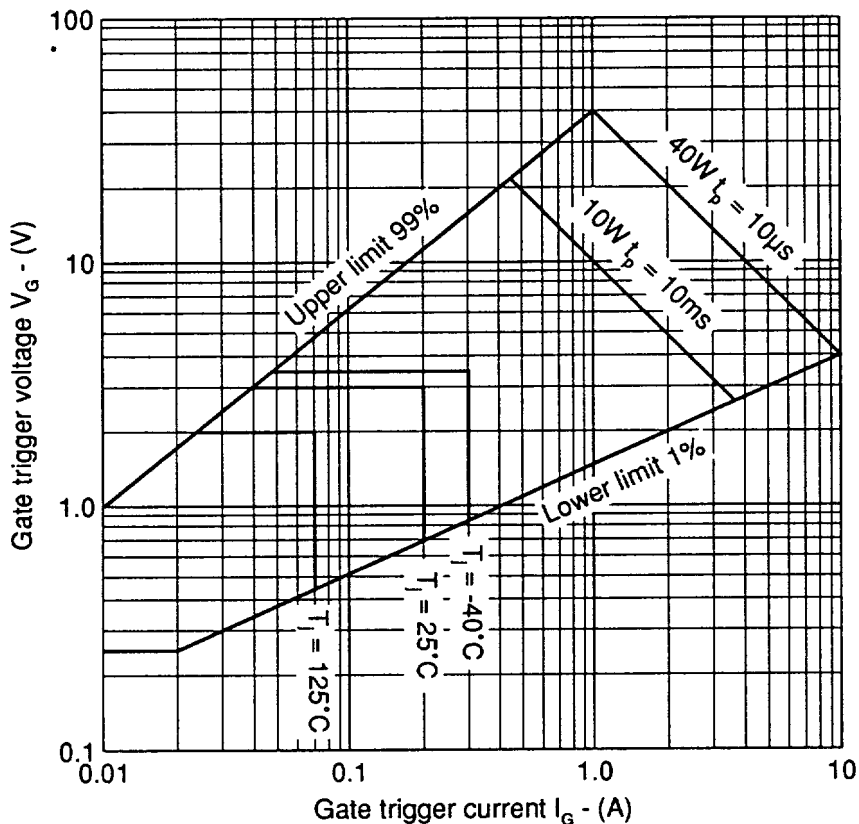

FIG. 2 GATE CHARACTERISTICS

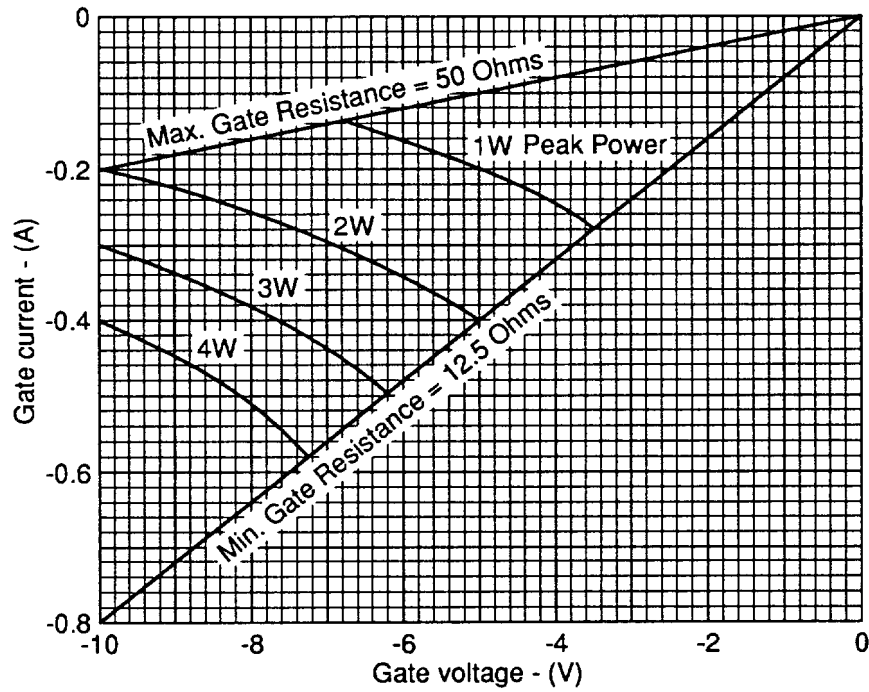

FIG. 3 REVERSE GATE CHARACTERISTICS

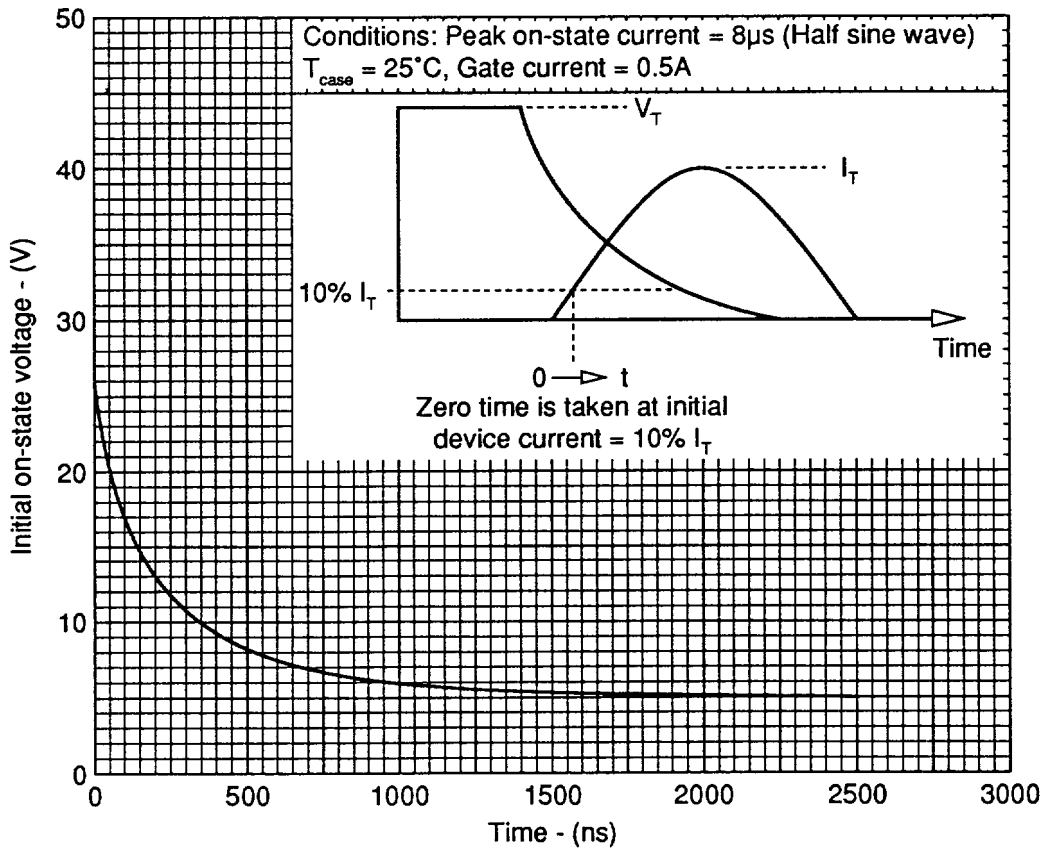

FIG. 4 TYPICAL INITIAL ON-STATE VOLTAGE vs TIME

ACR 25U

Fast Turn-Off Asymmetric Thyristor

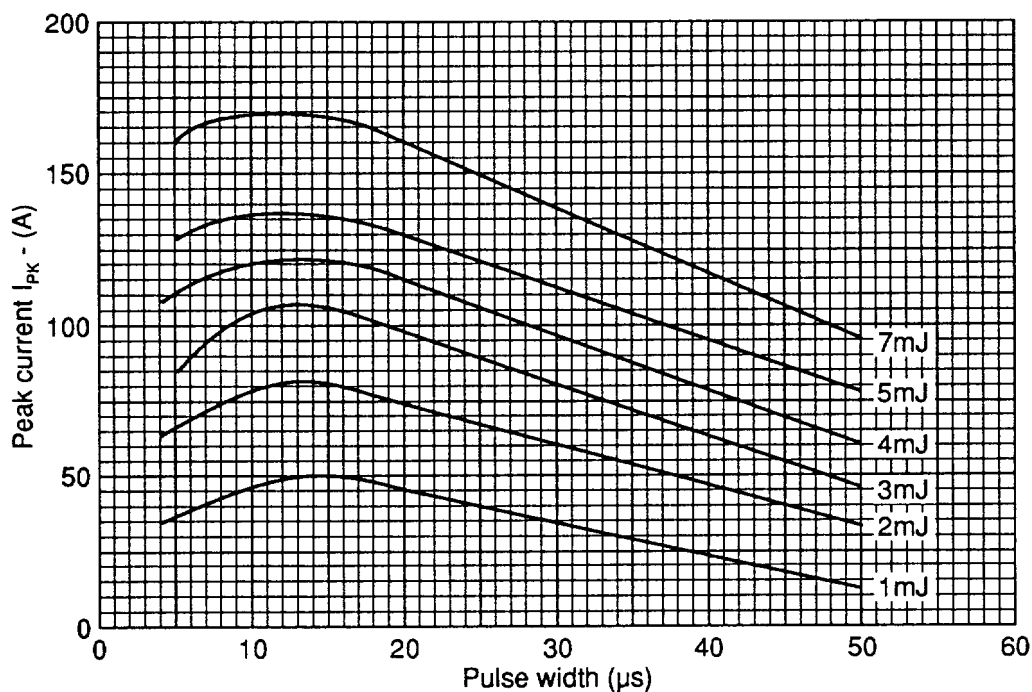

FIG. 5 MAXIMUM ENERGY LOSS PER PULSE WHEN SWITCHING A HALF SINUSOIDAL PULSE FROM 600V.

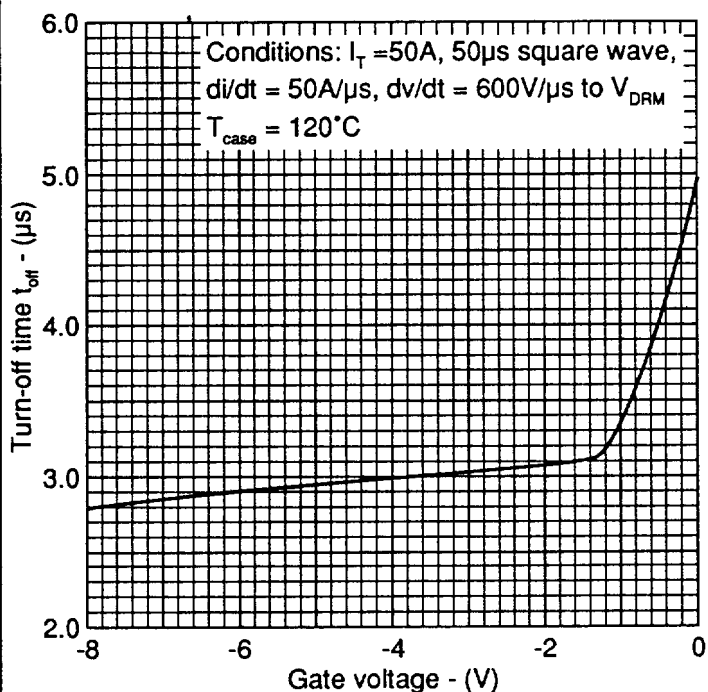

FIG. 6 TYPICAL CIRCUIT COMMUTATED TURN-OFF TIME vs GATE VOLTAGE AT TURN-OFF

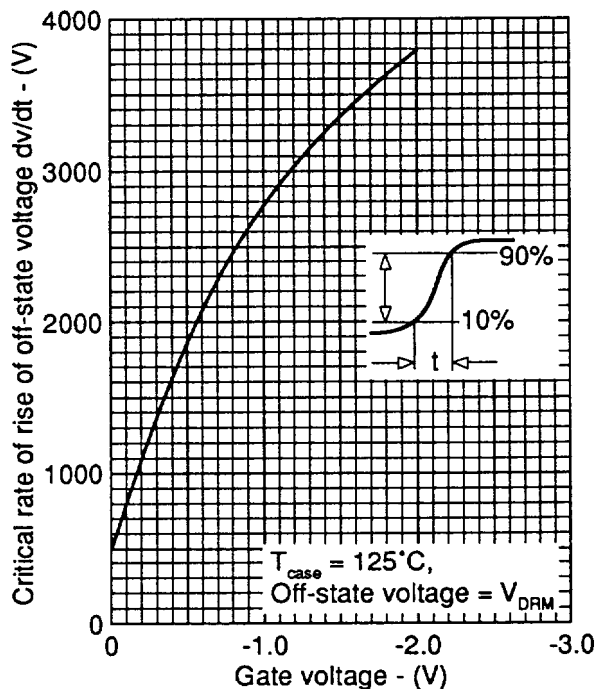
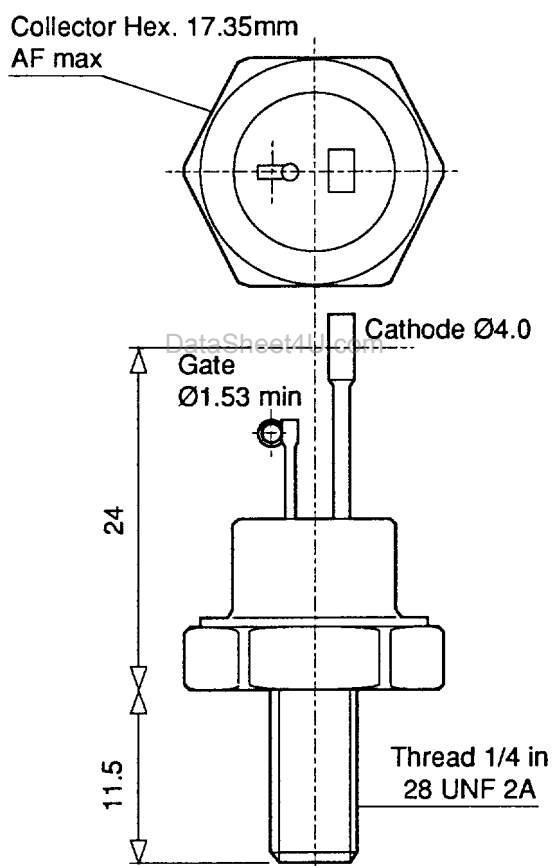

FIG. 7 MINIMUM LINEAR CRITICAL RATE OF RISE OF OFF-STATE VOLTAGE vs GATE VOLTAGE

Outline * SO 28

For full engineering drawing please consult factory.
DO NOT SCALE.
Conforms to SO 28.
All dimensions in mm
(Unless stated otherwise)



Weight: 10.5g

ACR 25U**Fast Turn-Off Asymmetric Thyristor**

et4U.com

DataSheet4U.com

POWER PRODUCT MAIN OFFICES

Carholme Road,
Lincoln. LN1 1SG.
UNITED KINGDOM.
Tel: + 44 (0)522 510500
Fax: + 44 (0)522 510550

100 Smith Street,
Farmingdale,
N Y 11735
USA
Tel + 1 516 293 8636
Fax + 1 516 293 0061

2 Rue Henri-Bergson,
92600 Asnieres,
FRANCE
Tel: + 33 1 4080 5400
Fax + 33 1 4080 5587

Ungererstrasse 129,
80505 München,
GERMANY
Tel: + 49 (0)89 36 09 060
Telex. 523980
Fax: + 49 (0)89 36 09 06 55

Griensven 10,
Den Dungen (N Br),
5275 KE.
THE NETHERLANDS
Tel: + 31 (0)4194 1107
Fax: + 31 (0)4194 1119

These offices are supported by Representatives and Distributors in many countries world-wide.

This publication is issued to provide information only, which (unless agreed by the Company in writing) may not be used, applied or reproduced for any purpose nor form part of any order or contract, nor be regarded as a representation relating to the products or services concerned. No warranty or guarantee express or implied is made regarding the capability, performance or suitability of any product or service. The Company reserves the right to alter without prior knowledge the specification, design or price of any product or service. Information concerning possible methods of use is provided as a guide only and does not constitute any guarantee that such methods of use will be satisfactory in a specific piece of equipment. It is the users' responsibility to fully determine the performance and suitability of any equipment using such information and to ensure that any publication or data used is up to date and has not been superseded. These products are not suitable for use in medical products whose failure to perform may result in significant injury or death to the user. All products and materials are sold and services provided subject to the Company's conditions of sale, which are available on request. © GP04F4FDS/2.093