

BCR5AS

MEDIUM POWER USE

NON-INSULATED TYPE, PLANAR PASSIVATION TYPE

Refer to the page 6 as to the product guaranteed maximum junction temperature 150°C

BCR5AS



- **IT (RMS)** **5A**
- **VDRM** **600V**
- **IFGT I , IRGT I , IRGT III** **30mA**

OUTLINE DRAWING Dimensions in mm

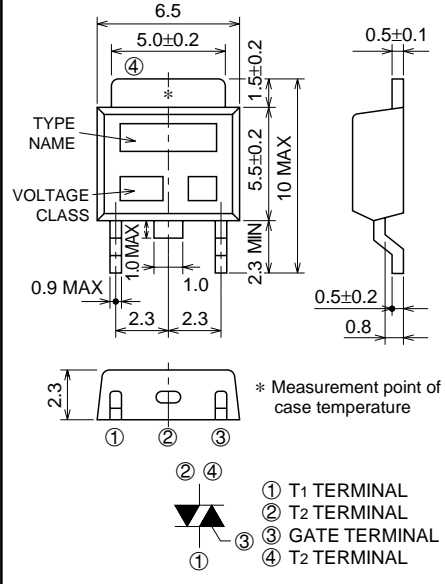

① T1 TERMINAL
② T2 TERMINAL
③ GATE TERMINAL
④ T2 TERMINAL

MP-3

APPLICATION

Hybrid IC, solid state relay, switching mode power supply, light dimmer, electric fan, electric blankets, control of household equipment such as washing machine, other general purpose control applications

MAXIMUM RATINGS

Symbol	Parameter	Voltage class		Unit
		12	600	
VDRM	Repetitive peak off-state voltage *1	600		V
VDSM	Non-repetitive peak off-state voltage *1	720		V

Symbol	Parameter	Conditions	Ratings	Unit
IT (RMS)	RMS on-state current	Commercial frequency, sine full wave 360° conduction, Tc=103°C*3	5	A
ITSM	Surge on-state current	60Hz sinewave 1 full cycle, peak value, non-repetitive	50	A
I ² t	I ² t for fusing	Value corresponding to 1 cycle of half wave 60Hz, surge on-state current	10.4	A ² s
PGM	Peak gate power dissipation		3	W
PG (AV)	Average gate power dissipation		0.3	W
VGM	Peak gate voltage		10	V
IGM	Peak gate current		2	A
Tj	Junction temperature		-40 ~ +125	°C
Tstg	Storage temperature		-40 ~ +125	°C
—	Weight	Typical value	0.26	g

*1. Gate open.

BCR5AS

Refer to the page 6 as to the product guaranteed maximum junction temperature 150°C

MEDIUM POWER USE
NON-INSULATED TYPE, PLANAR PASSIVATION TYPE

ELECTRICAL CHARACTERISTICS

Symbol	Parameter	Test conditions	Limits			Unit	
			Min.	Typ.	Max.		
IDRM	Repetitive peak off-state current	T _j =125°C, V _{DRM} applied	—	—	2.0	mA	
V _{TM}	On-state voltage	T _c =25°C, I _{TM} =7A, Instantaneous measurement	—	—	1.8	V	
V _{FGT I}	Gate trigger voltage *2	T _j =25°C, V _D =6V, R _L =6Ω, R _G =330Ω	I	—	—	1.5	V
V _{RGT I}			II	—	—	1.5	V
V _{RGT III}			III	—	—	1.5	V
I _{FGT I}	Gate trigger current *2	T _j =25°C, V _D =6V, R _L =6Ω, R _G =330Ω	I	—	—	30	mA
I _{RGT I}			II	—	—	30	mA
I _{RGT III}			III	—	—	30	mA
V _{GD}	Gate non-trigger voltage	T _j =125°C, V _D =1/2V _{DRM}	0.2	—	—	V	
R _{th (j-c)}	Thermal resistance	Junction to case *3	—	—	3.0	°C/W	
(dv/dt) _c	Critical-rate of rise of off-state commutating voltage *4	T _j =125°C	5	—	—	V/μs	

*2. Measurement using the gate trigger characteristics measurement circuit.

*3. Case temperature is measured on the T2 terminal.

*4. Test conditions of the critical-rate of rise of off-state commutating voltage is shown in the table below.

Test conditions	Commutating voltage and current waveforms (inductive load)
1. Junction temperature T _j =125°C 2. Rate of decay of on-state commutating current (di/dt) _c =-2.5A/ms 3. Peak off-state voltage V _D =400V	

PERFORMANCE CURVES

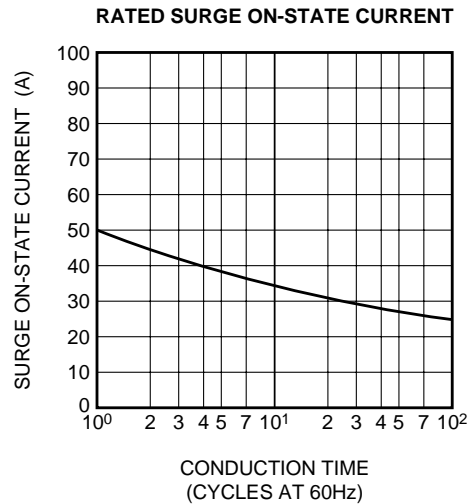
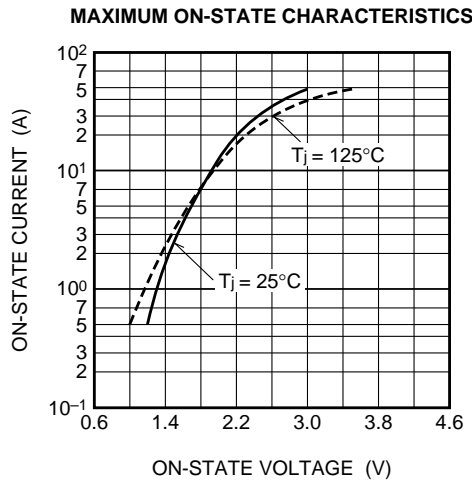

BCR5AS

Refer to the page 6 as to the product guaranteed maximum junction temperature 150°C

MEDIUM POWER USE
NON-INSULATED TYPE, PLANAR PASSIVATION TYPE

GATE CHARACTERISTICS (I, II AND III)

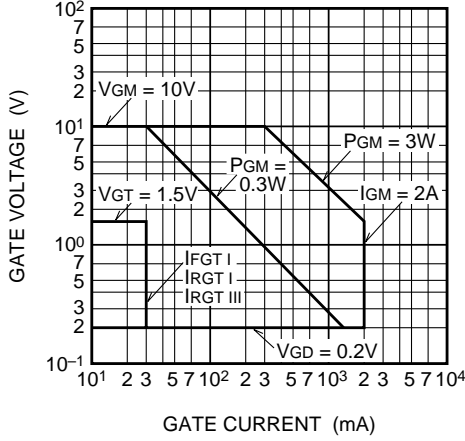

GATE TRIGGER CURRENT VS. JUNCTION TEMPERATURE

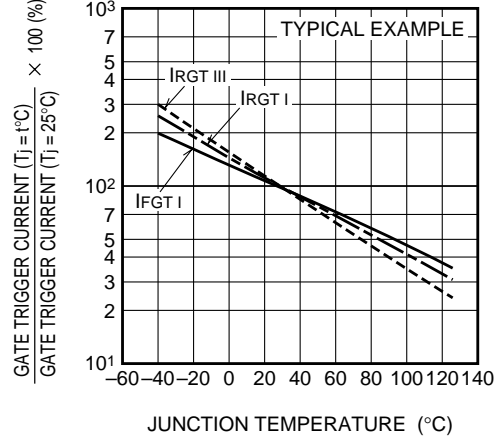

GATE TRIGGER VOLTAGE VS. JUNCTION TEMPERATURE

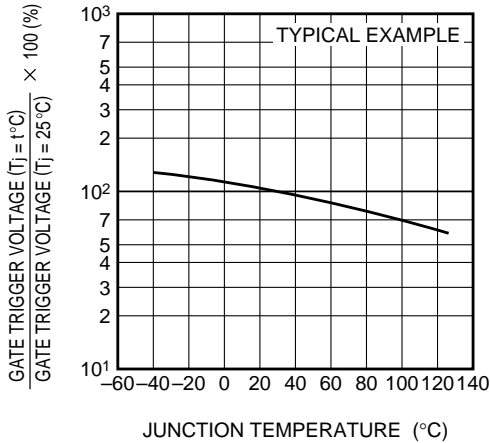

MAXIMUM TRANSIENT THERMAL IMPEDANCE CHARACTERISTICS (JUNCTION TO CASE)

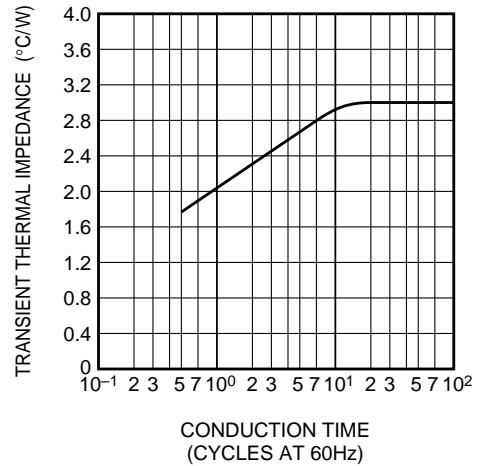

MAXIMUM ON-STATE POWER DISSIPATION

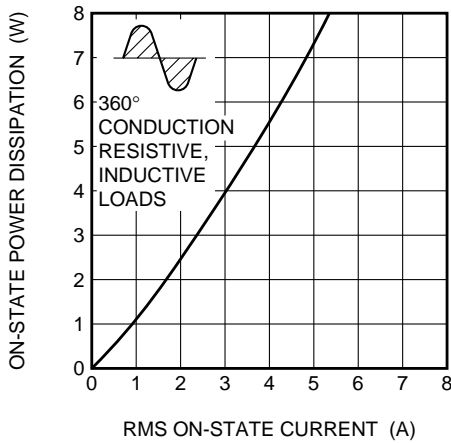

ALLOWABLE CASE TEMPERATURE VS. RMS ON-STATE CURRENT

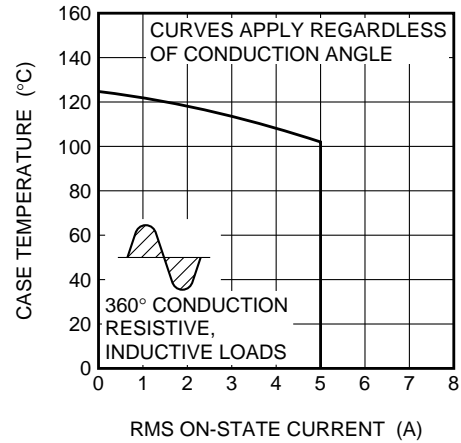

BCR5AS

Refer to the page 6 as to the product guaranteed maximum junction temperature 150°C

MEDIUM POWER USE
NON-INSULATED TYPE, PLANAR PASSIVATION TYPE

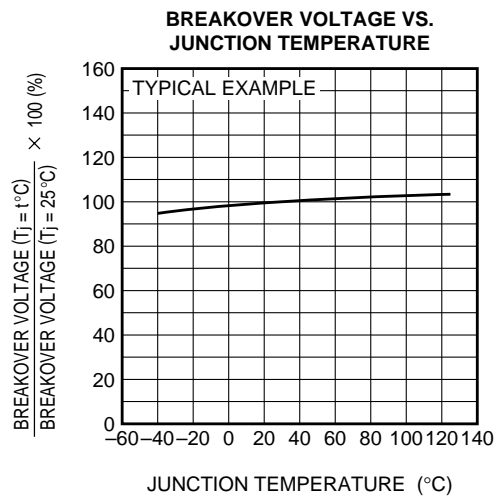
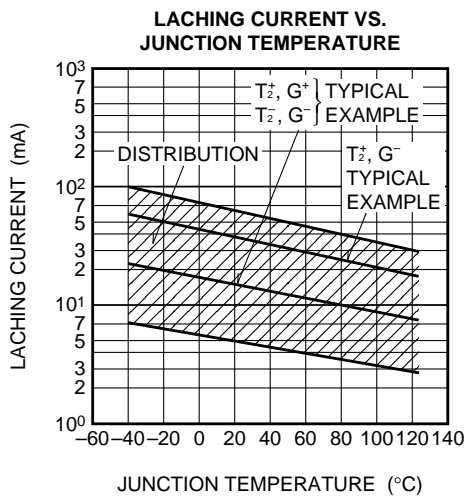
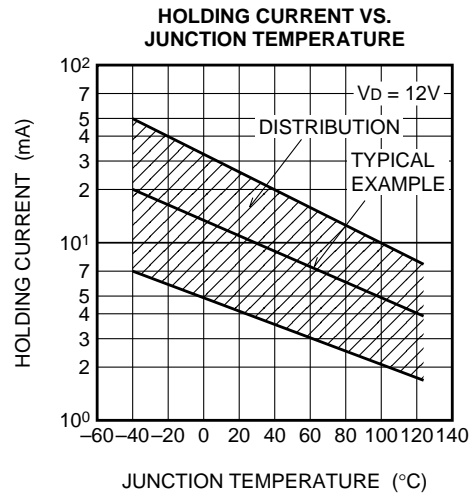
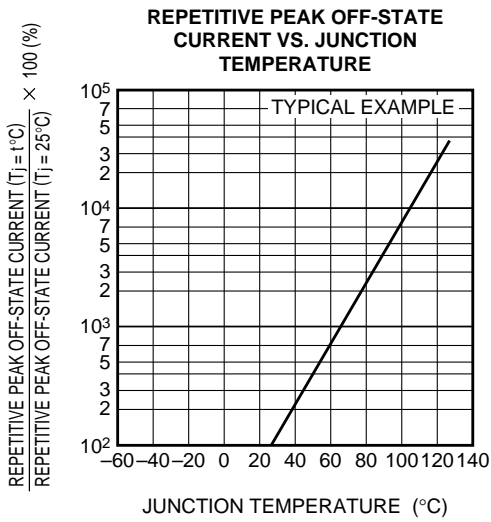
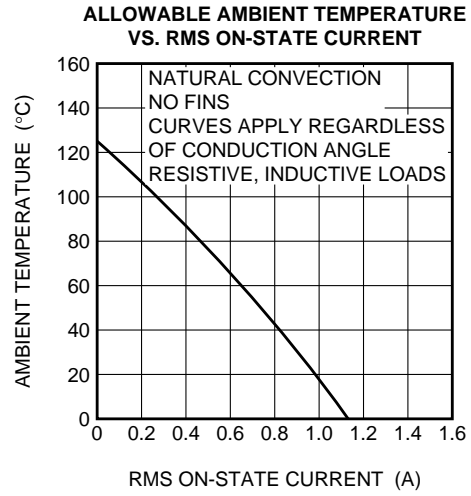
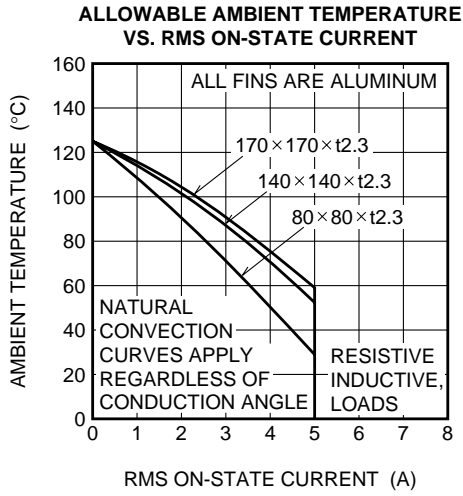

BCR5AS

Refer to the page 6 as to the product guaranteed maximum junction temperature 150°C

MEDIUM POWER USE
NON-INSULATED TYPE, PLANAR PASSIVATION TYPE

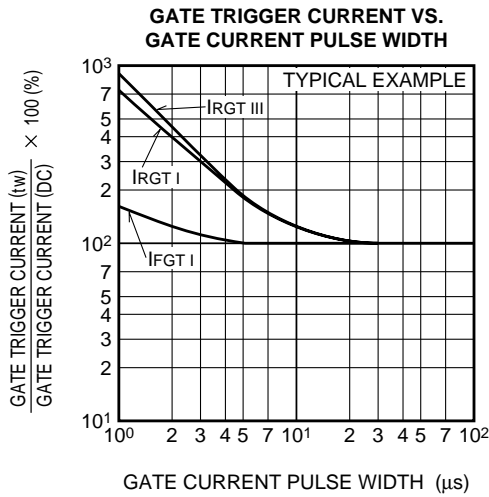
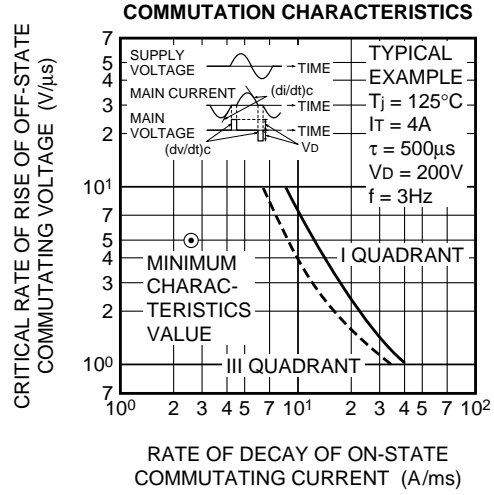
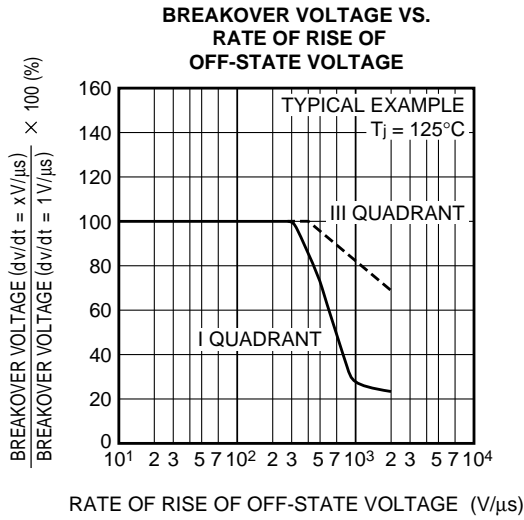

GATE TRIGGER CHARACTERISTICS TEST CIRCUITS

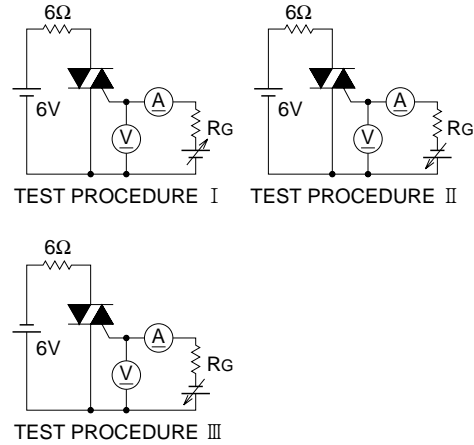

BCR5AS

MEDIUM POWER USE

NON-INSULATED TYPE, PLANAR PASSIVATION TYPE

The product guaranteed maximum junction temperature 150°C (See warning.)

BCR5AS



- **IT (RMS)** **5A**
- **VDRM** **600V**
- **IFGT I , IRGT I , IRGT III** **30mA**

OUTLINE DRAWING Dimensions in mm

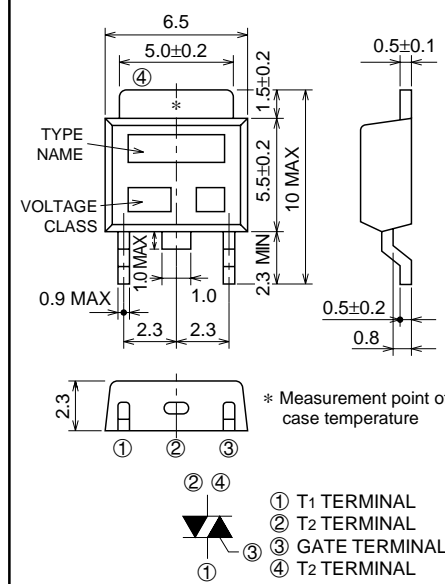

① T1 TERMINAL
② T2 TERMINAL
③ GATE TERMINAL
④ T2 TERMINAL

MP-3

APPLICATION

Hybrid IC, solid state relay, switching mode power supply, light dimmer, electric fan, electric blankets, control of household equipment such as washing machine, other general purpose control applications

(Warning)

1. Refer to the recommended circuit values around the triac before using.
2. Be sure to exchange the specification before using. If not exchanged, general triacs will be supplied.

MAXIMUM RATINGS

Symbol	Parameter	Voltage class		Unit
		12	600	
VDRM	Repetitive peak off-state voltage *1	600		V
VDSM	Non-repetitive peak off-state voltage *1	720		V

Symbol	Parameter	Conditions	Ratings	Unit
IT (RMS)	RMS on-state current	Commercial frequency, sine full wave 360° conduction, Tc=128°C*3	5	A
ITSM	Surge on-state current	60Hz sinewave 1 full cycle, peak value, non-repetitive	50	A
I ² t	I ² t for fusing	Value corresponding to 1 cycle of half wave 60Hz, surge on-state current	10.4	A ² s
PGM	Peak gate power dissipation		3	W
PG (AV)	Average gate power dissipation		0.3	W
VGM	Peak gate voltage		10	V
IGM	Peak gate current		2	A
Tj	Junction temperature		-40 ~ +150	°C
Tstg	Storage temperature		-40 ~ +150	°C
—	Weight	Typical value	0.26	g

*1. Gate open.

BCR5AS

The product guaranteed maximum junction temperature 150°C (See warning.)

MEDIUM POWER USE
NON-INSULATED TYPE, PLANAR PASSIVATION TYPE

ELECTRICAL CHARACTERISTICS

Symbol	Parameter	Test conditions	Limits			Unit	
			Min.	Typ.	Max.		
IDRM	Repetitive peak off-state current	T _j =150°C, V _{DRM} applied	—	—	2.0	mA	
V _{TM}	On-state voltage	T _c =25°C, I _{TM} =7A, Instantaneous measurement	—	—	1.8	V	
V _{FGT I}	Gate trigger voltage *2	T _j =25°C, V _D =6V, R _L =6Ω, R _G =330Ω	I	—	—	1.5	V
V _{RGT I}			II	—	—	1.5	V
V _{RGT III}			III	—	—	1.5	V
I _{FGT I}	Gate trigger current *2	T _j =25°C, V _D =6V, R _L =6Ω, R _G =330Ω	I	—	—	30	mA
I _{RGT I}			II	—	—	30	mA
I _{RGT III}			III	—	—	30	mA
V _{GD}	Gate non-trigger voltage	T _j =125°C/150°C, V _D =1/2V _{DRM}	0.2/0.1	—	—	V	
R _{th (j-c)}	Thermal resistance	Junction to case *3	—	—	3.0	°C/W	
(dv/dt) _c	Critical-rate of rise of off-state commutating voltage *4	T _j =125°/150°C	5/1	—	—	V/μs	

*2. Measurement using the gate trigger characteristics measurement circuit.

*3. Case temperature is measured on the T2 terminal.

*4. Test conditions of the critical-rate of rise of off-state commutating voltage is shown in the table below.

Test conditions	Commutating voltage and current waveforms (inductive load)
1. Junction temperature T _j =125°C/150°C 2. Rate of decay of on-state commutating current (di/dt) _c =-2.5A/ms 3. Peak off-state voltage V _D =400V	

PERFORMANCE CURVES

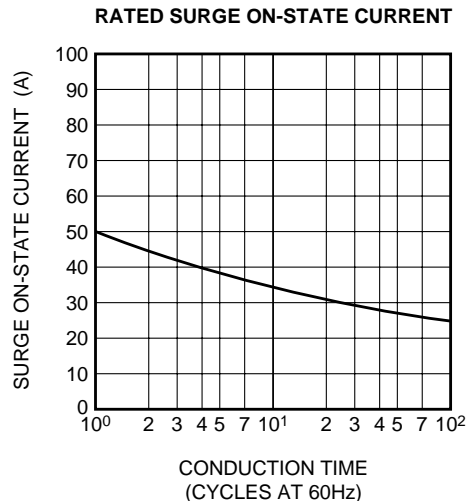
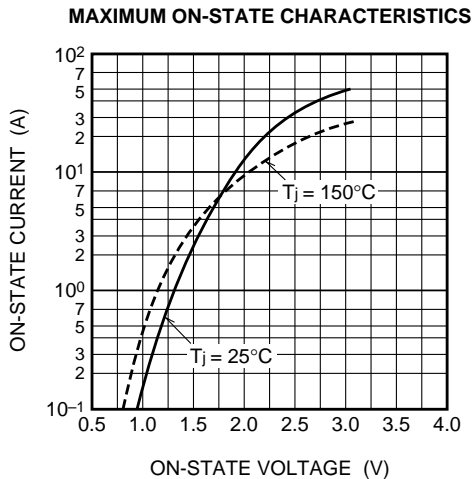

BCR5AS

The product guaranteed maximum junction temperature 150°C (See warning.)

MEDIUM POWER USE
NON-INSULATED TYPE, PLANAR PASSIVATION TYPE

GATE CHARACTERISTICS (I, II AND III)

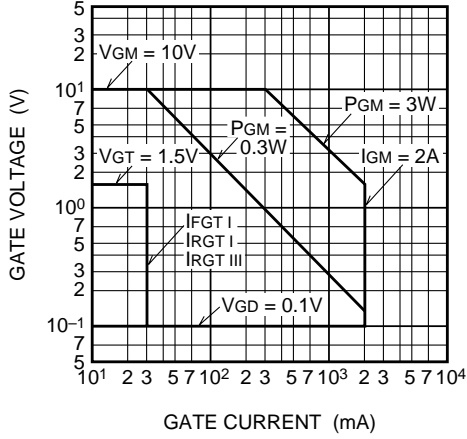

GATE TRIGGER CURRENT VS. JUNCTION TEMPERATURE

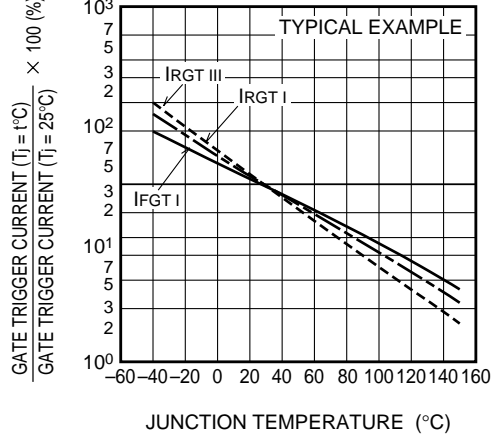

GATE TRIGGER VOLTAGE VS. JUNCTION TEMPERATURE

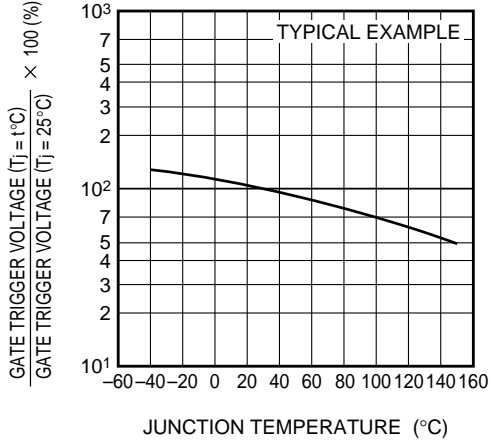

MAXIMUM TRANSIENT THERMAL IMPEDANCE CHARACTERISTICS (JUNCTION TO CASE)

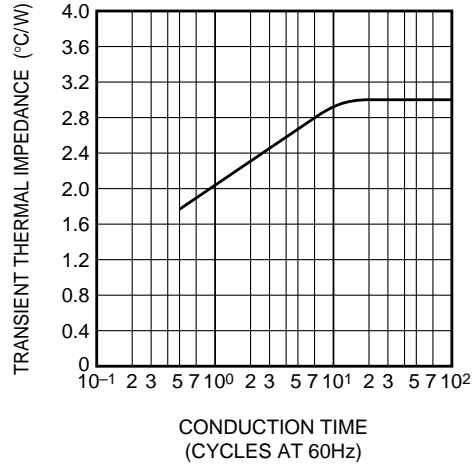

MAXIMUM ON-STATE POWER DISSIPATION

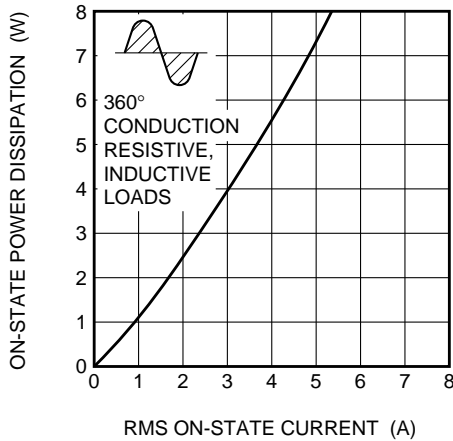

ALLOWABLE CASE TEMPERATURE VS. RMS ON-STATE CURRENT

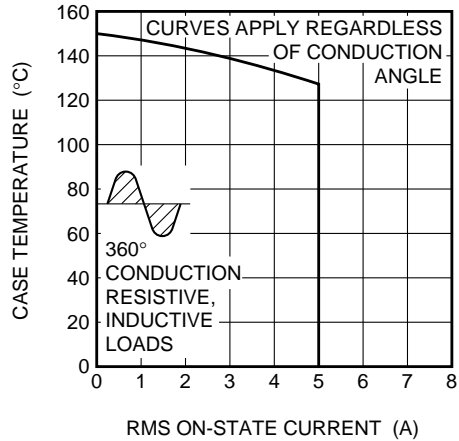

BCR5AS

The product guaranteed maximum junction temperature 150°C (See warning.)

MEDIUM POWER USE
NON-INSULATED TYPE, PLANAR PASSIVATION TYPE

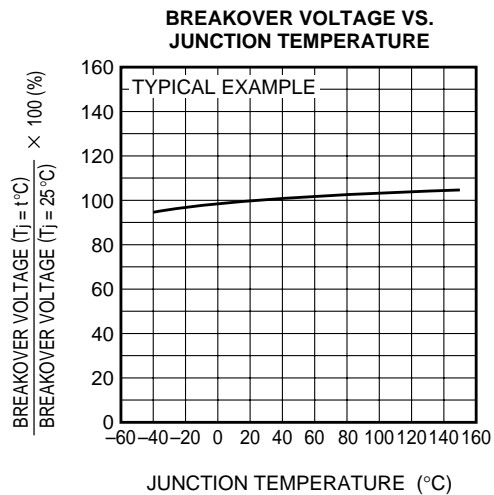
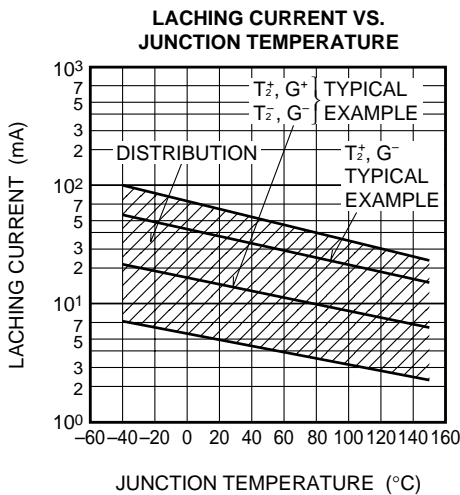
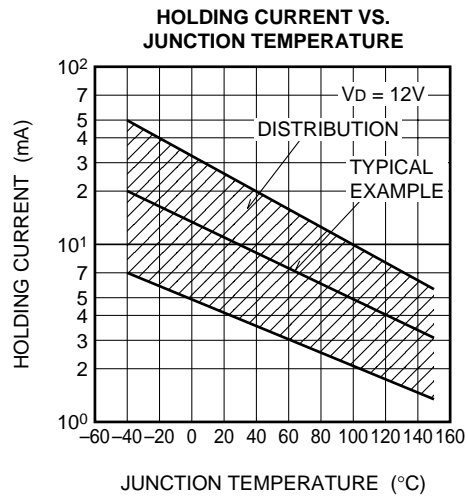
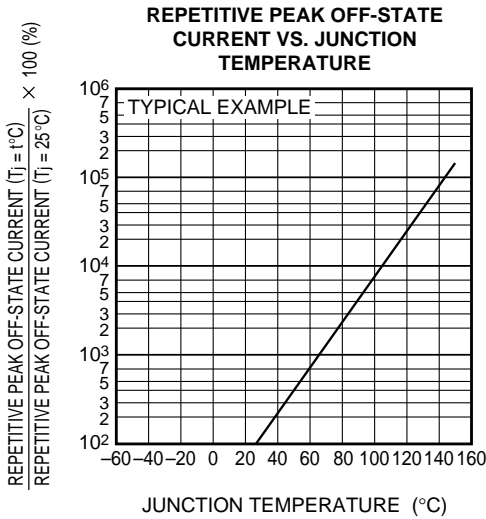
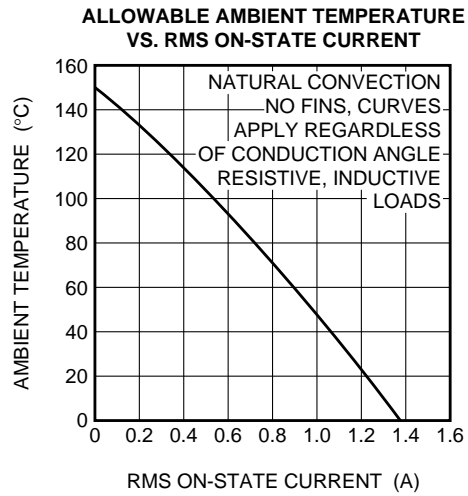
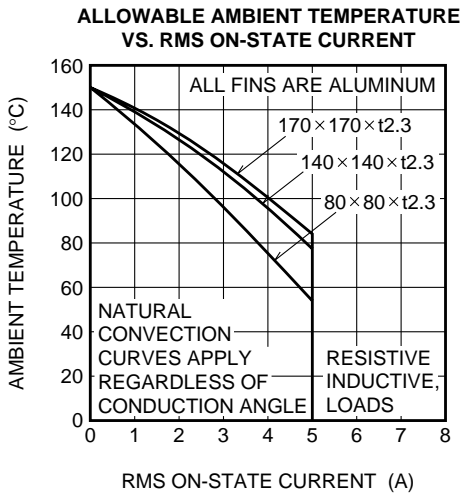

BCR5AS

The product guaranteed maximum junction temperature 150°C (See warning.)

MEDIUM POWER USE
NON-INSULATED TYPE, PLANAR PASSIVATION TYPE

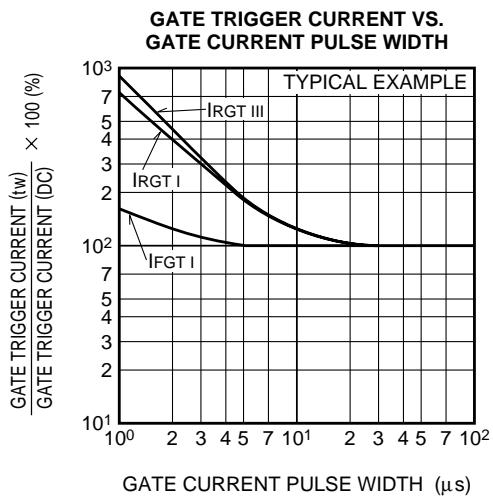
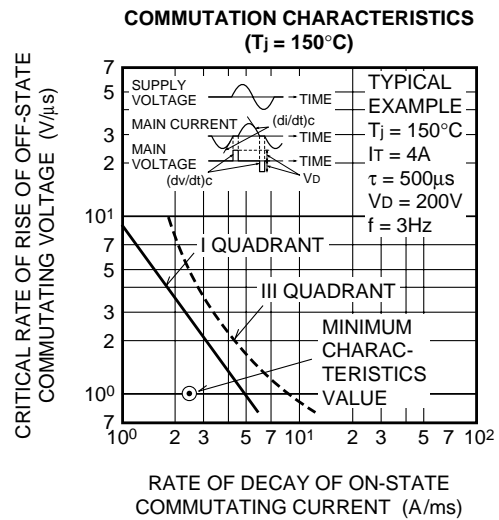
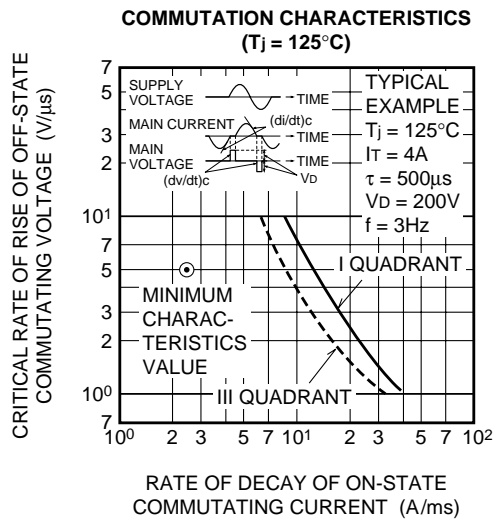
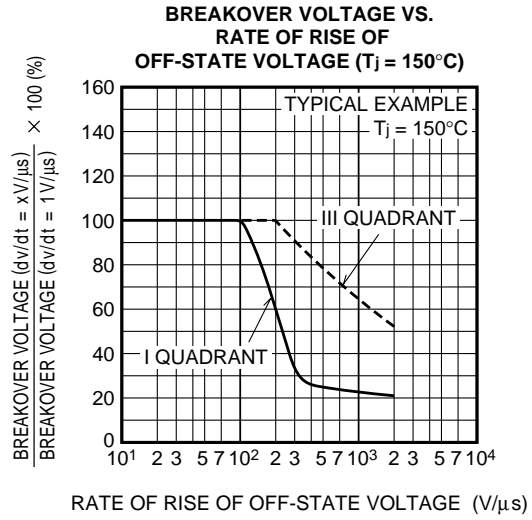
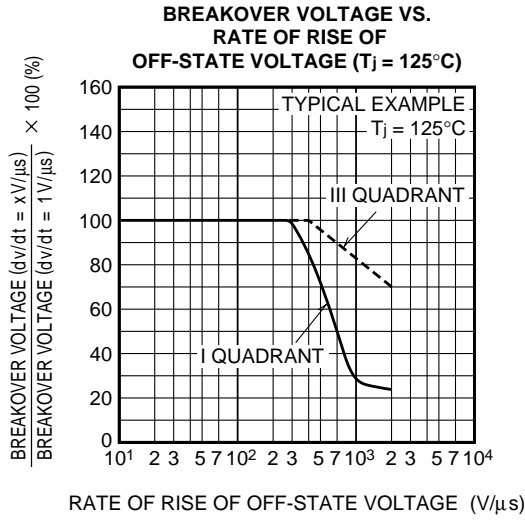

BCR5AS

The product guaranteed maximum junction temperature 150°C (See warning.)

MEDIUM POWER USE
NON-INSULATED TYPE, PLANAR PASSIVATION TYPE

GATE TRIGGER CHARACTERISTICS TEST CIRCUITS

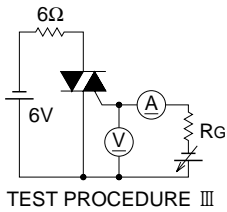
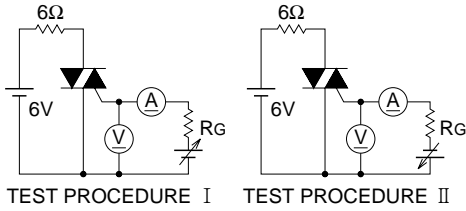

RECOMMENDED CIRCUIT VALUES AROUND THE TRIAC

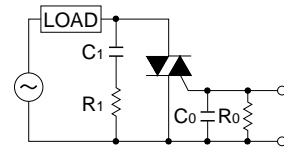

$C_1 = 0.1 \sim 0.47 \mu\text{F}$ $C_0 = 0.1 \mu\text{F}$
 $R_1 = 47 \sim 100 \Omega$ $R_0 = 100 \Omega$