

4N39X, 4N40X
4N39, 4N40



**PHOTON COUPLED ISOLATOR Ga As
INFRARED EMITTING DIODE &
LIGHT ACTIVATED SCR**

APPROVALS

- UL recognised, File No. E91231

'X' SPECIFICATION APPROVALS

- VDE 0884 in 2 available lead forms : -
- STD
- G form

DESCRIPTION

The 4N39, 4N40 are optically coupled isolators consisting of infrared light emitting diode and a light activated silicon controlled rectifier in a standard 6pin dual in line plastic package.

FEATURES

- Options :-
10mm lead spread - add G after part no.
Surface mount - add SM after part no.
Tape&reel - add SMT&R after part no.
- High Isolation Voltage (5.3kV_{RMS}, 7.5kV_{PK})
- High Surge Anode Current (5.0 A)
- High Blocking Voltage (200V*1, 400V*1)
- Low Turn on Current (5mA typical)
- All electrical parameters 100% tested
- Custom electrical selections available

APPLICATIONS

- 10A, TTL compatible, Solid State Relay
- 25W Logic Indicator Lamp Driver
- 400V Symmetrical transistor coupler

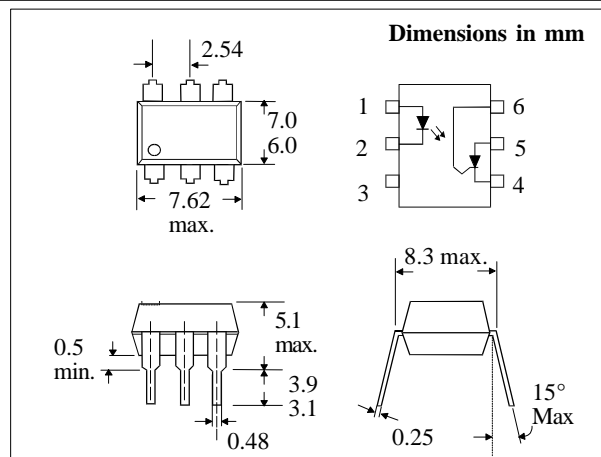
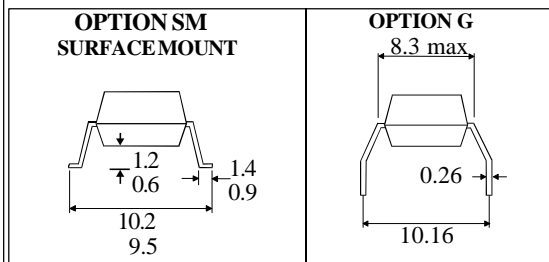

**ABSOLUTE MAXIMUM RATINGS
(25°C unless otherwise specified)**

Storage Temperature _____ -55°C to + 150°C
Operating Temperature _____ -55°C to + 100°C
Lead Soldering Temperature
(1/16 inch (1.6mm) from case for 10 secs) 260°C

INPUT DIODE

Forward Current _____ 60mA
Forward Current (Peak)
(1µs pulse, 300pps) _____ 3A
Reverse Voltage _____ 6V
Power Dissipation _____ 100mW

DETECTOR

Peak Forward Voltage
4N39 _____ 200V*1
4N40 _____ 400V*1
Peak Reverse Gate Voltage _____ 6V
RMS On-state Current _____ 300mA
Peak On-state Current
(100µs, 1% duty cycle) _____ 10A
Surge Current (10ms) _____ 5A
Power Dissipation _____ 300mW

*1 IMPORTANT : A resistor must be connected between gate and cathode (pins 4 & 6) to prevent false firing ($R_{GK} < 56k\Omega$)

ISOCOM COMPONENTS LTD
Unit 25B, Park View Road West,
Park View Industrial Estate, Brenda Road
Hartlepool, Cleveland, TS25 1YD
Tel: (01429) 863609 Fax : (01429) 863581

ISOCOM INC
1024 S. Greenville Ave, Suite 240,
Allen, TX 75002 USA
Tel: (214)495-0755 Fax: (214)495-0901
e-mail info@isocom.com
http://www.isocom.com

ELECTRICAL CHARACTERISTICS ($T_A = 25^\circ\text{C}$ Unless otherwise noted)

| PARAMETER | | MIN | TYP | MAX | UNITS | TEST CONDITION |
|--------------------|--|--------------|-----|----------|-----------------------|---|
| Input | Forward Voltage (V_F) | | 1.2 | 1.5 | V | $I_F = 10\text{mA}$ |
| | Reverse Voltage (V_R) | 3 | | | V | $I_R = 10\mu\text{A}$ |
| Output (note 2) | Peak Off-state Voltage (V_{DM}) 4N39 | 200 | | | V | $R_{GK}=10\text{k}\Omega, I_D=50\mu\text{A}, T_A=100^\circ\text{C}$ |
| | 4N40 | 400 | | | V | $R_{GK}=10\text{k}\Omega, I_D=150\mu\text{A}, T_A=100^\circ\text{C}$ |
| | Peak Reverse Voltage (V_{RM}) 4N39 | 200 | | | V | $R_{GK}=10\text{k}\Omega, I_D=50\mu\text{A}, T_A=100^\circ\text{C}$ |
| | 4N40 | 400 | | | V | $R_{GK}=10\text{k}\Omega, I_D=150\mu\text{A}, T_A=100^\circ\text{C}$ |
| | On-state Voltage (V_{TM}) | | 1.1 | 1.3 | V | $I_{TM} = 300\text{mA}$ |
| | Off-state Current (I_{DM}) 4N39 | | | 50 | μA | $R_{GK}=10\text{k}\Omega, I_F=0, V_{DM}=200\text{V}, T_A=100^\circ\text{C}$ |
| | 4N40 | | | 150 | μA | $R_{GK}=10\text{k}\Omega, I_F=0, V_{DM}=400\text{V}, T_A=100^\circ\text{C}$ |
| | Reverse Current (I_R) 4N39 | | | 50 | μA | $R_{GK}=10\text{k}\Omega, I_F=0, V_{DM}=200\text{V}, T_A=100^\circ\text{C}$ |
| | 4N40 | | | 150 | μA | $R_{GK}=10\text{k}\Omega, I_F=0, V_{DM}=400\text{V}, T_A=100^\circ\text{C}$ |
| | Holding Current (I_H) | | | 1 | mA | $R_{GK}=27\text{k}\Omega, V_{FX}=50\text{V}$ |
| Coupled | Input Current to Trigger (I_{FT}) (note 2) | | | 30 14 | mA mA | $V_{AK}=50\text{V}, R_{GK}=10\text{k}\Omega$ $V_{AK}=100\text{V}, R_{GK}=27\text{k}\Omega$ |
| | Turn on Time (t_{on}) | | | 50 | μs | $R_{GK}=10\text{k}\Omega, I_F=30\text{mA}, V_{AK}=50\text{V}, R_L=200\Omega$ |
| | Coupled dv/dt, Input to Output (dv/dt) | 500 | | | V/ μs | |
| | Input to Output Isolation Voltage V_{ISO} | 5300 7500 | | | V_{RMS} V_{PK} | See note 1 See note 1 |
| | Input-output Isolation Resistance R_{ISO} | 10^{11} | | | Ω | $V_{IO} = 500\text{V}$ (note 1) |
| | Input-output Capacitance C_f | | | 2 | pF | $V = 0, f = 1\text{MHz}$ |

Note 1 Measured with input leads shorted together and output leads shorted together.

Note 2 Special Selections are available on request. Please consult the factory.

Input Current to Trigger vs. Anode to Cathode Voltage

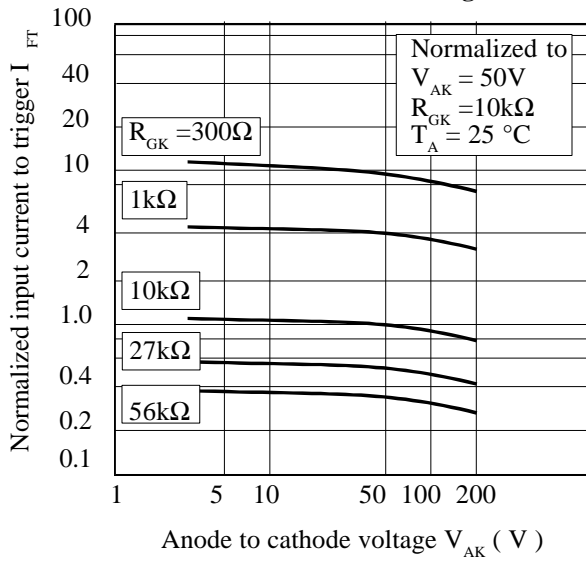

Input Current to Trigger vs. Ambient Temperature

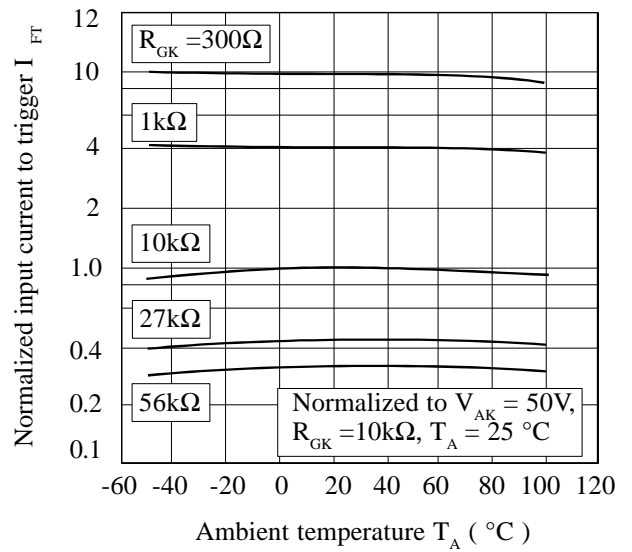

Input Current to Trigger Distribution vs. Ambient Temperature

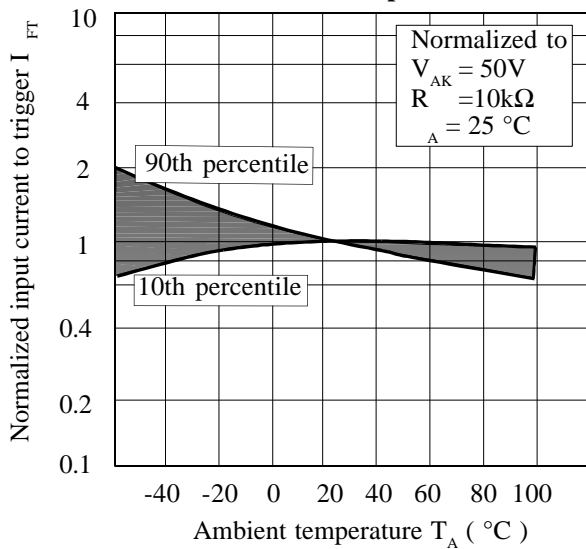

Input Current to Trigger vs. Pulse Width

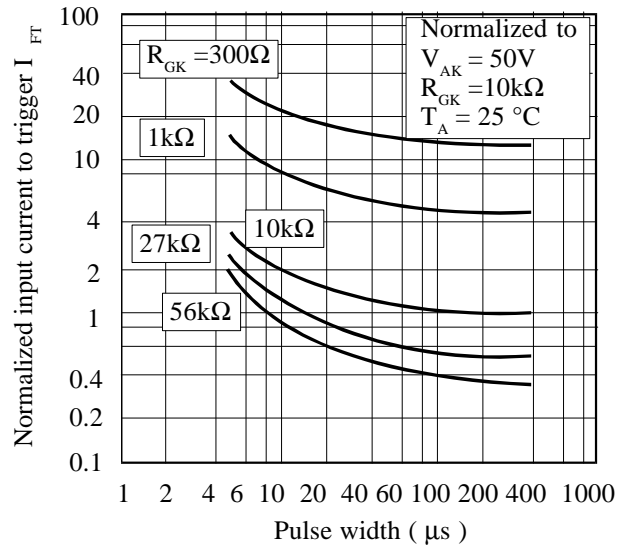

Turn on Time vs. Input Current

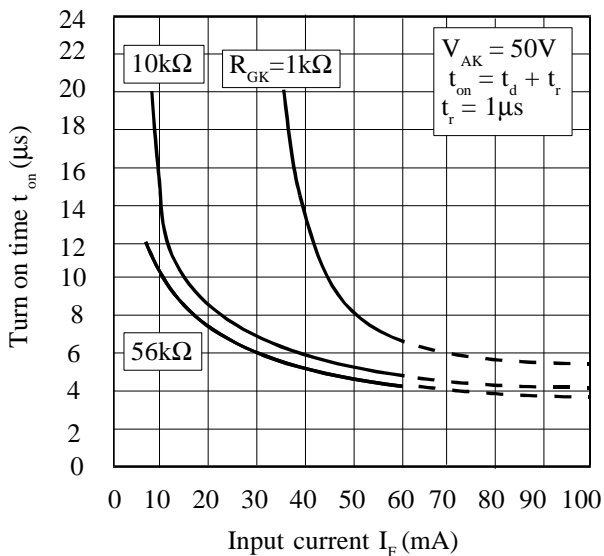

Input Characteristics I_F vs. V_F

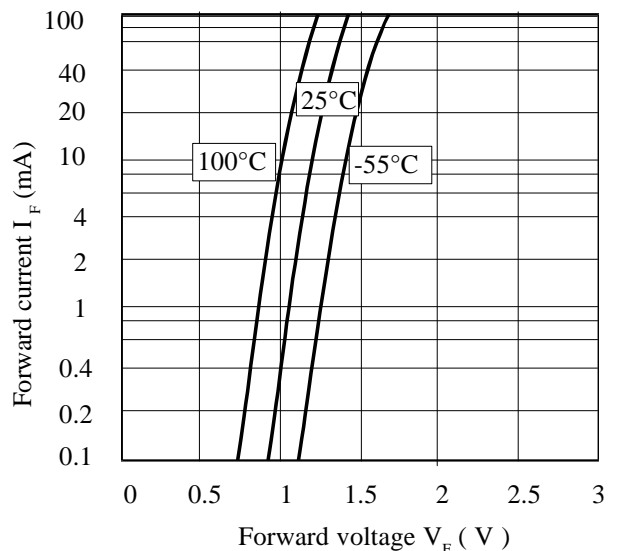

Holding Current vs. Ambient Temperature

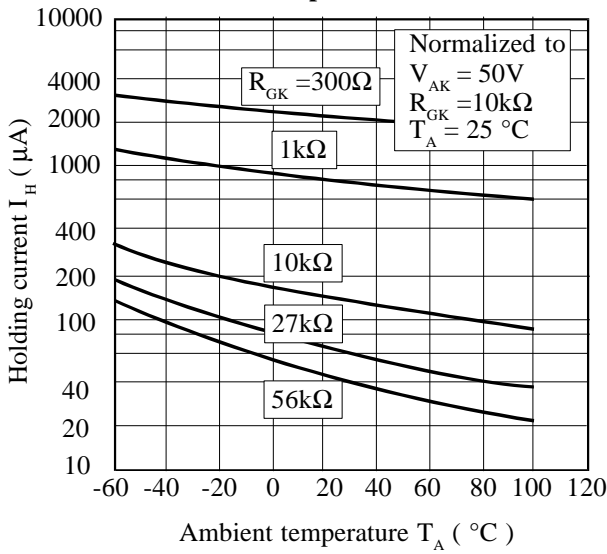

Maximum Transient Thermal Impedance

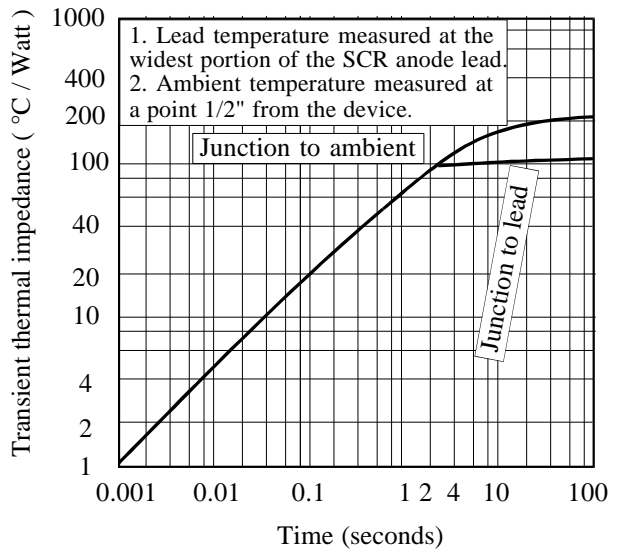

Off State Forward Current vs. Ambient Temperature

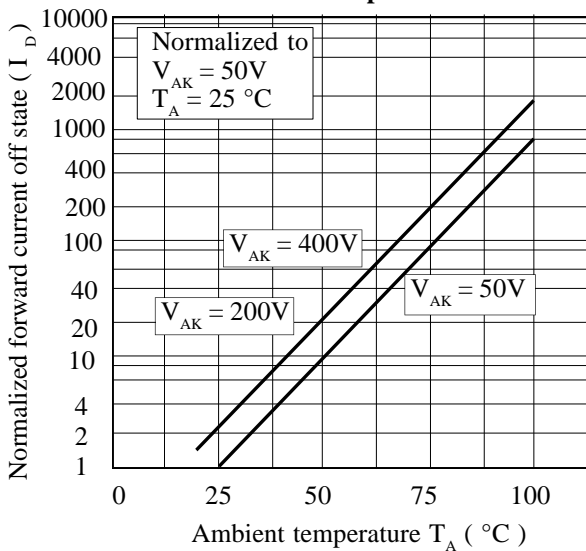

On State Current vs. Maximum Allowable Temperature

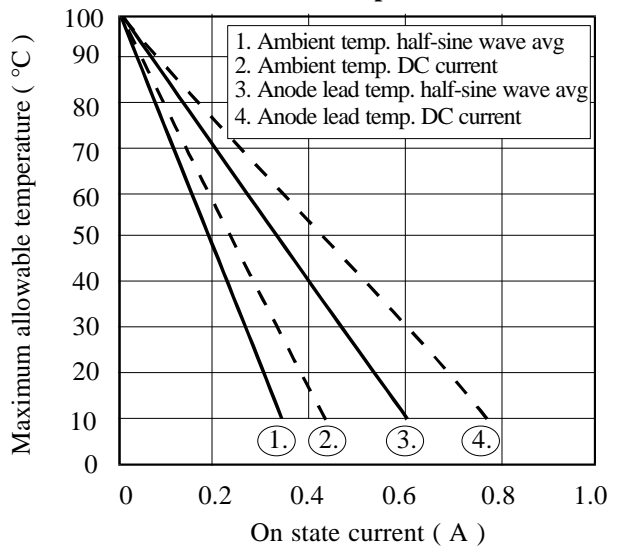

dV/dt vs. Ambient temperature

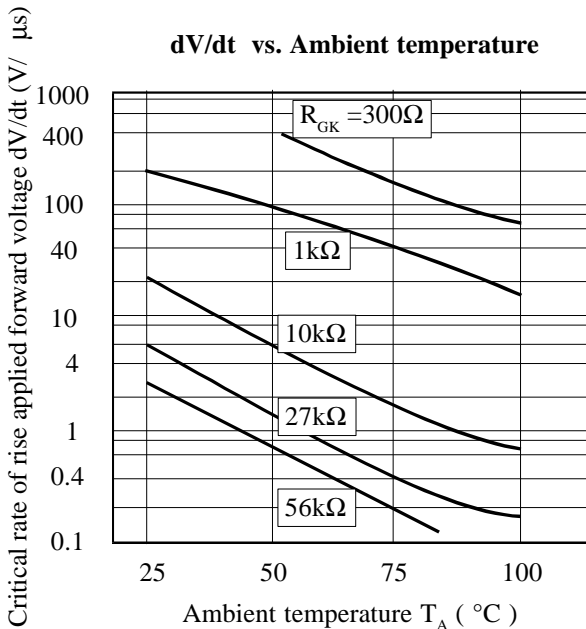

On State Characteristics

