

Multilayer Chip Beads / CP TYPE (Large Current)
Electrical Characteristics (CP160808 TYPE)

Part No.	IMPEDANCE ($\Omega \pm 25\%$)	Test frequency	DCR (Ω) Max	Rate Current (mA) Max
CP160808T-100□	10	100 MHZ,200 mV	0.02	4000
CP160808T-110□	11	100 MHZ,200 mV	0.02	4000
CP160808T-190□	19	100 MHZ,200 mV	0.03	3000
CP160808T-200□	20	100 MHZ,200 mV	0.03	3000
CP160808T-220□	22	100 MHZ,200 mV	0.03	3000
CP160808T-250□	25	100 MHZ,200 mV	0.03	3000
CP160808T-300□	30	100 MHZ,200 mV	0.03	3000
CP160808T-310□	31	100 MHZ,200 mV	0.035	3000
CP160808T-400□	40	100 MHZ,200 mV	0.035	3000
CP160808T-470□	47	100 MHZ,200 mV	0.04	3000
CP160808T-500□	50	100 MHZ,200 mV	0.04	3000
CP160808T-560□	56	100 MHZ,200 mV	0.04	3000
CP160808T-600□	60	100 MHZ,200 mV	0.04	3000
CP160808T-680□	68	100 MHZ,200 mV	0.05	2500
CP160808T-700□	70	100 MHZ,200 mV	0.05	2500
CP160808T-750□	75	100 MHZ,200 mV	0.05	2500
CP160808T-800□	80	100 MHZ,200 mV	0.05	2500
CP160808T-900□	90	100 MHZ,200 mV	0.05	2500
CP160808T-101□	100	100 MHZ,200 mV	0.05	2500
CP160808T-121□	120	100 MHZ,200 mV	0.08	2500
CP160808T-151□	150	100 MHZ,200 mV	0.085	2000
CP160808T-181□	180	100 MHZ,200 mV	0.09	2000
CP160808T-201□	200	100 MHZ,200 mV	0.095	2000
CP160808T-221□	220	100 MHZ,200 mV	0.1	2000
CP160808T-241□	240	100 MHZ,200 mV	0.12	1500
CP160808T-301□	300	100 MHZ,200 mV	0.12	1500
CP160808T-331□	330	100 MHZ,200 mV	0.12	1500
CP160808T-401□	400	100 MHZ,200 mV	0.12	1500
CP160808T-471□	470	100 MHZ,200 mV	0.15	1500
CP160808T-501□	500	100 MHZ,200 mV	0.15	1200
CP160808T-601□	600	100 MHZ,200 mV	0.2	1000
CP160808T-751□	750	100 MHZ,200 mV	0.25	800
CP160808T-102□	1000	100 MHZ,200 mV	0.25	800
CP160808T-152□	1500	100 MHZ,200 mV	0.4	500

Electrical Characteristics (CP201209 TYPE)

Part No.	IMPEDANCE ($\Omega \pm 25\%$)	Test frequency	DCR (Ω) Max	Rate Current (mA) Max
CP201209T-050□	5	100 MHZ,200 mV	0.01	6000
CP201209T-070□	7	100 MHZ,200 mV	0.01	6000

Multilayer Chip Beads / CP TYPE (Large Current)

Electrical Characteristics (CP201209 TYPE)

Part No.	IMPEDANCE ($\Omega \pm 25\%$)	Test frequency	DCR (Ω) Max	Rate Current (mA) Max
CP201209T-110□	11	100 MHZ,200 mV	0.01	6000
CP201209T-130□	13	100 MHZ,200 mV	0.02	5000
CP201209T-150□	15	100 MHZ,200 mV	0.02	5000
CP201209T-170□	17	100 MHZ,200 mV	0.02	5000
CP201209T-190□	19	100 MHZ,200 mV	0.02	4000
CP201209T-220□	22	100 MHZ,200 mV	0.02	4000
CP201209T-260□	26	100 MHZ,200 mV	0.02	4000
CP201209T-280□	28	100 MHZ,200 mV	0.02	4000
CP201209T-300□	30	100 MHZ,200 mV	0.02	4000
CP201209T-310□	31	100 MHZ,200 mV	0.02	4000
CP201209T-320□	32	100 MHZ,200 mV	0.02	4000
CP201209T-390□	39	100 MHZ,200 mV	0.02	3000
CP201209T-400□	40	100 MHZ,200 mV	0.02	3000
CP201209T-420□	42	100 MHZ,200 mV	0.025	3000
CP201209T-500□	50	100 MHZ,200 mV	0.025	3000
CP201209T-600□	60	100 MHZ,200 mV	0.03	3000
CP201209T-700□	70	100 MHZ,200 mV	0.04	3000
CP201209T-750□	75	100 MHZ,200 mV	0.04	3000
CP201209T-800□	80	100 MHZ,200 mV	0.04	3000
CP201209T-900□	90	100 MHZ,200 mV	0.04	3000
CP201209T-101□	100	100 MHZ,200 mV	0.04	3000
CP201209T-121□	120	100 MHZ,200 mV	0.04	3000
CP201209T-131□	130	100 MHZ,200 mV	0.05	2500
CP201209T-151□	150	100 MHZ,200 mV	0.05	2500
CP201209T-181□	180	100 MHZ,200 mV	0.05	2500
CP201209T-201□	200	100 MHZ,200 mV	0.05	2500
CP201209T-221□	220	100 MHZ,200 mV	0.08	2000
CP201209T-241□	240	100 MHZ,200 mV	0.08	2000
CP201209T-251□	250	100 MHZ,200 mV	0.08	2000
CP201209T-301□	300	100 MHZ,200 mV	0.08	2000
CP201209T-331□	330	100 MHZ,200 mV	0.08	2000
CP201209T-391□	390	100 MHZ,200 mV	0.1	2000
CP201209T-401□	400	100 MHZ,200 mV	0.1	2000
CP201209T-451□	450	100 MHZ,200 mV	0.1	2000
CP201209T-471□	470	100 MHZ,200 mV	0.1	2000
CP201209T-501□	500	100 MHZ,200 mV	0.1	2000
CP201209T-601□	600	100 MHZ,200 mV	0.1	2000
CP201209T-751□	750	100 MHZ,200 mV	0.12	1500
CP201209T-102□	1000	100 MHZ,200 mV	0.12	1500
CP201209T-152□	1500	100 MHZ,200 mV	0.3	1000

Multilayer Chip Beads / CP TYPE (Large Current)
Electrical Characteristics (CP321611 TYPE)

Part No.	IMPEDANCE ($\Omega \pm 25\%$)	Test frequency	DCR (Ω) Max	Rate Current (mA) Max
CP321611T-080□	8	100 MHZ,200 mV	0.015	6000
CP321611T-110□	11	100 MHZ,200 mV	0.015	6000
CP321611T-190□	19	100 MHZ,200 mV	0.015	6000
CP321611T-260□	26	100 MHZ,200 mV	0.015	6000
CP321611T-300□	30	100 MHZ,200 mV	0.015	4000
CP321611T-310□	31	100 MHZ,200 mV	0.015	4000
CP321611T-320□	32	100 MHZ,200 mV	0.015	4000
CP321611T-350□	35	100 MHZ,200 mV	0.015	4000
CP321611T-400□	40	100 MHZ,200 mV	0.015	4000
CP321611T-420□	42	100 MHZ,200 mV	0.015	4000
CP321611T-500□	50	100 MHZ,200 mV	0.02	4000
CP321611T-520□	52	100 MHZ,200 mV	0.02	4000
CP321611T-600□	60	100 MHZ,200 mV	0.02	4000
CP321611T-680□	68	100 MHZ,200 mV	0.02	4000
CP321611T-700□	70	100 MHZ,200 mV	0.02	4000
CP321611T-800□	80	100 MHZ,200 mV	0.025	3000
CP321611T-900□	90	100 MHZ,200 mV	0.03	3000
CP321611T-101□	100	100 MHZ,200 mV	0.03	2500
CP321611T-121□	120	100 MHZ,200 mV	0.03	2500
CP321611T-151□	150	100 MHZ,200 mV	0.04	2000
CP321611T-201□	200	100 MHZ,200 mV	0.05	2000
CP321611T-221□	220	100 MHZ,200 mV	0.05	2000
CP321611T-301□	300	100 MHZ,200 mV	0.06	2000
CP321611T-401□	400	100 MHZ,200 mV	0.1	2000
CP321611T-501□	500	100 MHZ,200 mV	0.1	2000
CP321611T-601□	600	100 MHZ,200 mV	0.1	2000
CP321611T-102□	1000	50 MHZ,200 mV	0.15	1200
CP321611T-122□	1200	50 MHZ,200 mV	0.18	1000
CP321611T-152□	1500	50 MHZ,200 mV	0.2	800

Electrical Characteristics (CP451616 TYPE)

Part No.	IMPEDANCE ($\Omega \pm 25\%$)	Test frequency	DCR (Ω) Max	Rate Current (mA) Max
CP451616T-190□	19	100 MHZ,200 mV	0.02	6000
CP451616T-400□	40	100 MHZ,200 mV	0.02	6000
CP451616T-500□	50	100 MHZ,200 mV	0.02	6000
CP451616T-600□	60	100 MHZ,200 mV	0.02	5000
CP451616T-700□	70	100 MHZ,200 mV	0.025	5000
CP451616T-750□	75	100 MHZ,200 mV	0.025	5000
CP451616T-800□	80	100 MHZ,200 mV	0.025	4000
CP451616T-101□	100	100 MHZ,200 mV	0.1	2000
CP451616T-151□	150	100 MHZ,200 mV	0.1	2000

Multilayer Chip Beads / CP TYPE (Large Current)

Electrical Characteristics (CP451616 TYPE)

Part No.	IMPEDANCE ($\Omega \pm 25\%$)	Test frequency	DCR (Ω) Max	Rate Current (mA) Max
CP451616T-191□	190	100 MHZ, 200 mV	0.1	2000
CP451616T-301□	300	100 MHZ, 200 mV	0.1	2000
CP451616T-601□	600	100 MHZ, 200 mV	0.1	2000
CP451616T-102□	1000	100 MHZ, 200 mV	0.1	2000
CP451616T-132□	1300	100 MHZ, 200 mV	0.1	2000

Electrical Characteristics (CP453215 TYPE)

Part No.	IMPEDANCE ($\Omega \pm 25\%$)	Test frequency	DCR (Ω) Max	Rate Current (mA) Max
CP453215T-190□	19	100 MHZ, 200 mV	0.03	6000
CP453215T-300□	30	100 MHZ, 200 mV	0.03	6000
CP453215T-470□	47	100 MHZ, 200 mV	0.03	6000
CP453215T-500□	50	100 MHZ, 200 mV	0.03	6000
CP453215T-600□	60	100 MHZ, 200 mV	0.03	6000
CP453215T-700□	70	100 MHZ, 200 mV	0.03	6000
CP453215T-800□	80	100 MHZ, 200 mV	0.03	4000
CP453215T-900□	90	100 MHZ, 200 mV	0.03	4000
CP453215T-121□	120	100 MHZ, 200 mV	0.03	4000
CP453215T-125□	125	100 MHZ, 200 mV	0.03	4000
CP453215T-151□	150	100 MHZ, 200 mV	0.03	4000
CP453215T-191□	190	100 MHZ, 200 mV	0.03	4000

NOTE:

1. Operating temperature range $-55^{\circ}\text{C} \sim 125^{\circ}\text{C}$
2. Rate Current : Applied the current to coils, the temperature rise shall not be more than 30°C
3. Rate Current is deRate as left figure depending on the operating temprature.
4. □Tolerance : J=5% ; K=10% ; M=20% ; Y=25% ; N=30%

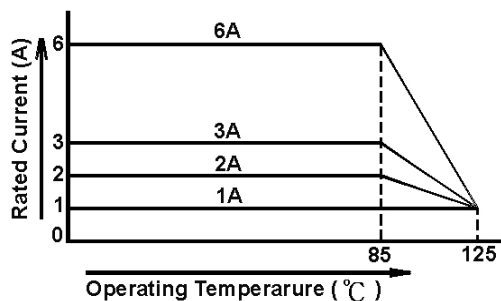

Multilayer Chip Beads / CP TYPE (Large Current)

4. Reliability and Test Conditions(可靠性測試條件)

1-1.Mechanical Performance

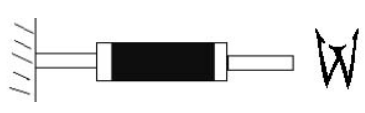
Item	Specification	Test Method
Flexure Strength	The forces applied on the right conditions must not damage the terminal electrode and the ferrite	Test device shall be soldered on the substrate Substrate Dimension: 100x40x1.6mm Deflection: 2.0mm Keeping Time: 30sec *For 100505, substrate dimension is 100x40x0.8mm
Vibration		Test device shall be soldered on the substrate Oscillation Frequency: 10 to 55 to 10Hz for 1min Amplitude: 1.5mm Time: 2hrs for each axis (X, Y & Z), total 6hrs
Resistance to Soldering Heat	Appearance: No damage More than 75% of the terminal electrode should be covered with solder. Impedance : within $\pm 30\%$ of initial value	Pre-heating: 150°C, 1min Solder Composition: Sn/Pb = 63/37 Solder Composition: Sn/Ag3.0/Cu0.5(Pb-Free) Solder Temperature: 260 ± 5 °C Immersion Time: 10 ± 1 sec
Solder ability	The electrodes shall be at least 90% covered with new solder coating	Pre-heating: 150°C, 1min Solder Composition: Sn/Pb = 63/37 Solder Temperature: 220 ± 5 °C Solder Composition: Sn/Ag3.0/Cu0.5(Pb-Free) Solder Temperature: 245 ± 5 °C (Pb-Free) Immersion Time: 4 ± 1 sec
Terminal Strength Test	100505 series : ≥ 0.2 kg 160808 series : ≥ 0.5 kg 201209 series : ≥ 1.0 kg other series : ≥ 2.0 kg BAY/BAQ321609 series: ≥ 1.5 kg (Push)	Test device shall be soldered on the substrate 

Item	Specification	Test Method															
Temperature Cycle	Appearance: No damage Impedance: within $\pm 30\%$ of initial value	One cycle: <table border="1"> <thead> <tr> <th>Step</th> <th>Temperature (°C)</th> <th>Time (min)</th> </tr> </thead> <tbody> <tr> <td>1</td> <td>-55± 3</td> <td>30</td> </tr> <tr> <td>2</td> <td>25± 2</td> <td>3</td> </tr> <tr> <td>3</td> <td>125± 3</td> <td>30</td> </tr> <tr> <td>4</td> <td>25± 2</td> <td>3</td> </tr> </tbody> </table> Total: 100cycles Measured after exposure in the room condition for 24hrs	Step	Temperature (°C)	Time (min)	1	-55 ± 3	30	2	25 ± 2	3	3	125 ± 3	30	4	25 ± 2	3
Step		Temperature (°C)	Time (min)														
1		-55 ± 3	30														
2		25 ± 2	3														
3	125 ± 3	30															
4	25 ± 2	3															
Humidity Resistance	Temperature: 40 ± 2 °C Relative Humidity: 90 ~ 95% / Time: 1000hrs Measured after exposure in the room condition for 24hrs																
High Temperature Resistance	Temperature: 125 ± 3 °C / Relative Humidity: 0% Applied Current: Rated Current /Time: 1000hrs Measured after exposure in the room condition for 24hrs																
Low Temperature Resistance	Temperature: -55 ± 3 °C Relative Humidity: 0% / Time: 1000hrs Measured after exposure in the room condition for 24hrs																

Multilayer Chip Beads / CP TYPE (Large Current)

.Packing Specifications

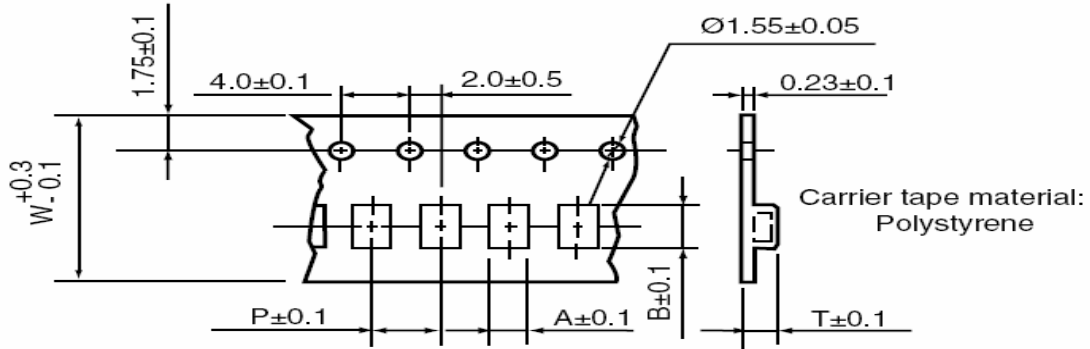

TYPE	Packaging Quantity		Tape Dimension				
	Pcs / Reel	Inner box	A	B	W	P	T
CP160808	4000	20000	1.08	1.88	8	4	1.05
CP201209	4000	20000	1.42	2.24	8	4	1.04
CP321611	3000	15000	1.88	3.5	8	4	1.27
CP451616	2000	8000	1.93	4.95	12	4	1.93
CP453215	1000	4000	3.66	4.95	12	8	1.83

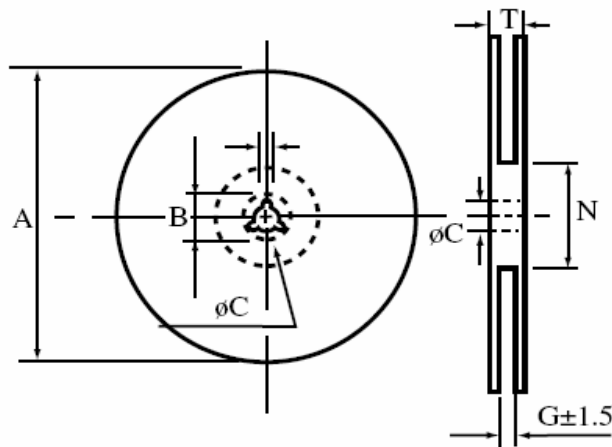

TYPE	Reel Dimension					
	A	B	C	G	N	T
8mm	178±2	21.0±0.8	13.0±0.8	10	75	12.5
12mm	178±2	21.0±0.8	13.0±0.8	14	75	16.5

Multilayer Chip Beads / CB TYPE

.Features:

- 1.Closed magnetic circuit avoids crosstalk.
- 2.S.M.T. type.
- 3.Excellent solderability and heat resistance.
- 4.High reliability.
- 5.The products contain no lead and also support lead-free soldering.

.Applications:

Prevention of high frequency EMI form computers, printers, VCRs, TVs, wireless telephone and other related equipment.

.Product Identification :

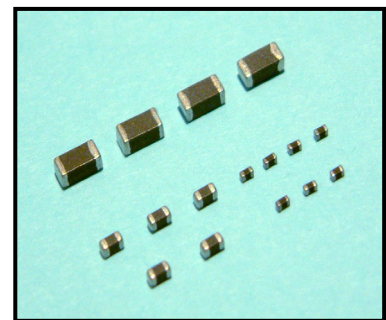
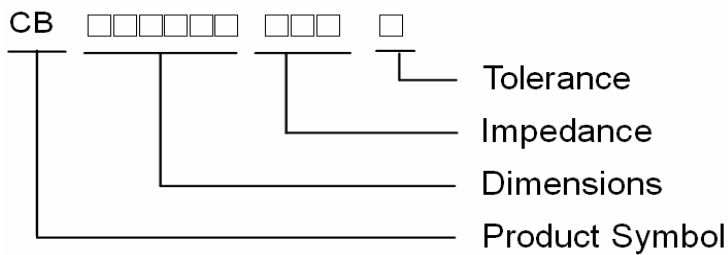

.Shape and Dimension

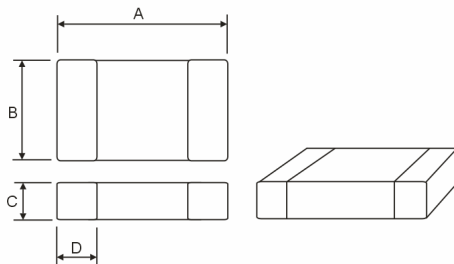

.Schematic

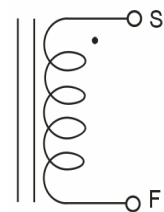

Dimensions in mm

TYPE	A(mm)	B(mm)	C(mm)	D(mm)
CB100505	1.0±0.1	0.5±0.1	0.5±0.1	0.25±0.1
CB160808	1.6±0.2	0.8±0.15	0.8±0.15	0.3±0.2
CB201209	2.0±0.2	1.25±0.2	0.9±0.2	0.5±0.3
CB321611	3.2±0.2	1.6±0.2	1.1±0.2	0.5±0.3
CB451616	4.5±0.25	1.6±0.2	1.6±0.2	0.5±0.3

.Recommended Reflow

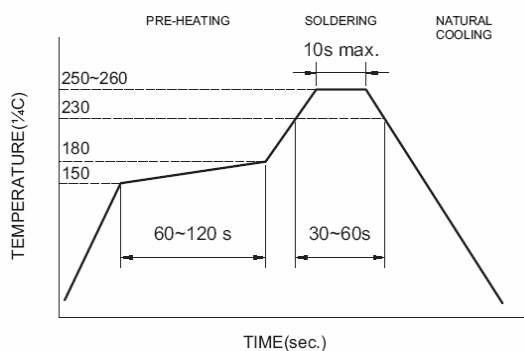

Multilayer Chip Beads / CB TYPE

Electrical Characteristics (CB100505 TYPE)

Part No.	IMPEDANCE ($\Omega \pm 25\%$)	Test frequency	DCR (Ω) Max	Rated Current (mA) Max
CB100505T-060□	6	100 MHZ,200 mV	0.05	500
CB100505T-100□	10	100 MHZ,200 mV	0.05	500
CB100505T-300□	30	100 MHZ,200 mV	0.3	300
CB100505T-400□	40	100 MHZ,200 mV	0.3	300
CB100505T-470□	47	100 MHZ,200 mV	0.4	300
CB100505T-600□	60	100 MHZ,200 mV	0.4	300
CB100505T-700□	70	100 MHZ,200 mV	0.4	300
CB100505T-750□	75	100 MHZ,200 mV	0.4	300
CB100505T-800□	80	100 MHZ,200 mV	0.4	300
CB100505T-121□	120	100 MHZ,200 mV	0.5	300
CB100505T-151□	150	100 MHZ,200 mV	0.5	300
CB100505T-221□	220	100 MHZ,200 mV	0.5	300
CB100505T-241□	240	100 MHZ,200 mV	0.5	300
CB100505T-301□	300	100 MHZ,200 mV	0.8	300
CB100505T-481□	480	100 MHZ,200 mV	0.8	300
CB100505T-601□	600	100 MHZ,200 mV	1	300
CB100505T-102□	1000	100 MHZ,200 mV	1.5	100
CB100505T-152□	1500	100 MHZ,200 mV	2	60

Electrical Characteristics (CB160808 TYPE)

Part No.	IMPEDANCE ($\Omega \pm 25\%$)	Test frequency	DCR (Ω) Max	Rated Current (mA) Max
CB160808T-060□	6	100 MHZ,200 mV	0.05	500
CB160808T-070□	7	100 MHZ,200 mV	0.05	500
CB160808T-100□	10	100 MHZ,200 mV	0.05	500
CB160808T-110□	11	100 MHZ,200 mV	0.05	500
CB160808T-150□	15	100 MHZ,200 mV	0.08	500
CB160808T-170□	17	100 MHZ,200 mV	0.08	500
CB160808T-190□	19	100 MHZ,200 mV	0.08	500
CB160808T-220□	22	100 MHZ,200 mV	0.1	400
CB160808T-250□	25	100 MHZ,200 mV	0.1	400
CB160808T-260□	26	100 MHZ,200 mV	0.1	400
CB160808T-300□	30	100 MHZ,200 mV	0.1	400
CB160808T-310□	31	100 MHZ,200 mV	0.1	400
CB160808T-400□	40	100 MHZ,200 mV	0.1	400
CB160808T-470□	47	100 MHZ,200 mV	0.1	300
CB160808T-500□	50	100 MHZ,200 mV	0.1	300
CB160808T-600□	60	100 MHZ,200 mV	0.1	300
CB160808T-680□	68	100 MHZ,200 mV	0.15	300
CB160808T-700□	70	100 MHZ,200 mV	0.15	300
CB160808T-750□	75	100 MHZ,200 mV	0.15	300

Multilayer Chip Beads / CB TYPE

Electrical Characteristics (CB160808 TYPE)

Part No.	IMPEDANCE ($\Omega \pm 25\%$)	Test frequency	DCR (Ω) Max	Rated Current (mA) Max
CB160808T-800□	80	100 MHZ,200 mV	0.15	300
CB160808T-900□	90	100 MHZ,200 mV	0.2	300
CB160808T-101□	100	100 MHZ,200 mV	0.2	300
CB160808T-121□	120	100 MHZ,200 mV	0.25	400
CB160808T-151□	150	100 MHZ,200 mV	0.3	200
CB160808T-181□	180	100 MHZ,200 mV	0.3	200
CB160808T-201□	200	100 MHZ,200 mV	0.3	200
CB160808T-221□	220	100 MHZ,200 mV	0.3	200
CB160808T-241□	240	100 MHZ,200 mV	0.4	200
CB160808T-301□	300	100 MHZ,200 mV	0.4	200
CB160808T-331□	330	100 MHZ,200 mV	0.5	200
CB160808T-451□	450	100 MHZ,200 mV	0.5	200
CB160808T-471□	470	100 MHZ,200 mV	0.5	200
CB160808T-501□	500	100 MHZ,200 mV	0.5	200
CB160808T-601□	600	100 MHZ,200 mV	0.5	200
CB160808T-751□	750	100 MHZ,200 mV	0.7	200
CB160808T-102□	1000	100 MHZ,200 mV	0.7	200
CB160808T-122□	1200	100 MHZ,200 mV	1	50
CB160808T-152□	1500	100 MHZ,200 mV	1	50
CB160808T-202□	2000	100 MHZ,200 mV	1.2	50
CB160808T-222□	2200	100 MHZ,200 mV	1.2	50
CB160808T-252□	2500	100 MHZ,200 mV	1.3	50
CB160808T-272□	2700	100 MHZ,200 mV	1.3	50

Electrical Characteristics (CB201209 TYPE)

Part No.	IMPEDANCE ($\Omega \pm 25\%$)	Test frequency	DCR (Ω) Max	Rated Current (mA) Max
CB201209T-600□	60	100 MHZ,200 mV	0.15	500
CB201209T-700□	70	100 MHZ,200 mV	0.15	500
CB201209T-750□	75	100 MHZ,200 mV	0.15	500
CB201209T-800□	80	100 MHZ,200 mV	0.15	500
CB201209T-900□	90	100 MHZ,200 mV	0.15	500
CB201209T-950□	95	100 MHZ,200 mV	0.15	500
CB201209T-101□	100	100 MHZ,200 mV	0.25	300
CB201209T-121□	120	100 MHZ,200 mV	0.25	300
CB201209T-151□	150	100 MHZ,200 mV	0.25	300
CB201209T-181□	180	100 MHZ,200 mV	0.3	300
CB201209T-201□	200	100 MHZ,200 mV	0.3	300
CB201209T-221□	220	100 MHZ,200 mV	0.3	300
CB201209T-241□	240	100 MHZ,200 mV	0.3	300
CB201209T-301□	300	100 MHZ,200 mV	0.3	300
CB201209T-331□	330	100 MHZ,200 mV	0.3	300

Multilayer Chip Beads / CB TYPE

Electrical Characteristics (CB201209 TYPE)

Part No.	IMPEDANCE ($\Omega \pm 25\%$)	Test frequency	DCR (Ω) Max	Rated Current (mA) Max
CB201209T-401□	400	100 MHZ,200 mV	0.3	300
CB201209T-421□	420	100 MHZ,200 mV	0.3	300
CB201209T-431□	430	100 MHZ,200 mV	0.4	300
CB201209T-451□	450	100 MHZ,200 mV	0.4	300
CB201209T-471□	470	100 MHZ,200 mV	0.4	300
CB201209T-501□	500	100 MHZ,200 mV	0.4	300
CB201209T-601□	600	100 MHZ,200 mV	0.4	300
CB201209T-681□	680	100 MHZ,200 mV	0.4	300
CB201209T-751□	750	100 MHZ,200 mV	0.5	200
CB201209T-102□	1000	100 MHZ,200 mV	0.5	200
CB201209T-122□	1200	100 MHZ,200 mV	0.6	200
CB201209T-152□	1500	100 MHZ,200 mV	0.6	200
CB201209T-202□	2000	100 MHZ,200 mV	0.8	100
CB201209T-222□	2200	100 MHZ,200 mV	1	100
CB201209T-252□	2500	100 MHZ,200 mV	1	100
CB201209T-272□	2700	100 MHZ,200 mV	1.5	100

Electrical Characteristics (CB321611 TYPE)

Part No.	IMPEDANCE ($\Omega \pm 25\%$)	Test frequency	DCR (Ω) Max	Rated Current (mA) Max
CB321611T-700□	70	100 MHZ,200 mV	0.1	500
CB321611T-750□	75	100 MHZ,200 mV	0.15	500
CB321611T-800□	80	100 MHZ,200 mV	0.15	500
CB321611T-900□	90	100 MHZ,200 mV	0.15	500
CB321611T-101□	100	100 MHZ,200 mV	0.15	500
CB321611T-121□	120	100 MHZ,200 mV	0.15	500
CB321611T-151□	150	100 MHZ,200 mV	0.15	500
CB321611T-181□	180	100 MHZ,200 mV	0.2	400
CB321611T-201□	200	100 MHZ,200 mV	0.2	400
CB321611T-221□	220	100 MHZ,200 mV	0.2	400
CB321611T-241□	240	100 MHZ,200 mV	0.2	400
CB321611T-301□	300	100 MHZ,200 mV	0.2	400
CB321611T-401□	400	100 MHZ,200 mV	0.2	400
CB321611T-471□	470	100 MHZ,200 mV	0.2	400
CB321611T-501□	500	100 MHZ,200 mV	0.2	400
CB321611T-601□	600	100 MHZ,200 mV	0.3	400
CB321611T-701□	700	100 MHZ,200 mV	0.4	200
CB321611T-102□	1000	50 MHZ,200 mV	0.4	200
CB321611T-122□	1200	50 MHZ,200 mV	0.4	200
CB321611T-152□	1500	50 MHZ,200 mV	0.45	200
CB321611T-202□	2000	30 MHZ,200 mV	0.6	200

Multilayer Chip Beads / CB TYPE**Electrical Characteristics (CB451616 TYPE)**

Part No.	IMPEDANCE ($\Omega \pm 25\%$)	Test frequency	DCR (Ω) Max	Rated Current (mA) Max
CB451616T-500□	50	100 MHz, 200 mV	0.2	600
CB451616T-600□	60	100 MHz, 200 mV	0.2	600
CB451616T-800□	80	100 MHz, 200 mV	0.2	600
CB451616T-900□	90	100 MHz, 200 mV	0.3	500
CB451616T-101□	100	100 MHz, 200 mV	0.3	500

NOTE:

1. Operating temperature range $-55^{\circ}\text{C} \sim 125^{\circ}\text{C}$
2. Rate Current : Applied the current to coils, the temperature rise shall not be more than 30°C
3. □Tolerance : J=5% ; K=10% ; M=20% ; Y=25% ; N=30%

Multilayer Chip Beads / CB TYPE

4. Reliability and Test Conditions(可靠性測試條件)

1-1.Mechanical Performance

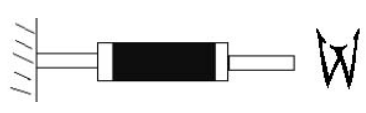
Item	Specification	Test Method
Flexure Strength	The forces applied on the right conditions must not damage the terminal electrode and the ferrite	Test device shall be soldered on the substrate Substrate Dimension: 100x40x1.6mm Deflection: 2.0mm Keeping Time: 30sec *For 100505, substrate dimension is 100x40x0.8mm
Vibration		Test device shall be soldered on the substrate Oscillation Frequency: 10 to 55 to 10Hz for 1min Amplitude: 1.5mm Time: 2hrs for each axis (X, Y & Z), total 6hrs
Resistance to Soldering Heat	Appearance: No damage More than 75% of the terminal electrode should be covered with solder. Impedance : within $\pm 30\%$ of initial value	Pre-heating: 150°C, 1min Solder Composition: Sn/Pb = 63/37 Solder Composition: Sn/Ag3.0/Cu0.5(Pb-Free) Solder Temperature: 260 ± 5 °C Immersion Time: 10 ± 1 sec
Solder ability	The electrodes shall be at least 90% covered with new solder coating	Pre-heating: 150°C, 1min Solder Composition: Sn/Pb = 63/37 Solder Temperature: 220 ± 5 °C Solder Composition: Sn/Ag3.0/Cu0.5(Pb-Free) Solder Temperature: 245 ± 5 °C (Pb-Free) Immersion Time: 4 ± 1 sec
Terminal Strength Test	100505 series : ≥ 0.2 kg 160808 series : ≥ 0.5 kg 201209 series : ≥ 1.0 kg other series : ≥ 2.0 kg BAY/BAQ321609 series: ≥ 1.5 kg (Push)	Test device shall be soldered on the substrate 

Item	Specification	Test Method															
Temperature Cycle	Appearance: No damage Impedance: within $\pm 30\%$ of initial value	One cycle: <table border="1"> <thead> <tr> <th>Step</th> <th>Temperature (°C)</th> <th>Time (min)</th> </tr> </thead> <tbody> <tr> <td>1</td> <td>-55± 3</td> <td>30</td> </tr> <tr> <td>2</td> <td>25± 2</td> <td>3</td> </tr> <tr> <td>3</td> <td>125± 3</td> <td>30</td> </tr> <tr> <td>4</td> <td>25± 2</td> <td>3</td> </tr> </tbody> </table>	Step	Temperature (°C)	Time (min)	1	-55 ± 3	30	2	25 ± 2	3	3	125 ± 3	30	4	25 ± 2	3
Step		Temperature (°C)	Time (min)														
1		-55 ± 3	30														
2		25 ± 2	3														
3	125 ± 3	30															
4	25 ± 2	3															
Humidity Resistance	Total: 100cycles Measured after exposure in the room condition for 24hrs Temperature: 40 ± 2 °C Relative Humidity: 90 ~ 95% / Time: 1000hrs Measured after exposure in the room condition for 24hrs																
High Temperature Resistance	Temperature: 125 ± 3 °C / Relative Humidity: 0% Applied Current: Rated Current /Time: 1000hrs Measured after exposure in the room condition for 24hrs																
Low Temperature Resistance	Temperature: -55 ± 3 °C Relative Humidity: 0% / Time: 1000hrs Measured after exposure in the room condition for 24hrs																

Multilayer Chip Beads / CB TYPE

4 .Packing Specifications

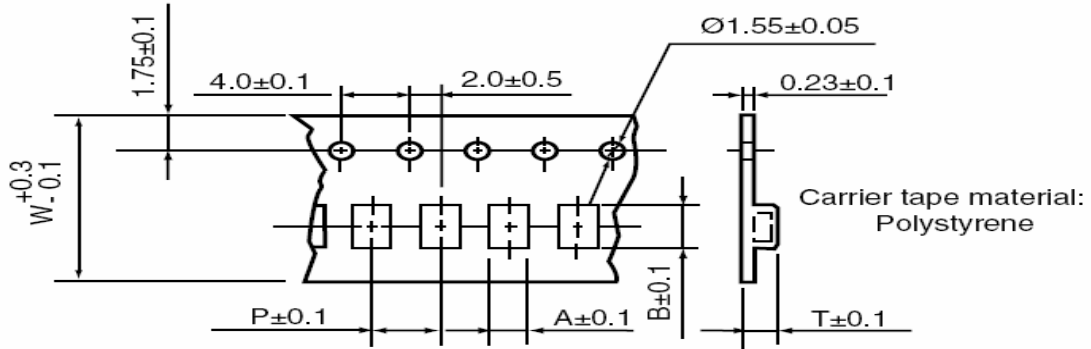

TYPE	Packaging Quantity		Tape Dimension				
	Pcs / Reel	Inner box	A	B	W	P	T
CB100505	10000	50000	1.08	1.88	8	4	1.05
CB160808	4000	20000	1.42	2.24	8	4	1.04
CB201209	4000	20000	1.88	3.5	8	4	1.27
CB321611	3000	15000	1.93	4.95	12	4	1.93
CB451616	2000	10000	3.66	4.95	12	8	1.83

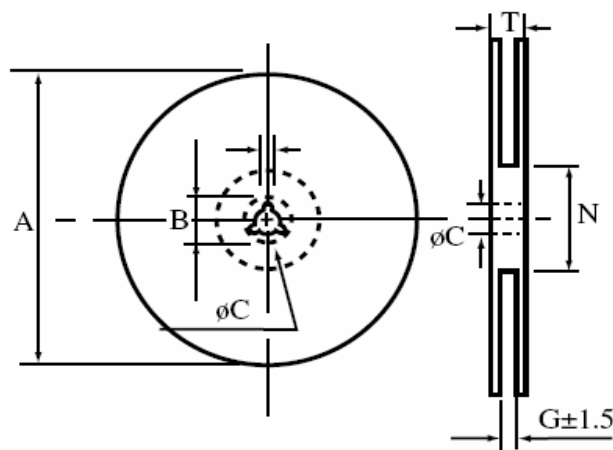

TYPE	Reel Dimension					
	A	B	C	G	N	T
8mm	178±2	21.0±0.8	13.0±0.8	10	75	12.5
12mm	178±2	21.0±0.8	13.0±0.8	14	75	16.5

High Frequency Chip Inductor / CF TYPE

.Features:

- 1.Closed magnetic circuit avoids crosstalk.
- 2.S.M.T. type.
- 3.Excellent solderability and heat resistance.
- 4.High reliability.
- 5.The products contain no lead and also support lead-free soldering.
- 6.Supports operating frequency up to 6GHz with nominal inductance values from 1.0nH to 470nH.

.Applications:

- 1.Prevention of electromagnetic interference to signals on the secondary side of electric equipment.
- 2.RF module of telecommunication products, personal handyphone systems, pagers, cellular phones, computer communications, etc...

.Product Identification :

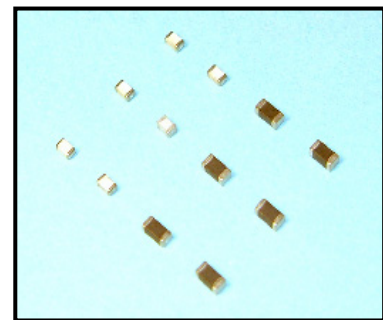
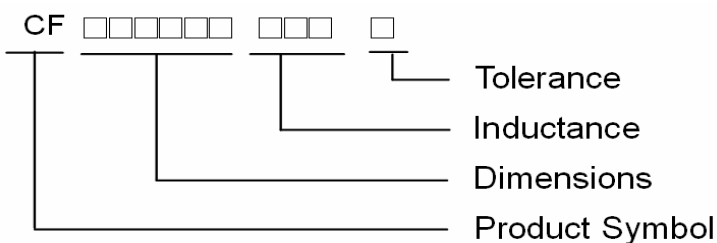

.Shape and Dimension

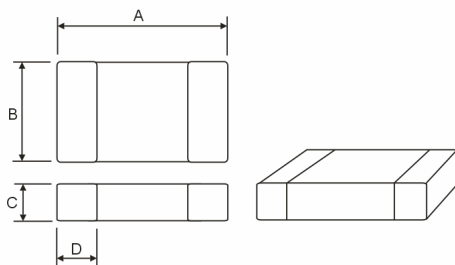

.Schematic

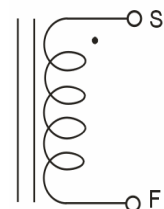

Dimensions in mm

TYPE	A(mm)	B(mm)	C(mm)	D(mm)
CF100505	1.0±0.1	0.5±0.1	0.5±0.1	0.25±0.1
CF160808	1.6±0.15	0.8±0.15	0.8±0.15	0.3±0.2
CF201209	2.0±0.2	1.25±0.2	0.9±0.2	0.5±0.3
CF201212	2.0±0.2	1.25±0.2	1.2±0.3	0.5±0.3

.Recommended Reflow

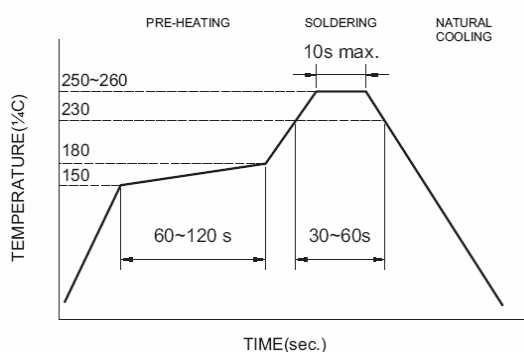

High Frequency Chip Inductor / CF TYPE

Electrical Characteristics (CF100505 TYPE)

Part No.	Inductance (nH)	Tolerance (±)	L,Q Test Freq. (MHz)	Q Min	SRF (MHz)Typ.	DCR (Ω) Max	Rated Current (mA) Max
CF100505T-0N2□	0.2	0.3nH	100 MHz,200 mV	8	10000	0.1	400
CF100505T-0N3□	0.3	0.3nH	100 MHz,200 mV	8	10000	0.1	400
CF100505T-0N4□	0.4	0.3nH	100 MHz,200 mV	8	10000	0.1	400
CF100505T-0N5□	0.5	0.3nH	100 MHz,200 mV	8	10000	0.1	400
CF100505T-0N6□	0.6	0.3nH	100 MHz,200 mV	8	10000	0.1	400
CF100505T-0N7□	0.7	0.3nH	100 MHz,200 mV	8	10000	0.1	400
CF100505T-0N8□	0.8	0.3nH	100 MHz,200 mV	8	10000	0.1	400
CF100505T-1N0□	1	0.3nH	100 MHz,200 mV	8	10000	0.1	400
CF100505T-1N2□	1.2	0.3nH	100 MHz,200 mV	8	10000	0.1	400
CF100505T-1N3□	1.3	0.3nH	100 MHz,200 mV	8	9000	0.1	400
CF100505T-1N5□	1.5	0.3nH	100 MHz,200 mV	8	9000	0.1	400
CF100505T-1N8□	1.8	0.3nH	100 MHz,200 mV	8	8700	0.1	400
CF100505T-2N0□	2	0.3nH	100 MHz,200 mV	8	8100	0.15	400
CF100505T-2N2□	2.2	0.3nH	100 MHz,200 mV	8	8100	0.15	400
CF100505T-2N4□	2.4	0.3nH	100 MHz,200 mV	8	7700	0.15	400
CF100505T-2N7□	2.7	0.3nH	100 MHz,200 mV	8	7700	0.15	400
CF100505T-3N0□	3	0.3nH	100 MHz,200 mV	8	6300	0.15	400
CF100505T-3N3□	3.3	0.3nH,10%	100 MHz,200 mV	8	6300	0.15	400
CF100505T-3N6□	3.6	0.3nH,10%	100 MHz,200 mV	8	6100	0.15	400
CF100505T-3N9□	3.9	0.3nH,10%	100 MHz,200 mV	8	6100	0.2	400
CF100505T-4N3□	4.3	0.3nH,10%	100 MHz,200 mV	8	5400	0.2	400
CF100505T-4N7□	4.7	0.3nH,10%	100 MHz,200 mV	8	5400	0.2	400
CF100505T-5N0□	5	0.3nH,10%	100 MHz,200 mV	8	5100	0.2	400
CF100505T-5N1□	5.1	0.3nH,10%	100 MHz,200 mV	8	5100	0.2	400
CF100505T-5N6□	5.6	0.3nH,10%	100 MHz,200 mV	8	5100	0.2	400
CF100505T-6N0□	6	0.3nH,10%	100 MHz,200 mV	8	4550	0.25	400
CF100505T-6N2□	6.2	5%,10%	100 MHz,200 mV	8	4550	0.25	400
CF100505T-6N8□	6.8	5%,10%	100 MHz,200 mV	8	4550	0.25	400
CF100505T-7N5□	7.5	5%,10%	100 MHz,200 mV	8	4300	0.25	400
CF100505T-8N0□	8	5%,10%	100 MHz,200 mV	8	4100	0.3	300
CF100505T-8N2□	8.2	5%,10%	100 MHz,200 mV	8	4100	0.3	300
CF100505T-9N1□	9.1	5%,10%	100 MHz,200 mV	8	3900	0.35	300
CF100505T-10N□	10	5%,10%	100 MHz,200 mV	8	3900	0.35	300
CF100505T-12N□	12	5%,10%	100 MHz,200 mV	8	3000	0.4	300
CF100505T-15N□	15	5%,10%	100 MHz,200 mV	8	2600	0.5	300
CF100505T-18N□	18	5%,10%	100 MHz,200 mV	8	2350	0.55	300
CF100505T-22N□	22	5%,10%	100 MHz,200 mV	8	2000	0.7	300
CF100505T-27N□	27	5%,10%	100 MHz,200 mV	8	1900	0.8	300
CF100505T-33N□	33	5%,10%	100 MHz,200 mV	8	1700	1	200

High Frequency Chip Inductor / CF TYPE

Electrical Characteristics (CF100505 TYPE)

Part No.	Inductance (nH)	Tolerance (±)	L,Q Test Freq. (MHz)	Q Min	SRF (MHz)Typ.	DCR (Ω) Max	Rated Current (mA) Max
CF100505T-39N□	39	5%,10%	100 MHz,200 mV	8	1600	1.2	150
CF100505T-47N□	47	5%,10%	100 MHz,200 mV	8	1300	1.3	150
CF100505T-56N□	56	5%,10%	100 MHz,200 mV	8	1250	2	150
CF100505T-68N□	68	5%,10%	100 MHz,200 mV	8	1000	2.2	100
CF100505T-82N□	82	5%,10%	100 MHz,200 mV	8	900	2.5	100
CF100505T-R10□	100	5%,10%	100 MHz,200 mV	8	850	2.5	100

Electrical Characteristics (CF160808 TYPE)

Part No.	Inductance (nH)	Tolerance (±)	L,Q Test Freq. (MHz)	Q Min	SRF (MHz)Typ.	DCR (Ω) Max	Rated Current (mA) Max
CF160808T-1N0□	1	0.3nH	100 MHz,200 mV	8	10000	0.1	600
CF160808T-1N2□	1.2	0.3nH	100 MHz,200 mV	8	10000	0.1	600
CF160808T-1N5□	1.5	0.3nH	100 MHz,200 mV	8	8000	0.1	600
CF160808T-1N6□	1.6	0.2nH,0.3nH	100 MHz,200 mV	8	8000	0.1	600
CF160808T-1N7□	1.7	0.2nH,0.3nH	100 MHz,200 mV	8	8000	0.1	600
CF160808T-1N8□	1.8	0.3nH	100 MHz,200 mV	8	8000	0.1	600
CF160808T-2N2□	2.2	0.3nH	100 MHz,200 mV	8	7200	0.1	600
CF160808T-2N5□	2.5	0.2nH,0.3nH	100 MHz,200 mV	8	6200	0.1	600
CF160808T-2N7□	2.7	0.3nH	100 MHz,200 mV	10	6200	0.1	600
CF160808T-3N3□	3.3	0.3nH,10%	100 MHz,200 mV	10	5200	0.12	600
CF160808T-3N9□	3.9	0.3nH,10%	100 MHz,200 mV	10	5000	0.14	600
CF160808T-4N3□	4.3	0.3nH,10%	100 MHz,200 mV	10	4750	0.16	600
CF160808T-4N7□	4.7	0.3nH,10%	100 MHz,200 mV	10	4750	0.16	600
CF160808T-5N1□	5.1	0.3nH,10%	100 MHz,200 mV	10	4100	0.18	600
CF160808T-5N4□	5.4	0.2nH,0.3nH	100 MHz,200 mV	8	4100	0.18	600
CF160808T-5N6□	5.6	0.3nH,10%	100 MHz,200 mV	10	4100	0.18	600
CF160808T-6N2□	6.2	5%,10%	100 MHz,200 mV	10	3750	0.22	600
CF160808T-6N8□	6.8	5%,10%	100 MHz,200 mV	10	3750	0.22	600
CF160808T-7N5□	7.5	5%,10%	100 MHz,200 mV	10	3300	0.24	600
CF160808T-8N2□	8.2	5%,10%	100 MHz,200 mV	10	3300	0.24	600
CF160808T-10N□	10	5%,10%	100 MHz,200 mV	12	3000	0.26	600
CF160808T-11N5□	11.5	5%,10%	100 MHz,200 mV	8	2800	0.3	1000
CF160808T-12N□	12	5%,10%	100 MHz,200 mV	12	2600	0.28	600
CF160808T-15N□	15	5%,10%	100 MHz,200 mV	12	2500	0.32	600
CF160808T-18N□	18	5%,10%	100 MHz,200 mV	12	2400	0.35	600
CF160808T-22N□	22	5%,10%	100 MHz,200 mV	12	2000	0.4	500
CF160808T-27N□	27	5%,10%	100 MHz,200 mV	12	1900	0.45	500
CF160808T-33N□	33	5%,10%	100 MHz,200 mV	12	1600	0.55	400
CF160808T-39N□	39	5%,10%	100 MHz,200 mV	12	1400	0.6	400
CF160808T-47N□	47	5%,10%	100 MHz,200 mV	12	1300	0.7	400
CF160808T-56N□	56	5%,10%	100 MHz,200 mV	12	1100	0.75	400

High Frequency Chip Inductor / CF TYPE

Electrical Characteristics (CF16080808 TYPE)

Part No.	Inductance (nH)	Tolerance (±)	L,Q Test Freq. (MHz)	Q Min	SRF (MHz)Typ.	DCR (Ω) Max	Rated Current (mA) Max
CF160808T-62N□	62	5%,10%	100 MHz,200 mV	12	1050	0.85	400
CF160808T-68N□	68	5%,10%	100 MHz,200 mV	12	1050	0.85	400
CF160808T-75N□	75	5%,10%	100 MHz,200 mV	12	900	1	300
CF160808T-82N□	82	5%,10%	100 MHz,200 mV	12	900	1	300
CF160808T-R10□	100	5%,10%	100 MHz,200 mV	12	770	1.2	300
CF160808T-R12□	120	5%,10%	50 MHz,200 mV	8	850	2.3	300
CF160808T-R15□	150	5%,10%	50 MHz,200 mV	8	550	2.4	250
CF160808T-R18□	180	5%,10%	50 MHz,200 mV	8	520	2.7	250
CF160808T-R22□	220	5%,10%	50 MHz,200 mV	8	500	3	250

Electrical Characteristics (CF201209 TYPE)

Part No.	Inductance (nH)	Tolerance (±)	L,Q Test Freq. (MHz)	Q Min	SRF (MHz)Typ.	DCR (Ω) Max	Rated Current (mA) Max
CF201209T-1N0□	1	0.3nH	100 MHz,200 mV	10	>6000	0.1	300
CF201209T-1N2□	1.2	0.3nH	100 MHz,200 mV	10	>6000	0.1	300
CF201209T-1N5□	1.5	0.3nH	100 MHz,200 mV	10	>6000	0.1	300
CF201209T-1N8□	1.8	0.3nH	100 MHz,200 mV	10	>6000	0.1	300
CF201209T-2N2□	2.2	0.3nH	100 MHz,200 mV	10	>6000	0.1	300
CF201209T-2N7□	2.7	0.3nH	100 MHz,200 mV	12	>6000	0.1	300
CF201209T-3N3□	3.3	0.3nH,10%	100 MHz,200 mV	12	>6000	0.13	300
CF201209T-3N9□	3.9	0.3nH,10%	100 MHz,200 mV	12	5400	0.15	300
CF201209T-4N7□	4.7	0.3nH,10%	100 MHz,200 mV	12	4500	0.2	300
CF201209T-5N6□	5.6	0.3nH,5,10%	100 MHz,200 mV	12	4000	0.23	300
CF201209T-6N8□	6.8	0.3nH,10%	100 MHz,200 mV	15	3650	0.25	300
CF201209T-8N2□	8.2	0.3nH,10%	100 MHz,200 mV	15	3000	0.28	300
CF201209T-10N□	10	5%,10%	100 MHz,200 mV	15	2500	0.3	300
CF201209T-12N□	12	5%,10%	100 MHz,200 mV	15	2450	0.35	300
CF201209T-15N□	15	5%,10%	100 MHz,200 mV	15	2000	0.4	300
CF201209T-18N□	18	5%,10%	100 MHz,200 mV	15	1750	0.45	300
CF201209T-22N□	22	5%,10%	100 MHz,200 mV	15	1700	0.5	300
CF201209T-27N□	27	5%,10%	100 MHz,200 mV	15	1550	0.55	300
CF201209T-33N□	33	5%,10%	100 MHz,200 mV	15	1350	0.6	300
CF201209T-39N□	39	5%,10%	100 MHz,200 mV	18	1300	0.65	300
CF201209T-47N□	47	5%,10%	100 MHz,200 mV	18	1200	0.7	300
CF201209T-56N□	56	5%,10%	100 MHz,200 mV	18	1150	0.75	300
CF201209T-68N□	68	5%,10%	100 MHz,200 mV	18	1000	0.8	300
CF201209T-82N□	82	5%,10%	100 MHz,200 mV	18	850	0.9	300
CF201209T-R10□	100	5%,10%	100 MHz,200 mV	18	730	1	300
CF201209T-R12□	120	5%,10%	50 MHz,200 mV	13	650	1.2	300
CF201209T-R15□	150	5%,10%	50 MHz,200 mV	13	550	1.4	300
CF201209T-R18□	180	5%,10%	50 MHz,200 mV	13	500	1.8	300

High Frequency Chip Inductor / CF TYPE

Electrical Characteristics (CF201209 TYPE)

Part No.	Inductance (nH)	Tolerance (±%)	L,Q Test Freq. (MHz)	Q Min	SRF (MHz)Typ.	DCR (Ω) Max	Rated Current (mA) Max
CF201209T-R22□	220	5%,10%	50 MHz,200 mV	12	450	2	300
CF201209T-R27□	270	5%,10%	50 MHz,200 mV	12	400	2.5	200
CF201209T-R33□	330	5%,10%	50 MHz,200 mV	12	380	3	200

Electrical Characteristics (CF201212 TYPE)

Part No.	Inductance (nH)	Tolerance (±)	L,Q Test Freq. (MHz)	Q Min	SRF (MHz)Typ.	DCR (Ω) Max	Rated Current (mA) Max
CF201212T-R39□	390	5%,10%	50 MHz,200 mV	10	330	3.5	200
CF201212T-R47□	470	5%,10%	50 MHz,200 mV	10	300	4	200

NOTE:

1. Operating temperature range $-55^{\circ}\text{C} \sim 125^{\circ}\text{C}$
2. Rate Current : Applied the current to coils, the temperature rise shall not be more than 30°C
3. □Tolerance : C= $\pm 0.2\text{nH}$; S= $\pm 0.3\text{nH}$; J= $\pm 5\%$; K= $\pm 10\%$

High Frequency Chip Inductor / CF TYPE

4. Reliability and Test Conditions(可靠性測試條件)

1-1.Mechanical Performance

Item	Specification	Test Method															
Flexure Strength	The forces applied on the right conditions must not damage the terminal electrode and the ferrite	Test device shall be soldered on the substrate Substrate Dimension: 100x40x1.6mm Deflection: 2.0mm Keeping Time: 30sec *For 100505, substrate dimension is 100x40x0.8mm															
Vibration		Test device shall be soldered on the substrate Oscillation Frequency: 10 to 55 to 10Hz for 1min Amplitude: 1.5mm Time: 2hrs for each axis (X, Y & Z), total 6hrs															
Resistance to Soldering Heat	Appearance: No damage	Pre-heating: 150°C, 1min Solder Composition: Sn/Pb = 63/37 Solder Composition: Sn/Ag3.0/Cu0.5(Pb-Free) Solder Temperature: 260±5°C Immersion Time: 10±1sec															
Solder ability	The electrodes shall be at least 90% covered with new solder coating	Pre-heating: 150°C, 1min Solder Composition: Sn/Pb = 63/37 Solder Temperature: 220±5°C Solder Composition: Sn/Ag3.0/Cu0.5(Pb-Free) Solder Temperature: 245±5°C (Pb-Free) Immersion Time: 4±1sec															
Temperature Cycle	Appearance: No damage Inductance: within±10% of initial value Q change: within±30% of initial value	One cycle: <table border="1" style="width: 100%; border-collapse: collapse; text-align: center;"> <thead> <tr> <th>Step</th> <th>Temperature (°C)</th> <th>Time (min)</th> </tr> </thead> <tbody> <tr> <td>1</td> <td>-55±3</td> <td>30</td> </tr> <tr> <td>2</td> <td>25±2</td> <td>3</td> </tr> <tr> <td>3</td> <td>125±3</td> <td>30</td> </tr> <tr> <td>4</td> <td>25±2</td> <td>3</td> </tr> </tbody> </table> Total: 100cycles Measured after exposure in the room condition for 24hrs	Step	Temperature (°C)	Time (min)	1	-55±3	30	2	25±2	3	3	125±3	30	4	25±2	3
Step		Temperature (°C)	Time (min)														
1		-55±3	30														
2		25±2	3														
3		125±3	30														
4	25±2	3															
Humidity Resistance	Temperature: 40±2°C Relative Humidity: 90 ~ 95% / Time: 1000hrs Measured after exposure in the room condition for 24hrs																
High Temperature Resistance	Temperature: 125±3°C Relative Humidity: 20% Applied Current: Rated Current / Time: 1000hrs Measured after exposure in the room condition for 24hrs																
Low Temperature Resistance	Temperature: -55±3°C Relative Humidity: 0% / Time: 1000hrs Measured after exposure in the room condition for 24hrs																

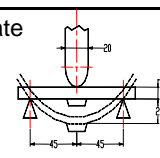

High Frequency Chip Inductor / CF TYPE

4 .Packing Specifications

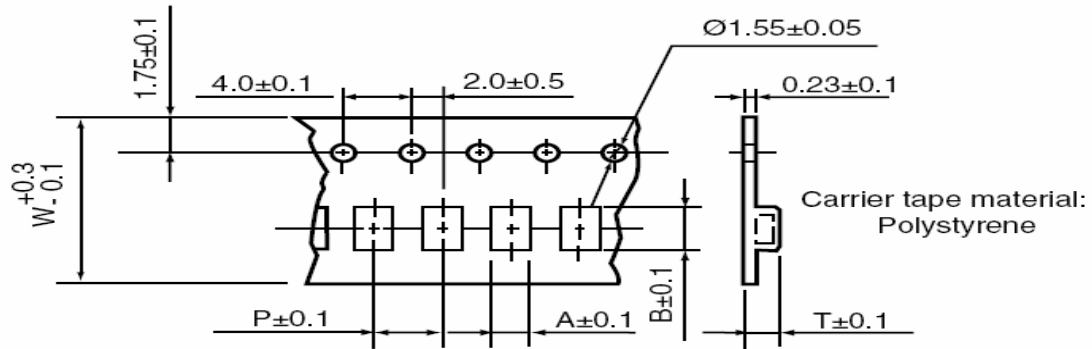

TYPE	Packaging Quantity		Tape Dimension				
	Pcs / Reel	Inner box	A	B	W	P	T
CF100505	10000	50000	0.65	1.12	8	2	0.60
CF160808	4000	20000	1.00	1.80	8	4	0.95
CF201209	4000	20000	1.58	2.42	8	4	0.95
CF201212	3000	15000	1.35	2.25	8	4	0.22

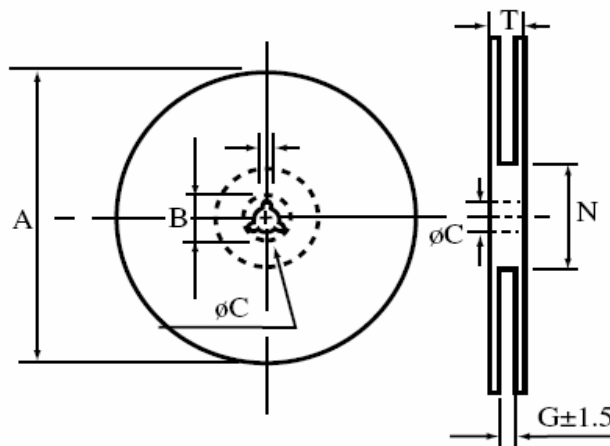

TYPE	Reel Dimension					
	A	B	C	G	N	T
8mm	178±2	21.0±0.8	13.0±0.8	10	75	12.5
12mm	178±2	21.0±0.8	13.0±0.8	14	75	16.5

Multilayer Chip Inductor / CL TYPE

.Features:

- 1.Closed magnetic circuit avoids crosstalk.
- 2.S.M.T. type.
- 3.Excellent solderability and heat resistance.
- 4.High reliability.
- 5.The products contain no lead and also support lead-free soldering.

.Applications:

For main board, CD-ROM, hard disk driver, digital TVs and VTRs Printers, wireless phone, personal computers and general consumer and computers products.

.Product Identification :

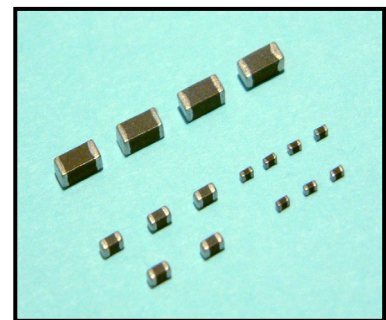
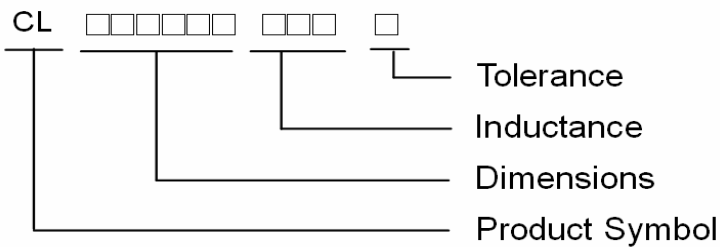

.Shape and Dimension

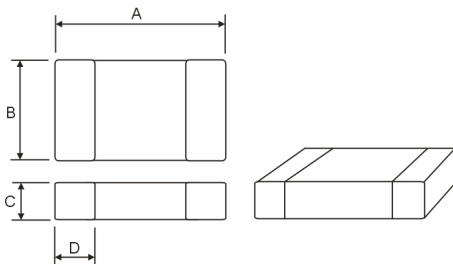

.Schematic

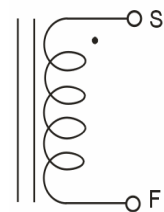

Dimensions in mm

TYPE	A(mm)	B(mm)	C(mm)	D(mm)
CL160808	1.6±0.2	0.8±0.2	0.8±0.2	0.3±0.2
CL201209	2.0±0.2	1.25±0.2	0.9±0.2	0.5±0.3
CL201212	2.0±0.2	1.25±0.2	1.25±0.2	0.5±0.3
CL321611	3.2±0.2	1.6±0.2	1.1±0.2	0.5±0.3

.Recommended Reflow

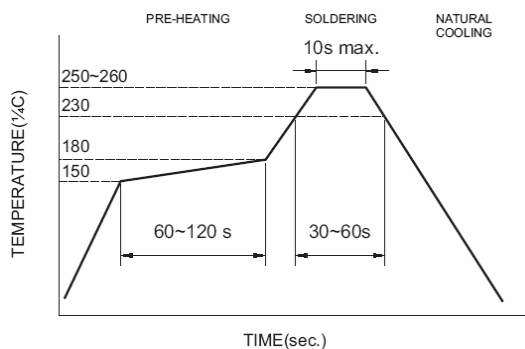

Multilayer Chip Inductor / CL TYPE

. Electrical Characteristics (CL160808 TYPE)

Part No.	Inductance (μ H)	Tolerance (\pm %)	L, Q Test Freq. (MHz)	Q Min	SRF (MHz)Min.	DCR (Ω) Max	Rated Current (mA) Max
CL160808T-10N□	0.01	20	50 MHz, 200 mV	15	300	0.20	50
CL160808T-33N□	0.033	20	50 MHz, 200 mV	15	270	0.20	50
CL160808T-47N□	0.047	20	50 MHz, 200 mV	15	260	0.30	50
CL160808T-56N□	0.056	20	50 MHz, 200 mV	15	255	0.30	50
CL160808T-68N□	0.068	20	50 MHz, 200 mV	15	250	0.30	50
CL160808T-82N□	0.082	20	50 MHz, 200 mV	15	245	0.30	50
CL160808T-R10□	0.1	10, 20	25 MHz, 200 mV	25	240	0.50	50
CL160808T-R12□	0.12	10, 20	25 MHz, 200 mV	25	205	0.50	50
CL160808T-R15□	0.15	10, 20	25 MHz, 200 mV	25	180	0.60	50
CL160808T-R18□	0.18	10, 20	25 MHz, 200 mV	25	165	0.60	50
CL160808T-R22□	0.22	10, 20	25 MHz, 200 mV	25	150	0.80	50
CL160808T-R27□	0.27	10, 20	25 MHz, 200 mV	25	136	0.80	50
CL160808T-R33□	0.33	10, 20	25 MHz, 200 mV	25	125	0.85	35
CL160808T-R39□	0.39	10, 20	25 MHz, 200 mV	25	110	1.00	35
CL160808T-R47□	0.47	10, 20	25 MHz, 200 mV	25	105	1.35	35
CL160808T-R56□	0.56	10, 20	25 MHz, 200 mV	25	95	1.50	35
CL160808T-R68□	0.68	10, 20	25 MHz, 200 mV	25	85	1.70	35
CL160808T-R82□	0.82	10, 20	25 MHz, 200 mV	25	75	2.10	35
CL160808T-1R0□	1	10, 20	10 MHz, 200 mV	35	65	0.60	25
CL160808T-1R2□	1.2	10, 20	10 MHz, 200 mV	35	60	0.80	25
CL160808T-1R5□	1.5	10, 20	10 MHz, 200 mV	35	55	0.80	25
CL160808T-1R8□	1.8	10, 20	10 MHz, 200 mV	35	50	0.95	25
CL160808T-2R2□	2.2	10, 20	10 MHz, 200 mV	35	45	1.10	15
CL160808T-2R7□	2.7	10, 20	10 MHz, 200 mV	35	40	1.30	15
CL160808T-3R3□	3.3	10, 20	10 MHz, 200 mV	35	38	1.50	15
CL160808T-3R9□	3.9	10, 20	10 MHz, 200 mV	35	36	1.7	15
CL160808T-4R7□	4.7	10, 20	4 MHz, 200 mV	35	33	2.1	15
CL160808T-5R6□	5.6	10, 20	4 MHz, 200 mV	35	22	1.5	5
CL160808T-6R8□	6.8	10, 20	4 MHz, 60 mV	35	20	1.7	5
CL160808T-8R2□	8.2	10, 20	2 MHz, 60 mV	30	18	2.1	5
CL160808T-100□	10	10, 20	2 MHz, 60 mV	30	17	2.55	5
CL160808T-120□	12	10, 20	1 MHz, 60 mV	30	15	2.6	3

Electrical Characteristics (CL201209 TYPE)

Part No.	Inductance (μ H)	Tolerance (\pm %)	L, Q Test Freq. (MHz)	Q Min	SRF (MHz)Min.	DCR (Ω) Max	Rated Current (mA) Max
CL201209T-22N□	0.022	20	50 MHz, 200 mV	20	320	0.20	300
CL201209T-33N□	0.033	20	50 MHz, 200 mV	20	320	0.20	300
CL201209T-47N□	0.047	20	50 MHz, 200 mV	20	320	0.20	300
CL201209T-56N□	0.056	20	50 MHz, 200 mV	20	320	0.20	300

Multilayer Chip Inductor / CL TYPE

Electrical Characteristics (CL201209 TYPE)

Part No.	Inductance (μ H)	Tolerance (\pm %)	L,Q Test Freq. (MHz)	Q Min	SRF (MHz)Min.	DCR (Ω) Max	Rated Current (mA) Max
CL201209T-68N□	0.068	20	50 MHz,200 mV	20	280	0.20	300
CL201209T-82N□	0.082	20	50 MHz,200 mV	20	255	0.20	300
CL201209T-R10□	0.1	10, 20	25 MHz,200 mV	25	235	0.30	250
CL201209T-R12□	0.12	10, 20	25 MHz,200 mV	25	220	0.30	250
CL201209T-R15□	0.15	10, 20	25 MHz,200 mV	25	200	0.40	250
CL201209T-R18□	0.18	10, 20	25 MHz,200 mV	25	185	0.40	250
CL201209T-R22□	0.22	10, 20	25 MHz,200 mV	25	170	0.50	250
CL201209T-R27□	0.27	10, 20	25 MHz,200 mV	25	150	0.50	250
CL201209T-R33□	0.33	10, 20	25 MHz,200 mV	25	145	0.55	250
CL201209T-R39□	0.39	10, 20	25 MHz,200 mV	25	135	0.65	250
CL201209T-R47□	0.47	10, 20	25 MHz,200 mV	25	125	0.65	250
CL201209T-R56□	0.56	10, 20	25 MHz,200 mV	25	115	0.75	150
CL201209T-R68□	0.68	10, 20	25 MHz,200 mV	25	105	0.80	150
CL201209T-R82□	0.82	10, 20	25 MHz,200 mV	25	100	1.00	150
CL201209T-1R0□	1	10, 20	10 MHz,200 mV	45	75	0.40	50
CL201209T-1R2□	1.2	10, 20	10 MHz,200 mV	45	65	0.50	50
CL201209T-1R5□	1.5	10, 20	10 MHz,200 mV	45	60	0.50	50
CL201209T-1R8□	1.8	10, 20	10 MHz,200 mV	45	55	0.60	50
CL201209T-2R2□	2.2	10, 20	10 MHz,200 mV	45	50	0.65	30

Electrical Characteristics (CL201212 TYPE)

Part No.	Inductance (μ H)	Tolerance (\pm %)	L,Q Test Freq. (MHz)	Q Min	SRF (MHz)Min.	DCR (Ω) Max	Rated Current (mA) Max
CL201212T-2R7□	2.7	10, 20	10 MHz,200 mV	45	45	0.75	30
CL201212T-3R3□	3.3	10, 20	10 MHz,200 mV	45	41	0.80	30
CL201212T-3R9□	3.9	10, 20	10 MHz,200 mV	45	38	0.90	30
CL201212T-4R7□	4.7	10, 20	10 MHz,200 mV	45	35	1.00	30
CL201212T-5R6□	5.6	10, 20	4 MHz,200 mV	45	32	0.90	15
CL201212T-6R8□	6.8	10, 20	4 MHz,200 mV	45	29	1.00	15
CL201212T-8R2□	8.2	10, 20	4 MHz,200 mV	45	26	1.10	15
CL201212T-100□	10	10, 20	2 MHz,60 mV	45	24	1.10	15
CL201212T-120□	12	10, 20	2 MHz,60 mV	45	22	1.20	15
CL201212T-150□	15	10, 20	1 MHz,60 mV	30	19	0.80	5
CL201212T-180□	18	10, 20	1 MHz,60 mV	30	18	0.90	5
CL201212T-220□	22	10, 20	1 MHz,60 mV	30	16	1.10	5

Electrical Characteristics (CL321611 TYPE)

Part No.	Inductance (μ H)	Tolerance (\pm %)	L,Q Test Freq. (MHz)	Q Min	SRF (MHz)Min.	DCR (Ω) Max	Rated Current (mA) Max
CL321611T-47N□	0.047	20	50 MHz,200 mV	20	320	0.15	300
CL321611T-56N□	0.056	20	50 MHz,200 mV	20	280	0.25	300
CL321611T-68N□	0.068	20	50 MHz,200 mV	20	280	0.25	300

Multilayer Chip Inductor / CL TYPE

Electrical Characteristics (CL321611 TYPE)

Part No.	Inductance (μ H)	Tolerance (\pm %)	L, Q Test Freq. (MHz)	Q Min	SRF (MHz)Min.	DCR (Ω) Max	Rated Current (mA) Max
CL321611T-82N□	0.082	20	50 MHz, 200 mV	20	250	0.25	300
CL321611T-R10□	0.1	10, 20	25 MHz, 200 mV	25	235	0.25	250
CL321611T-R12□	0.12	10, 20	25 MHz, 200 mV	25	220	0.30	250
CL321611T-R15□	0.15	10, 20	25 MHz, 200 mV	25	200	0.30	250
CL321611T-R18□	0.18	10, 20	25 MHz, 200 mV	25	185	0.40	250
CL321611T-R22□	0.22	10, 20	25 MHz, 200 mV	25	170	0.40	250
CL321611T-R27□	0.27	10, 20	25 MHz, 200 mV	25	150	0.50	250
CL321611T-R33□	0.33	10, 20	25 MHz, 200 mV	25	145	0.60	250
CL321611T-R39□	0.39	10, 20	25 MHz, 200 mV	25	135	0.50	200
CL321611T-R47□	0.47	10, 20	25 MHz, 200 mV	25	125	0.60	200
CL321611T-R56□	0.56	10, 20	25 MHz, 200 mV	25	115	0.70	150
CL321611T-R68□	0.68	10, 20	25 MHz, 200 mV	25	105	0.80	150
CL321611T-R82□	0.82	10, 20	25 MHz, 200 mV	25	100	0.90	150
CL321611T-1R0□	1	10, 20	10 MHz, 200 mV	45	75	0.40	100
CL321611T-1R2□	1.2	10, 20	10 MHz, 200 mV	45	65	0.50	100
CL321611T-1R5□	1.5	10, 20	10 MHz, 200 mV	45	60	0.50	80
CL321611T-1R8□	1.8	10, 20	10 MHz, 200 mV	45	55	0.50	70
CL321611T-2R2□	2.2	10, 20	10 MHz, 200 mV	45	50	0.60	60
CL321611T-2R7□	2.7	10, 20	10 MHz, 200 mV	45	45	0.60	60
CL321611T-3R3□	3.3	10, 20	10 MHz, 200 mV	45	41	0.70	60
CL321611T-3R9□	3.9	10, 20	10 MHz, 200 mV	45	38	0.80	50
CL321611T-4R7□	4.7	10, 20	10 MHz, 200 mV	45	35	0.90	50
CL321611T-5R6□	5.6	10, 20	4 MHz, 200 mV	45	32	0.70	25
CL321611T-6R8□	6.8	10, 20	4 MHz, 200 mV	45	29	0.80	25
CL321611T-8R2□	8.2	10, 20	4 MHz, 200 mV	45	26	0.90	25
CL321611T-100□	10	10, 20	2 MHz, 60 mV	45	24	1.00	25
CL321611T-120□	12	10, 20	2 MHz, 60 mV	45	22	1.00	15

NOTE:

1. Operating temperature range $-55^{\circ}\text{C} \sim 125^{\circ}\text{C}$
2. Rated Current : Applied the current to coils, the temperature rise shall not be more than 30°C
3. □Tolerance : K=10% ; M=20%

Multilayer Chip Inductor / CL TYPE

4. Reliability and Test Conditions(可靠性測試條件)

1-1.Mechanical Performance

Item	Specification	Test Method															
Flexure Strength	The forces applied on the right conditions must not damage the terminal electrode and the ferrite	Test device shall be soldered on the substrate Substrate Dimension: 100x40x1.6mm Deflection: 2.0mm Keeping Time: 30sec *For 100505, substrate dimension is 100x40x0.8mm															
Vibration		Test device shall be soldered on the substrate Oscillation Frequency: 10 to 55 to 10Hz for 1min Amplitude: 1.5mm Time: 2hrs for each axis (X, Y & Z), total 6hrs															
Resistance to Soldering Heat	Appearance: No damage More than 75% of the terminal electrode should be covered with solder. Inductance : within $\pm 30\%$ of initial value Q: within $\pm 30\%$ of initial value Inductance: within $\pm 20\%$ of initial value(160808T over 12uH)	Pre-heating: 150°C, 1min Solder Composition: Sn/Pb = 63/37 Solder Composition: Sn/Ag3.0/Cu0.5(Pb-Free) Solder Temperature: 260 \pm 5°C Immersion Time: 10 \pm 1sec															
Solder ability	The electrodes shall be at least 90% covered with new solder coating	Pre-heating: 150°C, 1min Solder Composition: Sn/Pb = 63/37 Solder Temperature: 220 \pm 5°C Solder Composition: Sn/Ag3.0/Cu0.5(Pb-Free) Solder Temperature: 245 \pm 5°C (Pb-Free) Immersion Time: 4 \pm 1sec															
Temperature Cycle	Appearance: No damage Inductance: within $\pm 10\%$ of initial value Q change: within $\pm 30\%$ of initial value	One cycle: <table border="1" style="margin-left: 20px;"> <thead> <tr> <th>Step</th> <th>Temperature (°C)</th> <th>Time (min)</th> </tr> </thead> <tbody> <tr> <td>1</td> <td>-25\pm3</td> <td>30</td> </tr> <tr> <td>2</td> <td>25\pm2</td> <td>3</td> </tr> <tr> <td>3</td> <td>85\pm3</td> <td>30</td> </tr> <tr> <td>4</td> <td>25\pm2</td> <td>3</td> </tr> </tbody> </table> Total: 100cycles Measured after exposure in the room condition for 24hrs	Step	Temperature (°C)	Time (min)	1	-25 \pm 3	30	2	25 \pm 2	3	3	85 \pm 3	30	4	25 \pm 2	3
Step	Temperature (°C)	Time (min)															
1	-25 \pm 3	30															
2	25 \pm 2	3															
3	85 \pm 3	30															
4	25 \pm 2	3															
Humidity Resistance		Temperature: 40 \pm 2°C Relative Humidity: 90 ~ 95% / Time: 1000hrs Measured after exposure in the room condition for 24hrs															
High Temperature Resistance		Temperature: 85 \pm 3°C Relative Humidity: 20% Applied Current: Rated Current / Time: 1000hrs Measured after exposure in the room condition for 24hrs															
Low Temperature Resistance		Temperature: -25 \pm 3°C Relative Humidity: 0% / Time: 1000hrs Measured after exposure in the room condition for 24hrs															

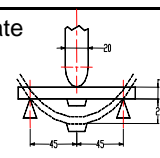

Multilayer Chip Inductor / CL TYPE

4 .Packing Specifications

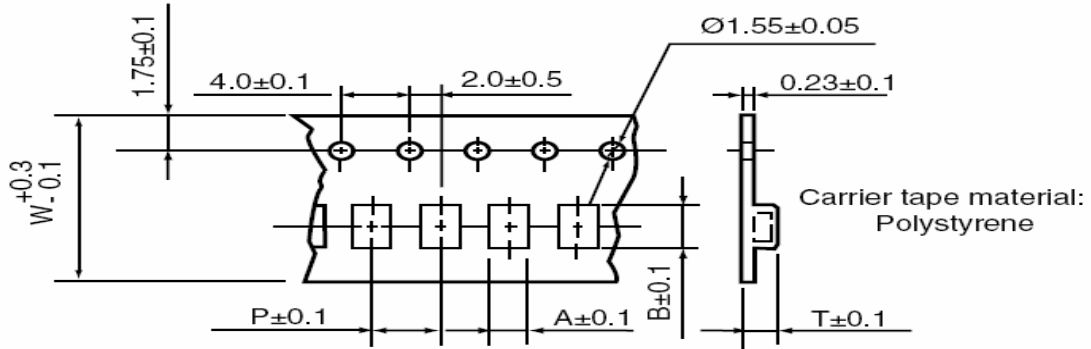

TYPE	Packaging Quantity		Tape Dimension				
	Pcs / Reel	Inner box	A	B	W	P	T
CL160808	4000	20000	1.05	1.85	8	4	0.95
CL201209	4000	20000	1.58	2.42	8	4	0.95
CL201212	3000	15000	1.35	2.25	8	4	0.22
CL321611	3000	10000	1.88	3.5	8	4	0.22

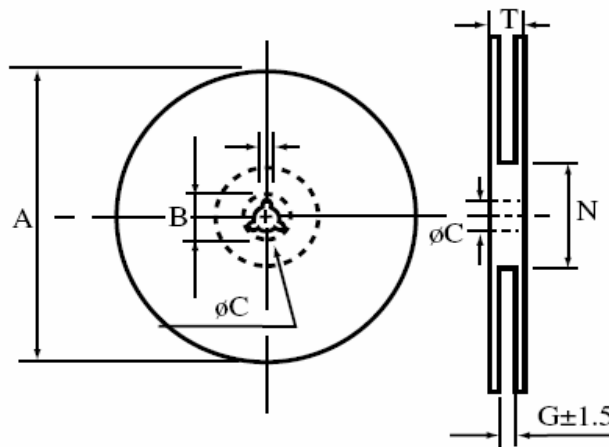

TYPE	Reel Dimension					
	A	B	C	G	N	T
8mm	178±2	21.0±0.8	13.0±0.8	10	75	12.5
12mm	178±2	21.0±0.8	13.0±0.8	14	75	16.5

WOUND CHIP INDUCTOR / NLS TYPE

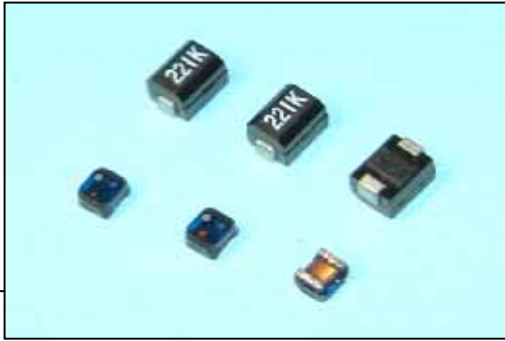

Applications :

Microtelevisions, liquid crystal televisions, video cameras, Portable VCRs, car radios, mobile telephones, radio and other electronic devices.

1. Product Identification

NLS

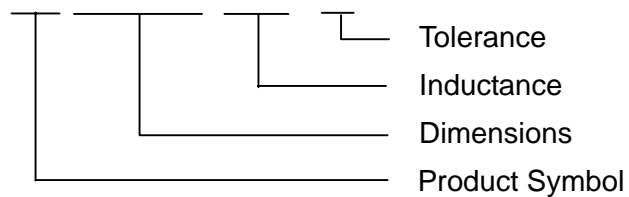

2. Shape and Dimension

NLS252018/322522 TYPE

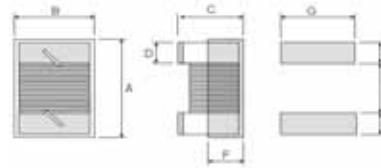

NLS453232/565050 TYPE

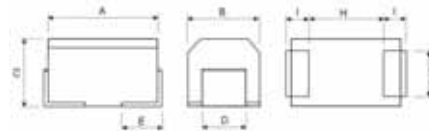

3. Dimensions in mm

Series Number	A(mm)	B(mm)	C(mm)	D(mm)	F(mm)	G(mm)	H(mm)	I(mm)
NLS252018	2.90 Max	2.79 Max	2.20 Max	0.51	0.70	2.54	1.27	1.02
NLS322522	3.70 Max	2.90 Max	2.60 Max	0.51	0.90	2.70	2.00	1.00
NLS453232	4.5±0.30	3.2±0.30	3.2±0.30	1.4±0.40	0.9±0.20	2.80	3.00	1.50
NLS565050	5.6±0.30	5.0±0.30	5.0±0.30	1.8±0.40	1.3±0.20	4.50	4.00	2.00

4. Electrical Characteristics (NLS252018 TYPE)

Part No.	INDUCTANC E (μH)	Q min	Test Frequency L,Q(MHz)	SRF (MHz) min.	DCR () Max.	Idc (mA) Max.
NLS252018-1R0□	1.0	25	7.96/7.96	300	0.34	1400
NLS252018-1R5□	1.5	25	7.96/7.96	270	0.42	1300
NLS252018-2R2□	2.2	25	7.96/7.96	140	0.50	1300
NLS252018-3R3□	3.3	25	7.96/7.96	95	0.65	800
NLS252018-4R7□	4.7	25	7.96/7.96	90	0.80	800
NLS252018-6R8□	6.8	25	7.96/7.96	68	1.00	650
NLS252018-100□	10	20	2.52/2.52	45	1.50	600
NLS252018-150□	15	20	2.52/2.52	40	2.20	450
NLS252018-220□	22	20	2.52/2.52	25	2.70	380
NLS252018-330□	33	20	2.52/2.52	25	4.00	350
NLS252018-470□	47	16	2.52/2.52	20	8.00	300

Electrical Characteristics (NLS322522 TYPE)

Part No.	INDUCTANC E (μ H)	Q min	Test Frequency L,Q(MHz)	SRF (MHz) min.	DCR () Max.	Idc (mA) Max.
NLS322522-1R0□	1.0	20	7.96/7.96	100	0.08	1500
NLS322522-1R5□	1.5	20	7.96/7.96	80	0.13	1125
NLS322522-2R2□	2.2	20	7.96/7.96	68	0.13	970
NLS322522-3R3□	3.3	20	7.96/7.96	54	0.16	837
NLS322522-4R7□	4.7	20	7.96/7.96	43	0.20	675
NLS322522-6R8□	6.8	20	7.96/7.96	33	0.27	600
NLS322522-100□	10	15	2.52/2.52	28	0.36	520
NLS322522-150□	15	15	2.52/2.52	19	0.56	480
NLS322522-220□	22	15	2.52/2.52	16	0.77	310
NLS322522-330□	33	15	2.52/2.52	12	1.10	270
NLS322522-470□	47	15	2.52/2.52	10	1.64	210
NLS322522-680□	68	15	2.52/2.52	9	2.80	189
NLS322522-101□	100	15	0.796/0.796	6	3.70	145
NLS322522-151□	150	15	0.796/0.796	5	6.10	120
NLS322522-221□	220	15	0.796/0.796	4	8.40	100
NLS322522-331□	330	15	0.796/0.796	3.5	12.3	80
NLS322522-471□	470	15	0.796/0.796	2.8	22.0	75
NLS322522-681□	680	15	0.796/0.796	2	28.0	65

Electrical Characteristics (NLS453232 TYPE)

Part No.	INDUCTANC E (μ H)	Q min	Test Frequency L,Q(MHz)	SRF (MHz) min.	DCR () Max.	Idc (mA) Max.
NLS453232-1R0□	1.0	10	7.96/7.96	200	0.11	1050
NLS453232-1R2□	1.2	10	7.96/7.96	155	0.12	1000
NLS453232-1R5□	1.5	10	7.96/7.96	130	0.15	950
NLS453232-1R8□	1.8	10	7.96/7.96	100	0.16	900
NLS453232-2R2□	2.2	10	7.96/7.96	80	0.18	850
NLS453232-2R7□	2.7	10	7.96/7.96	55	0.20	800
NLS453232-3R3□	3.3	10	7.96/7.96	45	0.22	750
NLS453232-3R9□	3.9	10	7.96/7.96	40	0.24	700
NLS453232-4R7□	4.7	10	7.96/7.96	35	0.27	650
NLS453232-5R6□	5.6	10	7.96/7.96	30	0.30	650
NLS453232-6R8□	6.8	10	7.96/7.96	28	0.35	600

Electrical Characteristics (NLS453232 TYPE)

Part No.	INDUCTANC E (μ H)	Q min	Test Frequency L,Q(MHz)	SRF (MHz) min.	DCR () Max.	Idc (mA) Max.
NLS453232-8R2□	8.2	10	7.96/7.96	25	0.40	600
NLS453232-100□	10	10	2.52/2.52	22	0.50	550
NLS453232-120□	12	10	2.52/2.52	21	0.60	500
NLS453232-150□	15	10	2.52/2.52	20	0.70	450
NLS453232-180□	18	10	2.52/2.52	18	0.80	400
NLS453232-220□	22	10	2.52/2.52	17	0.90	370
NLS453232-270□	27	10	2.52/2.52	15	1.20	330
NLS453232-330□	33	10	2.52/2.52	14	1.40	300
NLS453232-390□	39	10	2.52/2.52	12	1.60	280
NLS453232-470□	47	10	2.52/2.52	11.5	1.90	260
NLS453232-560□	56	10	2.52/2.52	10.5	2.20	240
NLS453232-680□	68	10	2.52/2.52	9.0	2.60	220
NLS453232-820□	82	10	2.52/2.52	8.5	3.50	200
NLS453232-101□	100	20	0.796/0.796	7.0	4.00	180
NLS453232-121□	120	20	0.796/0.796	6.5	4.50	160
NLS453232-151□	150	20	0.796/0.796	6.0	6.50	140
NLS453232-181□	180	20	0.796/0.796	5.5	7.50	120
NLS453232-221□	220	20	0.796/0.796	5.0	9.00	120
NLS453232-271□	270	20	0.796/0.796	4.5	11.0	100
NLS453232-331□	330	20	0.796/0.796	4.0	13.0	90

Electrical Characteristics (NLS565050 TYPE)

Part No.	INDUCTANC E (μ H)	Q min	Test Frequency L,Q(MHz)	SRF (MHz) min.	DCR () Max.	Idc (mA) Max.
NLS565050-1R0□	1.0	10	7.96/7.96	95	0.03	1800
NLS565050-1R2□	1.2	10	7.96/7.96	70	0.035	1700
NLS565050-1R5□	1.5	10	7.96/7.96	55	0.04	1600
NLS565050-1R8□	1.8	10	7.96/7.96	47	0.05	1400
NLS565050-2R2□	2.2	10	7.96/7.96	42	0.06	1300
NLS565050-2R7□	2.7	10	7.96/7.96	37	0.07	1200
NLS565050-3R3□	3.3	10	7.96/7.96	34	0.08	1120
NLS565050-3R9□	3.9	10	7.96/7.96	32	0.09	1050
NLS565050-4R7□	4.7	10	7.96/7.96	29	0.11	950

Electrical Characteristics (NLS565050 TYPE)

Part No.	INDUCTANC E (μ H)	Q min	Test Frequency L,Q(MHz)	SRF (MHz) min.	DCR (Ω) Max.	Idc (mA) Max.
NLS565050-5R6□	5.6	10	7.96/7.96	26	0.13	880
NLS565050-6R8□	6.8	10	7.96/7.96	24	0.15	810
NLS565050-8R2□	8.2	10	7.96/7.96	22	0.18	750
NLS565050-100□	10	10	2.52/2.52	19	0.21	690
NLS565050-120□	12	10	2.52/2.52	17	0.25	630
NLS565050-150□	15	10	2.52/2.52	16	0.30	580
NLS565050-180□	18	10	2.52/2.52	14	0.36	530
NLS565050-220□	22	10	2.52/2.52	13	0.43	480
NLS565050-270□	27	10	2.52/2.52	11.5	0.52	440
NLS565050-330□	33	10	2.52/2.52	10.5	0.62	400
NLS565050-390□	39	10	2.52/2.52	9.5	0.72	370
NLS565050-470□	47	10	2.52/2.52	8.5	0.85	340
NLS565050-560□	56	10	2.52/2.52	7.8	1.00	310
NLS565050-680□	68	10	2.52/2.52	7	1.2	290
NLS565050-820□	82	10	2.52/2.52	6.4	1.4	270
NLS565050-101□	100	20	0.796/0.796	6	1.6	250
NLS565050-121□	120	20	0.796/0.796	5.4	1.9	230
NLS565050-151□	150	20	0.796/0.796	4.8	2.2	210
NLS565050-181□	180	20	0.796/0.796	4.4	2.8	190
NLS565050-221□	220	20	0.796/0.796	3.9	3.4	170
NLS565050-271□	270	20	0.796/0.796	3.6	4.2	155
NLS565050-331□	330	20	0.796/0.796	3.2	4.9	140
NLS565050-391□	390	20	0.796/0.796	2.9	5.8	130
NLS565050-471□	470	20	0.796/0.796	2.6	7	120
NLS565050-561□	560	20	0.796/0.796	2.4	8.5	110
NLS565050-681□	680	20	0.796/0.796	2.2	10	100
NLS565050-821□	820	20	0.796/0.796	2	13	90
NLS565050-102□	1000	20	0.796/0.796	1.8	15	85

On-Board Type EMI Supperssion Filters / CML TYPE

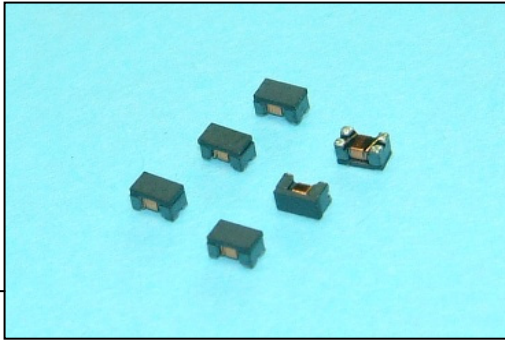

Applications :

Common mode noise suppression of signal lines in high speed and high density digital equipment such as personal computers and peripherals.

1. Product Identification

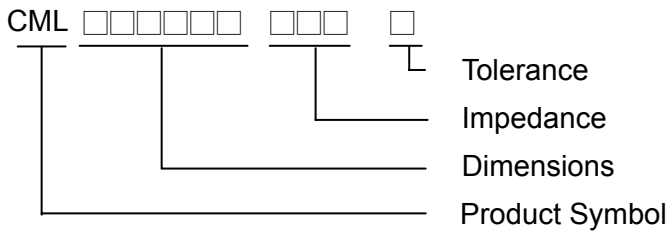

2. Shape and Dimension

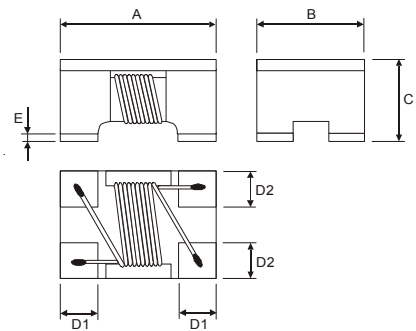

Dimensions in mm

TYPE	A ±0.2	B ±0.2	C ±0.2	D1	D2	E
CML201212 TYPE	2.0	1.2	1.2	0.45 (typ.)	0.40 (typ.)	0.17 (typ.)
CML321620 TYPE	3.2	1.6	2.0	0.60 (typ.)	0.60 (typ.)	0.17 (typ.)

3. Electrical Characteristics (CML201212T TYPE)

Part No.	Common mode Impedance (Ω)	DC Resonant (Ω) Max	Rate Current (mA) Max	Rated Voltage (Vdc)	Insulation Resistance (mΩ)(Min)	TEST FREQ (MHz)
CML201212T-300M	30±20%	0.2	450	50	10	100
CML201212T-670M	67±20%	0.25	400	50	10	100
CML201212T-900M	90±20%	0.35	330	50	10	100
CML201212T-121M	120±20%	0.3	370	50	10	100
CML201212T-161M	160±20%	0.4	300	50	10	100
CML201212T-181M	180±20%	0.35	330	50	10	100
CML201212T-201M	200±20%	0.35	330	50	10	100
CML201212T-221M	220±20%	0.35	310	50	10	100
CML201212T-261M	260±20%	0.4	300	50	10	100
CML201212T-301M	300±20%	0.4	290	50	10	100
CML201212T-361M	360±20%	0.45	280	50	10	100

Electrical Characteristics (CML201212T TYPE)

Part No.	Common mode Impedance (Ω)	DC Resonant (Ω) Max	Rate Current (mA) Max	Rated Voltage (Vdc)	Insulation Resistance (m Ω)(Min)	TEST FREQ (MHz)
CML201212T-371M	370 \pm 20%	0.45	280	50	10	100
CML201212T-501M	500 \pm 20%	0.55	170	50	10	100
CML201212T-671M	670 \pm 20%	0.6	140	50	10	100
CML201212T-901M	900 \pm 20%	0.6	80	50	10	100

Electrical Characteristics (CML321620T TYPE)

Part No.	Common mode Impedance (Ω)	DC Resonant (Ω) Max	Rate Current (mA) Max	Rated Voltage (Vdc)	Insulation Resistance (m Ω)(Min)	TEST FREQ (MHz)
CML321620T-900M	90 \pm 20%	0.3	370	50	10	100
CML321620T-121M	120 \pm 20%	0.3	370	50	10	100
CML321620T-161M	160 \pm 20%	0.4	340	50	10	100
CML321620T-221M	220 \pm 20%	0.4	320	50	10	100
CML321620T-261M	260 \pm 20%	0.5	310	50	10	100
CML321620T-601M	600 \pm 20%	0.8	260	50	10	100
CML321620T-102M	1000 \pm 20%	1.0	230	50	10	100
CML321620T-222M	2200 \pm 20%	1.2	200	50	10	100

4. Curves

CML201212 Series

CML201212-900

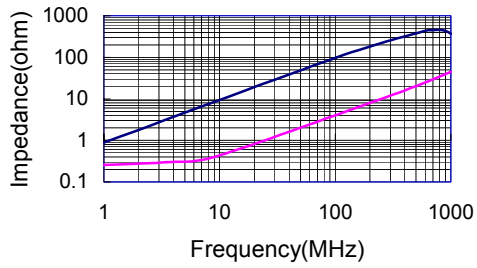

CML321620 Series

CML321620-900

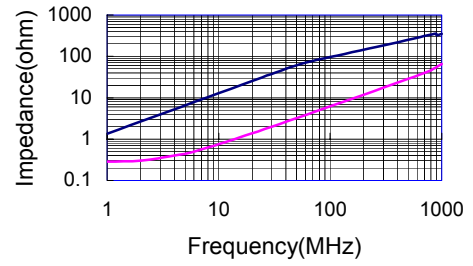

CML201212-161

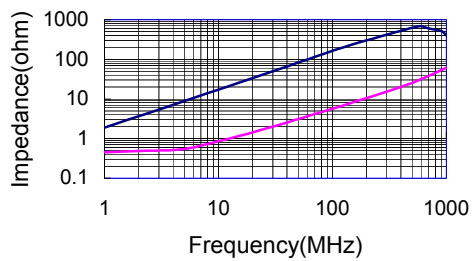

CML321620-221

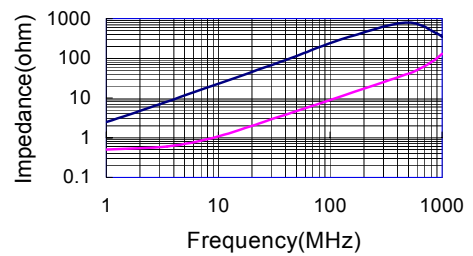

CML201212-221

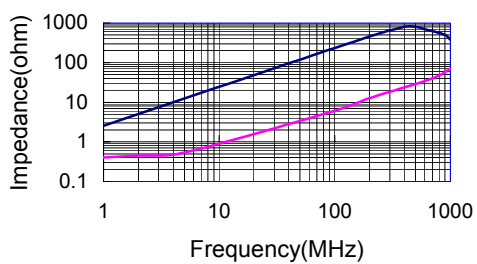

CML321620-221

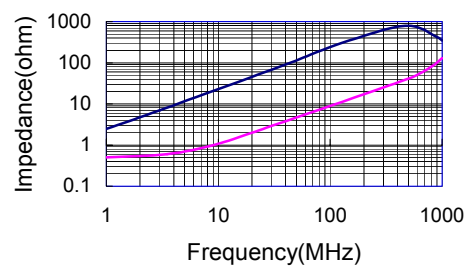

Chip Bead Array / CA TYPE

Features:

1. Monolithic inorganic material construction.
2. Closed magnetic circuit avoids crosstalk.
3. Excellent solderability and heat resistance.
4. High reliability.

Applications:

Noise elimination for four I/O lines of notebook PCs, digital TVs and VTRs, printers, hard disk drives, personal computers and other general consumer and computers products.

Product Identification :

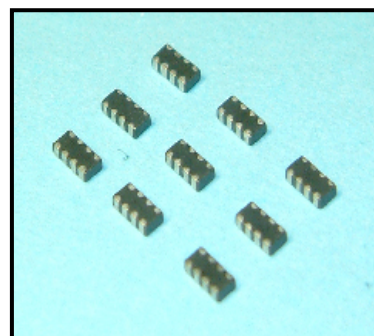
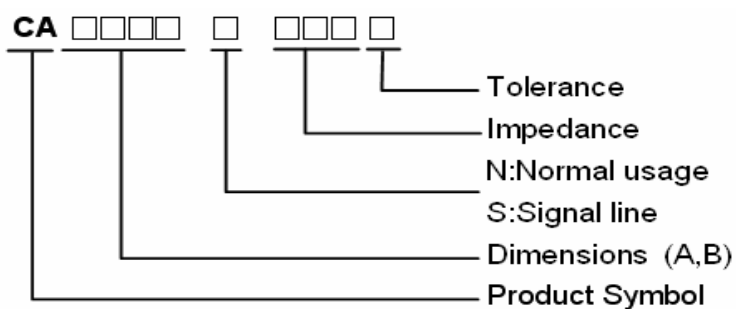

Shape and Dimension

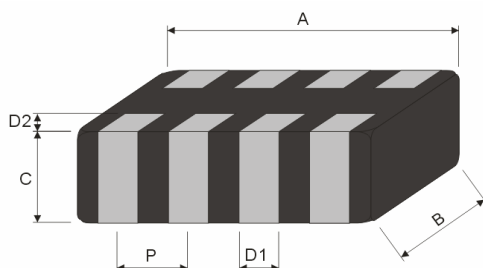

Schematic

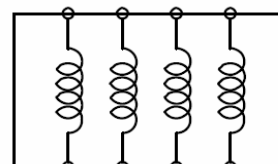

Dimensions in mm

TYPE	A(mm)	B(mm)	C(mm)	D1(mm)	D2(mm)	P(mm)
CA3216	3.2±0.2	1.6±0.2	0.9±0.2	0.4±0.15	0.2±0.1	0.8±0.1

Recommended Reflow

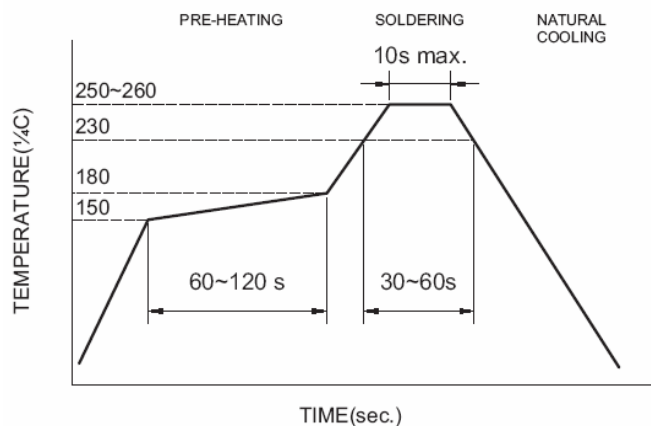

Chip Bead Array / CA TYPE

Electrical Characteristics (CA3216N TYPE)

Part No.	IMPEDANCE ($\Omega \pm 25\%$)	Test frequency	DCR (Ω) Max	Rated Current (mA) Max
CA3216N-300Y	30	100 MHz	0.20	500
CA3216N-600Y	60	100 MHz	0.25	400
CA3216N-121Y	120	100 MHz	0.30	350
CA3216N-301Y	300	100 MHz	0.40	250
CA3216N-601Y	600	100 MHz	0.50	200
CA3216N-102Y	1000	100 MHz	0.75	150

Electrical Characteristics (CA3216S TYPE)

Part No.	IMPEDANCE ($\Omega \pm 25\%$)	Test frequency	DCR (Ω) Max	Rated Current (mA) Max
CA3216S-300Y	30	100 MHz	0.25	400
CA3216S-600Y	60	100 MHz	0.30	300
CA3216S-121Y	120	100 MHz	0.40	250
CA3216S-301Y	300	100 MHz	0.50	200
CA3216S-601Y	600	100 MHz	0.60	150

Chip Bead Array / CA TYPE

4. Reliability and Test Conditions(可靠性測試條件)

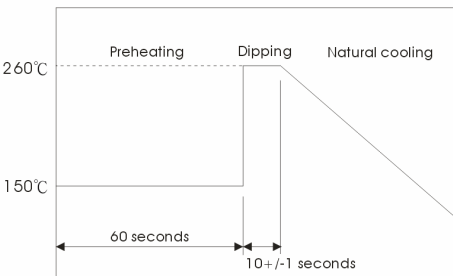
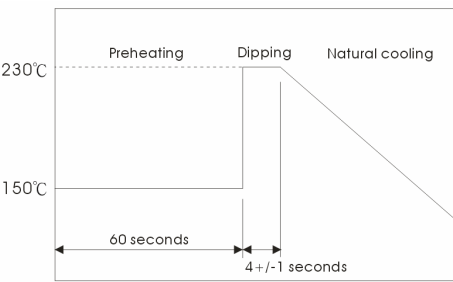
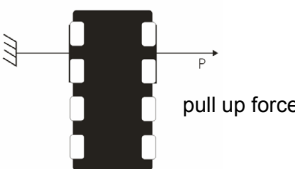
ITEM	Performance	Test Condition						
Operating Temperature	-55~+125°C	normal standard						
Storage temperature and humidity conditions	40°C Max.,70%RH Max	normal standard						
Soldering Heat Resistance	The chip shall not be cracks. More than 70% of terminal electrode shall be covered with solder. Impedance : Tolerance should be within +/-20% from the initial value .	Preheat : 150°C duration 60 sec. Solder : H63A Solder temperature : 260±5°C Flux : rosin Dip time : 10±1 sec. 						
Solderability	More than 90% of the terminal electrode shall be covered with solder.	Preheat : 150°C , 60 sec. Solder : H63A Solder temperature : 230±5°C Flux : rosin Dipping time : 4±1 sec. 						
Thermal strength	The terminal electrode and the ferrite shall not be damaged by the forces which be applied on the right side conditions. 	<table border="1" data-bbox="853 1713 1428 1825"> <thead> <tr> <th>Type</th> <th>P (kgf)</th> <th>Time (s)</th> </tr> </thead> <tbody> <tr> <td>CA3216N</td> <td>0.5</td> <td>30±5</td> </tr> </tbody> </table>	Type	P (kgf)	Time (s)	CA3216N	0.5	30±5
Type	P (kgf)	Time (s)						
CA3216N	0.5	30±5						

Chip Bead Array / CA TYPE

Packing Specifications

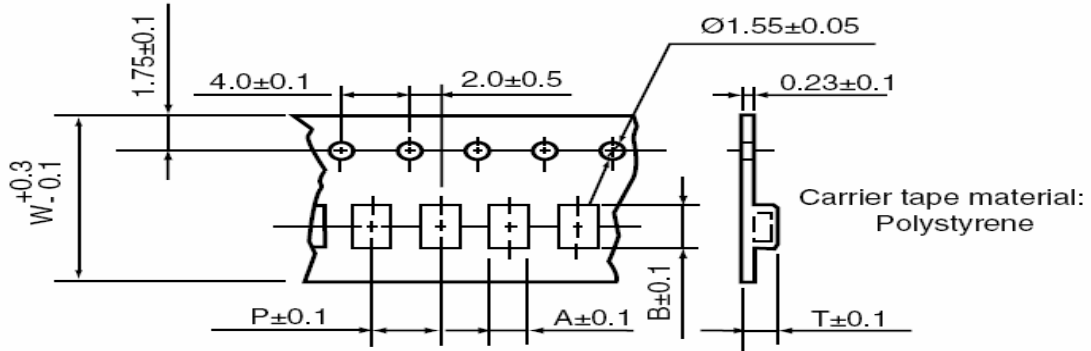

TYPE	Packaging Quantity		Tape Dimension				
	Pcs / Reel	Inner box	A	B	W	P	T
CA3216	3000	15000	1.77	3.4	8	4	1.04

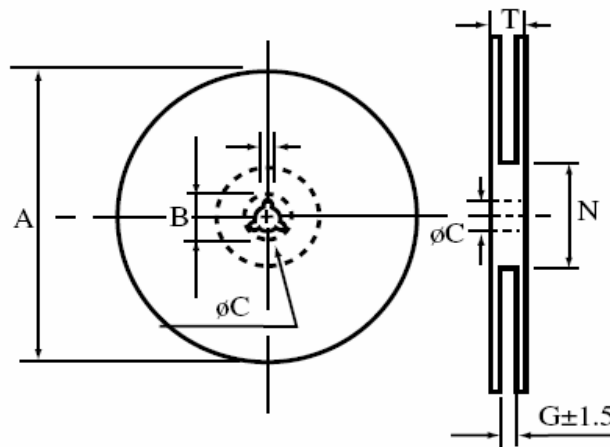

TYPE	Reel Dimension					
	A	B	C	G	N	T
8mm	178±2	21.0±0.8	13.0±0.8	10	75	12.5
12mm	178±2	21.0±0.8	13.0±0.8	14	75	16.5

SMD High Current Power Inductors / PIH TYPE

Features:

1. To be high saturation for surface mounting. (飽和特性佳)
2. Surface mount inductor with high current rating. (表面黏著型式且具高額定電流之電感)
3. Low resistance to keep power loss minimum. (低電阻使功率損失降至最低)
4. Packed in embossed carrier tape and can be used by automatic mounting machine. (捲軸包裝，可用於自動插件機器)

Applications:

LCD driving circuits (DC-DC converters) such as notebook-sized personal computers, portable terminal equipment, game units.

Product Identification :

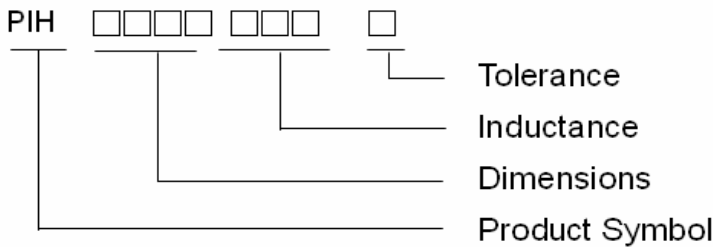

Shape and Dimension

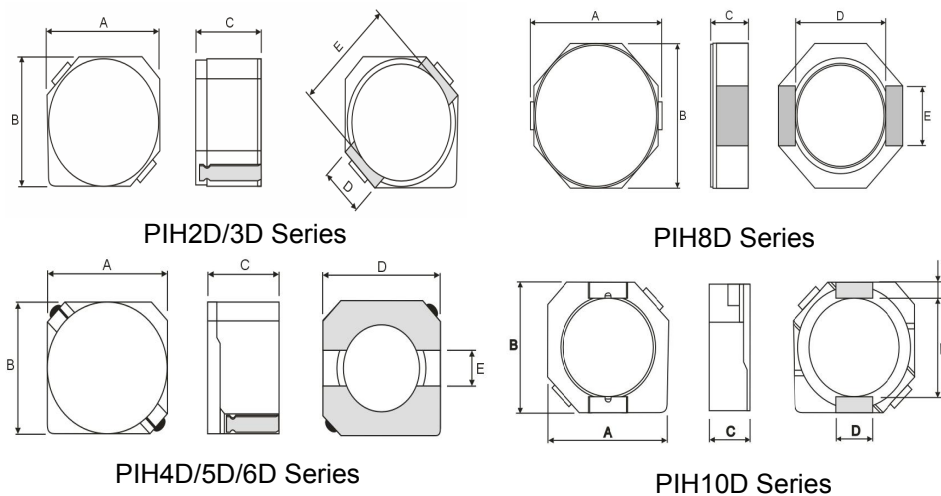

Schematic

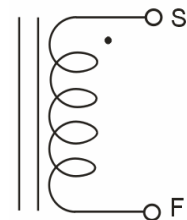

Dimensions in mm

TYPE	A(mm)	B(mm)	C(mm)	D(mm)	E(mm)	TYPE	A(mm)	B(mm)	C(mm)	D(mm)	E(mm)
PIH2D11	3.20 Max	3.20 Max	1.30 Max	1.00 Typ.	2.10 Typ.	PIH6D28	7.00 Max	7.00 Max	3.00 Max	6.50 Typ.	2.00 Typ.
PIH2D14	3.20 Max	3.20 Max	1.60 Max	1.00 Typ.	2.10 Typ.	PIH6D38	7.00 Max	7.00 Max	4.00 Max	6.50 Typ.	2.00 Typ.
PIH2D18	3.20 Max	3.20 Max	2.00 Max	1.00 Typ.	2.10 Typ.	PIH8D28	9.00 Max	8.30 Max	3.00 Max	6.30 Typ.	4.00 Typ.
PIH3D11	4.00 Max	4.00 Max	1.30 Max	1.10 Typ.	2.80 Typ.	PIH8D38	9.00 Max	8.30 Max	4.00 Max	6.30 Typ.	4.00 Typ.
PIH3D16	4.00 Max	4.00 Max	1.90 Max	1.10 Typ.	2.80 Typ.	PIH8D43	9.00 Max	8.30 Max	4.50 Max	6.30 Typ.	4.00 Typ.
PIH3D28	4.00 Max	4.00 Max	3.00 Max	1.10 Typ.	2.80 Typ.	PIH10D30	10.3 Max	10.5 Max	3.0 Max	3	7.7
PIH4D18	5.00 Max	5.00 Max	2.00 Max	4.50 Typ.	1.50 Typ.	PIH10D40	10.3 Max	10.5 Max	4.0 Max	3	7.7
PIH4D28	5.00 Max	5.00 Max	3.00 Max	4.50 Typ.	1.50 Typ.	PIH10D50	10.3 Max	10.5 Max	5.0 Max	3	7.7
PIH5D18	6.00 Max	6.00 Max	2.00 Max	5.50 Typ.	2.00 Typ.	PIH10D60	10.3 Max	10.6 Max	6.0 Max	3	7.7
PIH5D28	6.00 Max	6.00 Max	3.00 Max	5.50 Typ.	2.00 Typ.	PIH10D68	10.3 Max	10.7 Max	6.8 Max	3	7.7

SMD High Current Power Inductors / PIH TYPE

Land Patterns for Reflow Soldering

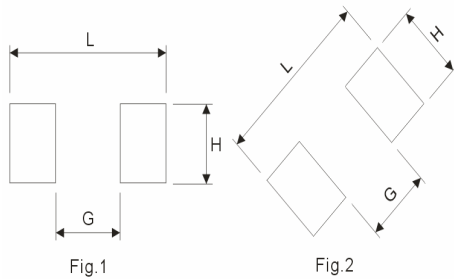

TYPE	L(mm)	G(mm)	H(mm)	Fig
PIH2D Series	4.30	1.70	1.30	Fig.2
PIH3D Series	5.20	2.40	1.50	Fig.2
PIH4D Series	5.30	1.50	5.30	Fig.1
PIH5D Series	6.30	2.00	6.30	Fig.1
PIH6D Series	7.30	2.00	7.30	Fig.1
PIH8D Series	10.10	6.10	5.00	Fig.1
PIH10D Series	10.70	7.30	3.60	Fig.1

Recommended Reflow

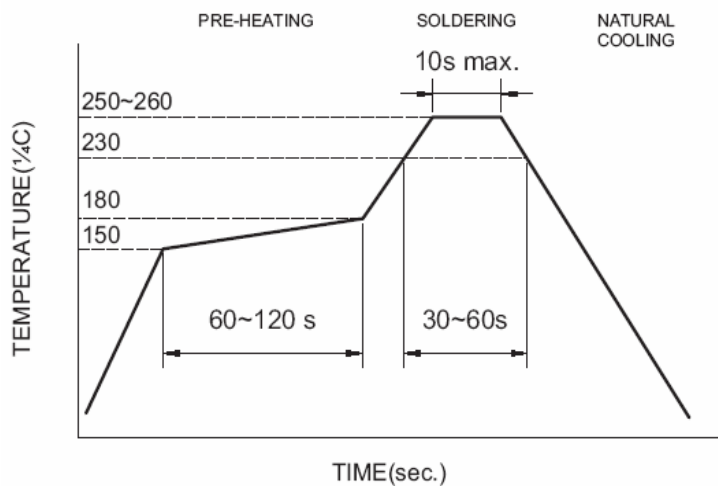

SMD High Current Power Inductors / PIH TYPE

Electrical Characteristics (PIH2D11 TYPE)

Part No.	INDUCTANCE (μH)	IDC (A)	DCR (m Ω) Max	Test frequency
PIH2D11-1R5□	1.5	1.48	68	100KHz/0.1V
PIH2D11-2R2□	2.2	1.27	98	100KHz/0.1V
PIH2D11-3R3□	3.3	1.02	123	100KHz/0.1V
PIH2D11-4R7□	4.7	0.88	170	100KHz/0.1V
PIH2D11-6R8□	6.8	0.78	260	100KHz/0.1V
PIH2D11-100□	10.0	0.65	400	100KHz/0.1V

Electrical Characteristics (PIH2D14 TYPE)

Part No.	INDUCTANCE (μH)	IDC (A)	DCR (m Ω) Max	Test frequency
PIH2D14-1R5□	1.5	2.00	63	100KHz/0.1V
PIH2D14-1R8□	1.8	1.80	75	100KHz/0.1V
PIH2D14-2R2□	2.2	1.60	94	100KHz/0.1V
PIH2D14-2R7□	2.7	1.40	106	100KHz/0.1V
PIH2D14-3R3□	3.3	1.24	125	100KHz/0.1V
PIH2D14-3R9□	3.9	1.12	138	100KHz/0.1V
PIH2D14-4R7□	4.7	1.00	169	100KHz/0.1V
PIH2D14-5R6□	5.6	0.98	188	100KHz/0.1V
PIH2D14-6R8□	6.8	0.92	213	100KHz/0.1V
PIH2D14-8R2□	8.2	0.80	281	100KHz/0.1V
PIH2D14-100□	10.0	0.76	294	100KHz/0.1V
PIH2D14-120□	12.0	0.64	394	100KHz/0.1V

Electrical Characteristics (PIH2D18 TYPE)

Part No.	INDUCTANCE (μH)	IDC (A)	DCR (m Ω) Max	Test frequency
PIH2D18-2R2□	2.2	2.30	41	100KHz/0.1V
PIH2D18-3R3□	3.3	2.10	54	100KHz/0.1V
PIH2D18-4R7□	4.7	1.65	78	100KHz/0.1V
PIH2D18-6R8□	6.8	1.32	106	100KHz/0.1V
PIH2D18-100□	10.0	1.00	180	100KHz/0.1V
PIH2D18-150□	15.0	0.80	220	100KHz/0.1V
PIH2D18-220□	22.0	0.68	320	100KHz/0.1V
PIH2D18-330□	33.0	0.56	460	100KHz/0.1V
PIH2D18-470□	47.0	0.48	660	100KHz/0.1V

Electrical Characteristics (PIH3D11 TYPE)

Part No.	INDUCTANCE (μH)	IDC (A)	DCR (m Ω) Max	Test frequency
PIH3D11-1R0□	1.0	1.71	70	100KHz/0.1V
PIH3D11-1R5□	1.5	1.40	87	100KHz/0.1V
PIH3D11-2R2□	2.2	1.21	120	100KHz/0.1V

SMD High Current Power Inductors / PIH TYPE

Electrical Characteristics (PIH3D11 TYPE)

Part No.	INDUCTANCE (μ H)	IDC (A)	DCR (m Ω) Max	Test frequency
PIH3D11-3R3□	3.3	0.91	173	100KHz/0.1V
PIH3D11-4R7□	4.7	0.81	236	100KHz/0.1V
PIH3D11-6R8□	6.8	0.64	289	100KHz/0.1V
PIH3D11-100□	10.0	0.55	395	100KHz/0.1V
PIH3D11-150□	15.0	0.43	605	100KHz/0.1V
PIH3D11-220□	22.0	0.34	920	100KHz/0.1V
PIH3D11-330□	33.0	0.24	1520	100KHz/0.1V
PIH3D11-470□	47.0	0.18	2380	100KHz/0.1V
PIH3D11-680□	68.0	0.14	3050	100KHz/0.1V
PIH3D11-101□	100.0	0.10	3650	100KHz/0.1V

Electrical Characteristics (PIH3D16 TYPE)

Part No.	INDUCTANCE (μ H)	IDC (A)	DCR (m Ω) Max	Test frequency
PIH3D16-3R3□	3.3	2.00	66	100KHz/0.1V
PIH3D16-3R9□	3.9	1.75	81	100KHz/0.1V
PIH3D16-4R7□	4.7	1.72	91	100KHz/0.1V
PIH3D16-5R6□	5.6	1.64	102	100KHz/0.1V
PIH3D16-6R8□	6.8	1.30	130	100KHz/0.1V
PIH3D16-8R2□	8.2	1.28	140	100KHz/0.1V
PIH3D16-100□	10.0	1.07	190	100KHz/0.1V
PIH3D16-120□	12.0	0.98	205	100KHz/0.1V
PIH3D16-150□	15.0	0.87	272	100KHz/0.1V
PIH3D16-180□	18.0	0.76	327	100KHz/0.1V
PIH3D16-220□	22.0	0.66	356	100KHz/0.1V
PIH3D16-270□	27.0	0.60	470	100KHz/0.1V
PIH3D16-330□	33.0	0.55	560	100KHz/0.1V
PIH3D16-390□	39.0	0.47	700	100KHz/0.1V
PIH3D16-470□	47.0	0.45	755	100KHz/0.1V

Electrical Characteristics (PIH3D28 TYPE)

Part No.	INDUCTANCE (μ H)	IDC (A)	DCR (m Ω) Max	Test frequency
PIH3D28-100□	10.0	1.52	92	100KHz/0.1V
PIH3D28-120□	12.0	1.48	100	100KHz/0.1V
PIH3D28-150□	15.0	1.44	113	100KHz/0.1V
PIH3D28-180□	18.0	1.37	125	100KHz/0.1V
PIH3D28-220□	22.0	1.28	146	100KHz/0.1V
PIH3D28-270□	27.0	1.18	176	100KHz/0.1V
PIH3D28-330□	33.0	1.15	214	100KHz/0.1V
PIH3D28-390□	39.0	1.00	225	100KHz/0.1V
PIH3D28-470□	47.0	0.81	304	100KHz/0.1V
PIH3D28-560□	56.0	0.76	324	100KHz/0.1V

SMD High Current Power Inductors / PIH TYPE

Electrical Characteristics (PIH3D28 TYPE)

Part No.	INDUCTANCE (μH)	IDC (A)	DCR (m Ω) Max	Test frequency
PIH3D28-680□	68.0	0.60	472	100KHz/0.1V
PIH3D28-820□	82.0	0.58	539	100KHz/0.1V
PIH3D28-101□	100.0	0.52	608	100KHz/0.1V
PIH3D28-121□	120.0	0.50	757	100KHz/0.1V
PIH3D28-151□	150.0	0.48	882	100KHz/0.1V
PIH3D28-181□	180.0	0.42	1130	100KHz/0.1V
PIH3D28-221□	220.0	0.36	1269	100KHz/0.1V

Electrical Characteristics (PIH4D18 TYPE)

Part No.	INDUCTANCE (μH)	IDC (A)	DCR (m Ω) Max	Test frequency
PIH4D18-1R0□	1.0	1.72	45	100KHz/0.1V
PIH4D18-2R2□	2.2	1.32	75	100KHz/0.1V
PIH4D18-2R7□	2.7	1.28	105	100KHz/0.1V
PIH4D18-3R3□	3.3	1.04	110	100KHz/0.1V
PIH4D18-3R9□	3.9	0.88	155	100KHz/0.1V
PIH4D18-4R7□	4.7	0.84	162	100KHz/0.1V
PIH4D18-5R6□	5.6	0.80	170	100KHz/0.1V
PIH4D18-6R8□	6.8	0.76	200	100KHz/0.1V
PIH4D18-8R2□	8.2	0.68	245	100KHz/0.1V
PIH4D18-100□	10.0	0.61	200	100KHz/0.1V
PIH4D18-120□	12.0	0.56	210	100KHz/0.1V
PIH4D18-150□	15.0	0.50	240	100KHz/0.1V
PIH4D18-180□	18.0	0.48	338	100KHz/0.1V
PIH4D18-220□	22.0	0.41	397	100KHz/0.1V
PIH4D18-270□	27.0	0.35	441	100KHz/0.1V
PIH4D18-330□	33.0	0.32	694	100KHz/0.1V
PIH4D18-390□	39.0	0.30	709	100KHz/0.1V
PIH4D18-470□	47.0	0.28	922	100KHz/0.1V
PIH4D18-560□	56.0	0.26	1080	100KHz/0.1V
PIH4D18-680□	68.0	0.24	1300	100KHz/0.1V
PIH4D18-820□	82.0	0.22	1550	100KHz/0.1V
PIH4D18-101□	100.0	0.20	1730	100KHz/0.1V

Electrical Characteristics (PIH4D28 TYPE)

Part No.	INDUCTANCE (μH)	IDC (A)	DCR (m Ω) Max	Test frequency
PIH4D28-1R2□	1.2	2.56	24	100KHz/0.1V
PIH4D28-1R8□	1.8	2.20	28	100KHz/0.1V
PIH4D28-2R2□	2.2	2.04	31	100KHz/0.1V
PIH4D28-2R7□	2.7	1.60	43	100KHz/0.1V
PIH4D28-3R3□	3.3	1.57	49	100KHz/0.1V
PIH4D28-3R9□	3.9	1.44	65	100KHz/0.1V
PIH4D28-4R7□	4.7	1.32	72	100KHz/0.1V

SMD High Current Power Inductors / PIH TYPE

Electrical Characteristics (PIH4D28 TYPE)

Part No.	INDUCTANCE (μ H)	IDC (A)	DCR (m Ω) Max	Test frequency
PIH4D28-5R6□	5.6	1.17	101	100KHz/0.1V
PIH4D28-6R8□	6.8	1.12	109	100KHz/0.1V
PIH4D28-8R2□	8.2	1.04	118	100KHz/0.1V
PIH4D28-100□	10.0	1.00	128	100KHz/0.1V
PIH4D28-120□	12.0	0.84	132	100KHz/0.1V
PIH4D28-150□	15.0	0.76	149	100KHz/0.1V
PIH4D28-180□	18.0	0.72	166	100KHz/0.1V
PIH4D28-220□	22.0	0.70	235	100KHz/0.1V
PIH4D28-270□	27.0	0.58	261	100KHz/0.1V
PIH4D28-330□	33.0	0.56	378	100KHz/0.1V
PIH4D28-390□	39.0	0.50	384	100KHz/0.1V
PIH4D28-680□	68.0	0.35	699	100KHz/0.1V
PIH4D28-820□	82.0	0.32	915	100KHz/0.1V
PIH4D28-101□	100.0	0.29	1020	100KHz/0.1V
PIH4D28-121□	120.0	0.27	1270	100KHz/0.1V
PIH4D28-151□	150.0	0.24	1350	100KHz/0.1V

Electrical Characteristics (PIH5D18 TYPE)

Part No.	INDUCTANCE (μ H)	IDC (A)	DCR (m Ω) Max	Test frequency
PIH5D18-4R1□	4.1	1.95	57	10KHz/0.1V
PIH5D18-5R4□	5.4	1.60	76	10KHz/0.1V
PIH5D18-6R2□	6.2	1.40	96	10KHz/0.1V
PIH5D18-8R9□	8.9	1.25	116	10KHz/0.1V
PIH5D18-100□	10.0	1.20	124	10KHz/0.1V
PIH5D18-120□	12.0	1.10	153	10KHz/0.1V
PIH5D18-150□	15.0	0.97	196	10KHz/0.1V
PIH5D18-180□	18.0	0.85	210	10KHz/0.1V
PIH5D18-220□	22.0	0.80	290	10KHz/0.1V
PIH5D18-270□	27.0	0.75	330	10KHz/0.1V
PIH5D18-330□	33.0	0.65	386	10KHz/0.1V
PIH5D18-390□	39.0	0.57	520	10KHz/0.1V
PIH5D18-470□	47.0	0.54	595	10KHz/0.1V
PIH5D18-560□	56.0	0.50	665	10KHz/0.1V
PIH5D18-680□	68.0	0.43	840	10KHz/0.1V
PIH5D18-820□	82.0	0.41	978	10KHz/0.1V
PIH5D18-101□	100.0	0.36	1200	10KHz/0.1V
PIH5D18-121□	120.0	0.33	1500	10KHz/0.1V
PIH5D18-151□	150.0	0.31	1710	10KHz/0.1V
PIH5D18-181□	180.0	0.28	2240	10KHz/0.1V
PIH5D18-221□	220.0	0.23	2440	10KHz/0.1V
PIH5D18-331□	330.0	0.18	4340	10KHz/0.1V

SMD High Current Power Inductors / PIH TYPE

Electrical Characteristics (PIH5D28 TYPE)

Part No.	INDUCTANCE (μ H)	IDC (A)	DCR (m Ω) Max	Test frequency
PIH5D28-2R6□	2.6	2.60	18	10KHz/0.1V
PIH5D28-3R0□	3.0	2.40	24	10KHz/0.1V
PIH5D28-4R2□	4.2	2.20	31	10KHz/0.1V
PIH5D28-5R3□	5.3	1.90	38	10KHz/0.1V
PIH5D28-6R2□	6.2	1.80	45	10KHz/0.1V
PIH5D28-8R2□	8.2	1.60	53	10KHz/0.1V
PIH5D28-100□	10.0	1.30	65	10KHz/0.1V
PIH5D28-120□	12.0	1.20	76	10KHz/0.1V
PIH5D28-150□	15.0	1.10	103	10KHz/0.1V
PIH5D28-180□	18.0	1.00	110	10KHz/0.1V
PIH5D28-220□	22.0	0.90	122	10KHz/0.1V
PIH5D28-270□	27.0	0.85	175	10KHz/0.1V
PIH5D28-330□	33.0	0.75	189	10KHz/0.1V
PIH5D28-390□	39.0	0.70	212	10KHz/0.1V
PIH5D28-470□	47.0	0.62	260	10KHz/0.1V
PIH5D28-560□	56.0	0.58	305	10KHz/0.1V
PIH5D28-680□	68.0	0.52	355	10KHz/0.1V
PIH5D28-820□	82.0	0.46	463	10KHz/0.1V
PIH5D28-101□	100.0	0.42	520	10KHz/0.1V
PIH5D28-121□	120.0	0.40	560	10KHz/0.1V
PIH5D28-151□	150.0	0.35	680	10KHz/0.1V
PIH5D28-181□	180.0	0.32	930	10KHz/0.1V
PIH5D28-221□	220.0	0.30	1150	10KHz/0.1V
PIH5D28-271□	270.0	0.27	1560	10KHz/0.1V
PIH5D28-331□	330.0	0.25	1980	10KHz/0.1V
PIH5D28-391□	390.0	0.22	2500	10KHz/0.1V
PIH5D28-471□	470.0	0.20	2700	10KHz/0.1V
PIH5D28-561□	560.0	0.18	3120	10KHz/0.1V
PIH5D28-681□	680.0	0.16	4150	10KHz/0.1V

Electrical Characteristics (PIH6D28 TYPE)

Part No.	INDUCTANCE (μ H)	IDC (A)	DCR (m Ω) Max	Test frequency
PIH6D28-3R0□	3.0	3.00	24	10KHz/0.1V
PIH6D28-3R9□	3.9	2.60	27	10KHz/0.1V
PIH6D28-5R0□	5.0	2.40	31	10KHz/0.1V
PIH6D28-6R0□	6.0	2.25	35	10KHz/0.1V
PIH6D28-7R3□	7.3	2.10	54	10KHz/0.1V
PIH6D28-8R6□	8.6	1.85	58	10KHz/0.1V
PIH6D28-100□	10.0	1.70	65	10KHz/0.1V
PIH6D28-120□	12.0	1.55	70	10KHz/0.1V
PIH6D28-150□	15.0	1.40	84	10KHz/0.1V
PIH6D28-180□	18.0	1.32	95	10KHz/0.1V

SMD High Current Power Inductors / PIH TYPE

Electrical Characteristics (PIH6D28 TYPE)

Part No.	INDUCTANCE (μH)	IDC (A)	DCR (m Ω) Max	Test frequency
PIH6D28-220□	22.0	1.20	128	10KHz/0.1V
PIH6D28-270□	27.0	1.05	124	10KHz/0.1V
PIH6D28-330□	33.0	0.97	165	10KHz/0.1V
PIH6D28-390□	39.0	0.86	210	10KHz/0.1V
PIH6D28-470□	47.0	0.80	238	10KHz/0.1V
PIH6D28-560□	56.0	0.73	277	10KHz/0.1V
PIH6D28-680□	68.0	0.65	304	10KHz/0.1V
PIH6D28-820□	82.0	0.60	390	10KHz/0.1V
PIH6D28-101□	100.0	0.54	535	10KHz/0.1V
PIH6D28-121□	120.0	0.51	750	10KHz/0.1V
PIH6D28-151□	150.0	0.47	950	10KHz/0.1V
PIH6D28-181□	180.0	0.41	1200	10KHz/0.1V
PIH6D28-221□	220.0	0.37	1500	10KHz/0.1V
PIH6D28-271□	270.0	0.33	1700	10KHz/0.1V
PIH6D28-331□	330.0	0.28	2150	10KHz/0.1V
PIH6D28-391□	390.0	0.27	2250	10KHz/0.1V
PIH6D28-471□	470.0	0.21	3150	10KHz/0.1V
PIH6D28-561□	560.0	0.20	3750	10KHz/0.1V
PIH6D28-681□	680.0	0.20	5150	10KHz/0.1V

Electrical Characteristics (PIH6D38 TYPE)

Part No.	INDUCTANCE (μH)	IDC (A)	DCR (m Ω) Max	Test frequency
PIH6D38-3R3□	3.3	3.50	20	10KHz/0.1V
PIH6D38-5R0□	5.0	2.90	24	10KHz/0.1V
PIH6D38-6R2□	6.2	2.50	27	10KHz/0.1V
PIH6D38-7R4□	7.4	2.30	31	10KHz/0.1V
PIH6D38-8R7□	8.7	2.20	34	10KHz/0.1V
PIH6D38-100□	10.0	2.00	38	10KHz/0.1V
PIH6D38-120□	12.0	1.70	53	10KHz/0.1V
PIH6D38-150□	15.0	1.60	57	10KHz/0.1V
PIH6D38-180□	18.0	1.50	92	10KHz/0.1V
PIH6D38-220□	22.0	1.30	96	10KHz/0.1V
PIH6D38-270□	27.0	1.20	109	10KHz/0.1V
PIH6D38-330□	33.0	1.10	124	10KHz/0.1V
PIH6D38-390□	39.0	1.00	138	10KHz/0.1V
PIH6D38-470□	47.0	0.95	155	10KHz/0.1V
PIH6D38-560□	56.0	0.85	202	10KHz/0.1V
PIH6D38-680□	68.0	0.75	234	10KHz/0.1V
PIH6D38-820□	82.0	0.70	324	10KHz/0.1V
PIH6D38-101□	100.0	0.65	358	10KHz/0.1V
PIH6D38-121□	120.0	0.59	470	10KHz/0.1V
PIH6D38-151□	150.0	0.54	580	10KHz/0.1V

SMD High Current Power Inductors / PIH TYPE**Electrical Characteristics (PIH6D38 TYPE)**

Part No.	INDUCTANCE (μ H)	IDC (A)	DCR (m Ω) Max	Test frequency
PIH6D38-181□	180.0	0.49	690	10KHz/0.1V
PIH6D38-221□	220.0	0.43	890	10KHz/0.1V
PIH6D38-271□	270.0	0.40	1290	10KHz/0.1V
PIH6D38-331□	330.0	0.37	1700	10KHz/0.1V
PIH6D38-391□	390.0	0.34	1750	10KHz/0.1V
PIH6D38-471□	470.0	0.32	2200	10KHz/0.1V
PIH6D38-561□	560.0	0.29	2850	10KHz/0.1V
PIH6D38-681□	680.0	0.25	3200	10KHz/0.1V
PIH6D38-821□	820.0	0.22	4050	10KHz/0.1V
PIH6D38-102□	1000.0	0.20	5700	10KHz/0.1V

Electrical Characteristics (PIH8D28 TYPE)

Part No.	INDUCTANCE (μ H)	IDC (A)	DCR (m Ω) Max	Test frequency
PIH8D28-2R5□	2.5	6.40	15.6	100KHz/0.1V
PIH8D28-3R3□	3.3	6.00	18.2	100KHz/0.1V
PIH8D28-4R7□	4.7	4.50	24.7	100KHz/0.1V
PIH8D28-7R3□	7.3	3.40	39	100KHz/0.1V
PIH8D28-100□	10.0	3.20	47	100KHz/0.1V
PIH8D28-150□	15.0	2.35	69	100KHz/0.1V
PIH8D28-220□	22.0	1.85	99	100KHz/0.1V
PIH8D28-330□	33.0	1.49	156	100KHz/0.1V
PIH8D28-470□	47.0	1.30	195	100KHz/0.1V
PIH8D28-680□	68.0	0.98	286	100KHz/0.1V
PIH8D28-101□	100.0	0.80	980	100KHz/0.1V
PIH8D38-1R8□	1.8	6.80	15.6	100KHz/0.1V
PIH8D38-2R0□	2.0	6.00	17.5	100KHz/0.1V
PIH8D38-3R5□	3.5	5.20	24	100KHz/0.1V
PIH8D38-4R7□	4.7	4.40	29	100KHz/0.1V
PIH8D38-6R0□	6.0	4.00	32	100KHz/0.1V
PIH8D38-100□	10.0	3.20	48	100KHz/0.1V
PIH8D38-150□	15.0	2.50	67	100KHz/0.1V
PIH8D38-220□	22.0	2.00	105	100KHz/0.1V
PIH8D38-330□	33.0	1.60	157	100KHz/0.1V
PIH8D38-470□	47.0	1.42	189	100KHz/0.1V
PIH8D38-680□	68.0	1.08	290	100KHz/0.1V
PIH8D38-101□	100.0	0.88	410	100KHz/0.1V

Electrical Characteristics (PIH8D43 TYPE)

Part No.	INDUCTANCE (μ H)	IDC (A)	DCR (m Ω) Max	Test frequency
PIH8D43-2R0□	2.0	5.50	14	100KHz/0.1V
PIH8D43-3R9□	3.9	4.50	19	100KHz/0.1V
PIH8D43-4R7□	4.7	4.10	22	100KHz/0.1V

SMD High Current Power Inductors / PIH TYPE**Electrical Characteristics (PIH8D43 TYPE)**

Part No.	INDUCTANCE (μH)	IDC (A)	DCR (m Ω) Max	Test frequency
PIH8D43-6R8□	6.8	3.90	25	100KHz/0.1V
PIH8D43-100□	10.0	3.20	36	100KHz/0.1V
PIH8D43-150□	15.0	2.30	53	100KHz/0.1V
PIH8D43-220□	22.0	1.80	75	100KHz/0.1V
PIH8D43-330□	33.0	1.40	125	100KHz/0.1V
PIH8D43-470□	47.0	1.30	150	100KHz/0.1V
PIH8D43-680□	68.0	1.00	240	100KHz/0.1V
PIH8D43-101□	100.0	0.80	360	100KHz/0.1V

Electrical Characteristics (PIH10D30 TYPE)

Part No.	INDUCTANCE (μH)	IDC (A)	DCR (m Ω) Max	Test frequency
PIH10D30-R80□	0.8	8.30	5.7	100KHz/0.1V
PIH10D30-1R5□	1.5	5.80	11	100KHz/0.1V
PIH10D30-2R2□	2.2	5.10	16.9	100KHz/0.1V
PIH10D30-3R3□	3.3	4.70	21	100KHz/0.1V
PIH10D30-4R7□	4.7	4.00	30	100KHz/0.1V
PIH10D30-6R8□	6.8	3.60	35	100KHz/0.1V
PIH10D30-8R2□	8.2	3.00	50	100KHz/0.1V
PIH10D30-100□	10.0	2.80	59	100KHz/0.1V
PIH10D30-150□	15.0	2.05	91	100KHz/0.1V
PIH10D30-220□	22.0	1.60	143	100KHz/0.1V
PIH10D30-330□	33.0	1.35	202	100KHz/0.1V
PIH10D30-470□	47.0	1.20	299	100KHz/0.1V
PIH10D30-560□	56.0	1.15	325	100KHz/0.1V
PIH10D30-680□	68.0	0.95	429	100KHz/0.1V
PIH10D30-820□	82.0	0.80	494	100KHz/0.1V
PIH10D30-101□	100.0	0.70	683	100KHz/0.1V
PIH10D30-121□	120.0	0.65	754	100KHz/0.1V
PIH10D30-151□	150.0	0.51	871	100KHz/0.1V

Electrical Characteristics (PIH10D40 TYPE)

Part No.	INDUCTANCE (μH)	IDC (A)	DCR (m Ω) Max	Test frequency
PIH10D40-1R5□	1.5	6.50	8.1	100KHz/0.1V
PIH10D40-2R5□	2.5	6.10	10.5	100KHz/0.1V
PIH10D40-3R8□	3.8	5.50	13	100KHz/0.1V
PIH10D40-5R2□	5.2	5.40	22	100KHz/0.1V
PIH10D40-7R0□	7.0	4.50	27	100KHz/0.1V
PIH10D40-100□	10.0	3.80	35	100KHz/0.1V
PIH10D40-150□	15.0	3.10	50	100KHz/0.1V
PIH10D40-220□	22.0	2.50	73	100KHz/0.1V
PIH10D40-330□	33.0	2.20	93	100KHz/0.1V
PIH10D40-470□	47.0	1.90	128	100KHz/0.1V

SMD High Current Power Inductors / PIH TYPE

Electrical Characteristics (PIH10D50 TYPE)

Part No.	INDUCTANCE (μH)	IDC (A)	DCR (m Ω) Max	Test frequency
PIH10D40-680□	68.0	1.42	213	100KHz/0.1V
PIH10D40-101□	100.0	1.25	304	100KHz/0.1V
PIH10D40-151□	150.0	0.85	506	100KHz/0.1V
PIH10D40-221□	220.0	0.70	756	100KHz/0.1V
PIH10D40-331□	330.0	0.52	1090	100KHz/0.1V
PIH10D50-R80□	0.8	13.50	4.3	100KHz/0.1V
PIH10D50-1R5□	1.5	10.50	5.8	100KHz/0.1V
PIH10D50-2R2□	2.2	9.25	7.2	100KHz/0.1V
PIH10D50-3R3□	3.3	7.80	10.4	100KHz/0.1V
PIH10D50-4R7□	4.7	6.40	12.3	100KHz/0.1V
PIH10D50-6R8□	6.8	5.40	18	100KHz/0.1V
PIH10D50-8R2□	8.2	4.85	20	100KHz/0.1V
PIH10D50-100□	10.0	4.45	26	100KHz/0.1V
PIH10D50-120□	12.0	4.00	33	100KHz/0.1V
PIH10D50-150□	15.0	3.60	41	100KHz/0.1V
PIH10D50-180□	18.0	3.20	46	100KHz/0.1V
PIH10D50-220□	22.0	2.95	61	100KHz/0.1V
PIH10D50-270□	27.0	2.70	69	100KHz/0.1V
PIH10D50-330□	33.0	2.40	84	100KHz/0.1V
PIH10D50-390□	39.0	2.30	106	100KHz/0.1V
PIH10D50-470□	47.0	2.00	130	100KHz/0.1V
PIH10D50-560□	56.0	1.90	149	100KHz/0.1V
PIH10D50-680□	68.0	1.65	201	100KHz/0.1V
PIH10D50-820□	82.0	1.50	227	100KHz/0.1V
PIH10D50-101□	100.0	1.35	253	100KHz/0.1V
PIH10D50-121□	120.0	1.28	303	100KHz/0.1V
PIH10D50-151□	150.0	1.12	370	100KHz/0.1V
PIH10D50-181□	180.0	1.04	419	100KHz/0.1V
PIH10D50-221□	220.0	0.94	500	100KHz/0.1V
PIH10D50-271□	270.0	0.84	672	100KHz/0.1V
PIH10D50-331□	330.0	0.75	812	100KHz/0.1V
PIH10D50-391□	390.0	0.70	953	100KHz/0.1V
PIH10D50-471□	470.0	0.60	1289	100KHz/0.1V
PIH10D50-561□	560.0	0.54	1430	100KHz/0.1V
PIH10D50-681□	680.0	0.52	1599	100KHz/0.1V
PIH10D50-821□	820.0	0.50	1768	100KHz/0.1V
PIH10D50-102□	1000.0	0.48	1989	100KHz/0.1V

Electrical Characteristics (PIH10D50 TYPE)

Part No.	INDUCTANCE (μH)	IDC (A)	DCR (m Ω) Max	Test frequency
PIH10D60-1R3□	1.3	11.00	6	100KHz/0.1V
PIH10D60-2R2□	2.2	9.00	7	100KHz/0.1V

SMD High Current Power Inductors / PIH TYPE

Electrical Characteristics (PIH10D50 TYPE)

Part No.	INDUCTANCE (μ H)	IDC (A)	DCR (m Ω) Max	Test frequency
PIH10D60-3R3□	3.3	8.00	9	100KHz/0.1V
PIH10D60-4R7□	4.7	6.50	13.5	100KHz/0.1V
PIH10D60-6R8□	6.8	5.50	15	100KHz/0.1V
PIH10D60-8R2□	8.2	5.20	18	100KHz/0.1V
PIH10D60-100□	10.0	4.50	24	100KHz/0.1V
PIH10D60-120□	12.0	4.40	26	100KHz/0.1V
PIH10D60-150□	15.0	3.70	31	100KHz/0.1V
PIH10D60-180□	18.0	3.50	41	100KHz/0.1V
PIH10D60-220□	22.0	3.00	55	100KHz/0.1V
PIH10D60-270□	27.0	2.80	73	100KHz/0.1V
PIH10D60-330□	33.0	2.30	98	100KHz/0.1V
PIH10D60-390□	39.0	1.90	140	100KHz/0.1V
PIH10D60-470□	47.0	1.80	165	100KHz/0.1V
PIH10D60-560□	56.0	1.78	160	100KHz/0.1V
PIH10D60-680□	68.0	1.58	210	100KHz/0.1V
PIH10D60-820□	82.0	1.50	230	100KHz/0.1V
PIH10D60-101□	100.0	1.35	270	100KHz/0.1V
PIH10D60-121□	120.0	1.25	300	100KHz/0.1V
PIH10D60-151□	150.0	1.20	340	100KHz/0.1V
PIH10D60-181□	180.0	1.05	430	100KHz/0.1V
PIH10D60-221□	220.0	1.00	470	100KHz/0.1V
PIH10D60-271□	270.0	0.83	720	100KHz/0.1V
PIH10D60-331□	330.0	0.75	820	100KHz/0.1V
PIH10D60-391□	390.0	0.70	890	100KHz/0.1V
PIH10D60-471□	470.0	0.65	1100	100KHz/0.1V
PIH10D60-561□	560.0	0.62	1240	100KHz/0.1V
PIH10D60-681□	680.0	0.55	1550	100KHz/0.1V
PIH10D60-821□	820.0	0.50	1670	100KHz/0.1V
PIH10D60-102□	1000.0	0.45	2000	100KHz/0.1V

Electrical Characteristics (PIH10D68 TYPE)

Part No.	INDUCTANCE (μ H)	IDC (A)	DCR (m Ω) Max	Test frequency
PIH10D68-1R3□	1.3	12.00	5	100KHz/0.1V
PIH10D68-2R6□	2.6	9.00	5.5	100KHz/0.1V
PIH10D68-3R9□	3.9	7.00	13.5	100KHz/0.1V
PIH10D68-6R8□	6.8	6.50	17.6	100KHz/0.1V
PIH10D68-8R2□	8.3	5.30	21	100KHz/0.1V
PIH10D68-100□	10.0	4.90	28	100KHz/0.1V
PIH10D68-120□	12.0	4.40	36	100KHz/0.1V
PIH10D68-150□	15.0	3.90	42.5	100KHz/0.1V
PIH10D68-180□	18.0	3.50	50	100KHz/0.1V
PIH10D68-220□	22.0	3.10	65	100KHz/0.1V

SMD High Current Power Inductors / PIH TYPE

Electrical Characteristics (PIH10D68 TYPE)

Part No.	INDUCTANCE (μ H)	IDC (A)	DCR (m Ω) Max	Test frequency
PIH10D68-270□	27.0	2.55	90	100KHz/0.1V
PIH10D68-330□	33.0	2.35	100	100KHz/0.1V
PIH10D68-390□	39.0	1.90	150	100KHz/0.1V
PIH10D68-470□	47.0	1.82	155	100KHz/0.1V
PIH10D68-560□	56.0	1.78	170	100KHz/0.1V
PIH10D68-680□	68.0	1.58	210	100KHz/0.1V
PIH10D68-820□	82.0	1.50	220	100KHz/0.1V
PIH10D68-101□	100.0	1.40	250	100KHz/0.1V
PIH10D68-121□	120.0	1.30	320	100KHz/0.1V
PIH10D68-151□	150.0	1.20	345	100KHz/0.1V
PIH10D68-181□	180.0	1.10	420	100KHz/0.1V
PIH10D68-221□	220.0	1.00	460	100KHz/0.1V
PIH10D68-271□	270.0	0.90	620	100KHz/0.1V
PIH10D68-331□	330.0	0.85	670	100KHz/0.1V
PIH10D68-391□	390.0	0.78	850	100KHz/0.1V
PIH10D68-471□	470.0	0.73	1100	100KHz/0.1V
PIH10D68-561□	560.0	0.67	1200	100KHz/0.1V
PIH10D68-681□	680.0	0.62	1460	100KHz/0.1V
PIH10D68-821□	820.0	0.55	1750	100KHz/0.1V
PIH10D68-102□	1000.0	0.52	2050	100KHz/0.1V

NOTE:

1. Inductance is measured by LCR-meter 4284A(HP) or equivalent.
2. DC Resistance is measured by HP4338B Milliohms Meter or equivalent.
3. Rated current is measured by LCR-meter 3260B(WK) & DC Bias 3265B(WK).
4. Rated current: Value obtained when current flows and the temperature has risen to 40°C or when DC current flows and the initial value of inductance has fallen by 35%, whichever is smaller.
5. Operating temperature -55°C ~ +125°C.
6. All test data is referenced to 25°C ambient.
7. □Tolerance : J=5% ; K=10% ; M=20% ; N=30%