

Total solder points: 234

Difficulty level:

beginner 1 2 3 4 5 *advanced*

velleman-kit HIGH-Q 

BASE UNIT for HOME MODULAR LIGHT SYSTEM

K8006

Features :

- Create your own domestic modular light control system
- For use with optional plug-in dimmer module (K8007) and plug-in timer module (K8008)
- Bus system holds up to five plug-in units
- Optically insulated push button inputs
- Can be controlled with open collector circuits (ex. K8000 computer interface card or with IR remote control receiver K6711)
- Local control pushbuttons included
- LED power and mains indicator
- LED operation indicator for each channel
- Low-voltage control circuit for extra safety
- Each plug-in slot is fused
- Includes 10 LED's for pushbutton illumination
- A custom enclosure for rail mounting is available (B8006)

Specifications :

- Five separate channels
- Maximum output : 2.5A per channel (fuse protected)
- Push button control current: 150mA
- Open collector control current: 35mA DC
- Power supply: 24VAC / 300mA
- Supply voltage for modules: 110V to 240VAC
- PCB dimensions: 107 x 160 x 70mm/ 4.2"x6.3"x2.8"

modifications reserved



VELLEMAN COMPONENTS

Legen Heirweg 33

9890 Gavere

Belgium

<http://www.velleman.be>

1. Assembly (Skipping this can lead to troubles !)

Ok, so we have your attention. These hints will help you to make this project successful. Read them carefully.

1.1 Make sure you have the right tools:

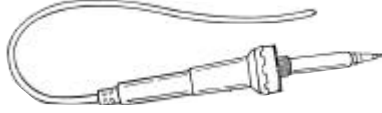
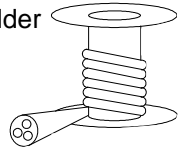
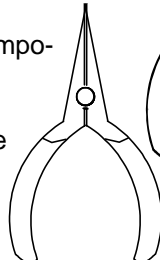
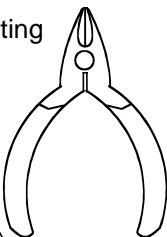
- A good quality soldering iron (25-40W) with a small tip. 
- Wipe it often on a wet sponge or cloth, to keep it clean; then apply solder to the tip, to give it a wet look. This is called 'thinning' and will protect the tip, and enables you to make good connections. When solder rolls off the tip, it needs cleaning.
- Thin raisin-core solder. Do not use any flux or grease. 
- A diagonal cutter to trim excess wires. To avoid injury when cutting excess leads, hold the lead so they cannot fly towards the eyes.
- Needle nose pliers, for bending leads, or to hold components in place. 
- Small blade and phillips screwdrivers. A basic range is fine. 

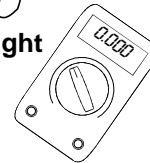

For some projects, a basic multi-meter is required, or might be handy

**1.2 Assembly Hints :**

- ⇒ Make sure the skill level matches your experience, to avoid disappointments.
- ⇒ Follow the instructions carefully. Read and understand the entire step before you perform each operation.
- ⇒ Perform the assembly in the correct order as stated in this manual
- ⇒ Position all parts on the PCB (Printed Circuit Board) as shown on the drawings.
- ⇒ Values on the circuit diagram are subject to changes.
- ⇒ Values in this assembly guide are correct*
- ⇒ Use the check-boxes to mark your progress.
- ⇒ Please read the included information on safety and customer service

* Typographical inaccuracies excluded. Always look for possible last minute manual updates, indicated as 'NOTE' on a separate leaflet.

1.3 Soldering Hints :

1- Mount the component against the PCB surface and carefully solder the leads

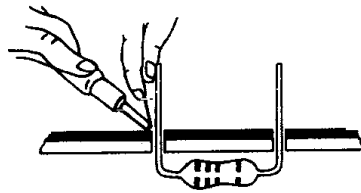

2- Make sure the solder joints are cone-shaped and shiny

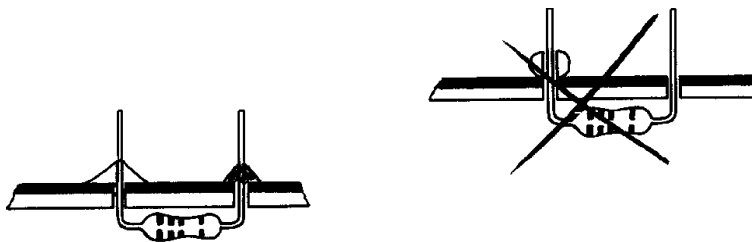

3- Trim excess leads as close as possible to the solder joint

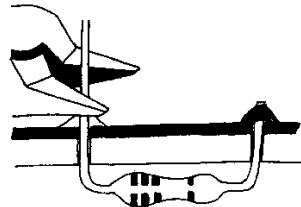

AXIAL COMPONENTS ARE TAPED IN THE CORRECT MOUNTING SEQUENCE !

REMOVE THEM FROM THE TAPE ONE AT A TIME !

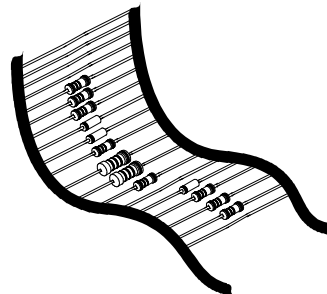

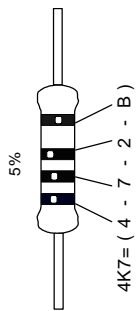
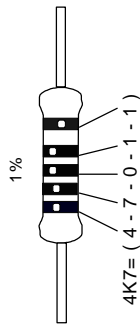
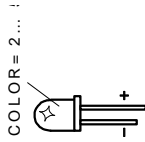

	I	P	E	SF	S	DK	N	D	GB	F	NL
C O D E	CODICE COLORE	CODIGO DE CORES	CODIGO DE COL- ORES	VÄRI KOODI	FÄRG SCHEMA	FARVE- KODE	FARGE- KODE	FARB KODE	COLOUR CODE	CODIFI- CATION DES COU-	KLEURC KODE O D E
0	Nero	Preto	Negro	Musta	Svart	Sort	Sort	Schwarz	Black	Noir	Zwart
1	Marrone	Castanho	Marrón	Ruskea	Brun	Brun	Brun	Braun	Brown	Brun	Bruin
2	Rosso	Encar- nado	Rojo	Punainen	Röd	Rød	Rød	Rot	Red	Rouge	Rood
3	Aran- ciato	Laranja	Naran- jado	Oranssi	Orange	Orange	Orange	Orange	Orange	Orange	Oranje
4	Giallo	Amarelo	Amarillo	Keltainen	Gul	Gul	Gul	Gelb	Yellow	Jaune	Geel
5	Verde	Verde	Verde	Vihreä	Grön	Grøn	Grønn	Grün	Green	Vert	Groen
6	Blu	Azul	Azul	Sininen	Blå	Blå	Blå	Blau	Blue	Bleu	Blauw
7	Viola	Violeta	Morado	Purppura	Lila	Violet	Violet	Violet	Purple	Violet	Paars
8	Grigio	Cinzento	Gris	Harmaa	Grå	Grå	Grå	Grau	Grey	Gris	Grijs
9	Bianco	Branco	Blanco	Valkoinen	Vit	Hvid	Hvidt	Weiss	White	Blanc	Wit
A	Argento	Prateado	Plata	Hopea	Silver	Sølv	Sølv	Silber	Silver	Argent	Zilver
B	Oro	Dourado	Oro	Kulta	Guld	Guld	Guldi	Gold	Gold	Or	Goud

1. Diodes (check the polarity)

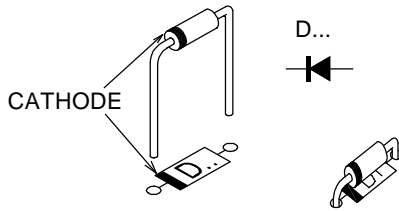

- D1 : 1N4148
- D2 : 1N4148
- D3 : 1N4148
- D4 : 1N4148
- D5 : 1N4148
- D6 : 1N4148
- D7 : 1N4007
- D8 : 1N4007
- D9 : 1N4007
- D10 : 1N4007
- D11 : 1N4007
- D12 : 1N4007
- D13 : 1N4007
- D14 : 1N4007
- D15 : 1N4007
- D16 : 1N4007
- D17 : 1N4007

2. 1/4W Resistor

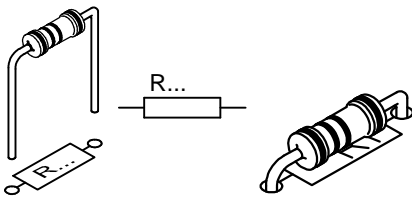

- R1: 3K3 (3-3-2-B)

3. 1/2W Resistors

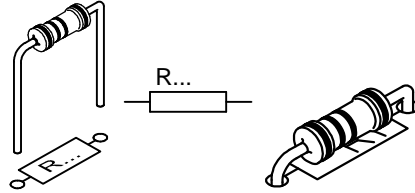

- R2: 180 (1-8-1-B-9)
- R3: 180 (1-8-1-B-9)
- R4: 2K2 (2-2-2-B-9)
- R5: 2K2 (2-2-2-B-9)
- R6: 180 (1-8-1-B-9)
- R7: 180 (1-8-1-B-9)
- R8: 2K2 (2-2-2-B-9)
- R9: 2K2 (2-2-2-B-9)
- R10: 180 (1-8-1-B-9)
- R11: 180 (1-8-1-B-9)
- R12: 2K2 (2-2-2-B-9)
- R13: 2K2 (2-2-2-B-9)
- R14: 180 (1-8-1-B-9)
- R15: 180 (1-8-1-B-9)
- R16: 2K2 (2-2-2-B-9)
- R17: 2K2 (2-2-2-B-9)
- R18: 180 (1-8-1-B-9)
- R19: 180 (1-8-1-B-9)
- R20: 2K2 (2-2-2-B-9)
- R21: 2K2 (2-2-2-B-9)
- R22: 100K (1-0-4-B-9)
- R23: 100K (1-0-4-B-9)

4. Zener diode (check the polarity)

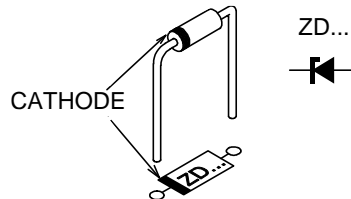

- ZD1 : 47V/1.3W
- ZD2 : 47V/1.3W

5. Pushbutton

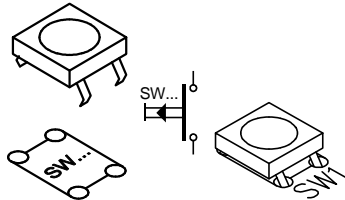

- SW1
- SW2
- SW3
- SW4
- SW5

6. IC sockets (check the position)

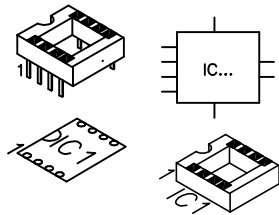

- IC1 : 6P
- IC2 : 6P
- IC3 : 6P
- IC4 : 6P
- IC5 : 6P

7. LEDs (Watch the polarity!)

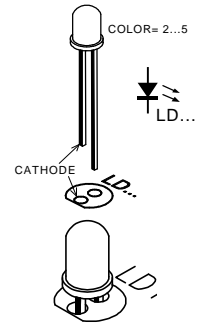

- LD1 : 3mm RED (2)
- LD2 : 3mm RED (2)
- LD3 : 3mm RED (2)
- LD4 : 3mm RED (2)
- LD5 : 3mm RED (2)
- LD6 : 3mm RED (2)
- LD7 : 3mm RED (2)

8. PCB Edge Connectors (Watch the orientation!)

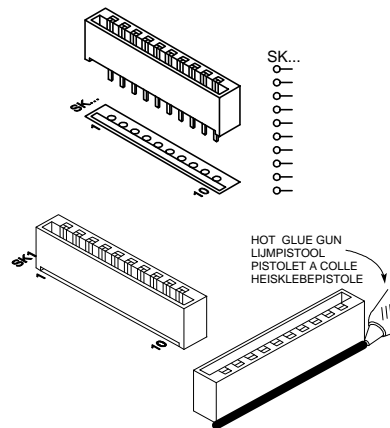

- SK1: 10 POLE
- SK2: 10 POLE
- SK3: 10 POLE
- SK4: 10 POLE
- SK5: 10 POLE

9. PC Terminal blocks
(Slide the terminal blocks, one into each other)

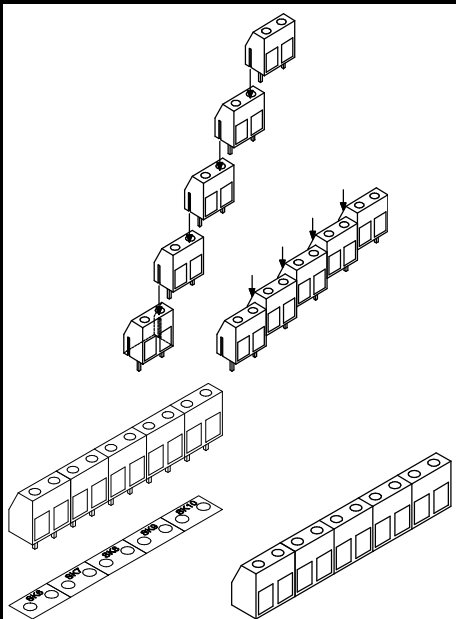

- SK6 to SK10 : 2P+2P+2P+2P+2P

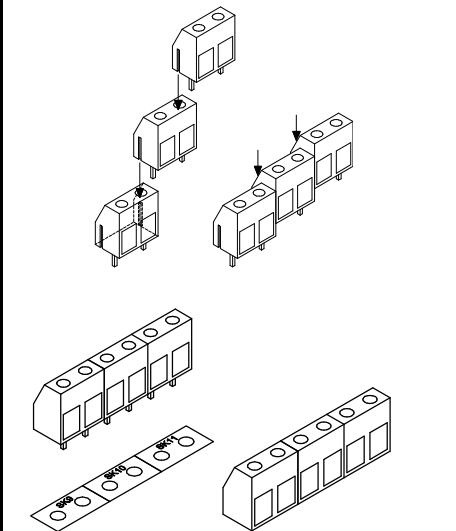

- SK11 to SK13 : 2P+2P+2P

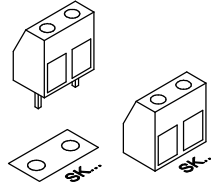

- SK14: 2-POLE (wide)
- SK15: 2-POLE (wide)
- SK16: 2-POLE (wide)
- SK17: 2-POLE (wide)
- SK18: 2-POLE (wide)
- SK19: 2-POLE (wide)
- SK20: 2-POLE (wide)

10. Fuse Holder + Fuse

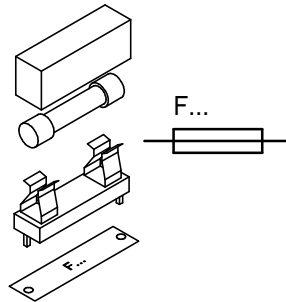

- F1: 2.5A SLOW
- F2: 2.5A SLOW
- F3: 2.5A SLOW
- F4: 2.5A SLOW
- F5: 2.5A SLOW

**11. Electrolytic capacitors.
Check the polarity !**

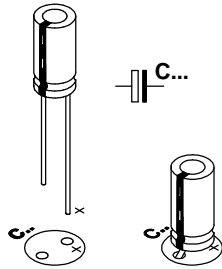

- C1: 22 μ F/50V
- C2: 22 μ F/50V
- C3: 22 μ F/50V
- C4: 22 μ F/50V
- C5: 22 μ F/50V

12. Modular Jack

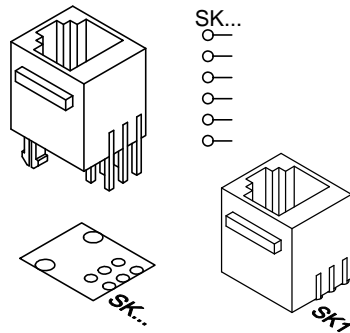

- SK21: 6-POLE

**13. Insert the OPTO Coupler into
the socket (Watch the position of
the notch!)**

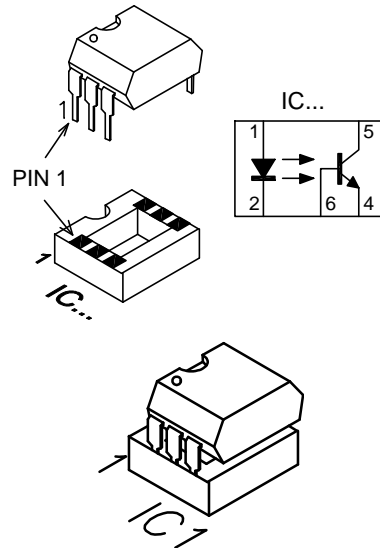

- IC1: 4N27, TIL111 or eq.
- IC2: 4N27, TIL111 or eq.
- IC3: 4N27, TIL111 or eq.
- IC4: 4N27, TIL111 or eq.
- IC5: 4N27, TIL111 or eq.

14. Testing the Unit



CAUTION: MOST PARTS OF THE CIRCUIT CARRY DANGEROUS VOLTAGES (MAINS) ! OBSERVE ALL SAFETY REQUIREMENTS THAT MIGHT APPLY !

First, make sure to apply an extra layer of solder on all thinned PCB tracks because these have to handle high currents.

Connect a light bulb rated for the wall outlet voltage (mains) to **LOAD 1**. Insert a dimmer module (K8007) or timer module (K8008) into the first slot (mind the direction, the components must point to the left).

Connect a 24VAC/300mA source (e.g. transformer) to the **24VAC** connector. LD6 will light.

Connect the 110-240V mains to the SUPPLY **Neutral** and **Live** connector. LD7 will light.

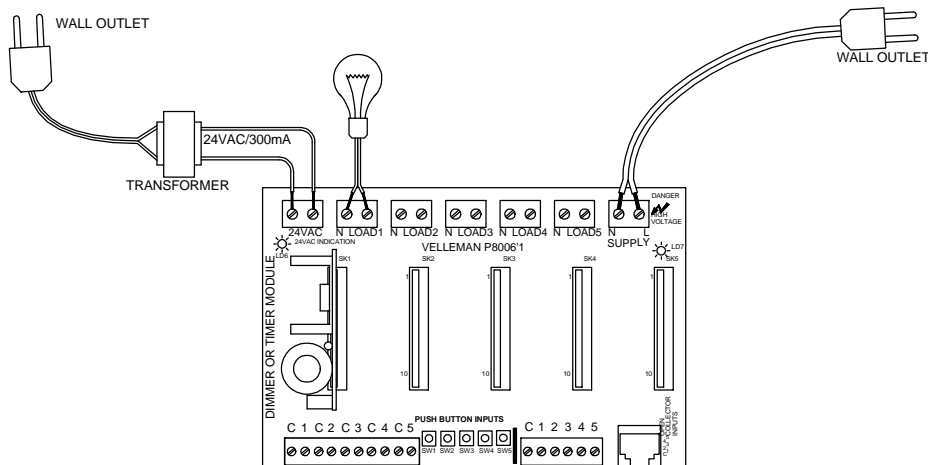

Push button SW1. The module will be activated, and the light bulb will light. For dimmer/timer module operation details, please check their manuals. All remaining slots must be tested in the same way. Disconnect the mains when removing modules or wiring.

15. Final Connection

Choose a suitable location for the unit. Probably, the best location is near the fuse box. An optional enclosure (B8006) is available, for safe installation of the unit on a DIN rail. Whatever enclosure you use, make sure to provide sufficient airflow, as the dimmer modules might run hot during use. If you choose the optional B8006 enclosure, drill a number of ventilation holes in the top and bottom part of the cover lid.

The drawing below shows a connection example.

Make sure your wiring complies with the local safety requirements. If doubt, consult a licensed technician !

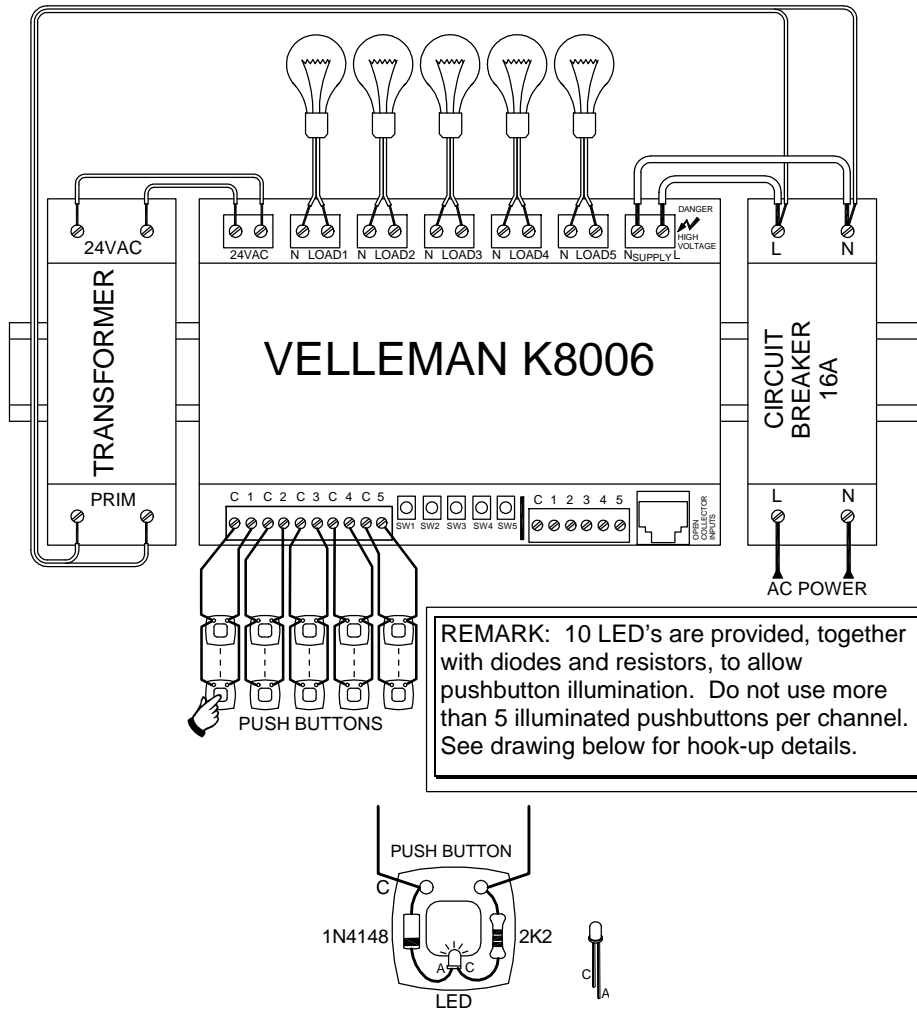

16. Interfacing with open collector outputs

The drawing below shows a connection example with open collector outputs (e.g. K8000 computer interface board, or K6711 remote control receiver). The open collector inputs are also available via modular connector SK19, which allows easy and fast connection to a control circuit.

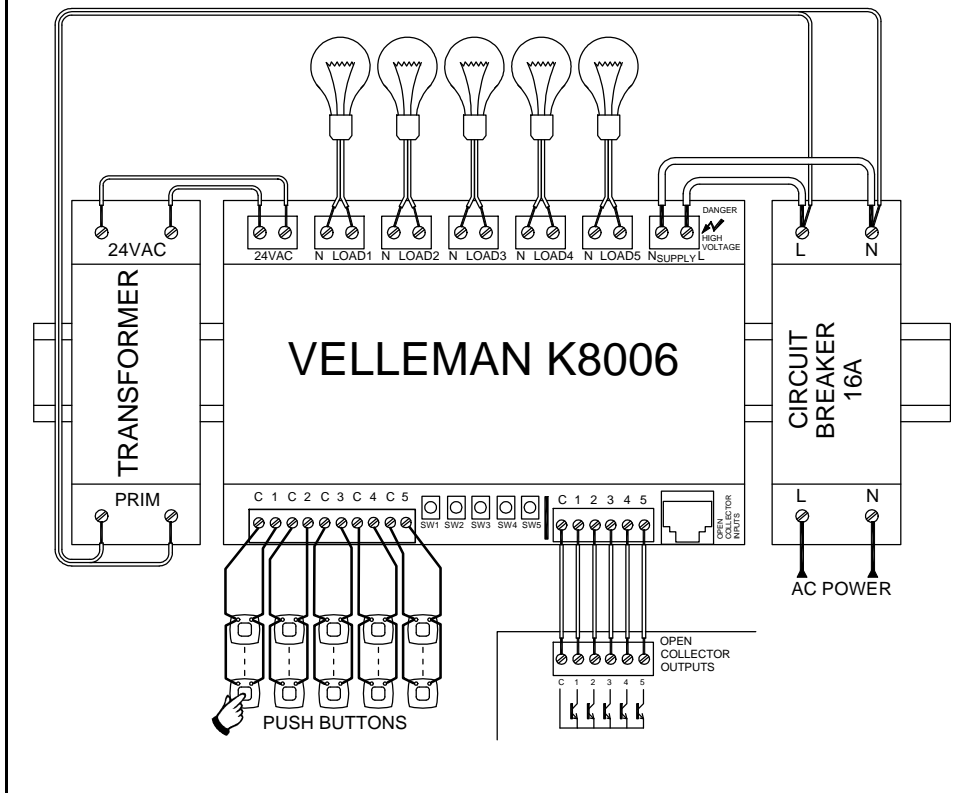

17. PCB Layout

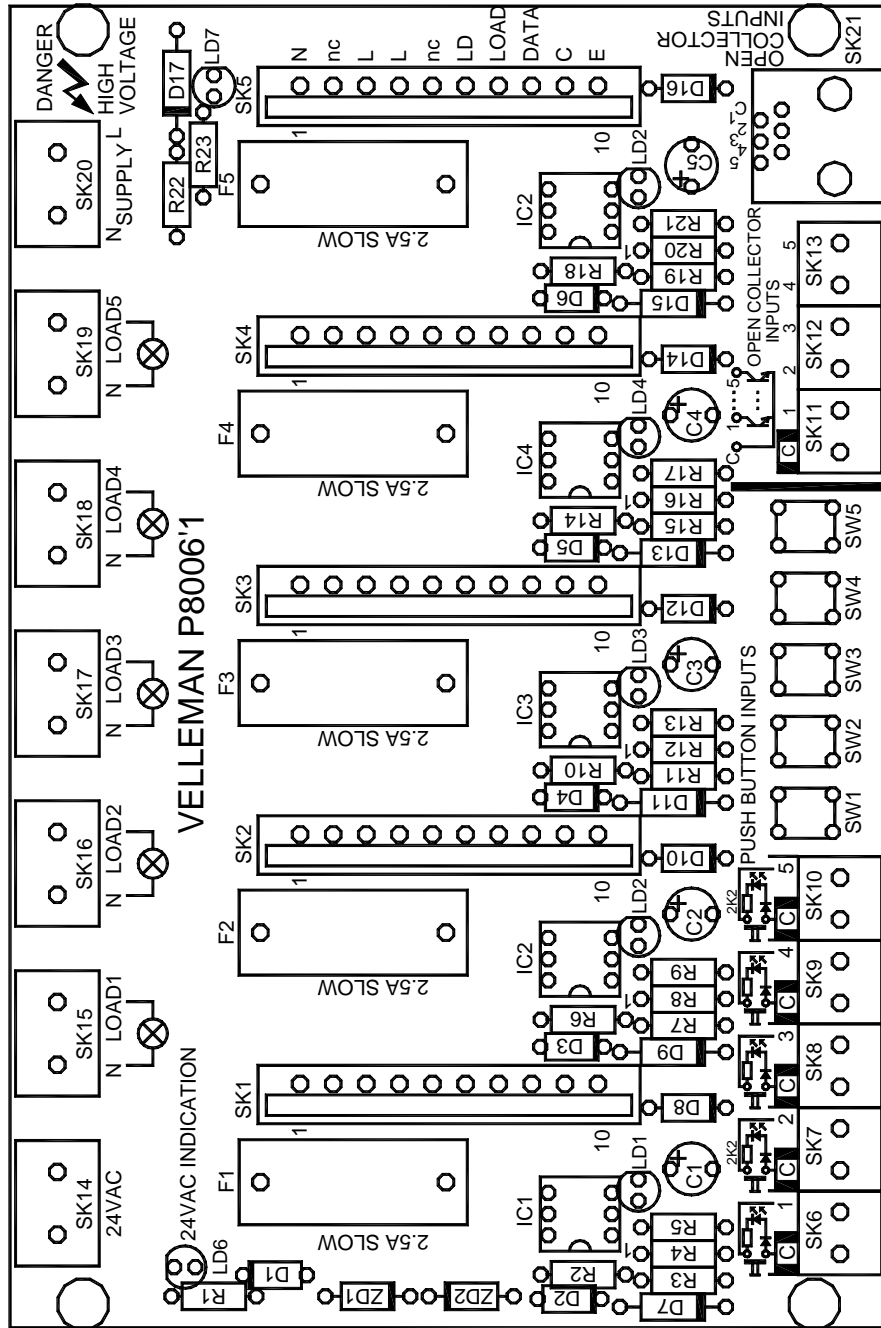

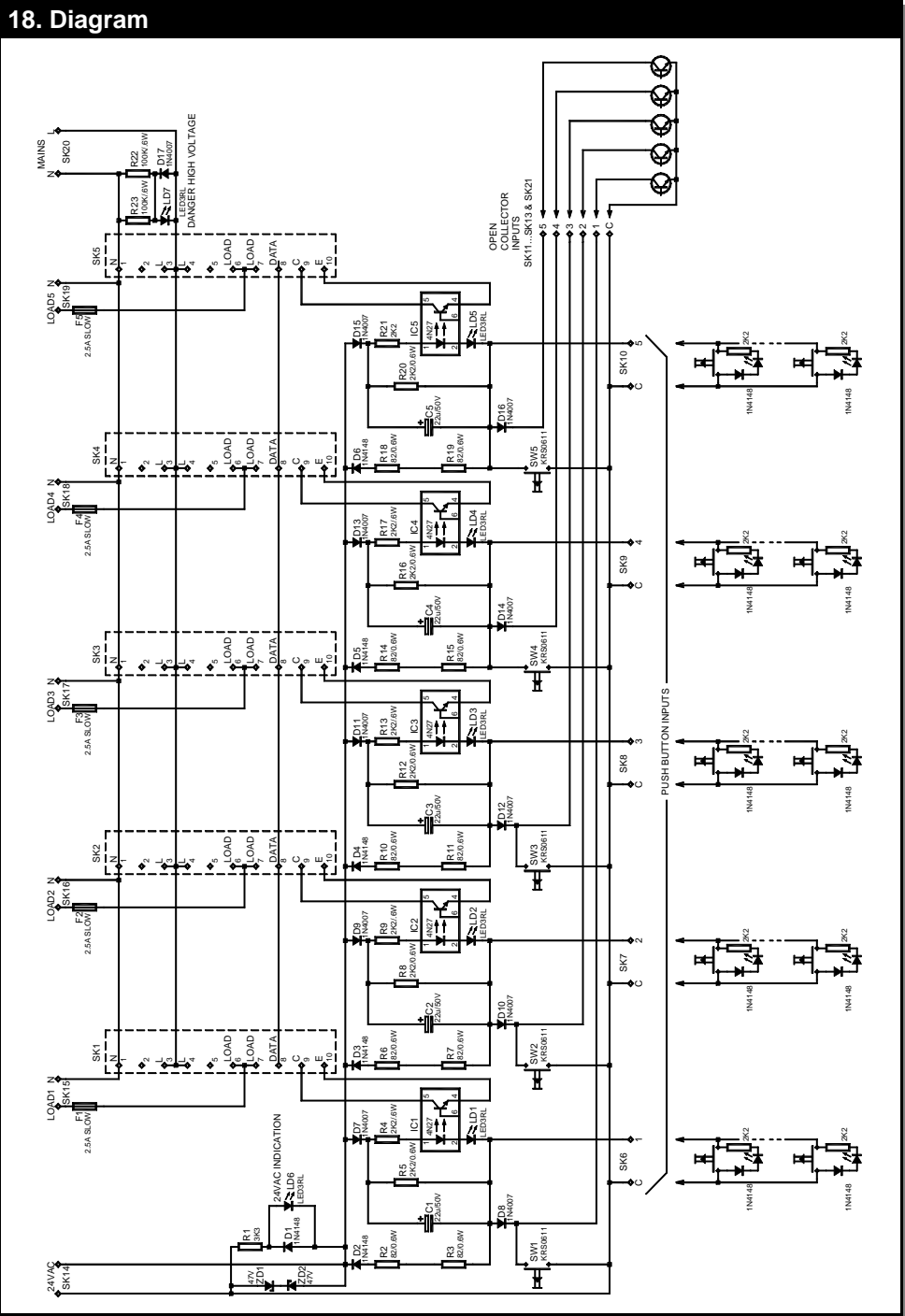

velleman

VELLEMAN Components
Legen Heirweg 33
9890 Gavere
Belgium Europe
Info ? : <http://www.velleman.be>

Modifications and typographical errors reserved
© Velleman
H8006IP - 2001 - ED2