

Key Features and Performance

- 17GHz - 27GHz Bandwidth
- 22 dB Typical Gain
- 37 dBm Typical OTOI
- 29 dBm Typical P1dB
- Vd = 7V, Id = 760mA (Id = 830mA @ P1dB)
- Package Dimensions: 5.0 x 5.0 x 1.10 mm

Measured Performance

Vd = 7V, Id = 760mA

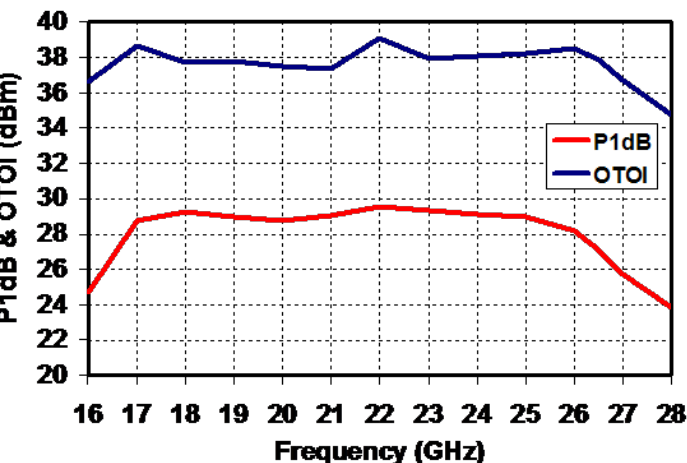
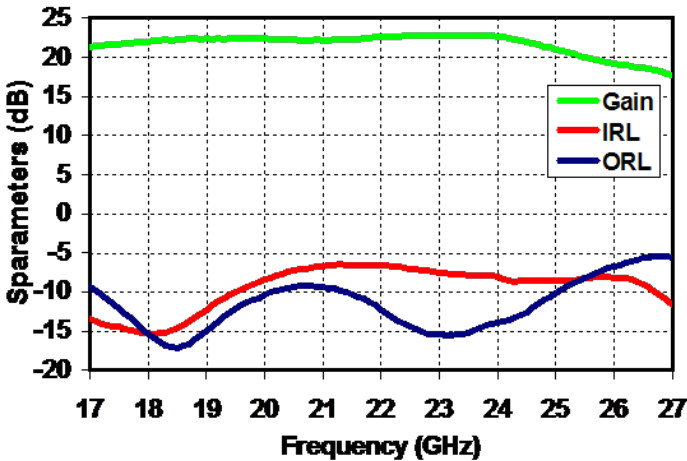

Primary Applications

- Point-to-Point Radio
- K-Band Sat Com
- Point-to-Multipoint Communications

Product Description

The TriQuint TGA4525-SM is a packaged high power amplifier for K-Band applications. The part is designed using TriQuint’s power pHEMT production process.

The TGA4525-SM provides a nominal 29dBm output power at 1dB gain compression with a small signal gain of 22dB.

The part is ideally suited for low cost emerging markets such as K-Band satellite communications, point-to-point & point-to-multipoint communications.

Evaluation boards are available upon request.

Lead-Free & RoHS compliant.

Datasheet subject to change without notice

TABLE I
ABSOLUTE MAXIMUM RATINGS 1/

Symbol	Parameter	Value	Notes
V _d	Drain Supply Voltage	8 V	
I _d	Drain Supply Current (Quiescent)	1100 mA	
V _g	Gate Voltage Range	-5 to 0 V	
I _g	Gate Supply Current	28 mA	
P _{IN}	Input Continuous Wave Power	26 dBm	
P _D	Power Dissipation	8.8 W	
T _{channel}	Channel Temperature	200 °C	<u>2/</u>
	Mounting Temperature (10 seconds)	260 °C	
	Storage Temperature	-65 to 150 °C	

1/ These ratings represent the maximum operable values for this device. Stresses beyond those listed under “Absolute Maximum Ratings” may cause permanent damage to the device and / or affect device lifetime. These are stress ratings only, and functional operation of the device at these conditions is not implied.

2/ Combinations of supply voltage, supply current, input power, and output power shall not exceed P_D.

TABLE II
RF CHARACTERIZATION TABLE
($T_A = 25^\circ\text{C}$, Nominal)
($V_d = 7\text{V}$, $I_d = 760\text{mA} \pm 5\%$)

Symbol	Parameter	Test Conditions	Typ	Units
Gain	Small Signal Gain	F = 17 – 27 GHz	22	dB
IRL	Input Return Loss	F = 17 – 27 GHz	-8	dB
ORL	Output Return Loss	F = 17 – 27 GHz	-10	dB
P1dB	Output Power @ 1dB Gain Compression	F = 17 – 27 GHz	29	dBm
Psat	Saturated Power	F = 17 – 27 GHz	31	dBm
OTOI	Output Third Order Intercept @ Pin = -10dBm	F = 17 – 27 GHz	37	dBm
	Small Signal Gain Temperature Coefficient	F = 17 – 27 GHz	0.04	dB/ ^o C

**TABLE III
THERMAL INFORMATION**

Parameter	Test Conditions	Tchannel (°C)	θ_{JC} (°C/W)	Tm (hrs)
θ_{JC} Thermal Resistance (Channel to Backside of package)	Vd = 7V Id = 760mA PD = 5.3W T _{BASE} = 70 °C	150	15.1	1E+6

Note: Thermal transfer is conducted through the bottom of the TGA4525-SM package into the motherboard. The motherboard must be designed to assure adequate thermal transfer to the base plate.

Median Lifetime (Tm) vs. Channel Temperature

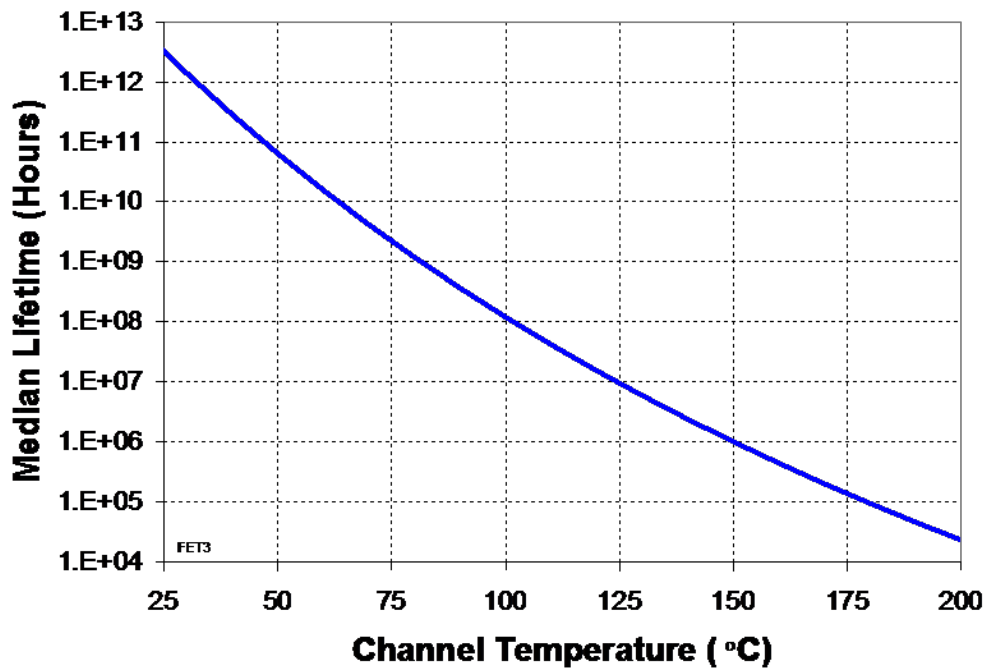

Measured Performance

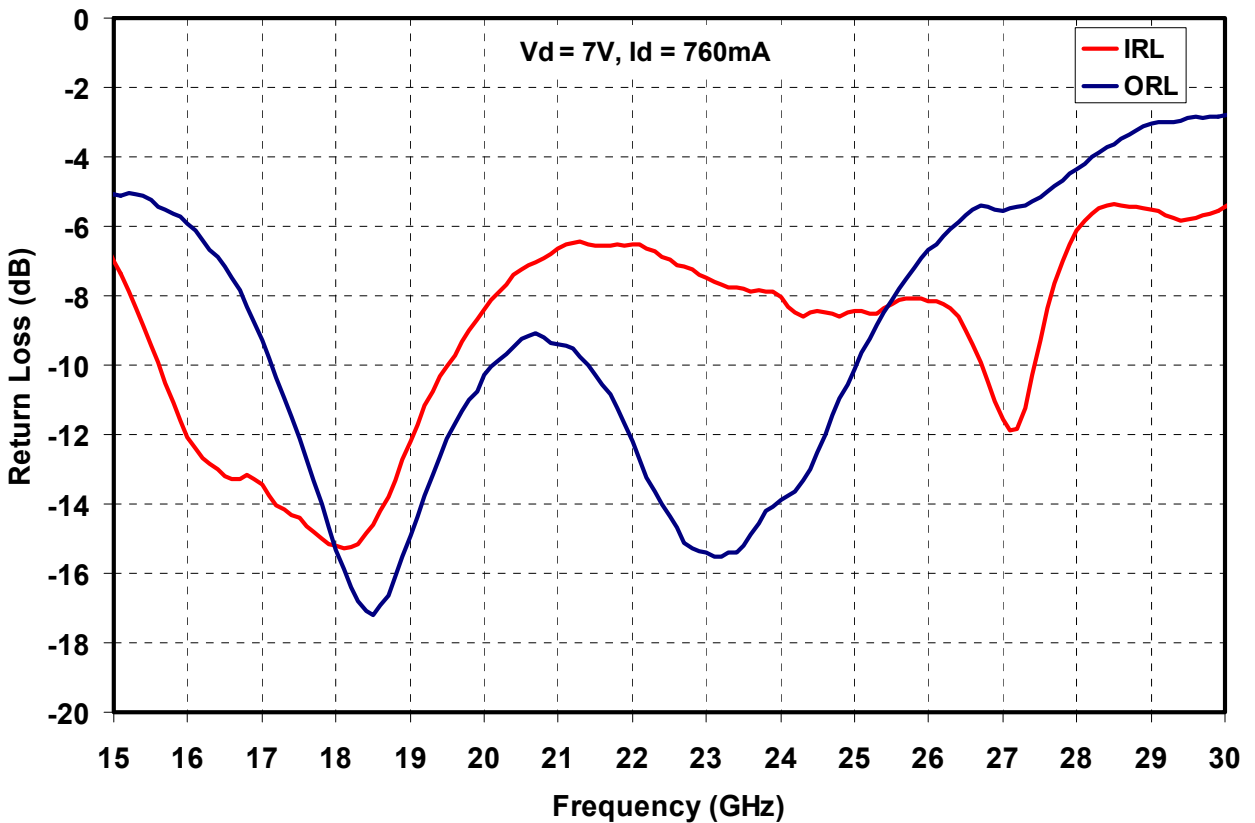
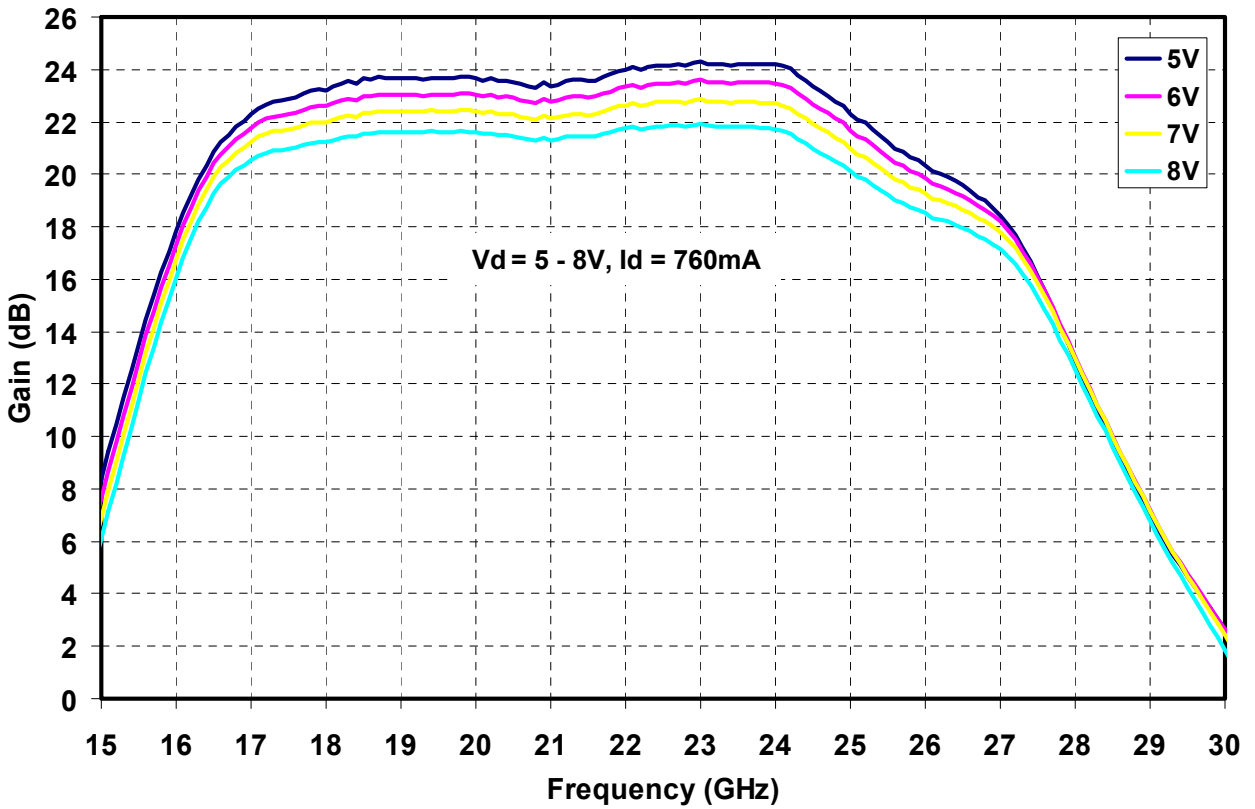

Measured Performance

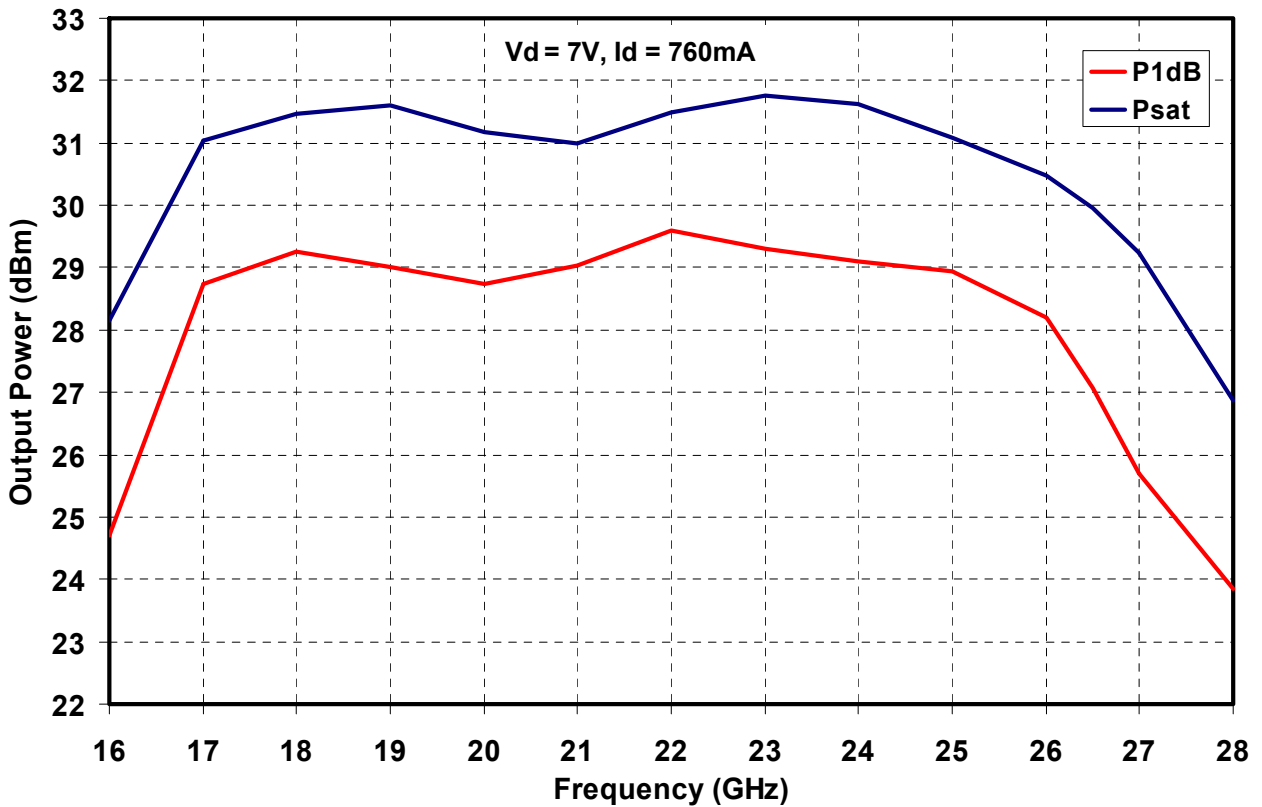
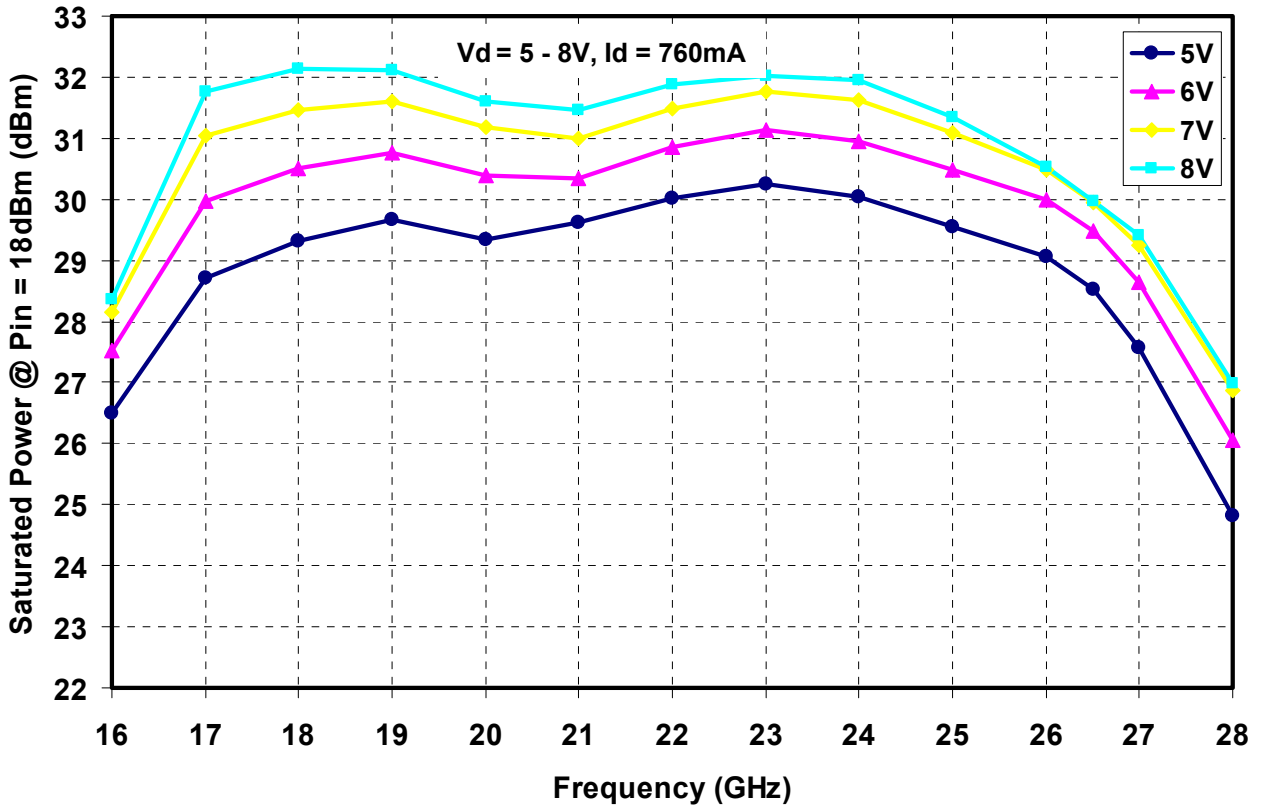

Measured Performance

TGA4525-SM

Vd = 7V, Id = 760mA

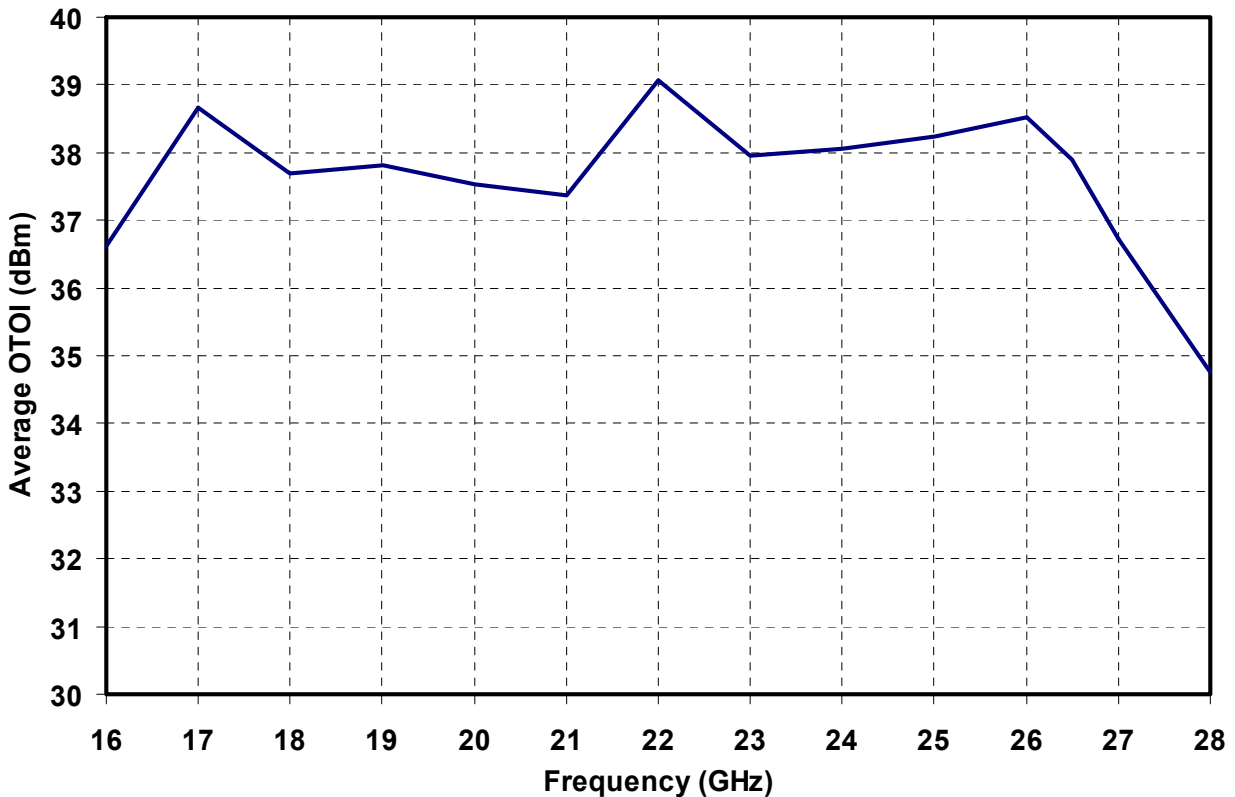
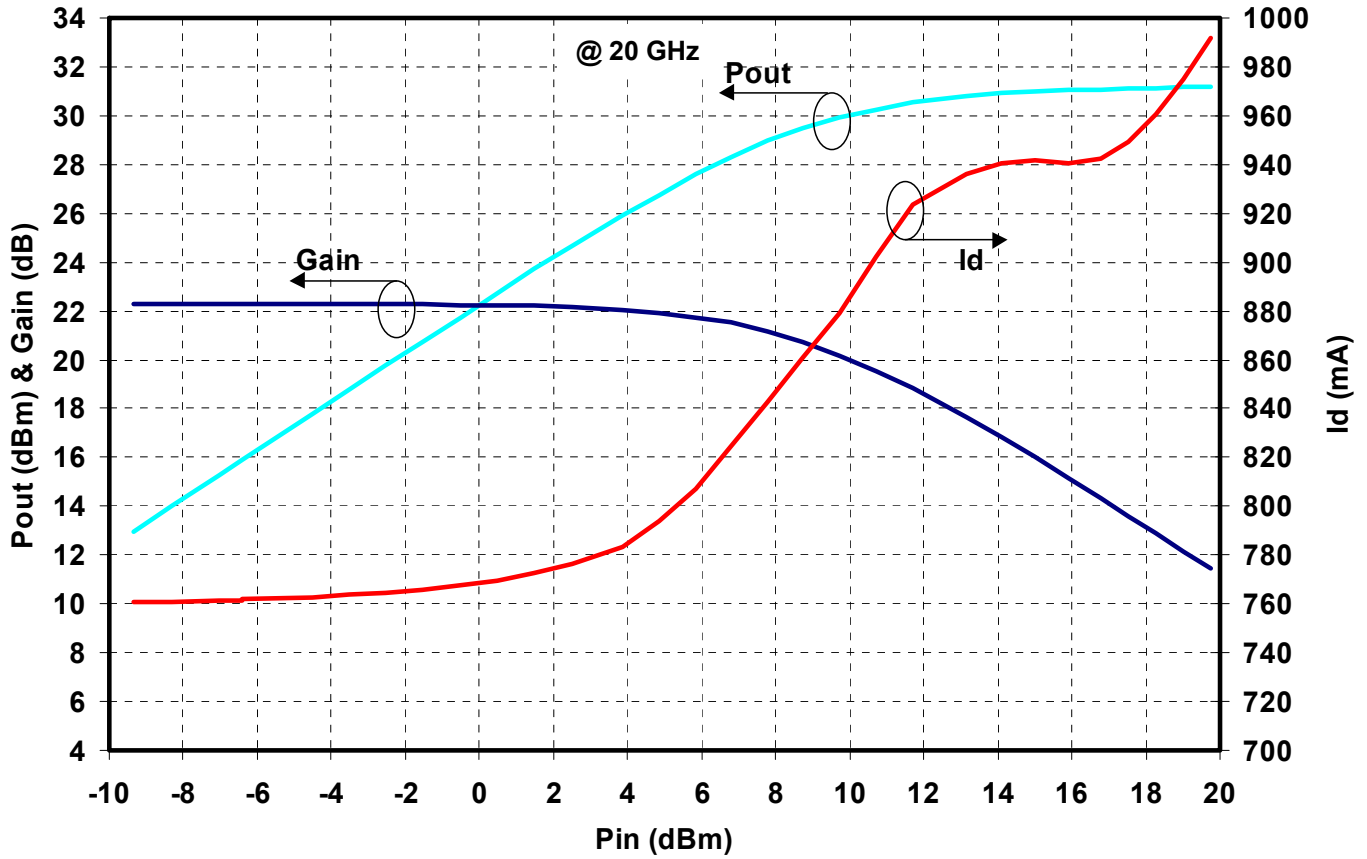

Measured Performance

TGA4525-SM

Vd = 7V, Id = 760mA

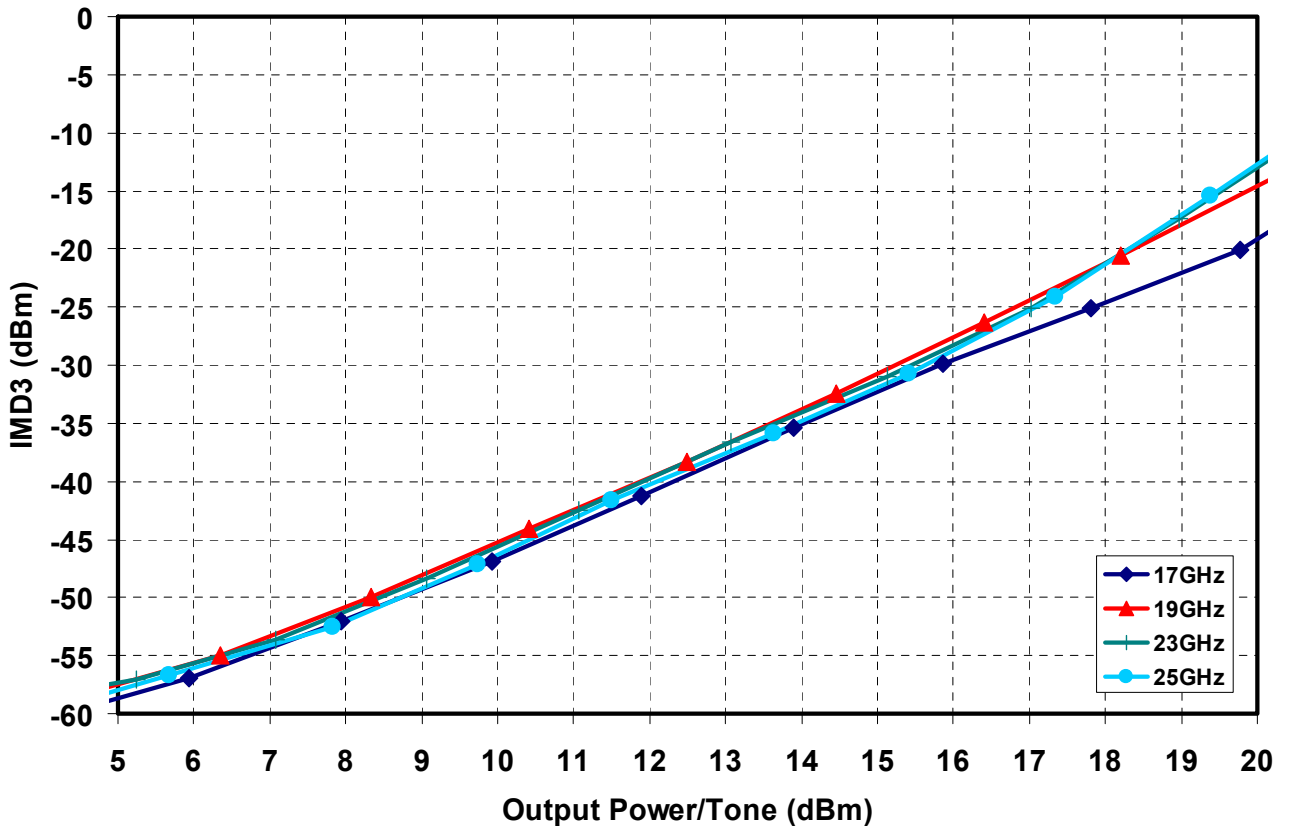
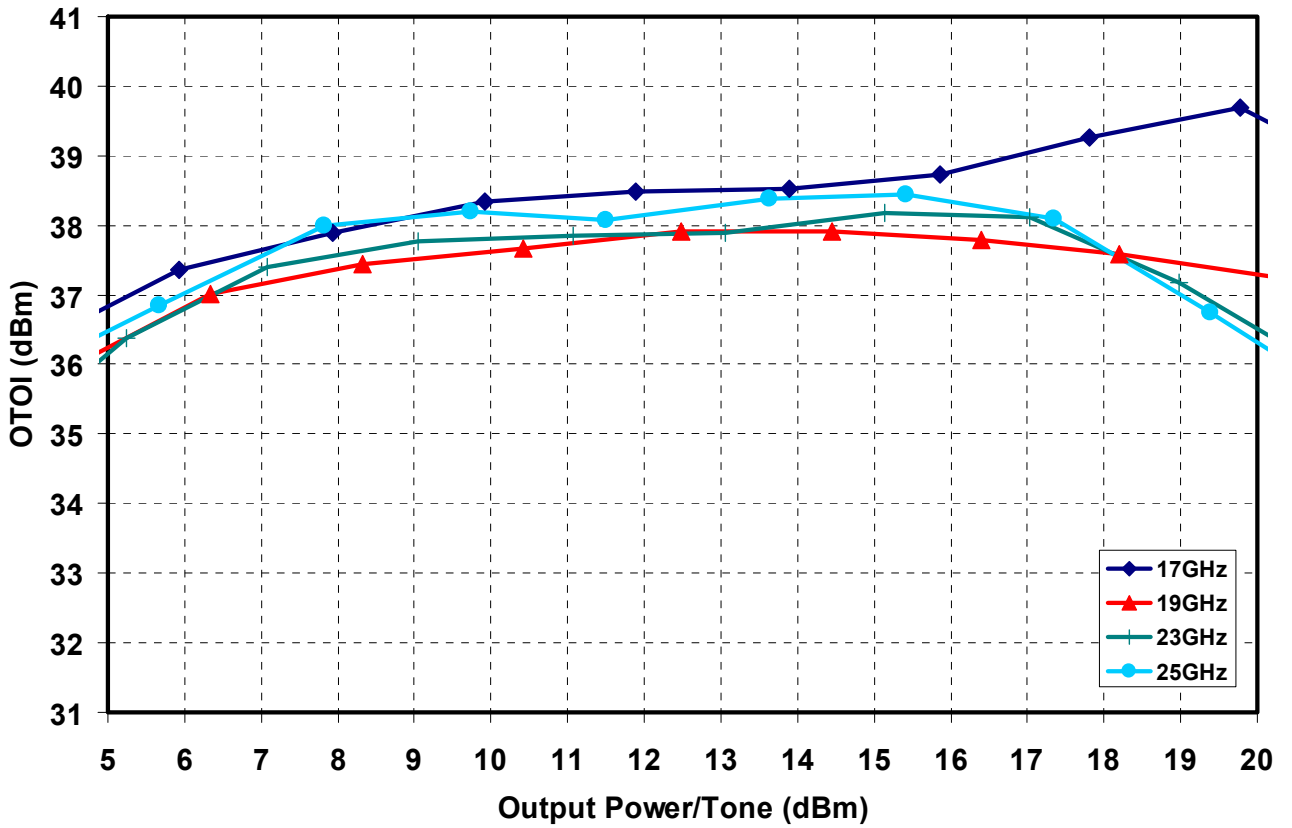

Package Pinout

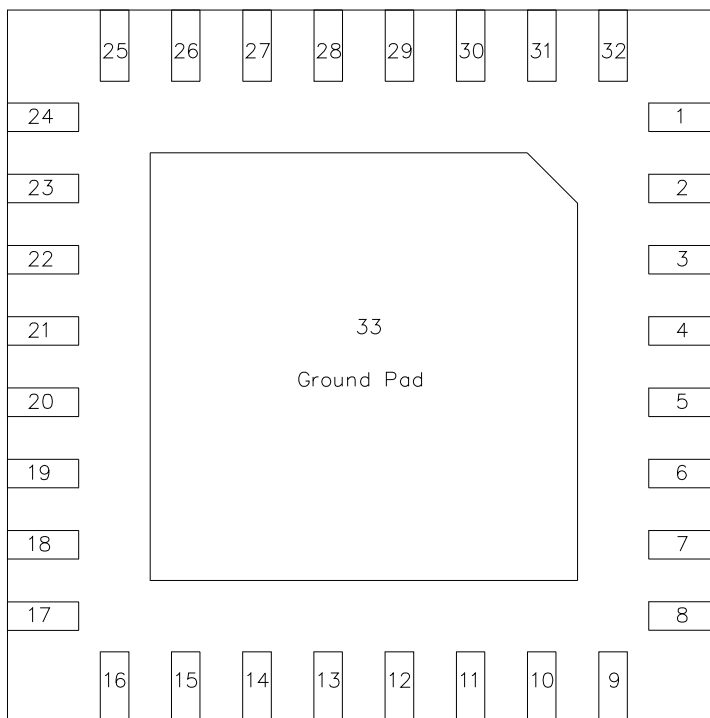

Bottom View

Description	Pin Number
RF Input	4
RF Output	21
Vd	14, 26
Vg	10, 30
Ground	1, 8, 9, 16, 17, 24, 25, 32, 33*
N/C	2, 3, 5, 6, 7, 11, 12, 13, 15, 18, 19, 20, 22, 23, 27, 28, 29, 31

* Center pad is used for Ground as well as heat dissipation of the part.

Mechanical Drawing

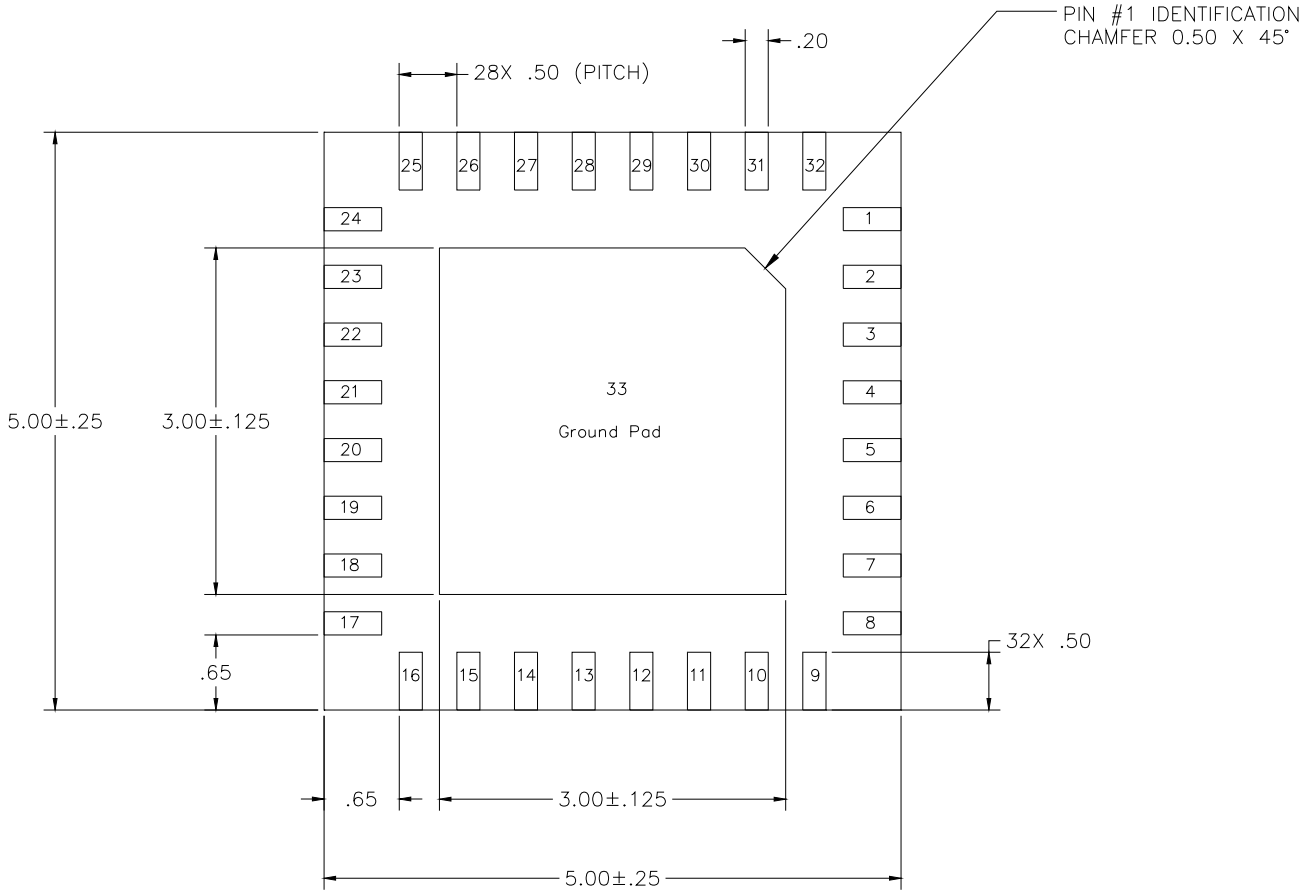

Bottom View

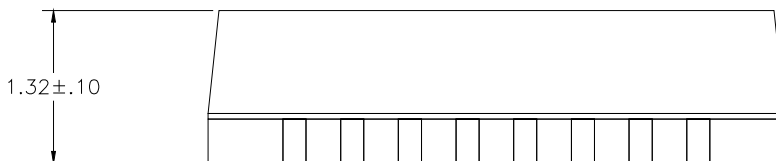

Units: mm

Tolerances: ± 0.076 unless specified

Characterization Board

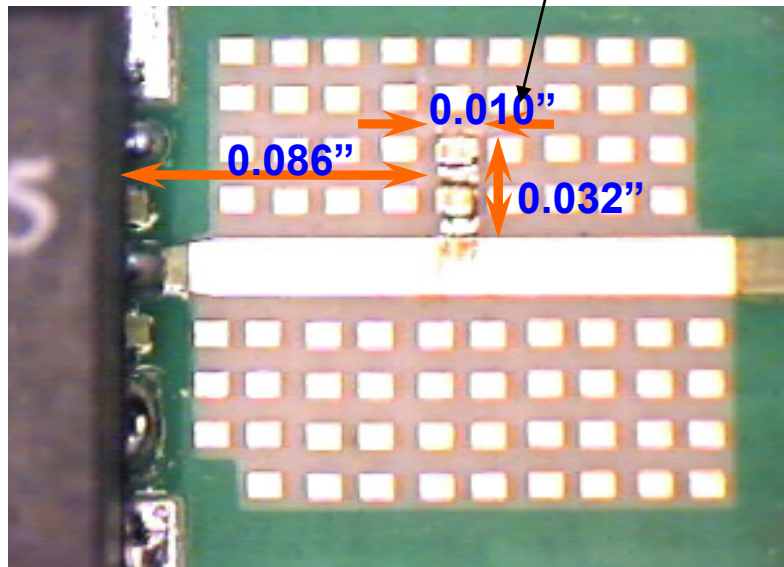
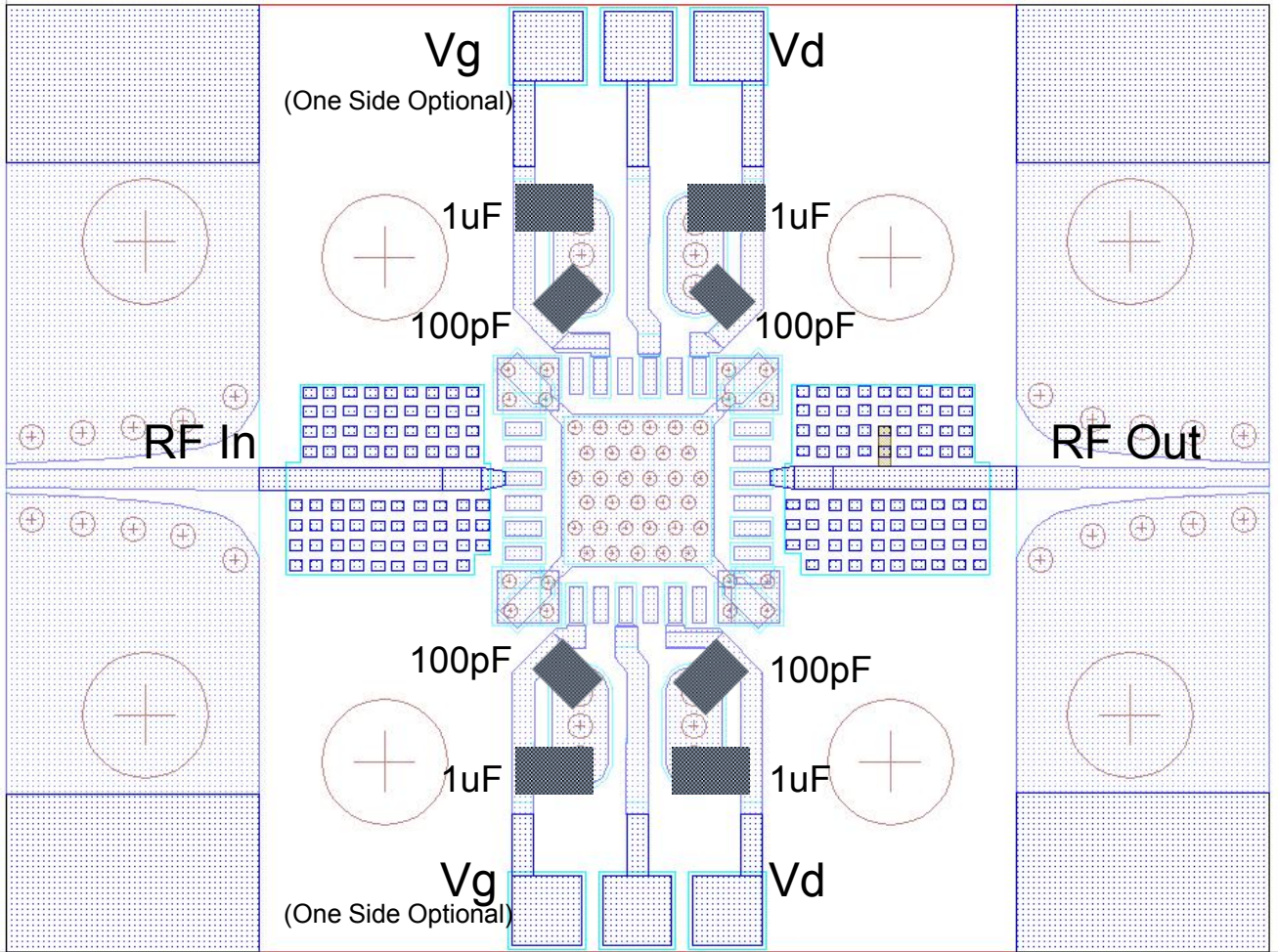

Application Circuit

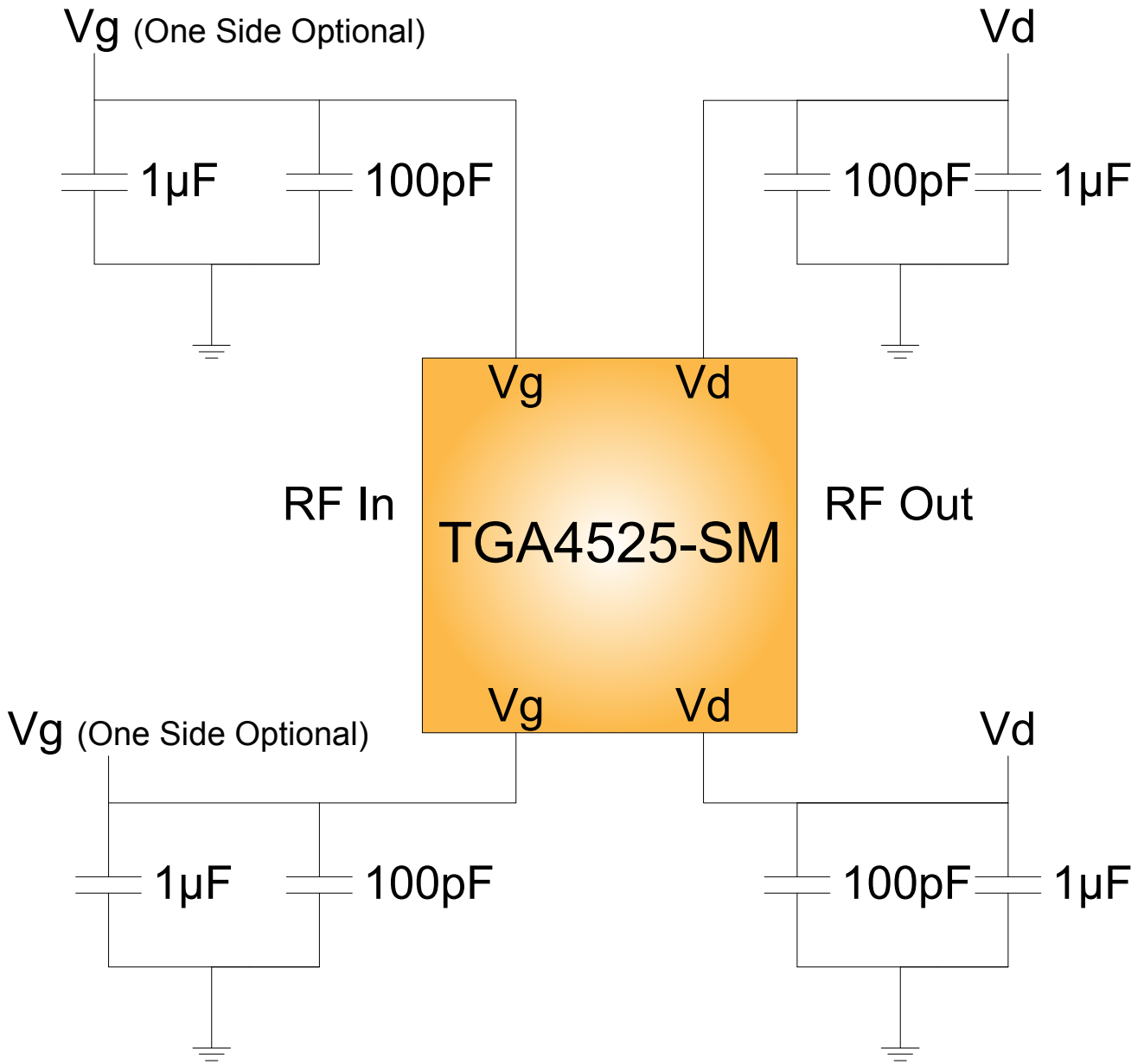

Vd = 5 to 7V

Vg = -0.55V Typical to get Id = 760mA

Recommended Surface Mount Package Assembly

Proper ESD precautions must be followed while handling packages.

TriQuint recommends using a conductive solder paste for attachment. Follow solder paste and reflow oven vendors' recommendations when developing a solder reflow profile. Typical solder reflow profiles are listed in the table below.

Hand soldering is not recommended. Solder paste can be applied using a stencil printer or dot placement. The volume of solder paste depends on PCB and component layout and should be well controlled to ensure consistent mechanical and electrical performance.

Compatible with high volume surface mount assembly processes using no-clean flux

Typical Solder Reflow Profiles

Reflow Profile	SnPb	Pb Free
Ramp-up Rate	3 °C/sec	3 °C/sec
Activation Time and Temperature	60 – 120 sec @ 140 – 160 °C	60 – 180 sec @ 150 – 200 °C
Time above Melting Point	60 – 150 sec	60 – 150 sec
Max Peak Temperature	240 °C	260 °C
Time within 5 °C of Peak Temperature	10 – 20 sec	10 – 20 sec
Ramp-down Rate	4 – 6 °C/sec	4 – 6 °C/sec

Ordering Information

Part	Package Style
TGA4525-SM	QFN 5x5 Surface Mount