

# SAW Bandpass Filter 270151B



## 1. Features

- IF Bandpass Filter
- Single-Ended Operation
- Ceramic Surface Mount Device (SMD) Package
- Maximum Storage Temperature Range : -40 °C ~ 85 °C
- Electrostatics Sensitive Device (ESD)

## 2. Package Dimensions

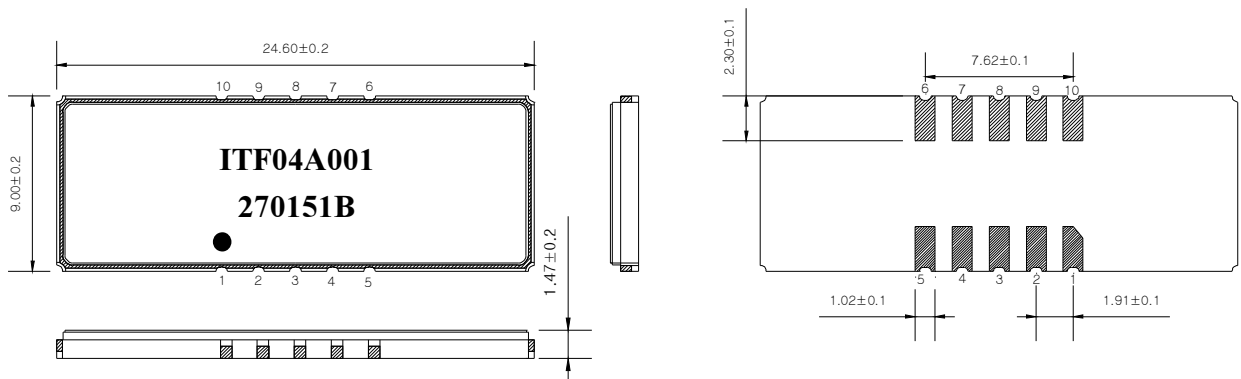

**Package : S2409**

Dimensions shown are nominal in millimeters

Body : Al<sub>2</sub>O<sub>3</sub> Ceramic

Lid : Kovar, Ni Plated

Terminations : Au plating 0.3 ~ 1.0 um, Over a 1.27 ~ 8.89 um Ni Plating

Pad Configuration	
10	Input
5	Output
1, 6	Ground
Other	Case ground

	<b>ITF Co., Ltd.</b> 102-901, Bucheon Technopark 364, Samjeong-Dong, Ojeong-Gu, Bucheon-City, Gyeonggi-Do, Korea 421-809	Part No.	270151B	
		Rev. Date	2004-12-02	
		Rev.	NW4016-CS01	1/5

# SAW Bandpass Filter 270151B



## 3. Specifications

Fo = 70.0 MHz

Terminating source impedance : 50Ω and matching network

Terminating load impedance : 50Ω and matching network

		Minimum	Typical	Maximum
Center Frequency	MHz	69.95	70.0	70.05
Insertion Loss	dB	-	20.0	23.0
1dB Bandwidth	MHz	1.0	1.1	-
3dB Bandwidth	MHz	1.23	1.28	-
40dB Bandwidth	MHz	-	2.05	2.15
Amplitude Ripple (Fo +/- 0.5 MHz)	dB	-	0.8	1.0
Group Delay Variation (Fo +/- 0.5 MHz)	nsec	-	200	400
Absolute Delay	usec	-	2.7	-
Ultimate Rejection	dB	45	50	-
Temperature Coefficient of Frequency	ppm/°C <sup>2</sup>	-	-0.03	-

### Notes :

- 1) All specifications are based on the matching schematic shown below
- 2) All specifications are measured by Agilent Network analyzer and full 2 port calibration at room temperature
- 3) All attenuation measurements are measured relative to insertion loss

	<b>ITF Co., Ltd.</b> 102-901, Bucheon Technopark 364, Samjeong-Dong, Ojeong-Gu, Bucheon-City, Gyeonggi-Do, Korea 421-809	Part No.	270151B	
		Rev. Date	2004-12-02	
		Rev.	NW4016-CS01	2/5

# SAW Bandpass Filter 270151B



## 4. Matching Schematic

( Actual matching values may vary due to PCB layout and parasitics )

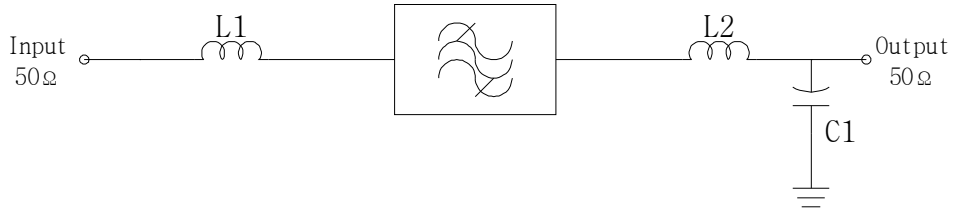

L1 = 180 nH,      L2 = 220 nH  
C1 = 100 pF

## 5. Marking Configuration

ITF<sup>1)</sup>04A001<sup>2)</sup>  
270151B<sup>3)</sup>  
●<sup>4)</sup>

- 1) Manufacturer name
- 2) Lot Number
- 3) Part Number
- 4) Pad Number 1 Index

	<b>ITF Co., Ltd.</b> 102-901, Bucheon Technopark 364, Samjeong-Dong, Ojeong-Gu, Bucheon-City, Gyeonggi-Do, Korea 421-809	Part No.	270151B	
		Rev. Date	2004-12-02	
		Rev.	NW4016-CS01	3/5

# SAW Bandpass Filter 270151B



## 6. Typical Performance ( at +25°C )

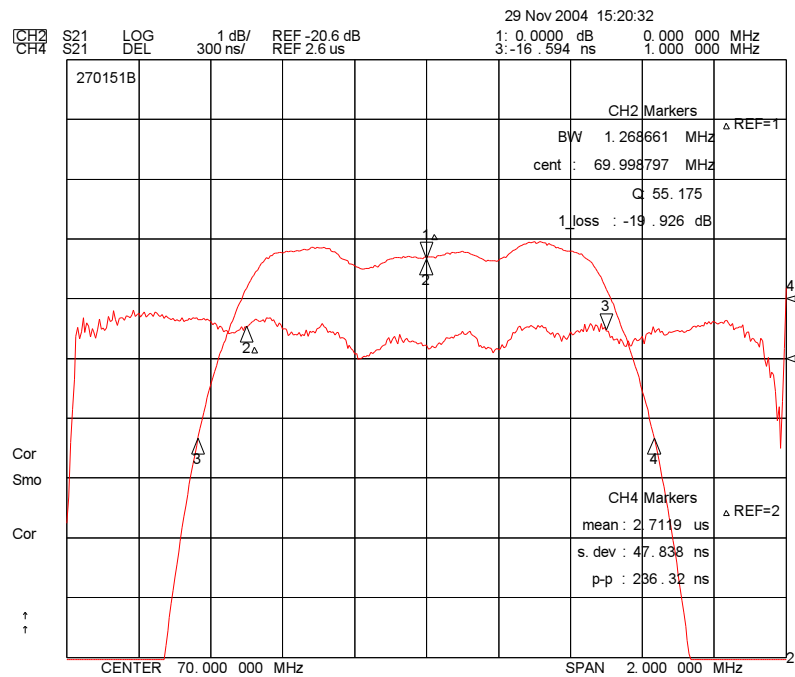
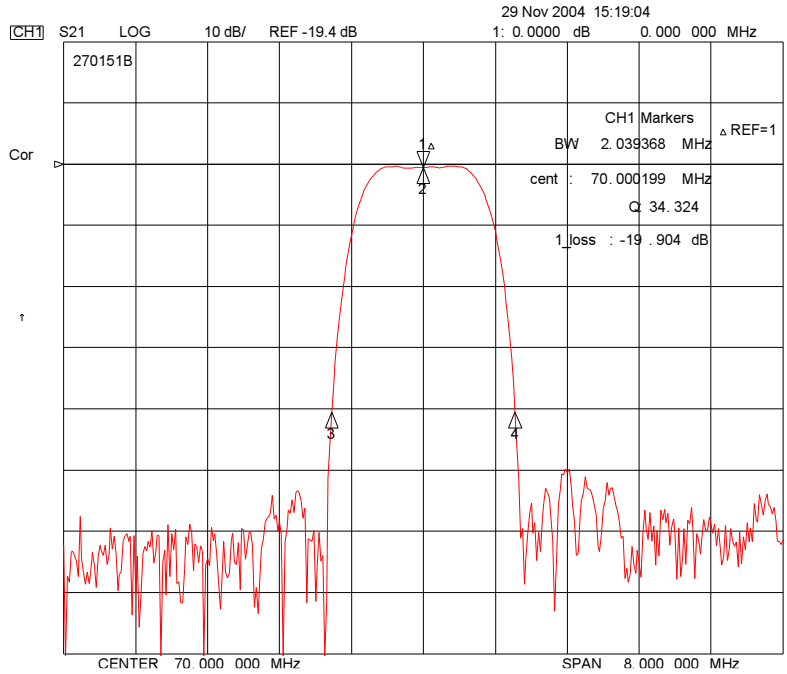

	<b>ITF Co., Ltd.</b> 102-901, Bucheon Technopark 364, Samjeong-Dong, Ojeong-Gu, Bucheon-City, Gyeonggi-Do, Korea 421-809	Part No.	270151B	
		Rev. Date	2004-12-02	
		Rev.	NW4016-CS01	4/5

# SAW Bandpass Filter 270151B

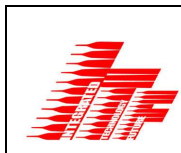
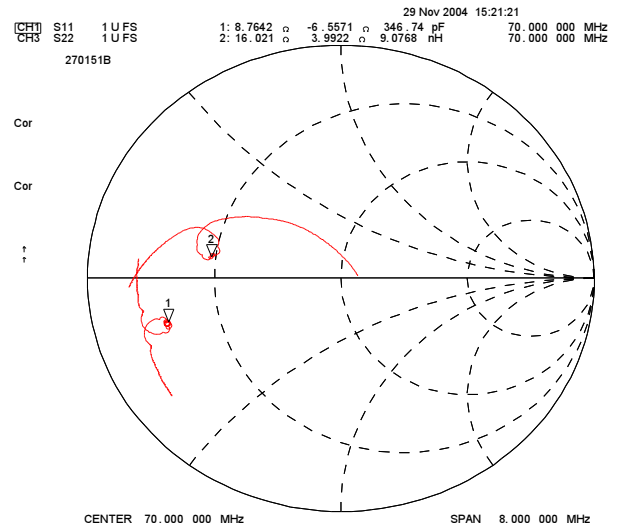
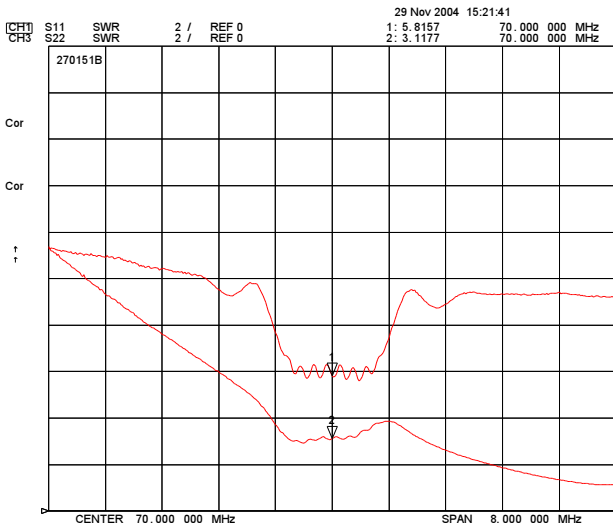
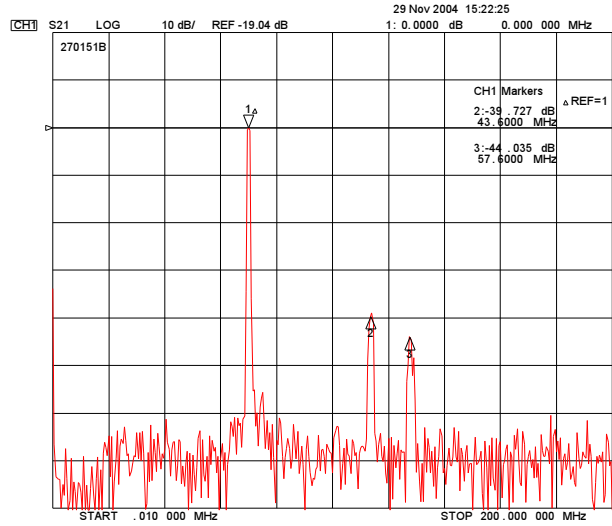
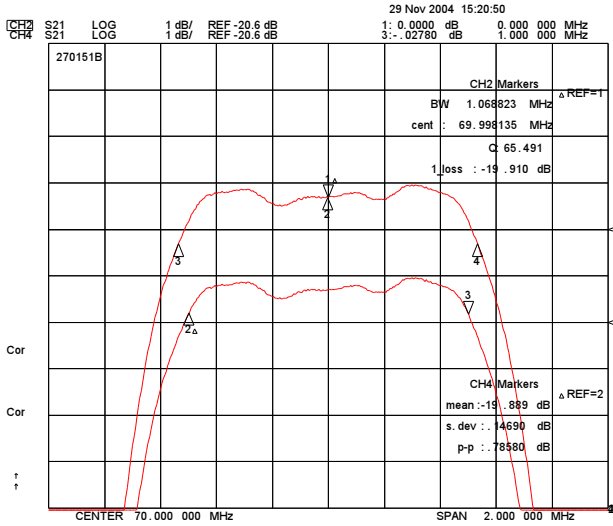

**ITF Co., Ltd.**  
 102-901, Bucheon Technopark 364,  
 Samjeong-Dong, Ojeong-Gu, Bucheon-City,  
 Gyeonggi-Do, Korea 421-809

Part No.	270151B	
Rev. Date	2004-12-02	
Rev.	NW4016-CS01	5/5