

Hyper ARGUS[®] LED

Hyper-Bright, 3mm (T1) LED, Non Diffused

LS K376, LA K376, LO K376, LY K376



Besondere Merkmale

- **Gehäusotyp:** nicht eingefärbtes, klares 3 mm (T1) Gehäuse mit spezieller Linse
- **Besonderheit des Bauteils:** mit Einsatz eines äußeren Reflektors zur Hinterleuchtung von Lichtfeldern und LCD-Anzeigen; Lötspieße mit Aufsetzebene
- **Wellenlänge:** 632 nm (super-rot), 615 nm (amber), 605 nm (orange), 587 nm (gelb)
- **Abstrahlwinkel:** angepasst an Einsatz mit äußerem Reflektor, siehe Diagramm
- **Technologie:** InGaAlP
- **optischer Wirkungsgrad:** 11 lm/W (gelb, orange, amber), 7 lm/W (super-rot)
- **Gruppierungsparameter:** Lichtstrom
- **Lötmethode:** Wellenlöten (TTW)
- **Verpackung:** Schüttgut, gegurtet lieferbar

Anwendungen

- Hinterleuchtung (LCD, Schalter, Tasten, Displays, Werbebeleuchtung, Allgemeinbeleuchtung)
- Innenbeleuchtung im Automobilbereich (z.B. Instrumentenbeleuchtung, u.ä.)
- Einkopplung in Lichtleiter

Features

- **package:** colorless, clear 3 mm (T1) package with specially shaped lens
- **feature of the device:** for backlighting and LCDs with use of a reflector; solder leads with stand-off
- **wavelength:** 632 nm (super-red), 615 (amber), 605 nm (orange), 587 nm (yellow)
- **viewing angle:** matched to use with external reflector, see diagram
- **technology:** InGaAlP
- **optical efficiency:** 11 lm/W (yellow, orange, amber), 7 lm/W (super-red)
- **grouping parameter:** luminous flux
- **soldering methods:** TTW soldering
- **packing:** bulk, available taped on reel

Applications

- backlighting (LCD, switches, keys, displays, illuminated advertising, general lighting)
- interior automotive lighting (e.g. dashboard backlighting, etc.)
- coupling into light guides

Typ Type	Emissions- farbe Color of Emission	Gehäusefarbe Color of Package	Lichtstrom Luminous Flux $I_F = 20 \text{ mA}$ $\Phi_V \text{ (mlm)}$	Bestellnummer Ordering Code
LS K376-QT LS K376-R LS K376-S LS K376-T LS K376-RU	super-red	colorless clear	71 ... 450 112 ... 180 180 ... 280 280 ... 450 112 ... 710	Q62703-Q3467 Q62703-Q3468 Q62703-Q3469 Q62703-Q3470 Q62703-Q3471
LA K376-RU LA K376-S LA K376-T LA K376-U LA K376-SV	amber	colorless clear	112 ... 710 180 ... 280 280 ... 450 450 ... 710 180 ... 1120	Q62703-Q3735 Q62703-Q3737 Q62703-Q3738 Q62703-Q3739 Q62703-Q3736
LO K376-RU LO K376-S LO K376-T LO K376-U LO K376-SV	orange	colorless clear	112 ... 710 180 ... 280 280 ... 450 450 ... 710 180 ... 1120	Q62703-Q3472 Q62703-Q3473 Q62703-Q3474 Q62703-Q3475 Q62703-Q3476
LY K376-RU LY K376-S LY K376-T LY K376-U LY K376-SV	yellow	colorless clear	112 ... 710 180 ... 280 280 ... 450 450 ... 710 180 ... 1120	Q62703-Q3477 Q62703-Q3478 Q62703-Q3479 Q62703-Q3480 Q62703-Q3481

Helligkeitswerte werden mit einer Stromeinprägedauer von 25 ms und einer Genauigkeit von $\pm 11 \%$ ermittelt.
Luminous intensity is tested at a current pulse duration of 25 ms and a tolerance of $\pm 11 \%$.

Anm.: Die Standardlieferform von Serientypen beinhaltet eine untere bzw. eine obere Familiengruppe oder mindestens zwei Einzelgruppen.

In einer Verpackungseinheit / Gurt ist immer nur eine Helligkeitsgruppe enthalten.

Die technologiebedingte Helligkeits-Streuung der heutigen LED-Herstellprozesse über einen längeren Fertigungszeitraum (Halbleitermaterial - Chipherstellung - Montageprozess) erlaubt keine Zusage einer einzelnen Helligkeitsgruppe. Daher müssen mindestens zwei Helligkeitsgruppen vorgesehen werden!

Note: The standard shipping format for serial types includes a lower or upper family group or at least two individual groups.

No packing unit / tape ever contains more than one luminous intensity group.

Luminosity variations caused by the technology used in current LED manufacturing processes over a protracted manufacturing period (semiconductor material - chip fabrication - assembly process) mean that it is not possible to assign LEDs to a single luminous intensity group. For this reason at least two luminous intensity groups must be provided!

Grenzwerte
Maximum Ratings

Bezeichnung Parameter	Symbol Symbol	Werte Values		Einheit Unit
		LS, LO, LA	LY	
Betriebstemperatur Operating temperature range	T_{op}	- 55 ... + 100		°C
Lagertemperatur Storage temperature range	T_{stg}	- 55 ... + 100		°C
Sperrschichttemperatur Junction temperature	T_j	+ 100		°C
Durchlassstrom Forward current	I_F	30		mA
Stoßstrom Surge current $t \leq 10 \mu s, D = 0.005$	I_{FM}	1	0.2	A
Sperrspannung Reverse voltage	V_R	3		V
Leistungsaufnahme Power consumption $T_A \leq 25 \text{ °C}$	P_{tot}	80		mW
Wärmewiderstand Thermal resistance Sperrschicht/Umgebung Junction/ambient	$R_{th JA}$	500		K/W
Sperrschicht/Löt看pad Junction/solder point Montage auf PC-Board FR 4 (Padgröße $\geq 16 \text{ mm}^2$) mounted on PC board FR 4 (pad size $\geq 16 \text{ mm}^2$) Minimale Beinchenlänge Minimum lead length	$R_{th JS}$	280		K/W

Kennwerte ($T_A = 25\text{ °C}$)

Characteristics

Bezeichnung Parameter	Symbol Symbol	Werte Values				Einheit Unit
		LS	LA	LO	LY	
Wellenlänge des emittierten Lichtes (typ.) Wavelength at peak emission $I_F = 20\text{ mA}$	λ_{peak}	645	622	610	591	nm
Dominantwellenlänge (typ.) Dominant wavelength $I_F = 20\text{ mA}$	λ_{dom}	632	615	605	587	nm
Spektrale Bandbreite bei 50 % $I_{\text{rel max}}$ (typ.) Spectral bandwidth at 50 % $I_{\text{rel max}}$ $I_F = 20\text{ mA}$	$\Delta\lambda$	16	16	16	15	nm
Durchlassspannung ¹⁾ (typ.) Forward voltage ¹⁾ (max.) $I_F = 20\text{ mA}$	V_F V_F	2.0 2.4	2.0 2.4	2.0 2.4	2.0 2.4	V V
Sperrstrom (typ.) Reverse current (max.) $V_R = 3\text{ V}$	I_R I_R	0.01 10	0.01 10	0.01 10	0.01 10	μA μA
Temperaturkoeffizient von λ_{peak} (typ.) Temperature coefficient of λ_{peak} $I_F = 20\text{ mA}; -10\text{ °C} \leq T \leq 100\text{ °C}$	$TC_{\lambda_{\text{peak}}}$	0.14	0.13	0.13	0.13	nm/K
Temperaturkoeffizient von λ_{dom} (typ.) Temperature coefficient of λ_{dom} $I_F = 20\text{ mA}; -10\text{ °C} \leq T \leq 100\text{ °C}$	$TC_{\lambda_{\text{dom}}}$	0.01	0.06	0.07	0.10	nm/K
Temperaturkoeffizient von V_F (typ.) Temperature coefficient of V_F $I_F = 20\text{ mA}; -10\text{ °C} \leq T \leq 100\text{ °C}$	TC_V	-2.0	-1.8	-1.7	-2.5	mV/K
Optischer Wirkungsgrad (typ.) Optical efficiency $I_F = 20\text{ mA}$	η_{opt}	7	11	11	11	lm/W

¹⁾ Spannungswerte werden mit einer Stromeinprägungsdauer von 1 ms und einer Genauigkeit von $\pm 0.1\text{ V}$ ermittelt.
Voltages are tested at a current pulse duration of 1 ms and a tolerance of $\pm 0.1\text{ V}$.

Relative spektrale Emission $I_{rel} = f(\lambda)$, $T_A = 25\text{ °C}$, $I_F = 20\text{ mA}$

Relative Spectral Emission

$V(\lambda)$ = spektrale Augenempfindlichkeit

Standard eye response curve

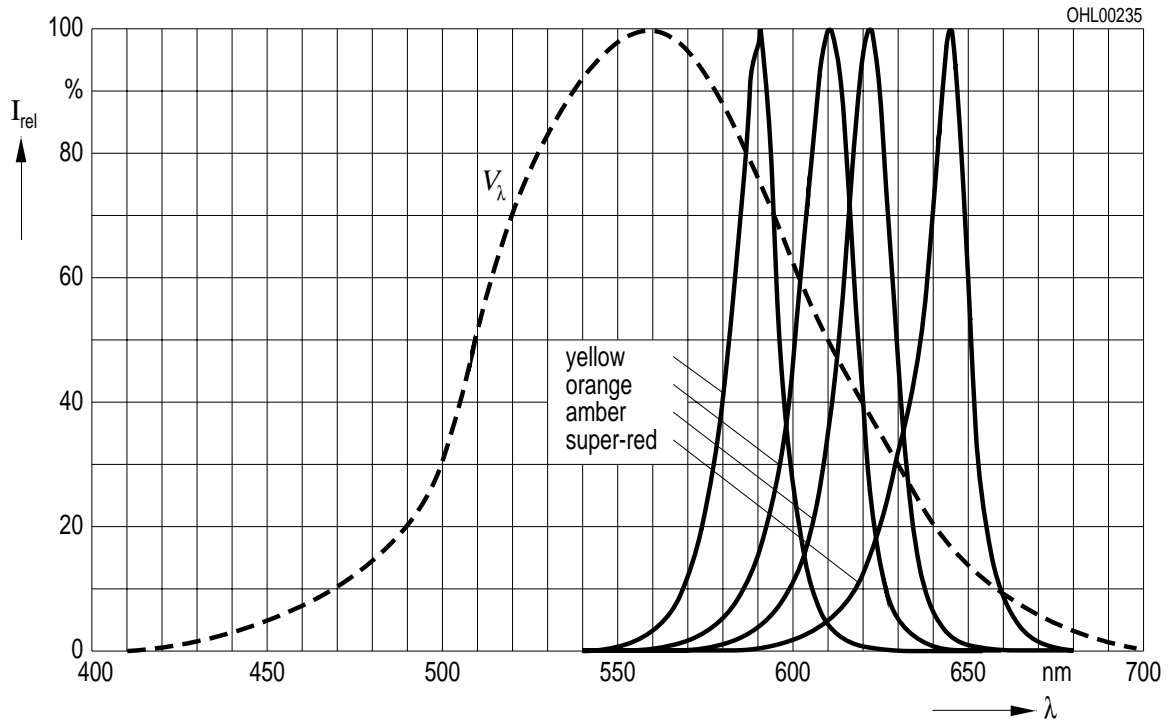

Abstrahlcharakteristik $I_{rel} = f(\varphi)$

Radiation Characteristic

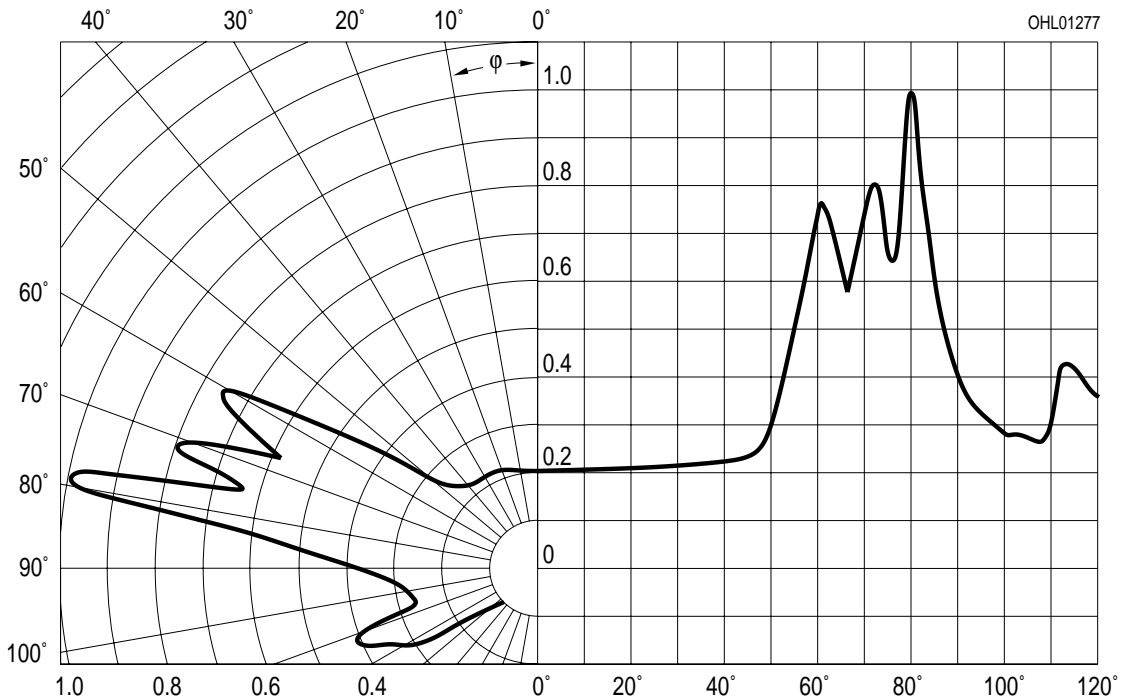

Durchlassstrom $I_F = f(V_F)$
Forward Current

$T_A = 25\text{ °C}$

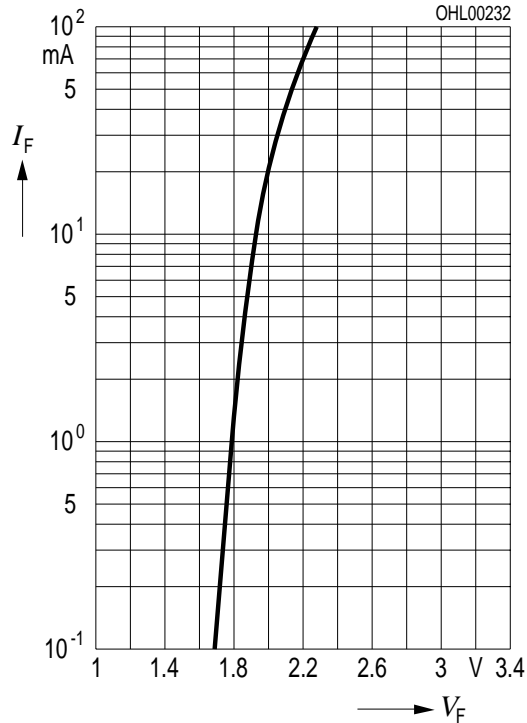

Relativer Lichtstrom $\Phi_V/\Phi_{V(20\text{ mA})} = f(I_F)$
Relative Luminous Flux

$T_A = 25\text{ °C}$

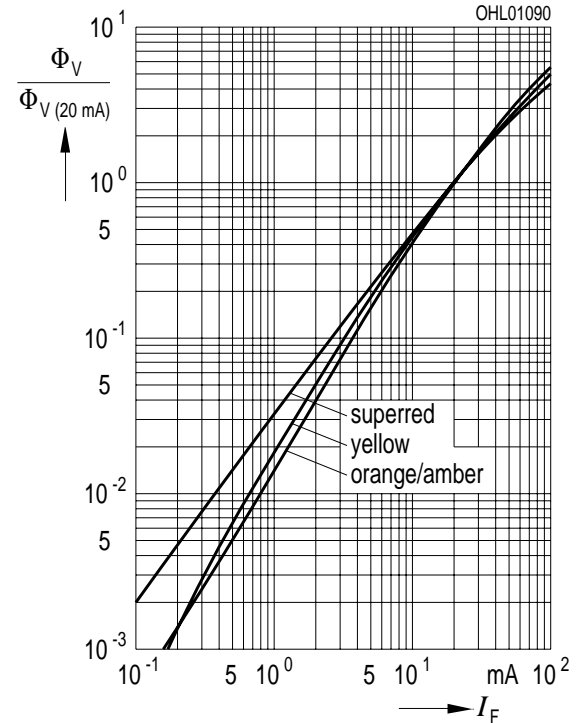

Maximal zulässiger Durchlassstrom $I_F = f(T)$
Max. Permissible Forward Current

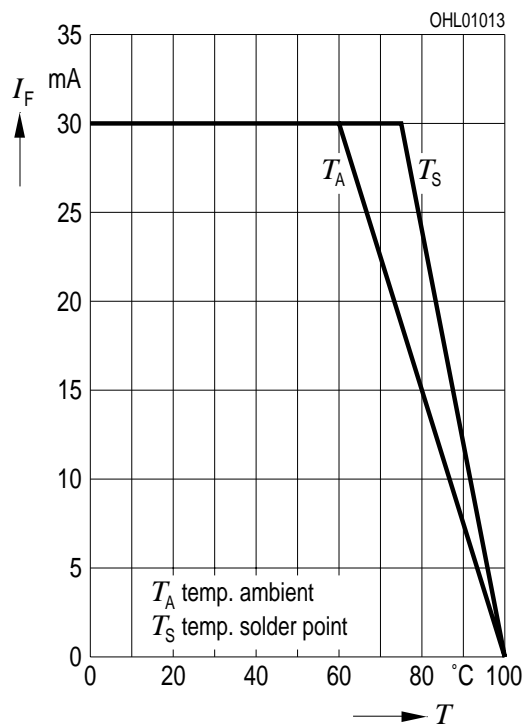

Relativer Lichtstrom $\Phi_V/\Phi_{V(25\text{ °C})} = f(T_A)$
Relative Luminous Flux

$I_F = 20\text{ mA}$

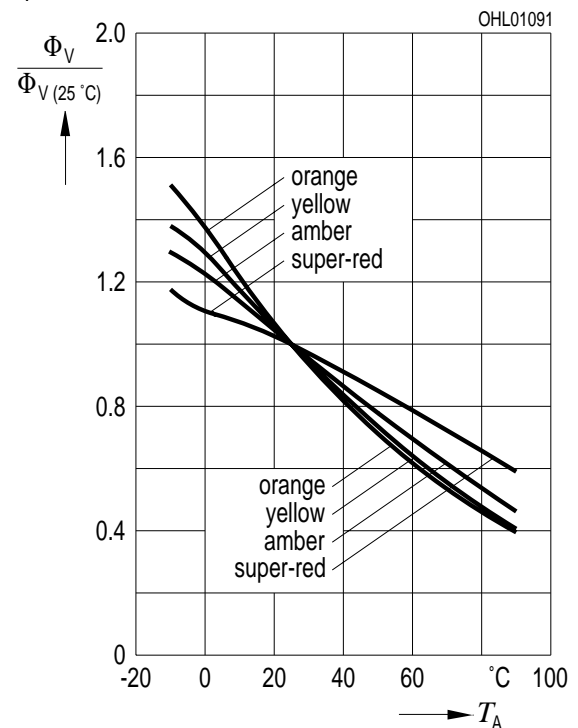

Zulässige Impulsbelastbarkeit $I_F = f(t_p)$
Permissible Pulse Handling Capability
 Duty cycle $D =$ parameter, $T_A = 25\text{ °C}$
LS, LA, LO

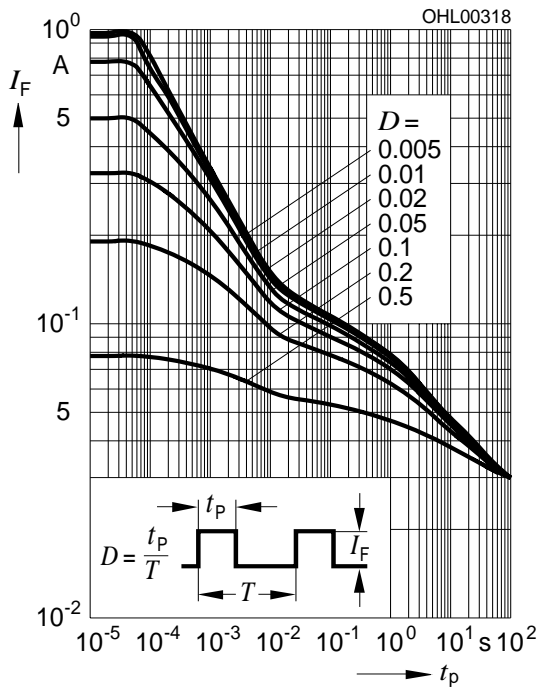

Zulässige Impulsbelastbarkeit $I_F = f(t_p)$
Permissible Pulse Handling Capability
 Duty cycle $D =$ parameter, $T_A = 25\text{ °C}$
LY

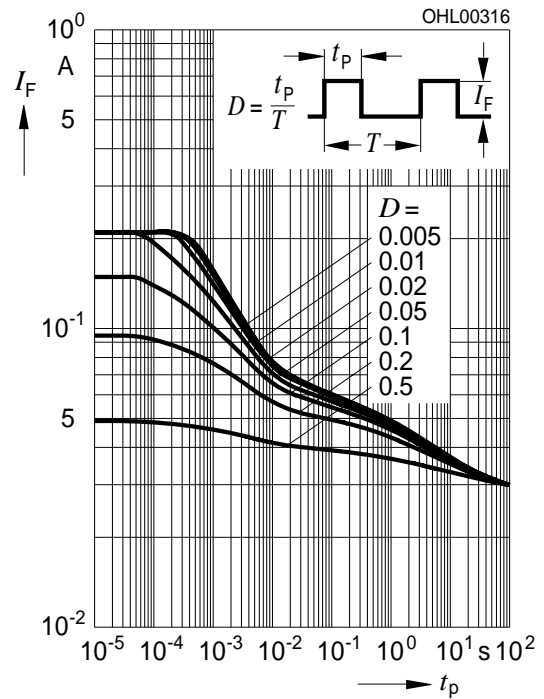

Zulässige Impulsbelastbarkeit $I_F = f(t_p)$
Permissible Pulse Handling Capability
 Duty cycle $D =$ parameter, $T_A = 85\text{ °C}$
LS, LA, LO

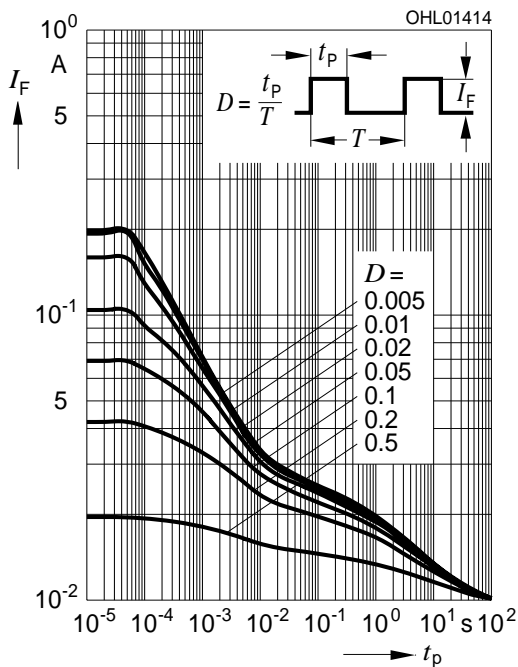

Zulässige Impulsbelastbarkeit $I_F = f(t_p)$
Permissible Pulse Handling Capability
 Duty cycle $D =$ parameter, $T_A = 85\text{ °C}$
LY

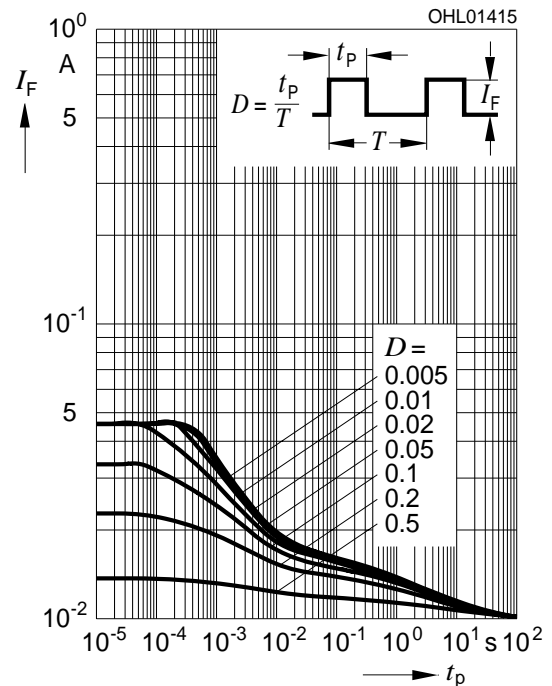

Maßzeichnung
Package Outlines

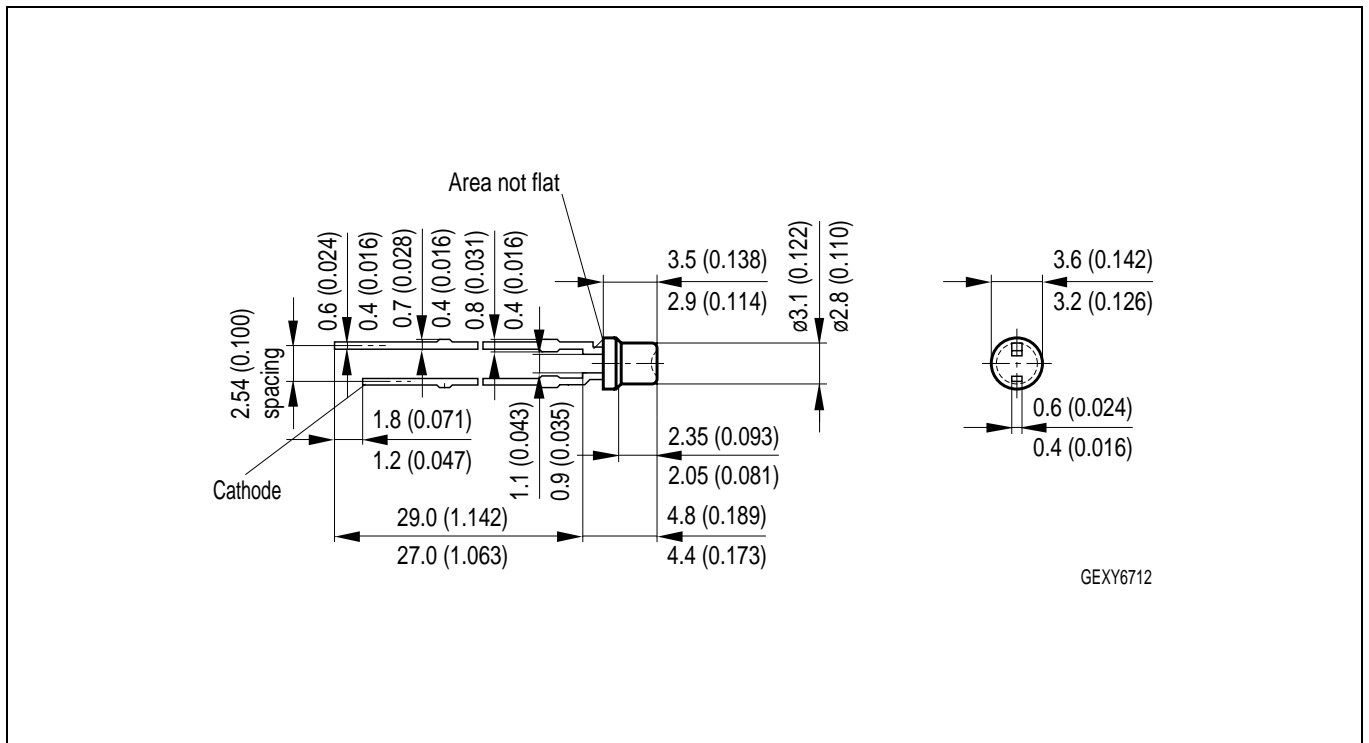

Maße werden wie folgt angegeben: mm (inch) / Dimensions are specified as follows: mm (inch).

Kathodenkennung: kürzerer Lötspieß
Cathode mark: short solder lead
Gewicht / Approx. weight: 160 mg

Lötbedingungen
Soldering Conditions

Wellenlöten (TTW) (nach CECC 00802)
TTW Soldering (acc. to CECC 00802)

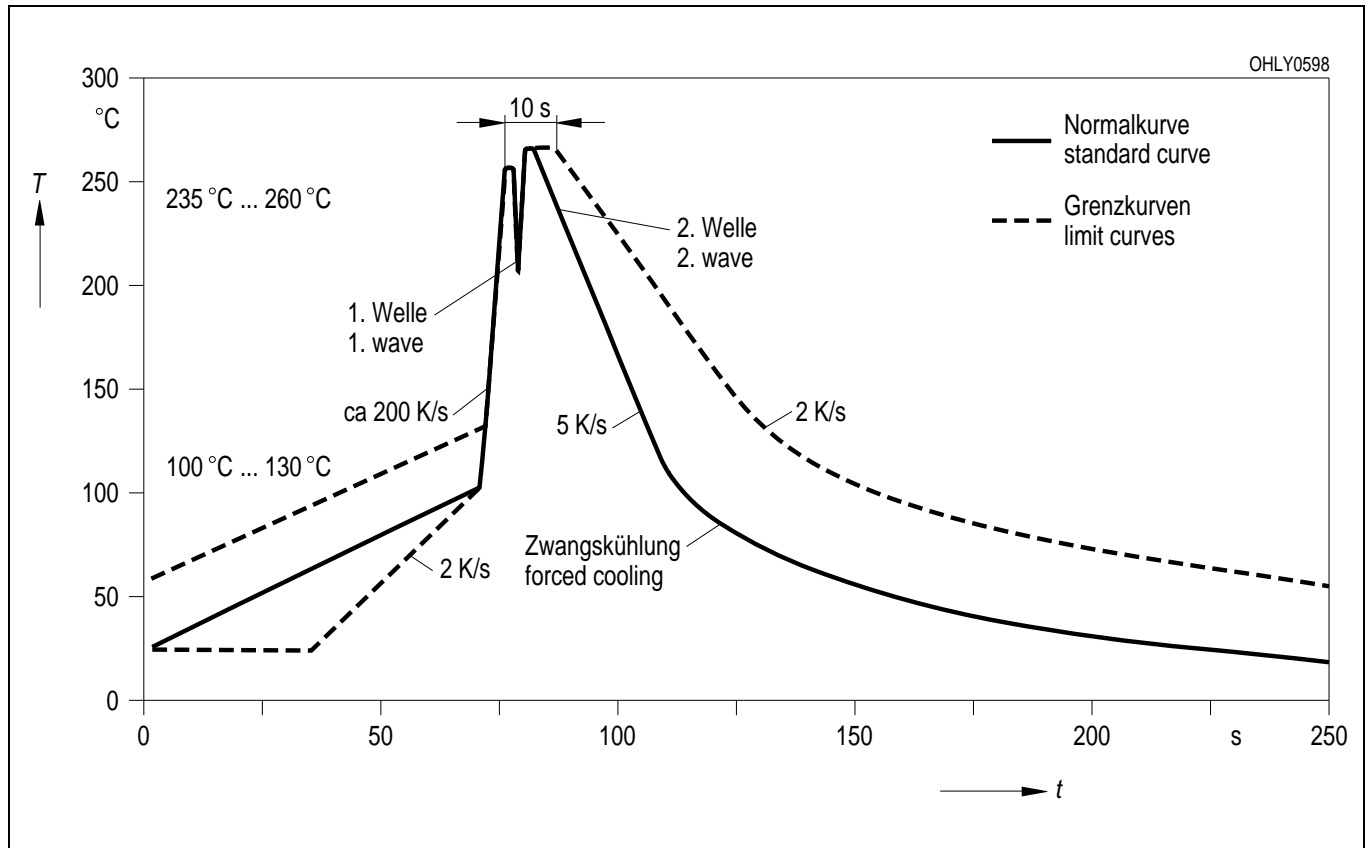

Empfohlenes Lötpaddesign Wellenlöten (TTW)
Recommended Solder Pad TTW Soldering

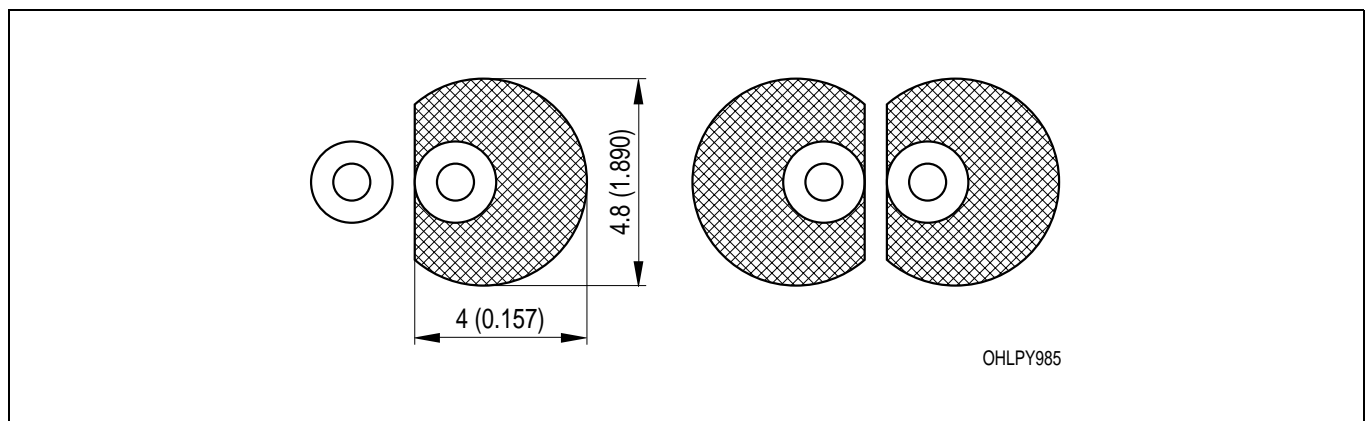

Maße werden wie folgt angegeben: mm (inch) / Dimensions are specified as follows: mm (inch)

Revision History: 2001-02-13

Previous Version: 2001-02-13

Page	Subjects (major changes since last revision)

Published by OSRAM Opto Semiconductors GmbH & Co. OHG

Wernerwerkstrasse 2, D-93049 Regensburg

© All Rights Reserved.

Attention please!

The information describes the type of component and shall not be considered as assured characteristics. Terms of delivery and rights to change design reserved. Due to technical requirements components may contain dangerous substances. For information on the types in question please contact our Sales Organization. If printed or downloaded, please find the latest version in the Internet.

Packing

Please use the recycling operators known to you. We can also help you – get in touch with your nearest sales office. By agreement we will take packing material back, if it is sorted. You must bear the costs of transport. For packing material that is returned to us unsorted or which we are not obliged to accept, we shall have to invoice you for any costs incurred.

Components used in life-support devices or systems must be expressly authorized for such purpose! Critical components ¹ may only be used in life-support devices or systems ² with the express written approval of OSRAM OS.

¹ A critical component is a component used in a life-support device or system whose failure can reasonably be expected to cause the failure of that life-support device or system, or to affect its safety or the effectiveness of that device or system.

² Life support devices or systems are intended (a) to be implanted in the human body, or (b) to support and/or maintain and sustain human life. If they fail, it is reasonable to assume that the health of the user may be endangered.