

PLEASE CHECK WWW.MOLEX.COM FOR LATEST PART INFORMATION

Part Number: [0549280471](#)
Status: **Active**
Description: 7.50mm (.295") Pitch MTC™ Spring Type Receptacle, 4 Circuits Version, Black Color

Documents:

[Drawing \(PDF\)](#) [RoHS Certificate of Compliance \(PDF\)](#)
[Product Specification PS-51241-005 \(PDF\)](#)

Agency Certification

CSA LR19980
 UL E29179

General

Product Family Terminal Blocks
 Series [54928](#)
 Application Wire-to-Board
 Component Type Plug
 Product Name MTC™
 Type Euro Block

Physical

Circuits (Loaded) 4
 Circuits (maximum) 4
 Color - Resin Black
 Entry Angle Vertical
 Flammability 94V-0
 Lock to Mating Part Yes
 Material - Resin Polyester
 Number of Rows 1
 Orientation Vertical
 Panel Mount No
 Pitch - Mating Interface (in) 0.295 In
 Pitch - Mating Interface (mm) 7.50 mm
 Pitch - Term. Interface (in) 0.295 In
 Pitch - Term. Interface (mm) 7.50 mm
 Polarized to Mating Part Yes
 Shrouded Fully
 Stackable No
 Temperature Range - Operating -30°C to +85°C
 Wire Size AWG 14, 16, 18, 20, 22, 24, 26

Electrical

Current - Maximum per Contact 16A
 Voltage - Maximum 400V

Material Info

Reference - Drawing Numbers

Product Specification PS-51241-005
 Sales Drawing SD-54928-004

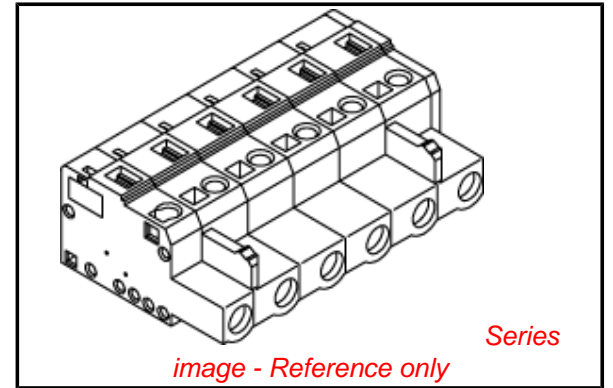

EU RoHS

**ELV and RoHS
 Compliant**
REACH SVHC
 Not Reviewed
**Halogen-Free
 Status**
Not Reviewed

China RoHS



**Need more information on product
 environmental compliance?**

Email productcompliance@molex.com
 For a multiple part number RoHS Certificate of
 Compliance, [click here](#)

Please visit the [Contact Us](#) section for any
 non-product compliance questions.

Search Parts in this Series

[54928Series](#)

Mates With

[55759](#)

DWG. NO. SD-54928-004

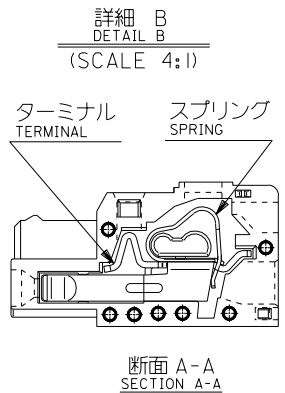
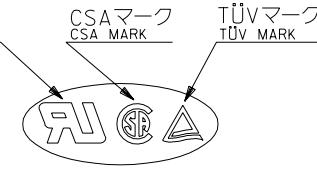
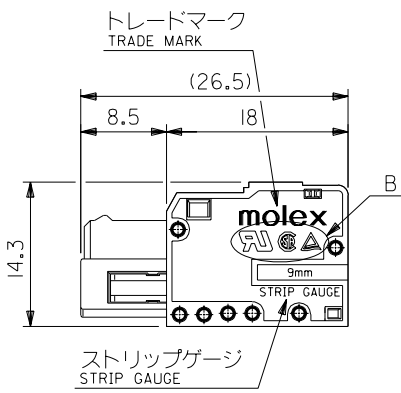
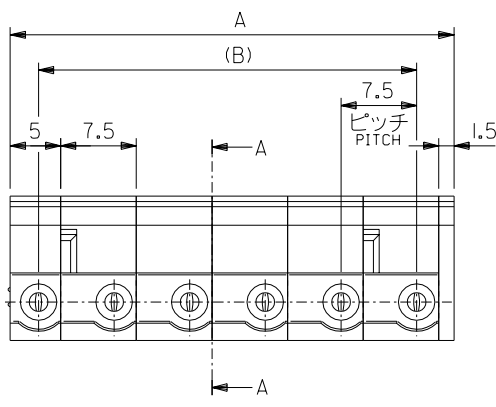
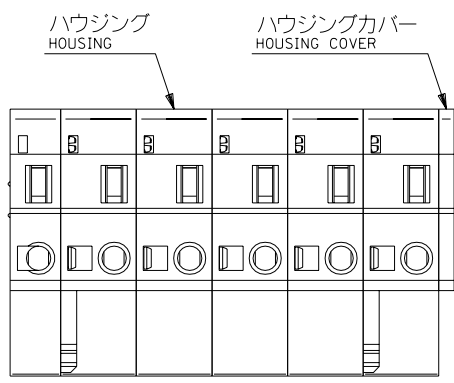
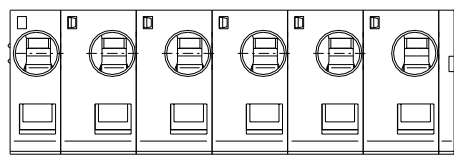

注記 NOTES:

1. 材質 MATERIAL

- ハウジング, ハウジングカバー
HOUSING, HOUSING COVER
ガラス無しポリブチレンテレフタレート, UL94V-0
POLYBUTYLENE TEREPHTHALATE, GLASS NON FILLED, UL94V-0
- ターミナル
TERMINAL
銅合金
COPPER ALLOY
- スプリング
SPRING
ステンレス
STAINLESS STEEL

2. メッキ仕様 PLATING

- 鍍メッキ: 1.0µm MIN.
TIN PLATING: 1.0 MICROMETER MINIMUM
- ニッケルメッキ: 1.0µm MIN. (下地メッキ)
NICKEL PLATING: 1.0 MICROMETER MINIMUM (UNDER PLATING)

3. 適用電線範囲: AWG#14 ~ #26
APPLICABLE WIRE: AWG#14 ~ #26

4. 被覆外径: φ3.8 MAX.
INS. DIA.: φ3.8 MAX.

5. 適合レバー: 54932 シリーズ
APPLIED LEVER: 54932 SERIES

6. 製品番号
MATERIAL NO. 54928-***7*

| 極数 CIRCUIT SIZE | 色 COLOR |
|-----------------|---------|
| アイボリー IVORY | 0 |
| 黒 BLACK | 1 |
| 灰 GRAY | 5 |

7. 被覆剥き長さ: 8 ~ 9mm
INSULATION STRIPPING LENGTH: 8 ~ 9mm

8. 本製品は 54928-***1* の鉛フリー品である。
THIS PRODUCT IS LEAD FREE OF 54928-***1*.

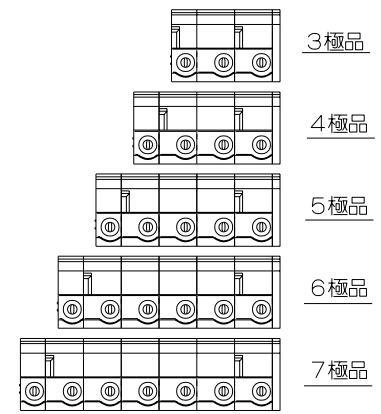

| | | | |
|------|------|-------------------|-------------|
| 45 | 51.5 | 54928-077* | 7 |
| 37.5 | 44 | 54928-067* | 6 |
| 30 | 36.5 | 54928-057* | 5 |
| 22.5 | 29 | 54928-047* | 4 |
| 15 | 21.5 | 54928-037* | 3 |
| B | A | 製品番号 MATERIAL NO. | 極数 CIRCUITS |

DO NOT SCALE DRAWING

| EC NO. | DRWN: | CHK: | APPR: |
|--------|-------|------|-------|
| | | | |

| REV | DESCRIPTION | MATERIAL 材料 | FINISH 仕上げ | WIRE RANGE 適用電線範囲 | INS. RANGE 被覆外径 |
|-----|---|-------------------|-------------------|-------------------|-------------------|
| 0 | RELEASED EC NO. J2004-3622 DRWN: H.KAWABATA '04/04/07 CHK: K.TOJO '04/04/07 APPR: M.SASAO '04/04/07 | 注記参照 SEE NOTES | 注記参照 SEE NOTES | 注記参照 SEE NOTES | 注記参照 SEE NOTES |

| GENERAL TOLERANCES: (UNLESS SPECIFIED) 一般公差 | SCALE 2:1 | DESIGN UNITS □mm □INCH |
|---|-----------|---|
| 10 UNDER 未満 ±0.2 | | DRAWN BY & DATE H.KAWABATA '04/04/07 |
| 10 OVER 以上 30 UNDER 未満 ±0.25 | | CHECKED BY & DATE K.TOJO '04/04/07 |
| 30 OVER 以上 ±0.3 | | APPROVED BY & DATE M.SASAO '04/04/07 |
| ANGLE 角度 ±3° | | CAD FILENAME SD-54928-004.S01 |

| MODEL NO. | 54928-***7* | TITLE: | MATERIAL NO. | DRAWING NO. | SHEET NO. |
|--|-------------|--|--------------|--------------|-----------|
| | | MTC (MULTI TERMINAL CONN.) 7.5mm PITCH REC. HS'G ASS'Y -LEAD FREE- | SEE CHART | SD-54928-004 | 1 OF 2 |
| THIS DRAWING CONTAINS INFORMATION THAT IS PROPRIETARY TO MOLEX INCORPORATED AND SHOULD NOT BE USED WITHOUT WRITTEN PERMISSION. | | | | | |

DWG. NO. SD-54928-004

8 ストリップゲージの使用方法
USE OF STRIP GAUGE

ハウジングカバーに付いているストリップゲージは、以下のご使用下さい。
PLEASE USE THE STRIP GAUGE WHICH HAS ADHERED TO THE HOUSING COVER AS SHOWN IN THE FIGURE BELOW.

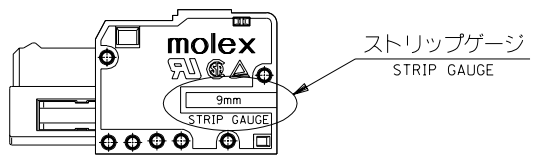

1. 電線をストリップゲージに合わせて被覆を剥く。
THE ELECTRIC WIRE IS MATCHED TO THE STRIP GAUGE, AND STRIPPING INSULATION.

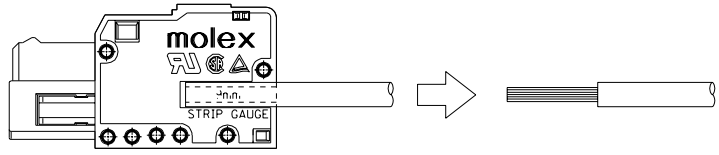

2. 既に被覆を剥いた電線をストリップゲージに合わせて被覆剥き長さを確認する。
THE ELECTRIC WIRE WHICH HAS ALREADY PEELLED OFF INSULATION IS MATCHED TO THE STRIP GAUGE, AND THE STRIPPING LENGTH IS CONFIRMED.

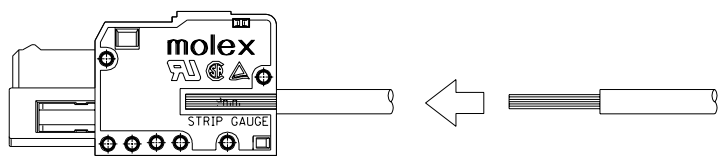

※ 被覆剥き長さ : 8 ~ 9mm
STRIPPING LENGTH : 8 ~ 9mm

5 結線方法
METHOD OF CONNECTING WIRES

3 結線レバー
LEVER
54932-****

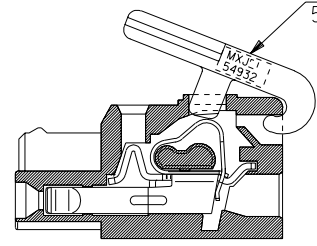

1. 結線レバーをハウジングに装着する。(脱着自在)
THE LEVER OF CONNECTING WIRES IS INSTALLED IN THE HOUSING. (DETACHING IS FREE)

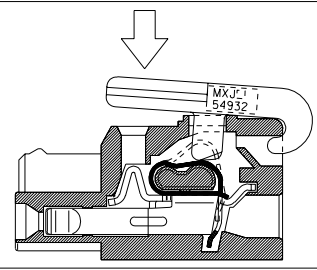

2. 結線レバーを矢印方向に押す。
THE LEVER OF CONNECTING WIRES IS PUSHED IN THE DIRECTION OF THE ARROW.

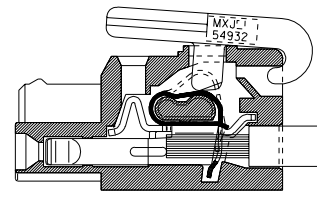

3. 結線レバーを押したまま電線を矢印方向に挿入する。
THE ELECTRIC WIRE IS INSERTED IN THE DIRECTION OF THE ARROW WITH THE LEVER OF CONNECTING WIRES PUSHED.

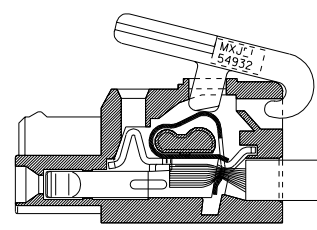

4. 結線レバーを放す。
THE LEVER OF CONNECTING WIRES IS RELEASED.

DO NOT SCALE DRAWING

| | | | |
|-------------------|-------------------|-------------------|-------------------|
| EC NO. | EC NO. | EC NO. | EC NO. |
| DRWN: CH'K: APPR: | DRWN: CH'K: APPR: | DRWN: CH'K: APPR: | DRWN: CH'K: APPR: |
| 8 | 7 | 6 | 5 |

| | | | | | |
|-----|-------------|-------------------|-------------------|-------------------|-------------------|
| REV | DESCRIPTION | MATERIAL | FINISH | WIRE RANGE | INS. RANGE |
| 0 | RELEASED | 材料 | 仕上げ | 適用電線範囲 | 被覆外径 |
| | | 注記参照 SEE NOTES | 注記参照 SEE NOTES | 注記参照 SEE NOTES | 注記参照 SEE NOTES |

| | | |
|---|-------|--------------|
| GENERAL TOLERANCES: (UNLESS SPECIFIED) 一般公差 | SCALE | DESIGN UNITS |
| 10 UNDER 未満 | 2:1 | mm INCH |
| 10 OVER 以上 | | |
| 30 UNDER 未満 | | |
| 30 OVER 以上 | | |
| ANGLE 角度 | | |

| | | |
|----------------------|-------------------|------------------------|
| MODEL NO. | DESIGN UNITS | THIRD ANGLE PROJECTION |
| 54928-***7* | mm INCH | mm ONLY |
| DRAWN BY & DATE | CHECKED BY & DATE | APPROVED BY & DATE |
| H.KAWABATA '04/04/07 | K.TOJO '04/04/07 | M.SASAO '04/04/07 |
| CAD FILENAME | MATERIAL NO. | DRAWING NO. |
| SD-54928-004.S02 | SEE CHART | SD-54928-004 |

| | | |
|--|--------------|-----------|
| TITLE: | SHT | REV |
| MTC (MULTI TERMINAL CONN.) 7.5mm PITCH REC. HS'G ASS'Y -LEAD FREE- | 2 OF 2 | REVISIONS |
| MATERIAL NO. | DRAWING NO. | SHEET NO. |
| SEE CHART | SD-54928-004 | 2 OF 2 |
| THIS DRAWING CONTAINS INFORMATION THAT IS PROPRIETARY TO MOLEX INCORPORATED AND SHOULD NOT BE USED WITHOUT WRITTEN PERMISSION. | | SIZE |
| | | B |