

***AEH/ALH80 Single Output Baseplate/Open-Frame DC-DC Converter Module  
Industry Standard ½ Brick: 36V-75V Input / 80A Output Current***

The AEH/ALH80 series is part of Astec's next generation single output, high-density industry standard half bricks. It operates from a 36V to 75V DC Bus and comes in three different Isolated Logic Output voltages (ILO) well suited for DPA applications. It's designed to handle 80A maximum output current for 1.8V, 1.5V and 1.2V at high levels of efficiency. It provides tight regulation and exhibits clean and monotonic output start up characteristics. The AEH/ALH80 comes with industry standard features such as Input UVLO, OCP, OVP, OTP, output Trim, differential output Sense pins. It comes either with baseplate or open frame construction, with double pair or single pair (option) output pins.



**Special Features**

- Industry Standard ½ Brick Footprint
- Positive and Negative Enable Options
- Regulation to Zero Load
- High Capacitive Load Start-up
- Fixed Switching Frequency at 400kHz
- Output Trim
- Input Under-Voltage Lockout
- Low profile / open-frame
- Double pair or single pair output pins option

**Environmental Specifications**

- -40°C to 85°C Operating Temperature
- -40°C to 125°C Storage Temperature
- MTBF > 1 million hours

**Electrical Parameters**

**Input**

Input Range	36-75 VDC
Input Surge	100V / 100ms
Efficiency	1.8V @ 87.0%
	1.5V @ 85.5%
	1.2V @ 83.0%

**Control**

Enable	TTL compatible
(Positive and Negative Enable Options)	

**Output**

Load Current	80A max
Line/Load Regulation	< 1% V <sub>O</sub>
Ripple and Noise	50mV <sub>PK-PK</sub> (Typ)
Output Voltage	
Adjust Range	±10% V <sub>O</sub>
Transient Response	<5% V <sub>O</sub> deviation (Typ)
	50% to 75% Load Change
	250msec settling time (Typ)
Remote Sense	+10% V <sub>O</sub>
Over Current	
Protection	120% I <sub>O,MAX</sub>

**Safety**

UL + cUL 60950, Recognized  
EN60950 through TUV-PS  
CB Test Report



## Technical Reference Notes AEH/ALH80 Series



### AEH/ALH80 Series

MODEL NAME	CONSTRUCTION	V <sub>OUT</sub> / I <sub>OUT</sub>
AEH80Y48	Baseplate adapted	1.8V / 80A
AEH80M48	Baseplate adapted	1.5V / 80A
AEH80K48	Baseplate adapted	1.2V / 80A
ALH80Y48	Open Frame; Low Profile	1.8V / 80A
ALH80M48	Open Frame; Low Profile	1.5V / 80A
ALH80K48	Open Frame; Low Profile	1.2V / 80A

#### OPTIONS:

Negative Enable:

Positive Enable (Default):

Single Pair Output Pins:

Redundant Output Pins (Default):

#### SUFFIX

"N"

No suffix

"-3"

No suffix



## Technical Reference Notes AEH/ALH80 Series



### Electrical Specifications

STANDARD TEST CONDITION on a single module unless otherwise specified.

$T_A$		25°C (Ambient Air)
Airflow		Refer to Figures 21 to 24
+V <sub>IN</sub>	PIN 1	Return pin for +V <sub>IN</sub>
Enable	PIN 2	Dependent on model series
-V <sub>IN</sub>	PIN 3	48V ± 2V
-V <sub>OUT</sub>	PIN 4	Connected to Load
-Sense	PIN 5	Connected to +V <sub>OUT</sub>
Trim	PIN 6	Open
+Sense	PIN 7	Connected to -V <sub>OUT</sub>
+V <sub>out</sub>	PIN 8	Connected to Load (return)

### ABSOLUTE MAXIMUM RATINGS

Stresses in excess of the absolute maximum ratings can cause permanent damage to the converter. Functional operation of the device is converter is not implied at these or any other conditions in excess of those given in the operational section of the specs. Exposure to absolute maximum ratings for extended period can adversely affect device reliability.

Parameter	Device	Symbol	Min	Typ	Max	Unit
Input Voltage <sup>1</sup>						
Continuous	All	V <sub>IN</sub>	0	-	75	Vdc
Transient (100ms)	All	V <sub>IN,trans</sub>	0	-	100	Vdc
Isolation Voltage						
Input to Output	All		-	-	1500	Vdc
Input to Case	AEH				1500	Vdc
Output to Case					1500	Vdc
Operating Ambient Temperature	ALH	T <sub>A</sub>	-40	-	+85	°C
	AEH	T <sub>C</sub>	-40	-	100	
Storage Temperature	All	T <sub>STG</sub>	-55	-	125	°C
Operating Humidity	All	-	-	-	85	%
Maximum Enable Voltage	All				25	Vdc
Max Output Power	Y (1.8V)	P <sub>O</sub>	-	-	144	W
	M (1.5V)	P <sub>O</sub>	-	-	120	W
	K (1.2V)	P <sub>O</sub>	-	-	96	W



## Technical Reference Notes AEH/ALH80 Series



### Electrical Specifications (continued)

#### INPUT SPECIFICATION

Parameter	Device	Symbol	Min	Typ	Max	Unit
Operating Input Voltage	All	$V_{IN}$	36	48	75	$V_{DC}$
Input Under-Voltage Lock-out T_ON Threshold	All		34.0	34.8	35.5	Vdc
T_OFF Threshold			32.5	33.5	34.5	
Maximum Input Current <sup>1</sup> Conditions: $V_{IN} = V_{IN,min}$ $I_O = I_{O,max}$ ; $T_A = 25\text{ }^\circ\text{C}$	Y (1.8V) M (1.5V) K (1.2V)	$I_{IN,max}$	-	-	5.2 4.4 3.6	A
Max $P_{DISS}$ @ $I_O = 0A$ ( $V_{IN} = V_{IN,NOM}$ )	All		-	-	5	W
Input Reflected Ripple Current <sup>2</sup> Conditions: $P_O = P_{O,max}$ ; $T_A = 25\text{ }^\circ\text{C}$ BW: 5Hz to 20MHz	All	$I_{I1}/I_{I2}$	-	-	15	$mA_{PK-PK}$

Note: 1. An input line fuse is recommended for use (e.g. Littlefuse type 3AB 314, 8A/250V or equivalent).  
2. External input capacitance required. See Input Ripple Current test measurement setup on Fig 1.

#### OUTPUT SPECIFICATIONS

Parameter	Device	Symbol	Min	Typ	Max	Unit
Output Voltage Set point $V_{IN} = V_{IN,min}$ to $V_{IN,max}$ ; $I_O = I_{O,Max}$	1V8 (Y) 1V5 (M) 1V2 (K)	$V_{O,SET}$	1.770 1.475 1.180	1.800 1.500 1.200	1.830 1.525 1.220	Vdc Vdc Vdc
Output Regulation Line: $V_{IN} = V_{IN,Min}$ to $V_{IN,Max}$ Load: $I_O = I_{O,Min}$ to $I_{O,Max}$ Temperature: $T_a = -40\text{ }^\circ\text{C}$ to $+85\text{ }^\circ\text{C}$	All 1V8 (Y) All 1V2 (K) All		- - - -	0.3 0.1 0.1 0.3 -	0.6 0.4 0.4 0.7 1.0	%Vo
Ripple and Noise <sup>3</sup> Peak-to-Peak: (5Hz to 20MHz)	All	-	-	50	100	mVp-p
Output Current <sup>4</sup>	All	$I_O$	0	-	80	A
External Load Capacitance Capacitor ESR	All	-	- 4	- -	50,000 -	$\mu\text{F}$ $\text{m}\Omega$
Output Current-limit Inception $V_{OUT} = 90\% V_{O,SET}$ <sup>5</sup>	All	$I_O$	83	-	100	A
Over Voltage Protection Range <sup>6</sup>	1V8 (Y) 1V5 (M) 1V2 (K)		2.20 1.80 1.44	2.40 1.90 1.50	2.90 2.50 2.10	v
Over Temperature Range <sup>7</sup> (AVG PCB TEMPERATURE)	All		110	-	120	$^\circ\text{C}$
Efficiency $V_{IN} = V_{IN,NOM}$ ; $I_O = I_{O,MAX}$ $T_A = 25\text{ }^\circ\text{C}$	1V8 (Y) 1V5 (M) 1V2 (K)	$\eta$	86.0 84.5 82.0	87.0 85.5 83.0	- - -	% % %



## Technical Reference Notes AEH/ALH80 Series



### Electrical Specifications (continued)

#### OUTPUT SPECIFICATIONS

Parameter	Device	Symbol	Min	Typ	Max	Unit
Turn-On Response Time $I_O = I_{O,MAX}$ , $V_O$ within 1%	All	-	-	4	10	ms
Switching Frequency	All	-	360	400	440	KHz
Dynamic Response: $\Delta I_O / \Delta t = 0.1A / \mu S$ $C_O = 0\mu F$		-	-	0.1	-	A/ $\mu s$
Load Change from $I_O = 50\%$ to $75\%$ of $I_{O, Max}$ :	All	-	-	-	200	mV
Peak Deviation Settling Time to $V_{O, SET}$ tolerance		-	-	-	500	$\mu s$
Load Change from $I_O = 50\%$ to $25\%$ of $I_{O, Max}$ :	All	-	-	-	200	mV
Peak Deviation Settling Time to $V_{O, SET}$ tolerance		-	-	-	500	$\mu s$
Output Overshoot at T-on / T-off Passive Resistive Full Load	All	-	-	0	4	% $V_O$
Output Enable ON/OFF						
Negative Enable ("N" suffix) Enable Pin voltage for Module ON	N suffix	-	-0.7	-	1.2	V
Module OFF		-	2.95	-	10.0	V
Positive Enable (No suffix) Enable Pin voltage for Module ON	No suffix	-	2.95	-	10.0	V
Module OFF		-	-0.7	-	1.2	V
Output Voltage Remote Sensing <sup>8,10</sup>	All	-	-	-	10	% $V_O$
Output Voltage Trim Range <sup>9,10</sup>	All	-	90	-	110	% $V_O$

- Note:
3. See Figure 2 for Ripple and Noise test measurement setup. Output ripple may exceed max limits at high line condition.
  4. Appropriate Thermal Derating applies. See Figures 17 to 22 for the Thermal Derating Curves
  5. In an event of an over current condition - the converter will be latched off. Restart is possible either by cycling the input voltage or toggling the Enable signal for 100ms. Consult factory for Auto restart option.
  6. The OVP mode is latching. The converter will be latched off once the sensed voltage across the output pins exceeds the threshold limits. Restart is possible by either cycling the input voltage or toggling the Enable signal for 100ms. For testing purposes, output current should be derated so as not to exceed maximum output power.
  7. Output of the module will be terminated once the operating temp reaches the OTP range. Normal operation resumes once the temperature falls below the OTP range.
  8. The sense pins can be used to compensate for any voltage drops (per indicated max limits) that may occur along the connection between the output pins to the load. Pin 9 (+Sense) and Pin 7 (-Sense) should be connected to Pin 10/11 (+Vout) and Pin 5/6 (Return) respectively at the point where regulation is desired.
  9. Refer to Equation (1) and (2) and Figures 3 and 4 for the Output Trim Adjust configuration.
  10. The combination of remote sense and Trim adjust cannot exceed 110% of  $V_{O, NOM}$ .

### Electrical Specifications *(continued)*

#### **SAFETY APPROVAL**

The AEH80/ALH80 series have been certified through:

- UL + cUL 60950, Third Edition - Recognized (PENDING)
- EN 60950 through TUV-PS (PENDING)
- Meets Basic Insulation

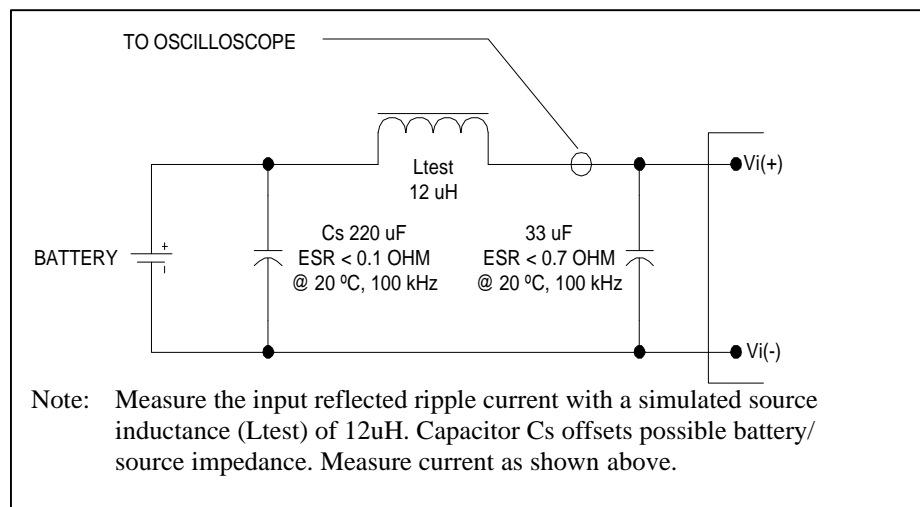

Figure 1. Input Reflected Ripple Current Measurement Setup.

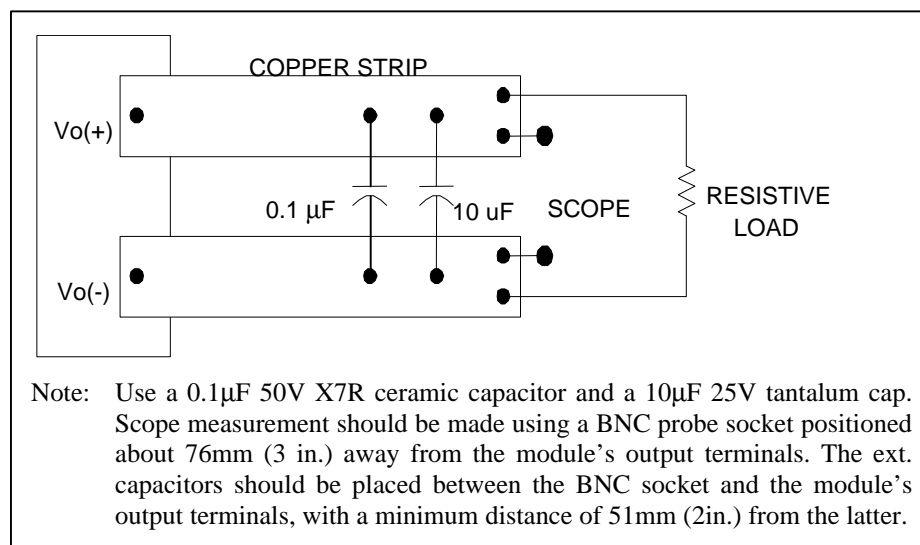

Figure 2. Peak to Peak Output Noise Measurement Setup.

## Basic Operation and Features

### INPUT UNDER VOLTAGE LOCKOUT

To prevent any instability to the converter, which may affect the end system, the AEH/ALH80 series have been designed to turn-on once  $V_{IN}$  is in the voltage range of 34-35.5 VDC. Likewise, it has also been programmed to turn-off when  $V_{IN}$  drops down to 32.5-34.5 VDC.

### OUTPUT VOLTAGE ADJUST/TRIM

The converter comes with a TRIM pin (PIN 8), which is used to adjust the output by as much as 90% to 110% of its set point. This is achieved by connecting an external resistor as described below.

To **INCREASE** the output, external  $R_{adj\_up}$  resistor should be connected between TRIM PIN (Pin8) and +SENSE PIN (Pin 7). Please refer to Equation (1) for the required external resistance and output adjust relationship.

**1.8V / 1.5V**

Equation (1a):

$$R_{adj\_up} = \left( \frac{V_o(100 + \Delta\%)}{1.225 \Delta\%} - \frac{100}{\Delta\%} - 2 \right) \cdot k\Omega$$

**1.2V**

Equation (1b):

$$R_{adj\_up} = \left( \frac{5.1 \cdot V_o(100 + \Delta\%)}{0.6 \Delta\%} - \frac{510}{\Delta\%} - 6.1 \right) \cdot k\Omega$$

To **DECREASE** the output, external  $R_{adj\_down}$  resistor should be connected between TRIM PIN (Pin 8) and -SENSE PIN (Pin 9). Please refer to Equation (2) for the required external resistance and output adjust relationship.

**1.8V / 1.5V**

Equation (2a)

$$R_{adj\_down} = \left( \frac{100}{\Delta\%} - 2 \right) \cdot k\Omega$$

**1.2V**

Equation (2b):

$$R_{adj\_down} = \left( \frac{510}{\Delta\%} - 6.1 \right) \cdot k\Omega$$

Where:  $R_{adj}$  = resistance in kohms  
? % = percent change in the output

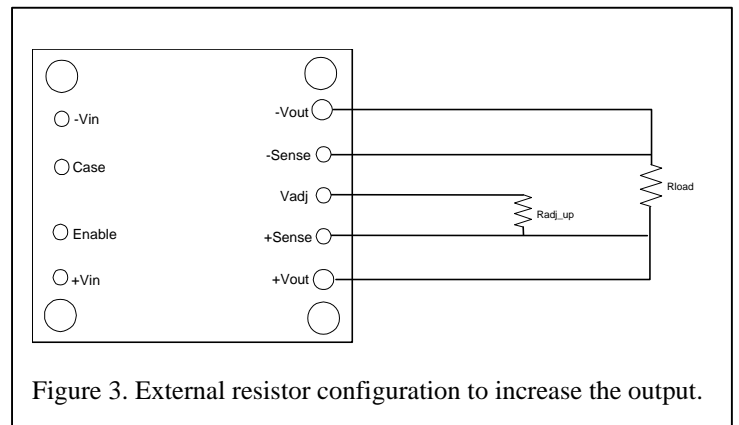

Figure 3. External resistor configuration to increase the output.

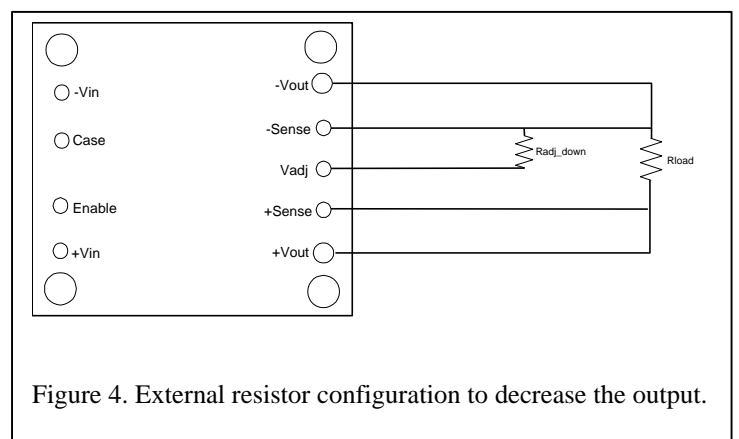

Figure 4. External resistor configuration to decrease the output.



## Technical Reference Notes AEH/ALH80 Series



---

### **Basic Operation and Features** *(continued)*

#### **OUTPUT ENABLE**

The AEH/ALH80 series comes with an Enable pin (PIN 2), which is primarily used to turn ON/OFF the converter. Both a Positive (no part number suffix required) and a Negative (suffix "N" required) Enable Logic options are being offered. Please refer to Table 2 for the Part Numbering Scheme.

For Positive Enable, the converter is turned on when the Enable pin is at logic HIGH or left open. The unit turns off when the Enable pin is at logic LOW or directly connected to  $-V_{IN}$ . On the other hand, the Negative Enable version turns unit on when the Enable pin is at logic LOW or directly connected to  $-V_{IN}$ . The unit turns off when the Enable pin is at Logic HIGH.

#### **OUTPUT OVER VOLTAGE PROTECTION (OVP)**

The Over Voltage Protection circuit comes in latching mode. The converter is latched off if the output voltage exceeds the OVP threshold limits. The OVP latch is reset either by cycling the input voltage or toggling the Enable signal for 100ms.

#### **OVER CURRENT PROTECTION (OCP)**

The Over Current Protection circuit comes in latching mode. The converter is latched off if the load current on the output reaches the OCP threshold limit. The OCP latch can be reset either by cycling the input voltage or toggling the Enable signal for 100ms. Consult factory for Auto-restart option.

#### **OVER TEMPERATURE PROTECTION (OTP)**

The Over Temperature Protection circuit will shutdown the converter once the average PCB temperature reaches the OTP range. This feature prevents the unit from overheating and consequently going into thermal runaway, which may further damage the converter and the end system. Such overheating may be an effect of operation outside the given power thermal derating conditions. Restart is possible once the temperature of the sensed location drops to less than  $110^{\circ}\text{C}$ .





## Performance Curves

### 1.8V SERIES

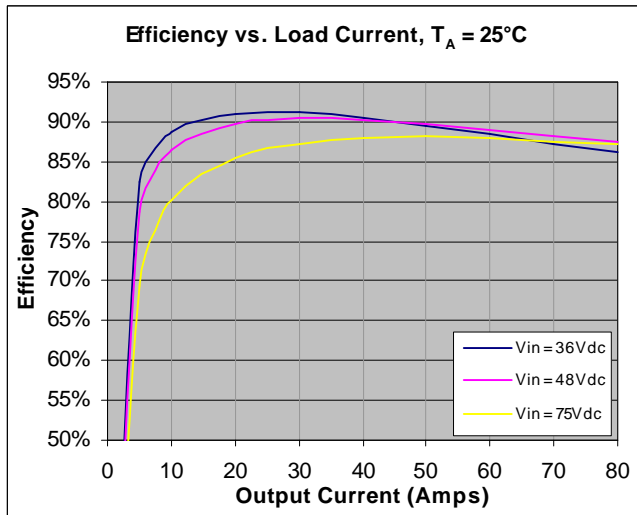

Figure 5. Efficiency vs. Load Current Curves at T<sub>A</sub>=25°C for different input voltages with 300 LFM airflow directed from Pins 4 to 1.

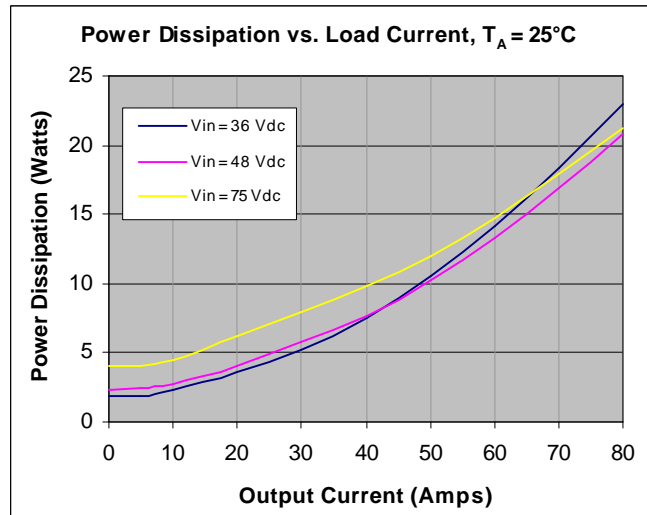

Figure 6. Power Dissipation vs. Load Current Curves at T<sub>A</sub>=25°C for different input voltages with 300 LFM airflow directed from Pins 4 to 1.

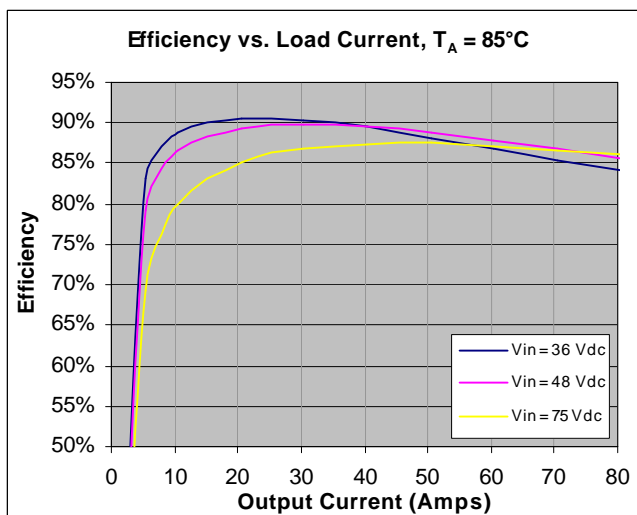

Figure 7. Efficiency vs. Load Current Curves at T<sub>A</sub>=85°C for different input voltages with 300 LFM airflow directed from Pins 4 to 1.

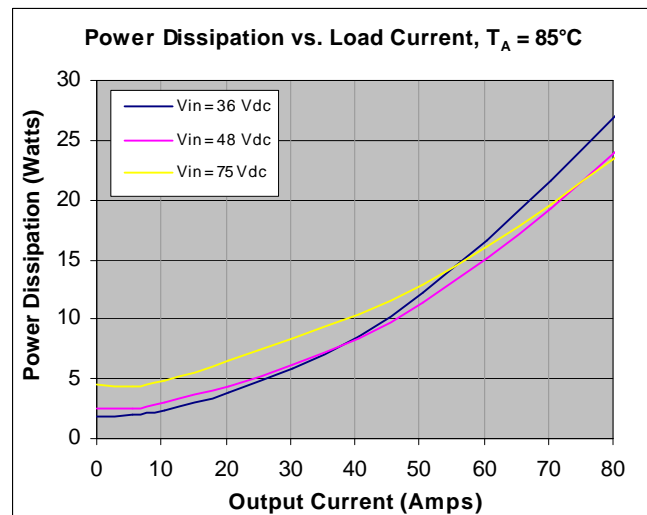

Figure 8. Power Dissipation vs. Load Current at T<sub>A</sub>=85°C for different input voltages with 300LFM airflow directed from Pins 4 to 1.



# Technical Reference Notes AEH/ALH80 Series



## Performance Curves (continued)

### 1.5V SERIES

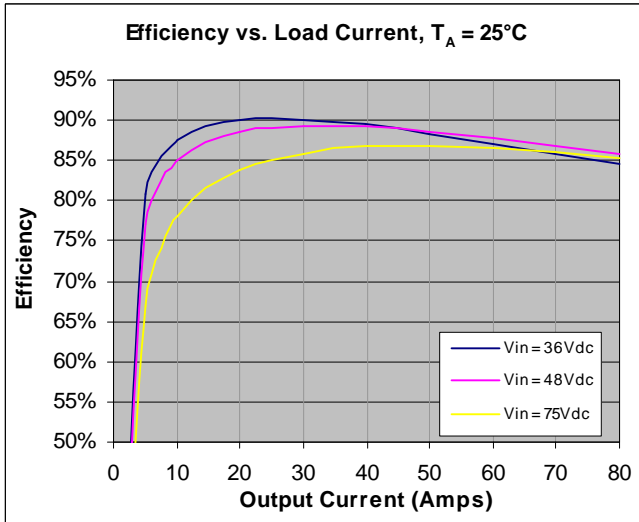

Figure 9. Efficiency vs. Load Current Curves at  $T_A=25^\circ\text{C}$  for different input voltages with 300 LFM airflow directed from Pins 4 to 1.

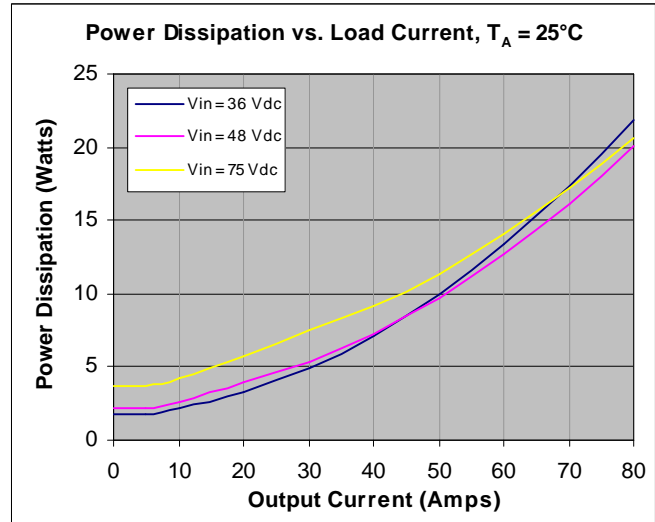

Figure 10. Power Dissipation vs. Load Current at  $T_A=25^\circ\text{C}$  for different input voltages with 300 LFM airflow directed from Pins 4 to 1.

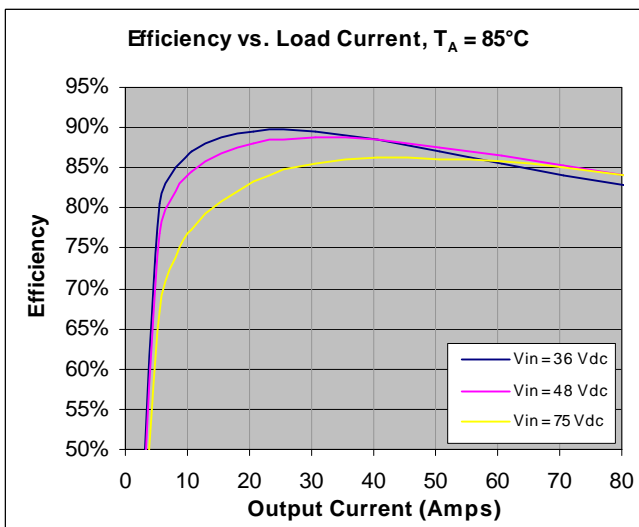

Figure 11. Efficiency vs. Load Current Curves at  $T_A=85^\circ\text{C}$  for different input voltages with 300 LFM airflow directed from Pins 4 to 1.

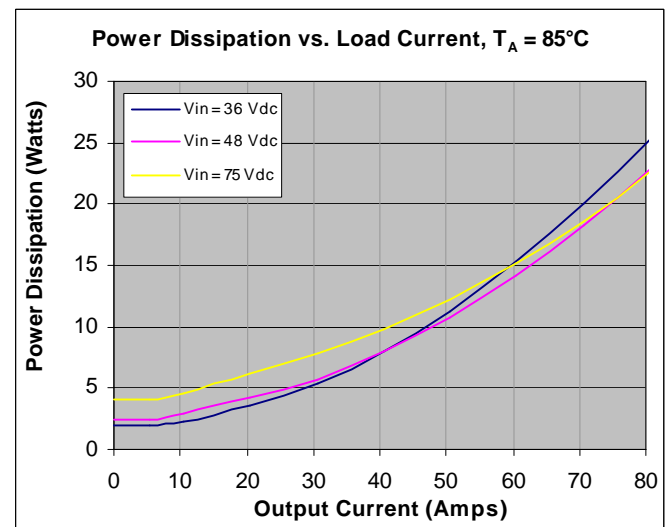

Figure 12. Power Dissipation vs. Load Current at  $T_A=85^\circ\text{C}$  for different input voltages with 300 LFM airflow directed from Pins 4 to 1.



**Performance Curves (continued)**

**1.2V SERIES**

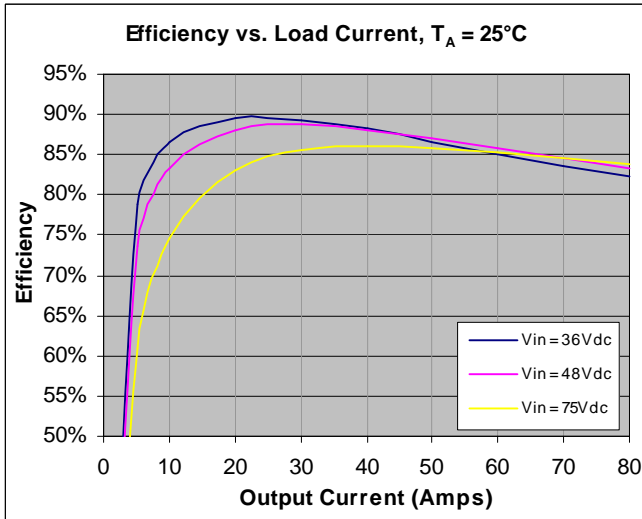

Figure 13. Efficiency vs. Load Current Curves at  $T_A=25^\circ\text{C}$  for different input voltages with 300 LFM airflow directed from Pins 4 to 1.

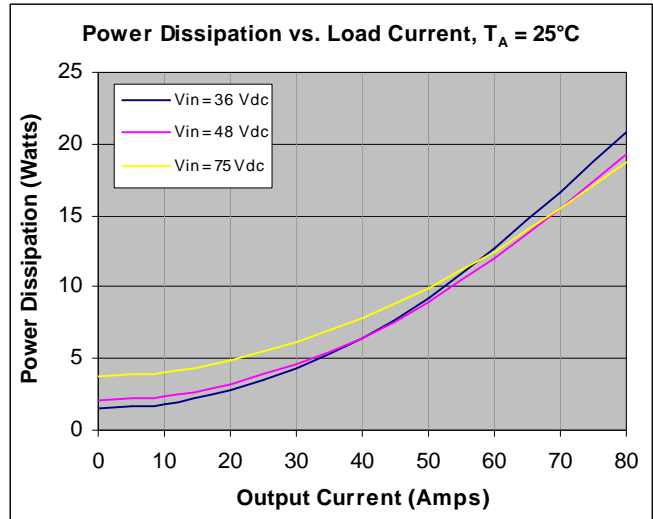

Figure 14. Power Dissipation vs. Load Current at  $T_A=25^\circ\text{C}$  for different input voltages with 300 LFM airflow directed from Pins 4 to 1.

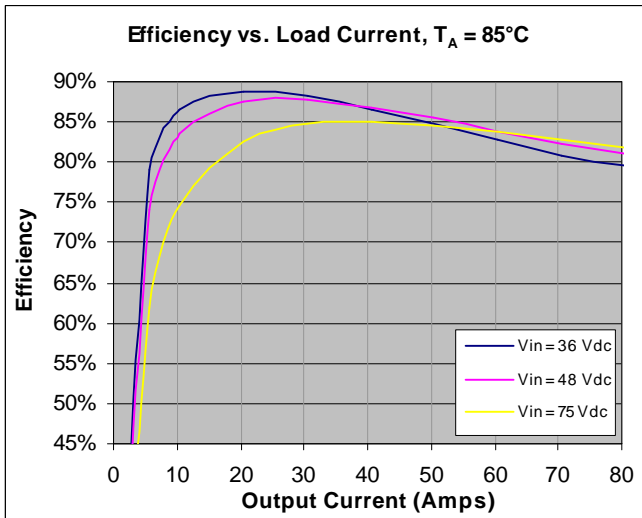

Figure 15. Efficiency vs. Load Current Curves at  $T_A=85^\circ\text{C}$  for different input voltages with 300 LFM airflow directed from Pins 4 to 1.

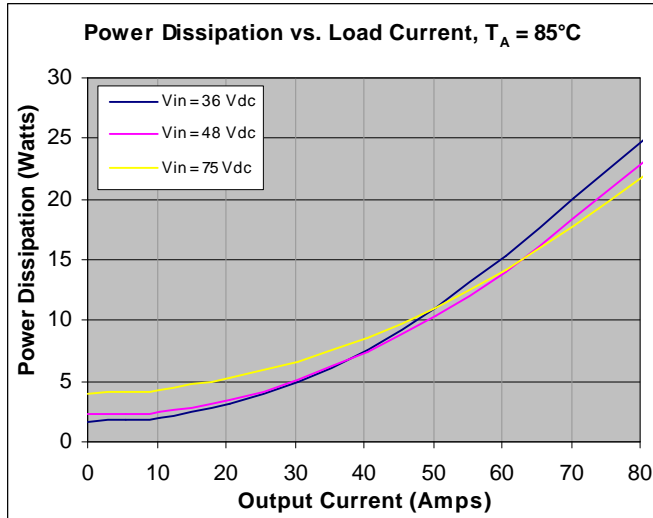

Figure 16. Power Dissipation vs. Load Current at  $T_A=85^\circ\text{C}$  for different input voltages with 300 LFM airflow directed from Pins 4 to 1.



**Performance Curves (continued)**

**CURRENT VS. TEMPERATURE CURVES**

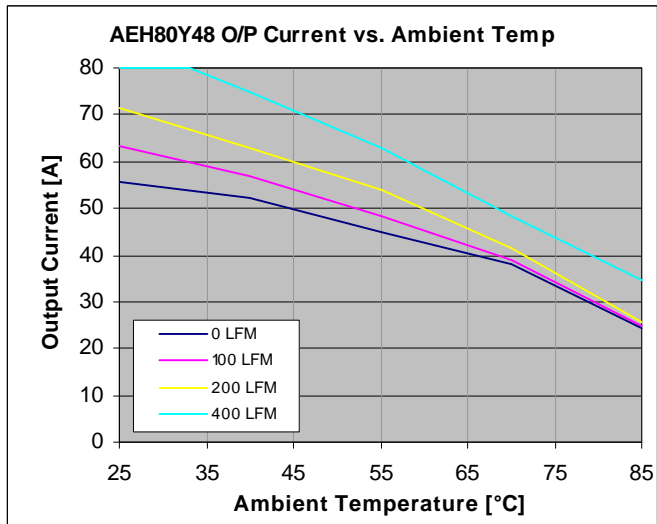

Figure 17. 1.8V Output Derating Curves (100°C Baseplate) at various airflow conditions directed across PIN 4 to 1 with the module mounted vertically.

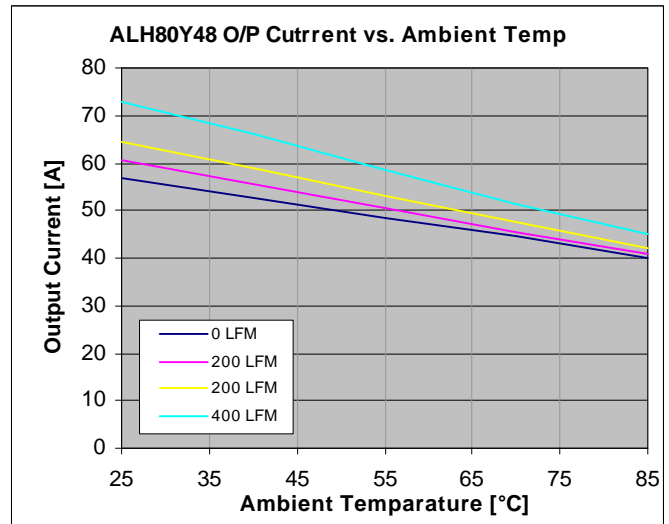

Figure 18. 1.8V Output Derating Curves (125°C Junction) at various airflow conditions directed across PIN 4 to 1 with the module mounted vertically.

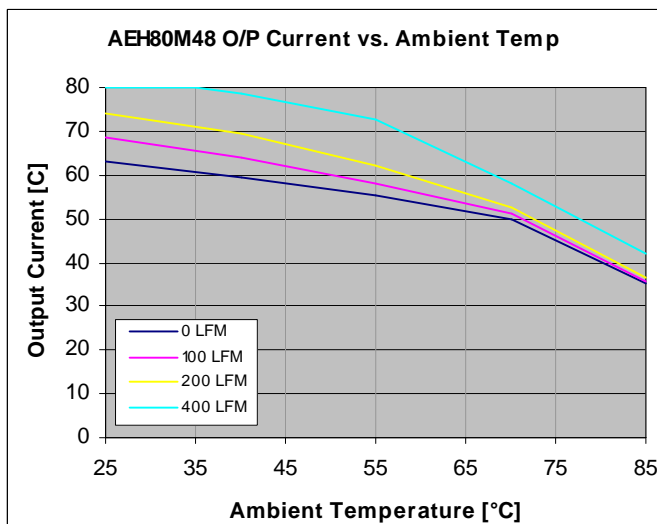

Figure 19. 1.5V Output Derating Curves (100°C Baseplate) at various airflow conditions directed across PIN 4 to 1 with the module mounted vertically.

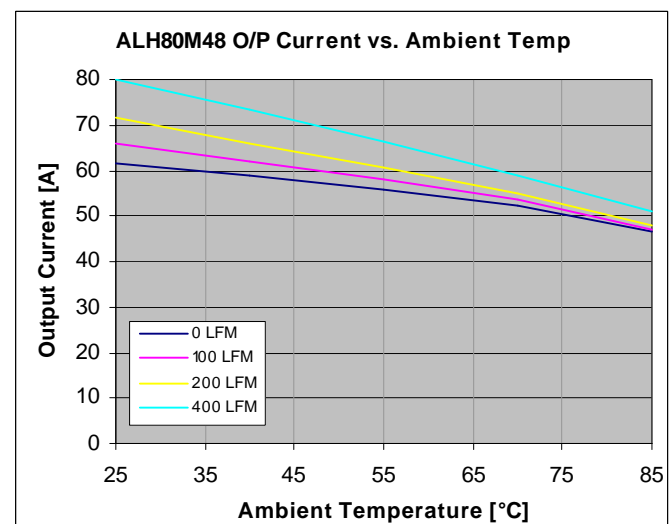

Figure 20. 1.5V Output Derating Curves (125°C Junction) at various airflow conditions directed across PIN 4 to 1 with the module mounted vertically.

**Performance Curves (continued)**

**CURRENT VS. TEMPERATURE CURVES**

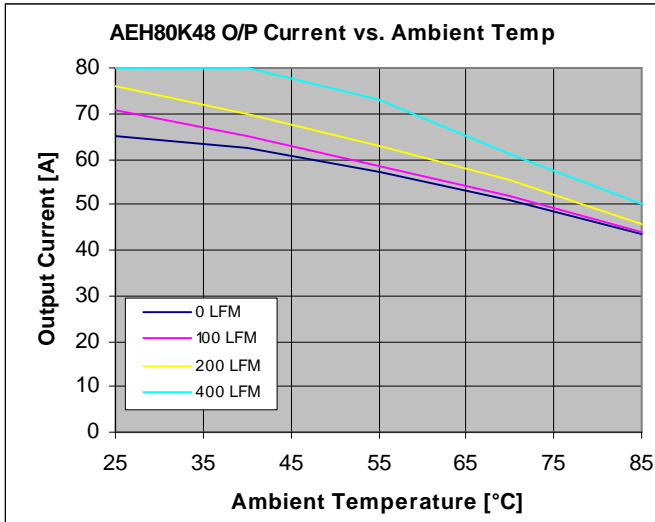

Figure 21. 1.2V Output Derating Curves (100°C Baseplate) at various airflow conditions directed across PIN 4 to 1 with the module mounted vertically.

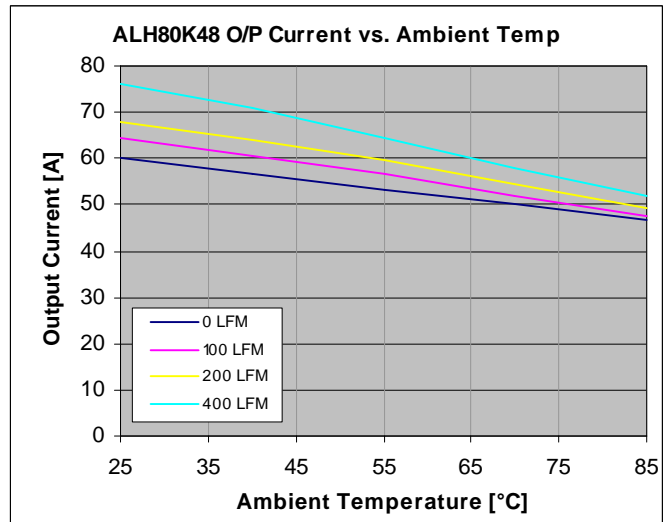

Figure 22. 1.2V Output Derating Curves (125°C Junction) at various airflow conditions directed across PIN 4 to 1 with the module mounted vertically.

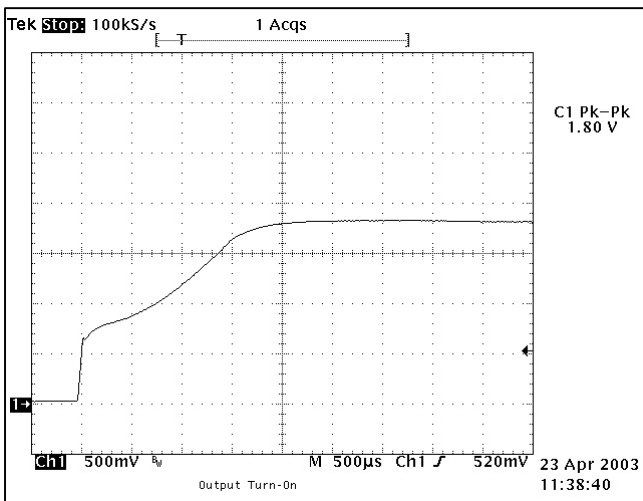

Figure 23. 1.8V Start-up characteristic at  $V_{IN} = 48Vdc$ , full load condition at  $T_A = 25^\circ C$ .

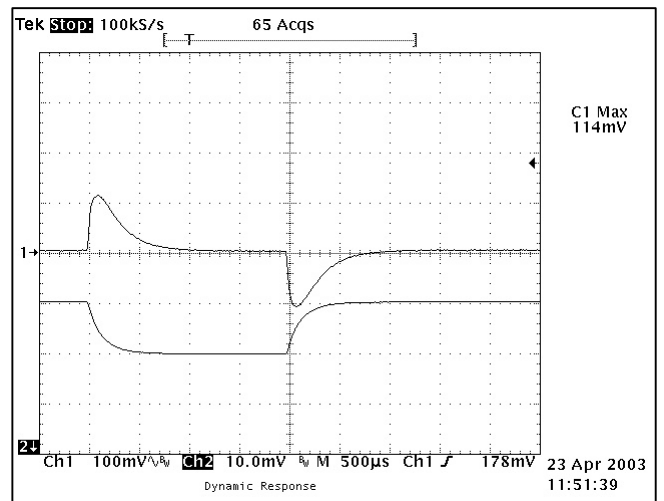

Figure 24. 1.8V transient load response for a 25%  $I_{O,MAX}$  (40-60-40A) load change at  $V_{IN} = 48Vdc$ ,  $T_A = 25^\circ C$ .



# Technical Reference Notes AEH/ALH80 Series



## Performance Curves (continued)

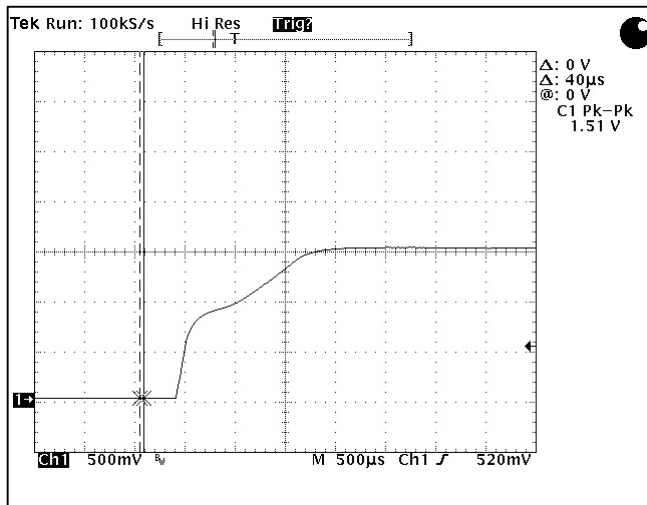

Figure 25. 1.5V Start-up characteristic at  $V_{IN} = 48\text{Vdc}$ , full load condition at  $T_A = 25^\circ\text{C}$ .

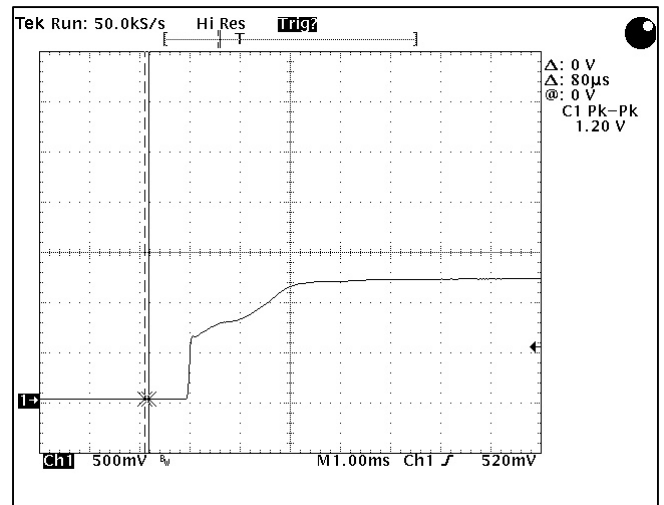

Figure 27. 1.2V Start-up characteristic at  $V_{IN} = 48\text{Vdc}$ , full load condition at  $T_A = 25^\circ\text{C}$ .

## Mechanical Specifications

Parameter	Device	Symbol	Min	Typ	Max	Unit
Dimension	All	L	-	2.40 [60.9]	-	in [ mm ]
		W	-	2.30 [58.4]	-	in [ mm ]
	AEH	H	-	0.50 [12.7]	-	in [ mm ]
	ALH	H	-	0.42 [10.6]	-	in [ mm ]
Weight	AEH		-	130 [4.6]	-	g [oz]
	ALH		-	110 [3.9]	-	g [oz]
PIN ASSIGNMENT						
<b>1</b>	+V <sub>IN</sub>			<b>7</b>	-SENSE	
<b>2</b>	Enable (On/Off)			<b>8</b>	TRIM	
<b>3</b>	Case			<b>9</b>	+SENSE	
<b>4</b>	-V <sub>IN</sub>			<b>10</b>	+V <sub>O</sub> [Optional Pin]	
<b>5</b>	-V <sub>O</sub>			<b>11</b>	+V <sub>O</sub>	
<b>6</b>	-V <sub>O</sub> [Optional Pin]					

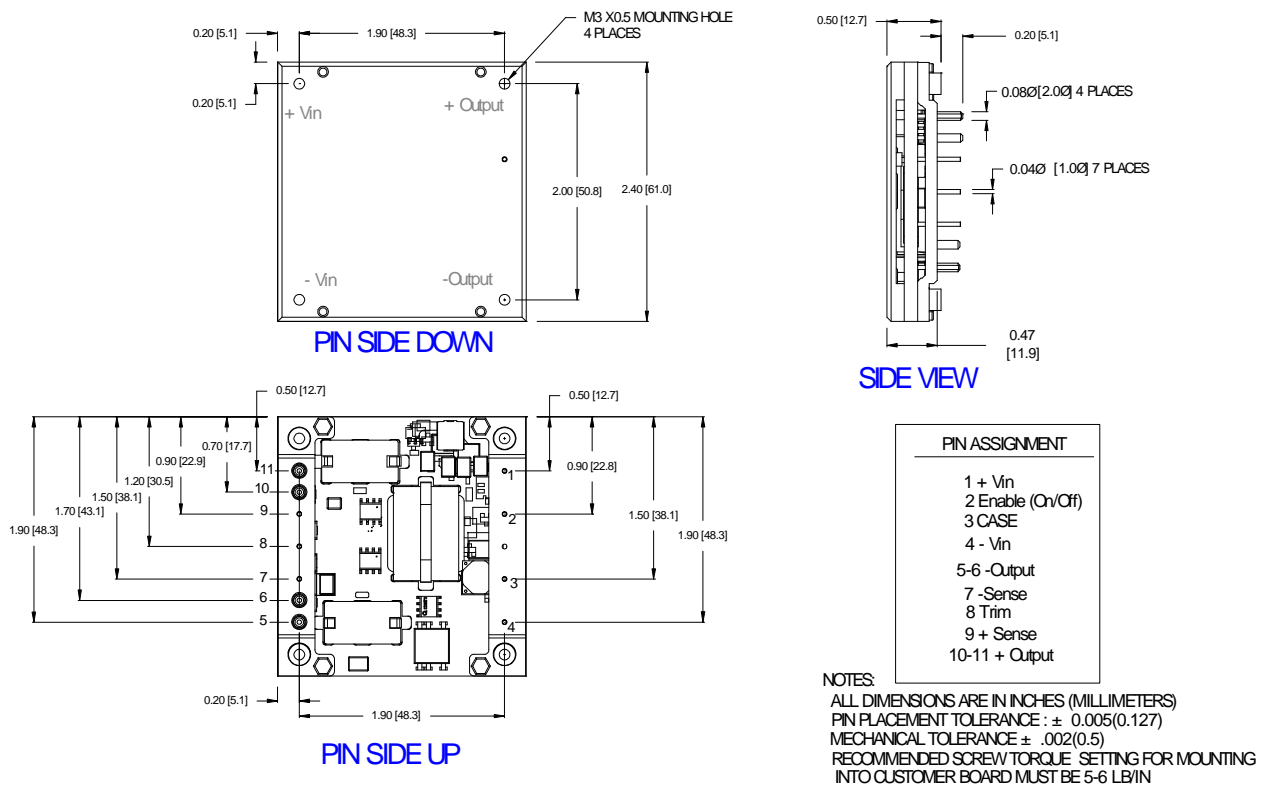

Figure 25. AEH80 Series (Baseplate) Mechanical Outline Drawing.

**Mechanical Specifications** (continued)

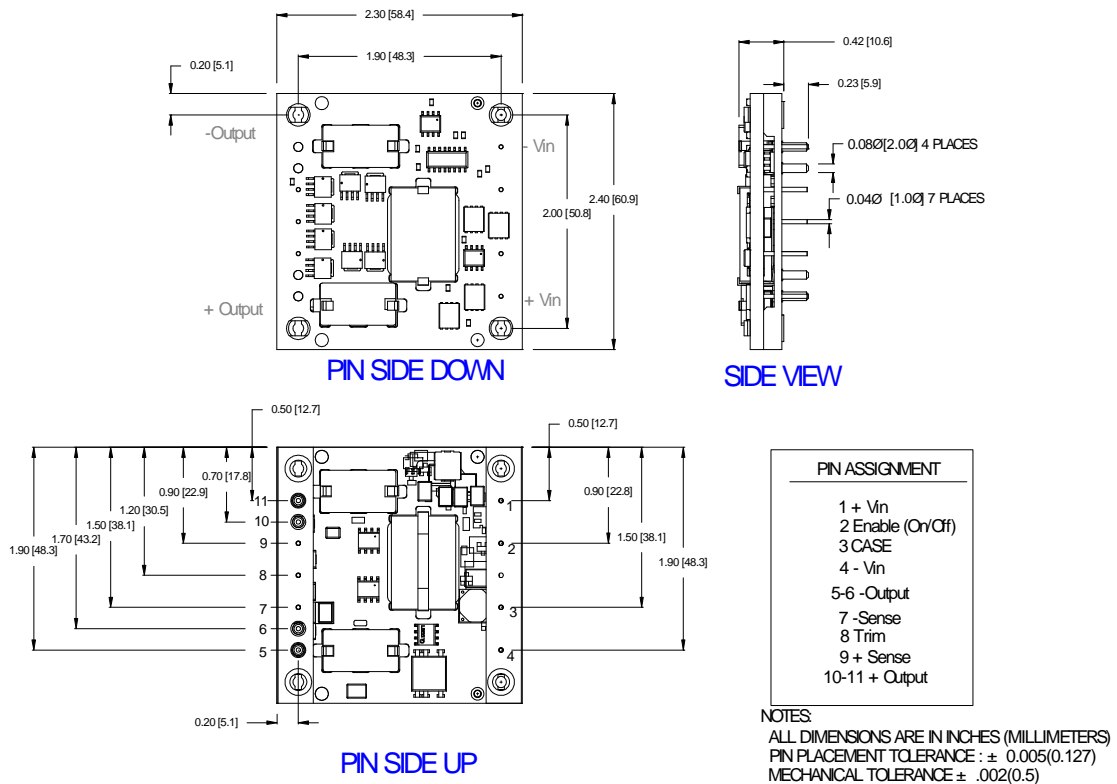

Figure 26. ALH80 Series (Open Frame) Mechanical Outline Drawing.

**SOLDERING CONSIDERATIONS**

The AEH/ALH80 series converters are compatible with standard wave soldering techniques. When wave soldering, the converter pins should be preheated for 20-30 seconds at 110°C and wave soldered at 260°C for less than 10 seconds.

When hand soldering, the iron temperature should be maintained at 425°C and applied to the converter pins for less than 5 seconds. Longer exposure can cause internal damage to the converter. Cleaning can be performed with cleaning solvent IPA or with water.





Technical Reference Notes  
AEH/ALH80 Series



**Mechanical Specifications** *(continued)*

**PART NUMBERING SCHEME FOR ORDERING**

	OUTPUT VOLTAGE	V <sub>IN</sub>	ENABLE LOGIC	OUTPUT PIN OPTION
<b>A</b> w <b>H80</b>	<b>x</b>	<b>48</b>	<b>y</b>	<b>z</b>
<b>E</b> = Baseplate <b>L</b> = Open Frame	<b>Y</b> = 1.8V <b>M</b> = 1.5V <b>K</b> = 1.2V		<b>N</b> = Negative Enable "Blank" = Positive Enable (Default)	"-3" = Single pair of output pins (delete Pins 6 and 10) "Blank" = 4 output pins (Pins 5, 6, 10, 11 present)

Please call 1-888-41-ASTEC for further inquiries  
or visit us at [www.astecpower.com](http://www.astecpower.com)