

SWITCHMODE™

NPN Bipolar Power Transistor

For Switching Power Supply Applications

The BUL147 have an applications specific state-of-the-art die designed for use in electric fluorescent lamp ballasts to 180 Watts and in Switchmode Power supplies for all types of electronic equipment. These high-voltage/high-speed transistors offer the following:

- Improved Efficiency Due to Low Base Drive Requirements:
 - High and Flat DC Current Gain
 - Fast Switching
 - No Coil Required in Base Circuit for Turn-Off (No Current Tail)
- Parametric Distributions are Tight and Consistent Lot-to-Lot
- Two Package Choices: Standard TO-220 or Isolated TO-220

MAXIMUM RATINGS

Rating	Symbol	BUL147	Unit
Collector-Emitter Sustaining Voltage	V_{CEO}	400	Vdc
Collector-Emitter Breakdown Voltage	V_{CES}	700	Vdc
Emitter-Base Voltage	V_{EBO}	9.0	Vdc
Collector Current — Continuous	I_C	8.0	Adc
— Peak(1)	I_{CM}	16	
Base Current — Continuous	I_B	4.0	Adc
— Peak(1)	I_{BM}	8.0	
Total Device Dissipation Derate above 25°C	P_D	125 1.0	Watts W/°C
Operating and Storage Temperature	T_J, T_{stg}	- 65 to 150	°C

THERMAL CHARACTERISTICS

Rating	Symbol	BUL44	Unit
Thermal Resistance — Junction to Case	$R_{\theta JC}$	1.0	°C/W
— Junction to Ambient	$R_{\theta JA}$	62.5	
Maximum Lead Temperature for Soldering Purposes: 1/8" from Case for 5 Seconds	T_L	260	°C

BUL147

POWER TRANSISTOR
8.0 AMPERES
700 VOLTS
45 and 125 WATTS

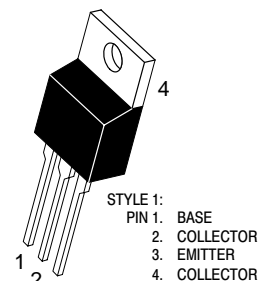

BUL147
CASE 221A-09
TO-220AB

BUL147

ELECTRICAL CHARACTERISTICS (T_C = 25°C unless otherwise noted)

Characteristic	Symbol	Min	Typ	Max	Unit
----------------	--------	-----	-----	-----	------

OFF CHARACTERISTICS

Collector–Emitter Sustaining Voltage (I _C = 100 mA, L = 25 mH)	V _{CEO(sus)}	400	—	—	Vdc
Collector Cutoff Current (V _{CE} = Rated V _{CEO} , I _B = 0)	I _{CEO}	—	—	100	μAdc
Collector Cutoff Current (V _{CE} = Rated V _{CES} , V _{EB} = 0)	I _{CES}	—	—	100	μAdc
		(T _C = 125°C)	—	500	
(V _{CE} = 500 V, V _{EB} = 0) (T _C = 125°C)		—	—	100	
Emitter Cutoff Current (V _{EB} = 9.0 Vdc, I _C = 0)	I _{EBO}	—	—	100	μAdc

ON CHARACTERISTICS

Base–Emitter Saturation Voltage (I _C = 2.0 Adc, I _B = 0.2 Adc)	V _{BE(sat)}	—	0.82	1.1	Vdc	
		(I _C = 4.5 Adc, I _B = 0.9 Adc)	0.92	1.25		
Collector–Emitter Saturation Voltage (I _C = 2.0 Adc, I _B = 0.2 Adc)	V _{CE(sat)}	—	0.25	0.5	Vdc	
		(T _C = 125°C)	—	0.3		
		(I _C = 4.5 Adc, I _B = 0.9 Adc)	—	0.35		0.7
			(T _C = 125°C)	—		0.35
DC Current Gain (I _C = 1.0 Adc, V _{CE} = 5.0 Vdc)	h _{FE}	14	—	34	—	
		—	30	—		
		(I _C = 4.5 Adc, V _{CE} = 1.0 Vdc)	8.0	12		—
		(T _C = 125°C)	7.0	11		—
		(I _C = 2.0 Adc, V _{CE} = 1.0 Vdc) (T _C = 25°C to 125°C)	10	18		—
(I _C = 10 mA, V _{CE} = 5.0 Vdc)	10	20	—			

DYNAMIC CHARACTERISTICS

Current Gain Bandwidth (I _C = 0.5 Adc, V _{CE} = 10 Vdc, f = 1.0 MHz)	f _T	—	14	—	MHz		
Output Capacitance (V _{CB} = 10 Vdc, I _E = 0, f = 1.0 MHz)	C _{ob}	—	100	175	pF		
Input Capacitance (V _{EB} = 8.0 V)	C _{ib}	—	1750	2500	pF		
Dynamic Saturation Voltage: Determined 1.0 μs and 3.0 μs respectively after rising I _{B1} reaches 90% of final I _{B1} (see Figure 18)	(I _C = 2.0 Adc I _{B1} = 200 mA V _{CC} = 300 V)	1.0 μs	(T _C = 125°C)	—	3.0	Volts	
		3.0 μs	(T _C = 125°C)	—	5.5		
		(I _C = 5.0 Adc I _{B1} = 0.9 Adc V _{CC} = 300 V)	1.0 μs	(T _C = 125°C)	—		0.8
			3.0 μs	(T _C = 125°C)	—		1.4
		V _{CE(dsat)}	—	—	3.3		—
			—	—	8.5		—
V _{CE(dsat)}	—	—	0.4	—			
	—	—	1.0	—			

(1) Pulse Test: Pulse Width = 5.0 ms, Duty Cycle ≤ 10%.

BUL147

SWITCHING CHARACTERISTICS: Resistive Load (D.C. ≤ 10%, Pulse Width = 20 μs)

Turn-On Time	(I _C = 2.0 Adc, I _{B1} = 0.2 Adc I _{B2} = 1.0 Adc, V _{CC} = 300 V) (T _C = 125°C)	t _{on}	— —	200 190	350 —	ns
Turn-Off Time		t _{off}	— —	1.0 1.6	2.5 —	μs
Turn-On Time	(I _C = 4.5 Adc, I _{B1} = 0.9 Adc I _{B1} = 2.25 Adc, V _{CC} = 300 V) (T _C = 125°C)	t _{on}	— —	85 100	150 —	ns
Turn-Off Time		t _{off}	— —	1.5 2.0	2.5 —	μs

SWITCHING CHARACTERISTICS: Inductive Load (V_{clamp} = 300 V, V_{CC} = 15 V, L = 200 μH)

Fall Time	(I _C = 2.0 Adc, I _{B1} = 0.2 Adc I _{B2} = 1.0 Adc) (T _C = 125°C)	t _{fi}	— —	100 120	180 —	ns
Storage Time		t _{si}	— —	1.3 1.9	2.5 —	μs
Crossover Time		t _c	— —	210 230	350 —	ns
Fall Time	(I _C = 4.5 Adc, I _{B1} = 0.9 Adc I _{B2} = 2.25 Adc) (T _C = 125°C)	t _{fi}	— —	80 100	150 —	ns
Storage Time		t _{si}	— —	1.6 2.1	3.2 —	μs
Crossover Time		t _c	— —	170 200	300 —	ns
Fall Time	(I _C = 4.5 Adc, I _{B1} = 0.9 Adc I _{B2} = 0.9 Adc) (T _C = 125°C)	t _{fi}	60 —	— 150	180 —	ns
Storage Time		t _{si}	2.6 —	— 4.3	3.8 —	μs
Crossover Time		t _c	— —	200 330	350 —	ns

TYPICAL STATIC CHARACTERISTICS

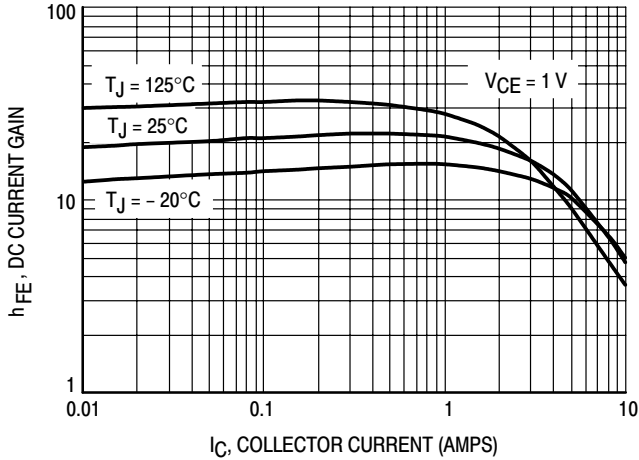

Figure 1. DC Current Gain @ 1 Volt

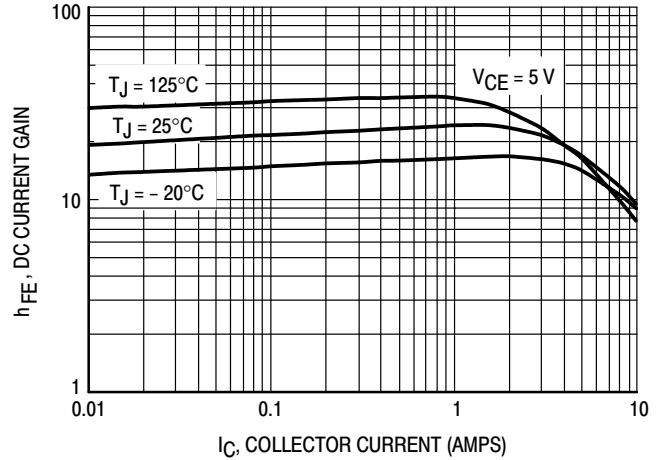

Figure 2. DC Current Gain @ 5 Volts

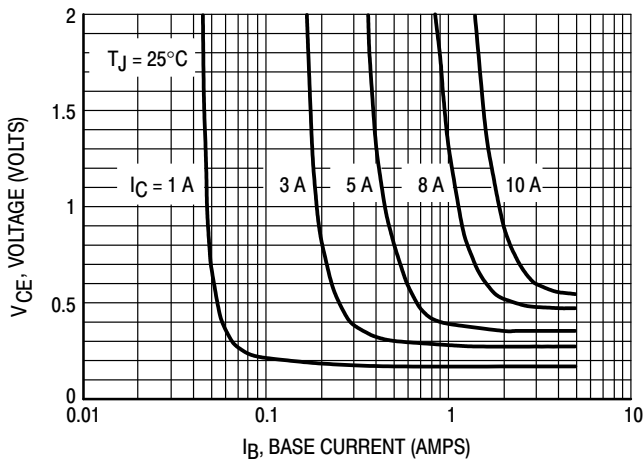

Figure 3. Collector Saturation Region

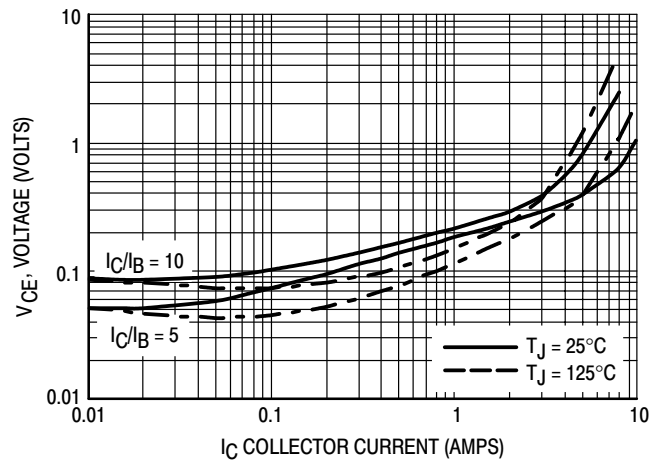

Figure 4. Collector-Emitter Saturation Voltage

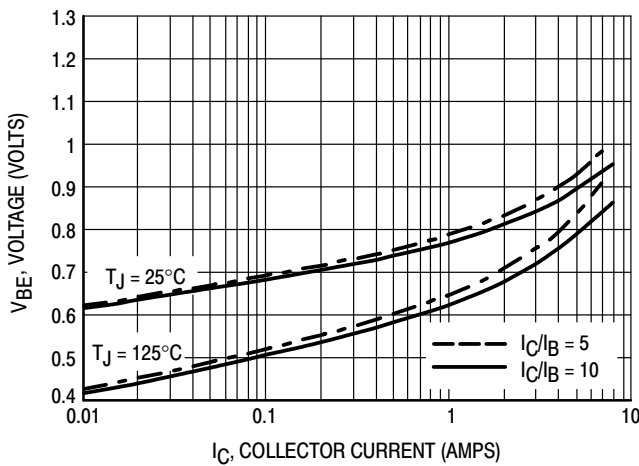

Figure 5. Base-Emitter Saturation Region

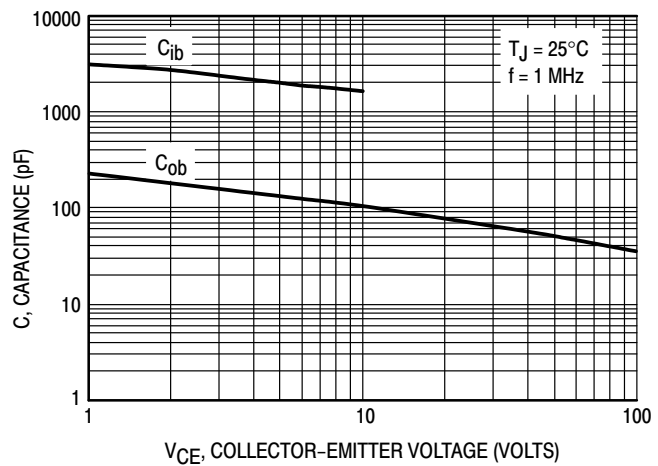

Figure 6. Capacitance

TYPICAL SWITCHING CHARACTERISTICS
($I_B = I_C/2$ for all switching)

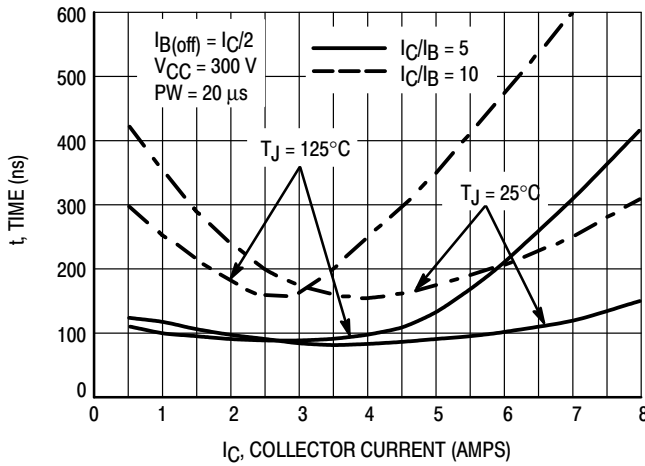

Figure 7. Resistive Switching, t_{on}

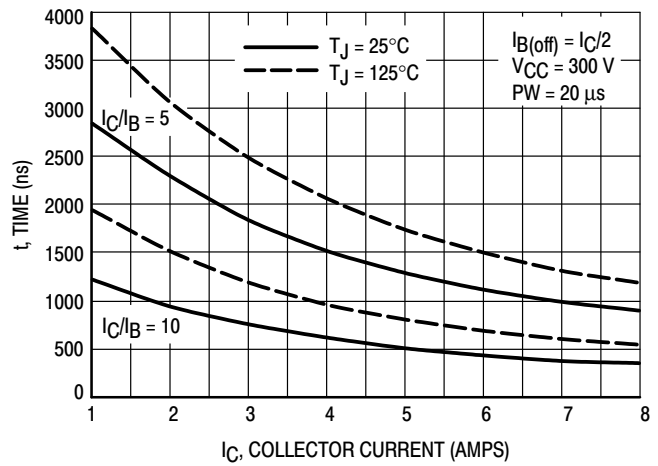

Figure 8. Resistive Switching, t_{off}

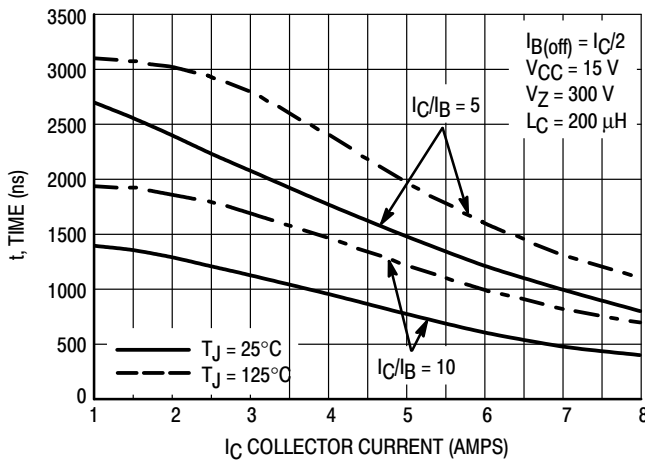

Figure 9. Inductive Storage Time, t_{si}

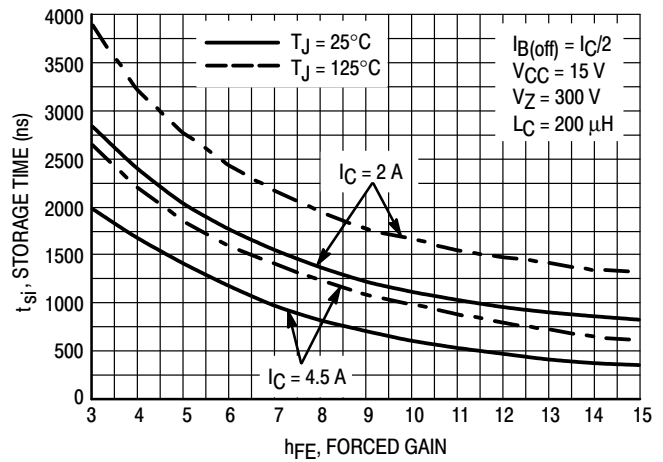

Figure 10. Inductive Storage Time, $t_{si}(h_{FE})$

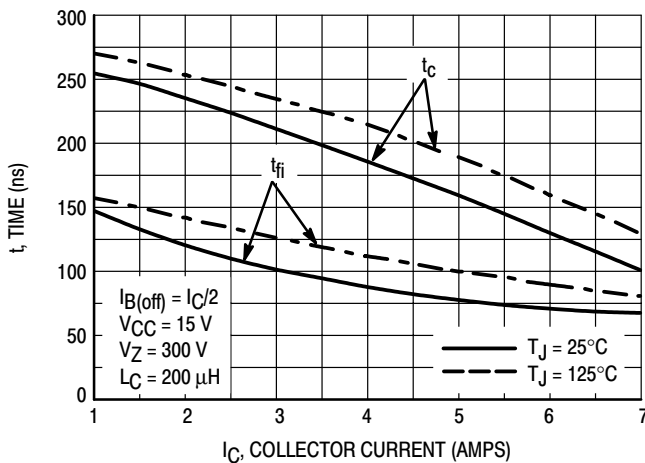

Figure 11. Inductive Switching, t_c and t_{fi}
 $I_C/I_B = 5$

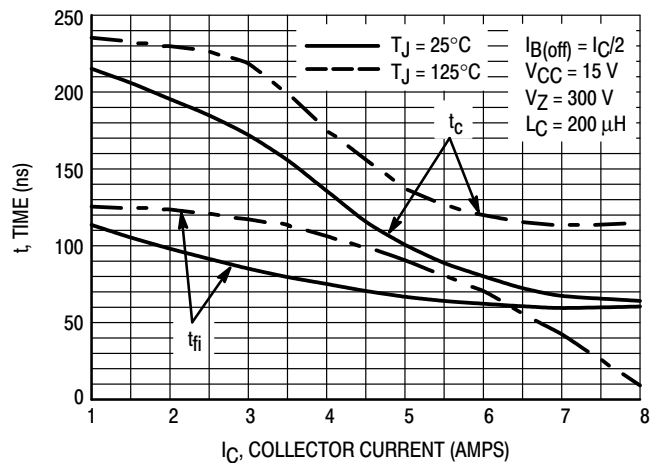

Figure 12. Inductive Switching, t_c and t_{fi}
 $I_C/I_B = 10$

TYPICAL SWITCHING CHARACTERISTICS
($I_{B2} = I_C/2$ for all switching)

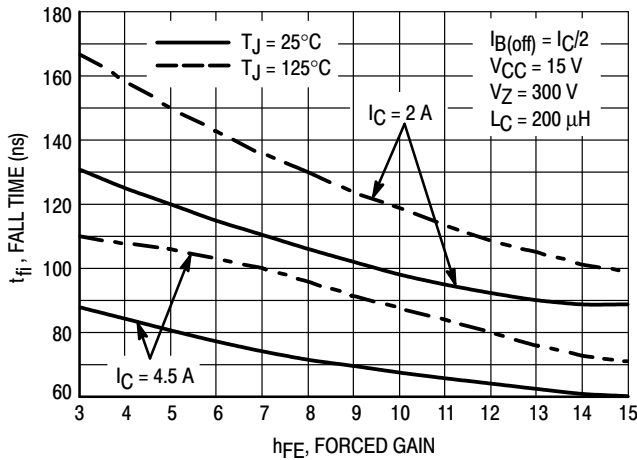

Figure 13. Inductive Fall Time

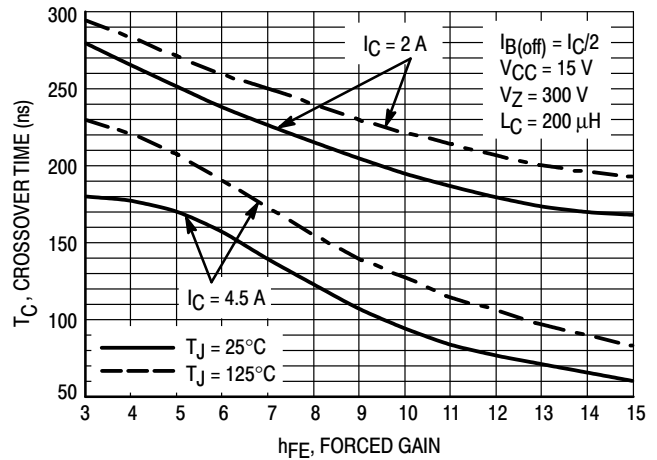

Figure 14. Inductive Crossover Time

GUARANTEED SAFE OPERATING AREA INFORMATION

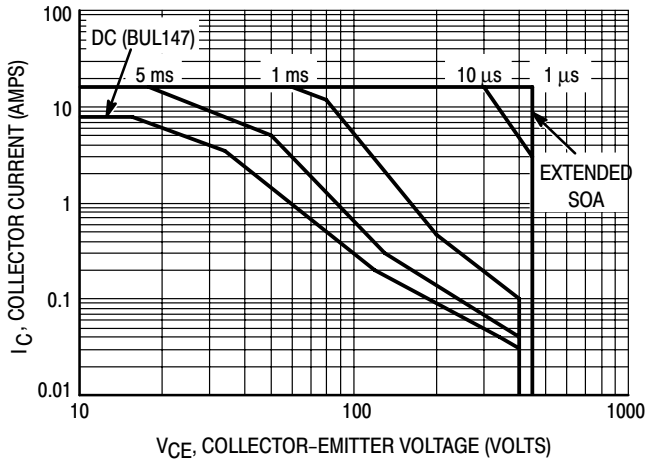

Figure 15. Forward Bias Safe Operating Area

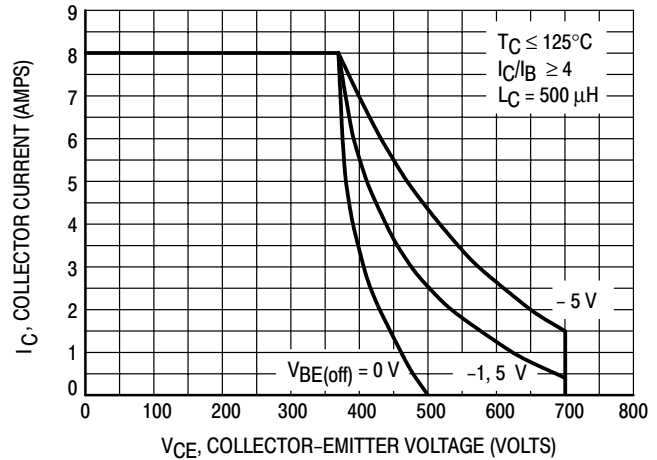

Figure 16. Reverse Bias Switching Safe Operating Area

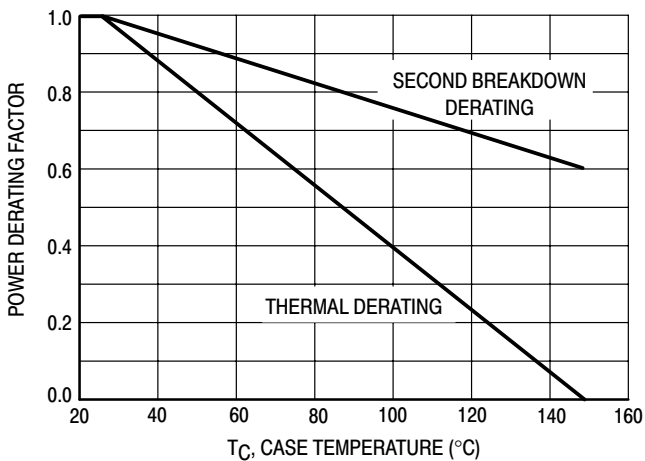

Figure 17. Forward Bias Power Derating

There are two limitations on the power handling ability of a transistor: average junction temperature and second breakdown. Safe operating area curves indicate $I_C - V_{CE}$ limits of the transistor that must be observed for reliable operation; i.e., the transistor must not be subjected to greater dissipation than the curves indicate. The data of Figure 15 is based on $T_C = 25^\circ\text{C}$; $T_{J(pk)}$ is variable depending on power level. Second breakdown pulse limits are valid for duty cycles to 10% but must be derated when $T_C > 25^\circ\text{C}$. Second breakdown limitations do not derate the same as thermal limitations. Allowable current at the voltages shown in Figure 15 may be found at any case temperature by using the appropriate curve on Figure 17. $T_{J(pk)}$ may be calculated from the data in Figure 20 and NO TAG. At any case temperatures, thermal limitations will reduce the power that can be handled to values less than the limitations imposed by second breakdown. For inductive loads, high voltage and current must be sustained simultaneously during turn-off with the base-to-emitter junction reverse-biased. The safe level is specified as a reverse-biased safe operating area (Figure 16). This rating is verified under clamped conditions so that the device is never subjected to an avalanche mode.

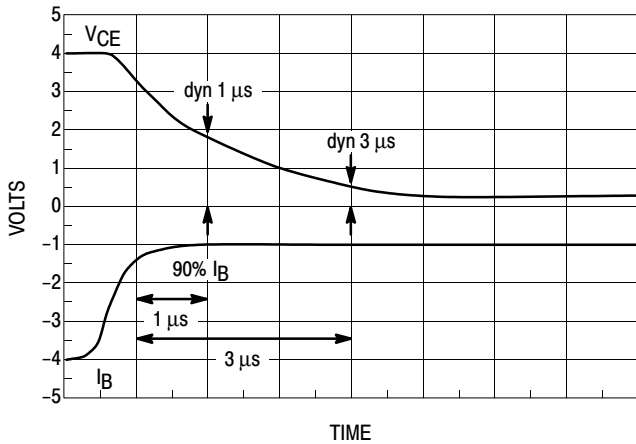

Figure 18. Dynamic Saturation Voltage Measurements

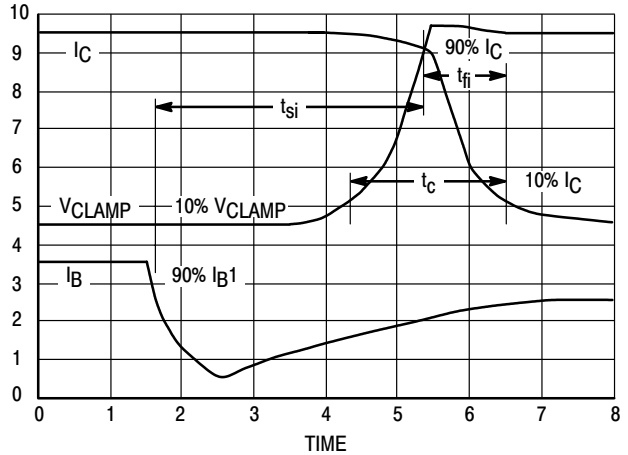
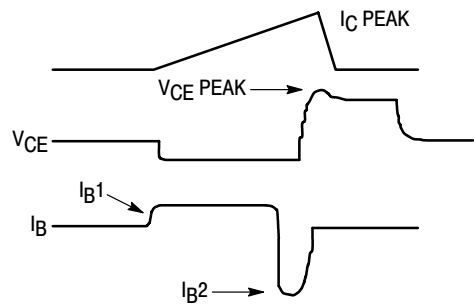
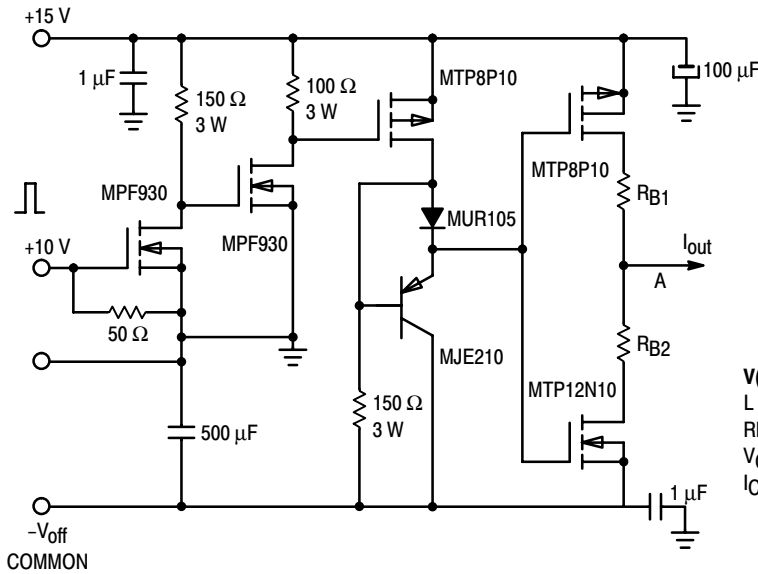

Figure 19. Inductive Switching Measurements



V(BR)CEO(sus)	INDUCTIVE SWITCHING	RBSOA
L = 10 mH	L = 200 μH	L = 500 μH
RB2 = ∞	RB2 = 0	RB2 = 0
VCC = 20 VOLTS	VCC = 15 VOLTS	VCC = 15 VOLTS
IC(pk) = 100 mA	RB1 SELECTED FOR DESIRED IB1	RB1 SELECTED FOR DESIRED IB1

Table 1. Inductive Load Switching Drive Circuit

TYPICAL THERMAL RESPONSE

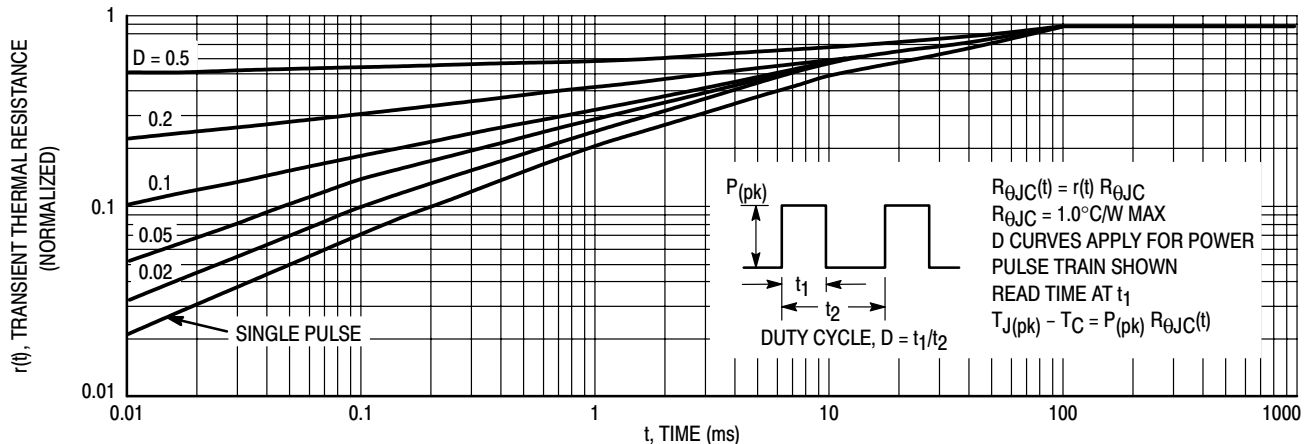
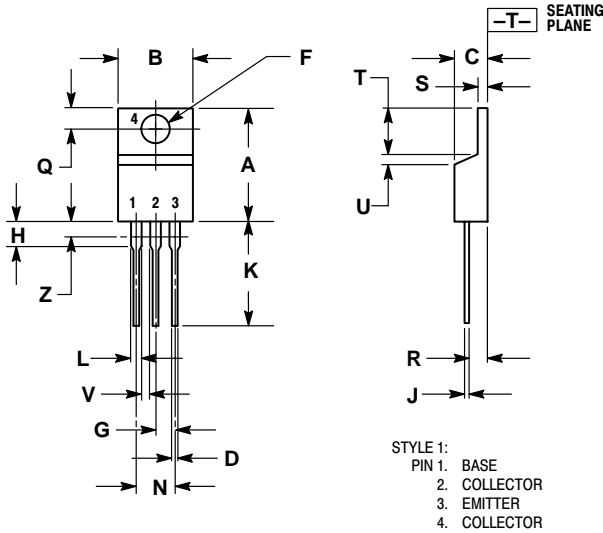

Figure 20. Typical Thermal Response ($Z_{\theta JC}(t)$) for BUL147

BUL147

PACKAGE DIMENSIONS

TO-220AB CASE 221A-09 ISSUE AA



NOTES:

1. DIMENSIONING AND TOLERANCING PER ANSI Y14.5M, 1982.
2. CONTROLLING DIMENSION: INCH.
3. DIMENSION Z DEFINES A ZONE WHERE ALL BODY AND LEAD IRREGULARITIES ARE ALLOWED.

DIM	INCHES		MILLIMETERS	
	MIN	MAX	MIN	MAX
A	0.570	0.620	14.48	15.75
B	0.380	0.405	9.66	10.28
C	0.160	0.190	4.07	4.82
D	0.025	0.035	0.64	0.88
F	0.142	0.147	3.61	3.73
G	0.095	0.105	2.42	2.66
H	0.110	0.155	2.80	3.93
J	0.018	0.025	0.46	0.64
K	0.500	0.562	12.70	14.27
L	0.045	0.060	1.15	1.52
N	0.190	0.210	4.83	5.33
Q	0.100	0.120	2.54	3.04
R	0.080	0.110	2.04	2.79
S	0.045	0.055	1.15	1.39
T	0.235	0.255	5.97	6.47
U	0.000	0.050	0.00	1.27
V	0.045	---	1.15	---
Z	---	0.080	---	2.04

SWITCHMODE is a trademark of Semiconductor Components Industries, LLC.

ON Semiconductor and  are registered trademarks of Semiconductor Components Industries, LLC (SCILLC). SCILLC reserves the right to make changes without further notice to any products herein. SCILLC makes no warranty, representation or guarantee regarding the suitability of its products for any particular purpose, nor does SCILLC assume any liability arising out of the application or use of any product or circuit, and specifically disclaims any and all liability, including without limitation special, consequential or incidental damages. "Typical" parameters which may be provided in SCILLC data sheets and/or specifications can and do vary in different applications and actual performance may vary over time. All operating parameters, including "Typicals" must be validated for each customer application by customer's technical experts. SCILLC does not convey any license under its patent rights nor the rights of others. SCILLC products are not designed, intended, or authorized for use as components in systems intended for surgical implant into the body, or other applications intended to support or sustain life, or for any other application in which the failure of the SCILLC product could create a situation where personal injury or death may occur. Should Buyer purchase or use SCILLC products for any such unintended or unauthorized application, Buyer shall indemnify and hold SCILLC and its officers, employees, subsidiaries, affiliates, and distributors harmless against all claims, costs, damages, and expenses, and reasonable attorney fees arising out of, directly or indirectly, any claim of personal injury or death associated with such unintended or unauthorized use, even if such claim alleges that SCILLC was negligent regarding the design or manufacture of the part. SCILLC is an Equal Opportunity/Affirmative Action Employer.

PUBLICATION ORDERING INFORMATION

Literature Fulfillment:

Literature Distribution Center for ON Semiconductor
P.O. Box 5163, Denver, Colorado 80217 USA
Phone: 303-675-2175 or 800-344-3860 Toll Free USA/Canada
Fax: 303-675-2176 or 800-344-3867 Toll Free USA/Canada
Email: ONlit@hibbertco.com

N. American Technical Support: 800-282-9855 Toll Free USA/Canada

JAPAN: ON Semiconductor, Japan Customer Focus Center
4-32-1 Nishi-Gotanda, Shinagawa-ku, Tokyo, Japan 141-0031
Phone: 81-3-5740-2700
Email: r14525@onsemi.com

ON Semiconductor Website: <http://onsemi.com>

For additional information, please contact your local Sales Representative.