

# Chip Bead (CIB/CIM Series)



CIB, CIM Series are used for EMI suppression filters. These beads suppress EMI noise by increased impedance, especially by increased resistance at noise frequency. CIB series is composed of mono-layer internal conductor that allows low impedance and low DC resistance.

CIM Series displays high impedance because it is composed of a multi-layered internal conductor and has excellent attenuation characteristics for wide band frequencies

## General Features

- Smallest inductors suitable for surface mounting
- Perfect shape for automatic mounting, with no directionality
- Excellent solderability and high heat resistance for either flow or reflow soldering
- Monolithic inorganic material construction for high reliability
- Closed magnetic circuit configuration avoids crosstalk and is suitable for high density PCBs.

## Applications

- High frequency EMI prevention application applicable to computers, printers, VCRs, TVs and portable telephones

## Part Numbering

<u>CI</u>	<u>M</u>	<u>10</u>	<u>J</u>	<u>121</u>	<u>N</u>	<u>C</u>
①	②	③	④	⑤	⑥	⑦

### ① SAMSUNG MULTILAYER CHIP INDUCTOR/BEADS

### ② SERIES CODE

CODE	DESCRIPTION OF CODE
B	Mono-layer type Normal Bead
M	Multi-layer type Normal Bead

### ③ DIMENSION

CODE	DIMENSION(L×W)
05	1.0×0.5
10	1.6×0.8
21	2.0×1.25
31	3.2×1.6
32	3.2×2.5
41	4.5×1.6
43	4.5×3.2

### ④ MATERIAL CODE

CODE	DESCRIPTION OF CODE
P,U	Broad impedance, especially suppresses noise in the 10~200MHz range
J	Suppresses noise in the 100~300MHz range
K	Suppresses noise in the 200MHz above
N	Suppresses noise in the 200~500MHz range

### ⑤ NOMINAL IMPEDANCE

There are three digits representing impedance. The first 2 digits are showing figures and the other one is for the number of zero.

example)

CODE	IMPEDANCE
601	$60 \times 10^1 = 600 \Omega$
100	$10 \times 10^0 = 10 \Omega$

## 6 THICKNESS OPTION

CODE	DESCRIPTION OF CODE
N	Standard thickness
A	Thinner than standard thickness
B	Thicker than standard thickness
V	Internally vertical electrode structure

## 7 PACKAGE TYPE

CODE	DESCRIPTION OF CODE
C	Paper taping type
E	Embossed (Plastic) taping type

## APPEARANCE AND DIMENSION

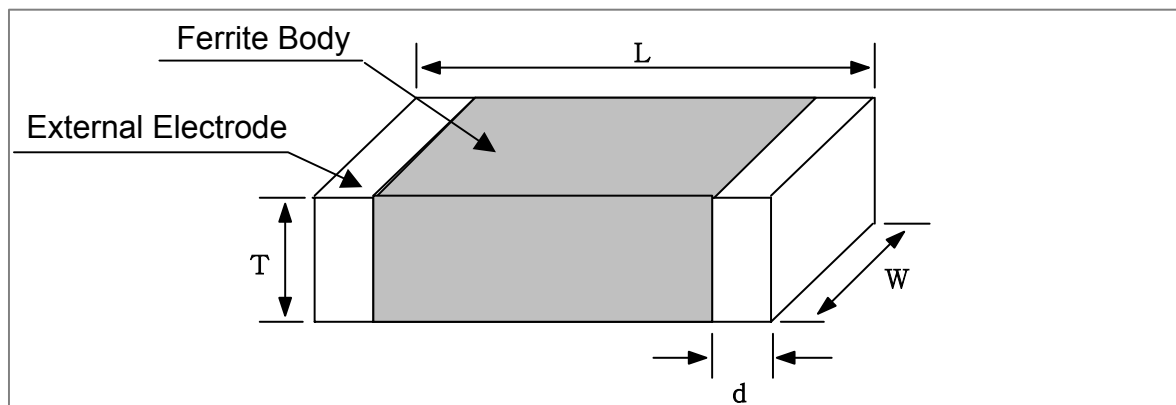

SIZE CODE	L	W	t	d
05	$1.0 \pm 0.05$	$0.5 \pm 0.05$	$0.5 \pm 0.05$	$0.25 \pm 0.1$
10	$1.6 \pm 0.15$	$0.8 \pm 0.15$	$0.8 \pm 0.15$	$0.3 \pm 0.2$
21	$2.0 \pm 0.2$	$1.25 \pm 0.2$	$0.9 \pm 0.2$	$0.5+0.2,-0.3$
31	$3.2 \pm 0.2$	$1.6 \pm 0.2$	$1.1 \pm 0.2$	$0.5+0.2,-0.3$
32	$3.2 \pm 0.2$	$2.5 \pm 0.2$	$1.3 \pm 0.2$	$0.5 \pm 0.3$
41	$4.5 \pm 0.2$	$1.6 \pm 0.2$	$1.6 \pm 0.2$	$0.5 \pm 0.3$
43	$4.5 \pm 0.2$	$3.2 \pm 0.2$	$1.5 \pm 0.2$	$0.5 \pm 0.3$

## CHARACTERISTIC LINE UP

### ● CIM 1005(0402) Type

Part No.	Thickness [mm]	Impedance [Ω]± 25% @100MHz	DC Resistance [Ω] MAX	Rated Current [mA] MAX
CIM 05U 100	0.5 ± 0.05	10	0.05	1200
CIM 05U 300	0.5 ± 0.05	30	0.2	700
CIM 05U 600	0.5 ± 0.05	60	0.2	600
CIM 05U 800	0.5 ± 0.05	80	0.25	600
CIM 05U 121	0.5 ± 0.05	120	0.3	500
CIM 05U 241	0.5 ± 0.05	240	0.35	400
CIM 05U 301	0.5 ± 0.05	300	0.45	400
CIM 05U 471	0.5 ± 0.05	470	0.55	300
CIM 05U 601	0.5 ± 0.05	600	0.6	300
CIM 05U 102	0.5 ± 0.05	1000	1.3	250
CIM 05J 300	0.5 ± 0.05	30	0.2	700
CIM 05J 600	0.5 ± 0.05	60	0.2	600
CIM 05J 800	0.5 ± 0.05	80	0.25	600
CIM 05J 121	0.5 ± 0.05	120	0.3	500
CIM 05J 241	0.5 ± 0.05	240	0.35	400
CIM 05J 301	0.5 ± 0.05	300	0.45	400
CIM 05J 471	0.5 ± 0.05	470	0.55	300
CIM 05J 601	0.5 ± 0.05	600	0.6	300
CIM 05J 102	0.5 ± 0.05	1000	0.8	250
CIM 05J 152	0.5 ± 0.05	1500	1.0	250

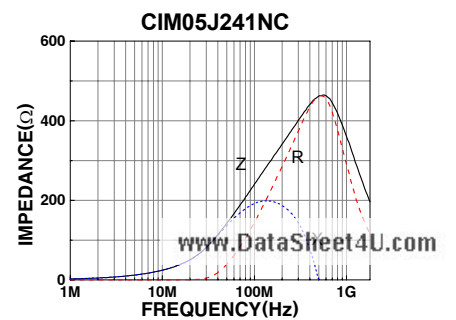
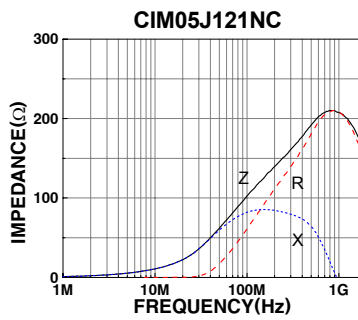
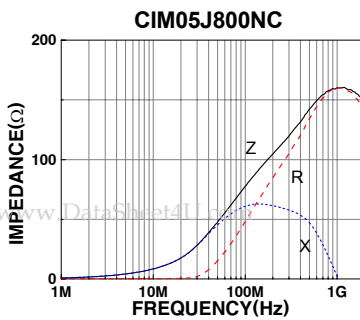
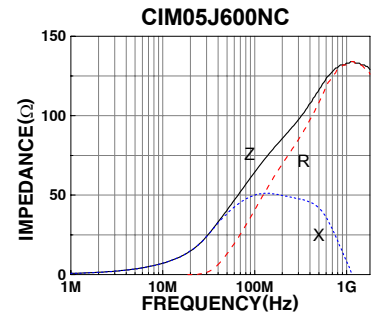
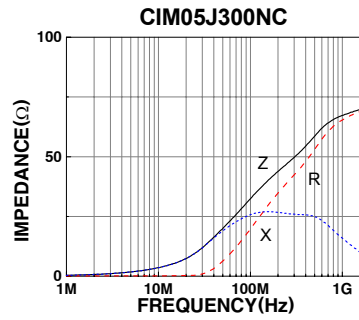
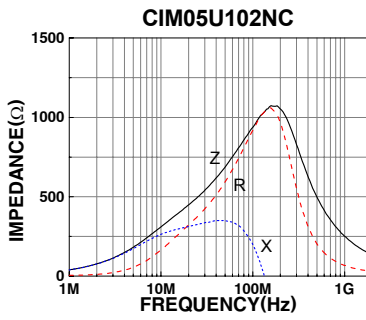
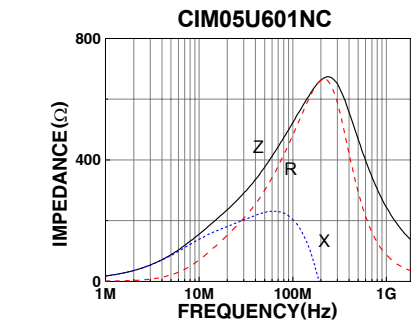
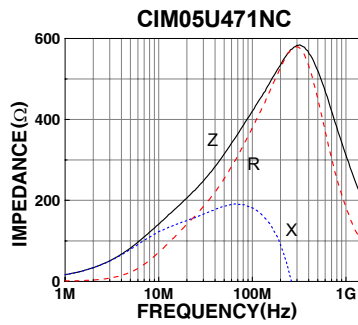
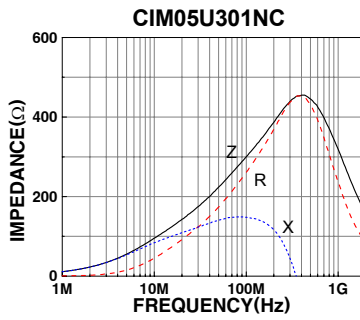
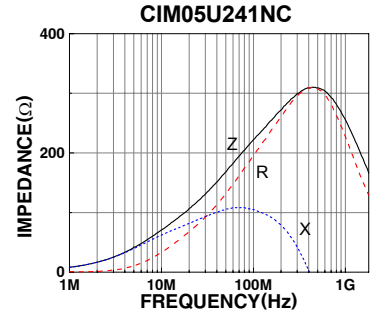
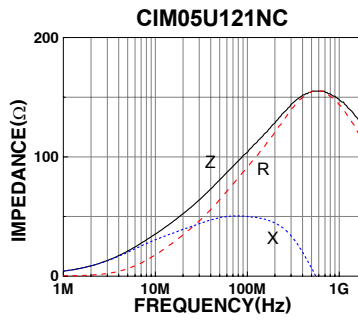
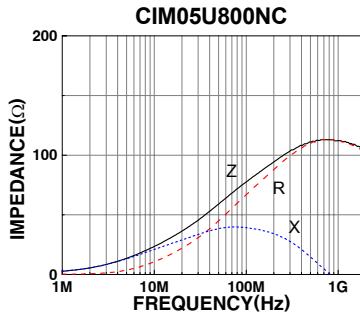
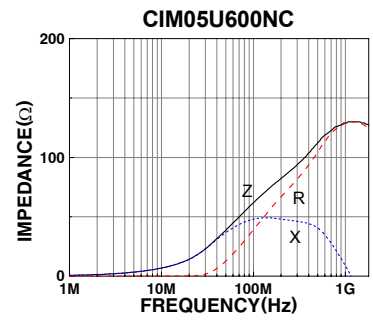
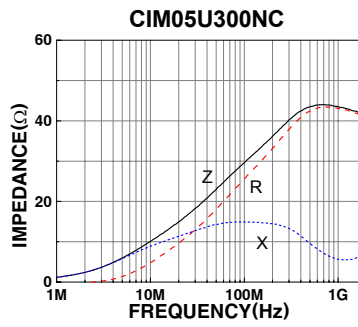
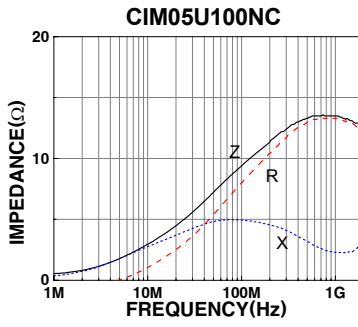

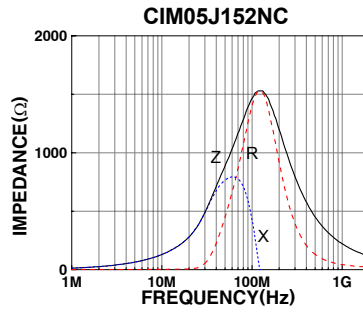
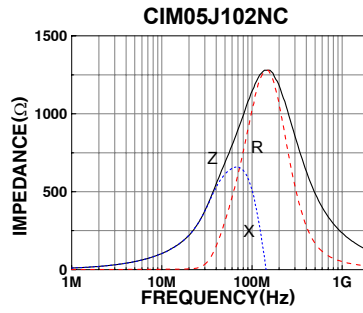
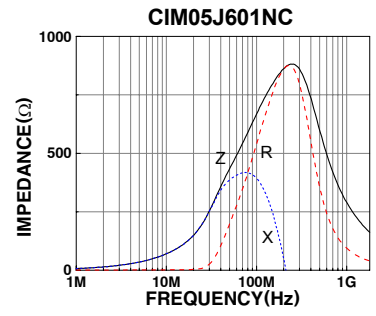
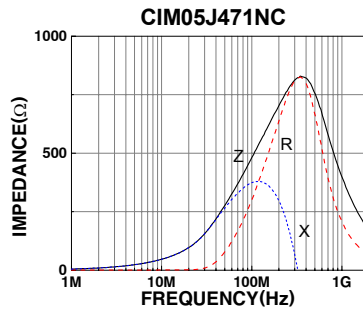
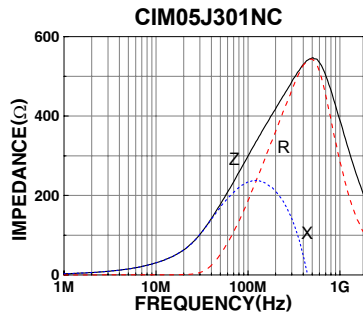

**● CIB / CIM 1608(0603) Type**

Part No.	Thickness [mm]	Impedance [Ω]± 25% @100MHz	DC Resistance [Ω] MAX	Rated Current [mA] MAX
CIB 10P 260	0.8 ± 0.15	26	0.08	1000
CIB 10P 330	0.8 ± 0.15	33	0.08	1000
CIM 10U 121	0.8 ± 0.15	120	0.25	500
CIM 10U 241	0.8 ± 0.15	240	0.3	400
CIM 10U 471	0.8 ± 0.15	470	0.35	300
CIM 10U 601	0.8 ± 0.15	600	0.45	300
CIM 10U 102	0.8 ± 0.15	1000	0.7	250
CIM 10U 202	0.8 ± 0.15	2000 (at 70MHz)	1.2	200
CIM 10J 400	0.8 ± 0.15	40	0.12	600
CIM 10J 600	0.8 ± 0.15	60	0.12	600
CIM 10J 800	0.8 ± 0.15	80	0.2	550
CIM 10J 121	0.8 ± 0.15	120	0.2	500
CIM 10J 151	0.8 ± 0.15	150	0.2	400
CIM 10J 241	0.8 ± 0.15	240	0.3	400
CIM 10J 471	0.8 ± 0.15	470	0.35	300
CIM 10J 601	0.8 ± 0.15	600	0.45	300
CIM 10J 102	0.8 ± 0.15	1000	0.7	250
CIM 10J 152	0.8 ± 0.15	1500	1	250
CIM 10K 152	0.8 ± 0.15	1500	0.8	250
CIM 10K 202	0.8 ± 0.15	2000	1.0	200
CIM 10K 252	0.8 ± 0.15	2500	1.2	200
CIM 10N 700	0.8 ± 0.15	70	0.3	450
CIM 10N 121	0.8 ± 0.15	120	0.4	450
CIM 10N 241	0.8 ± 0.15	240	0.8	350



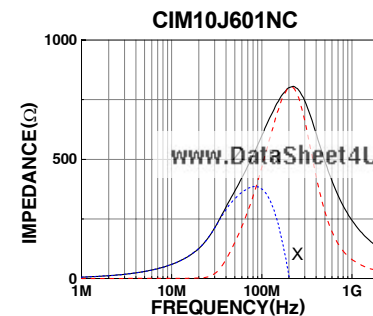
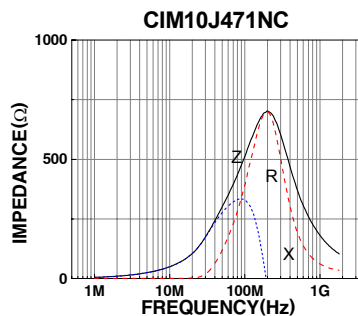
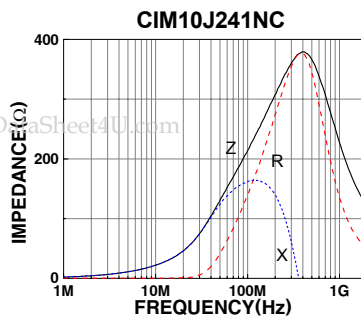
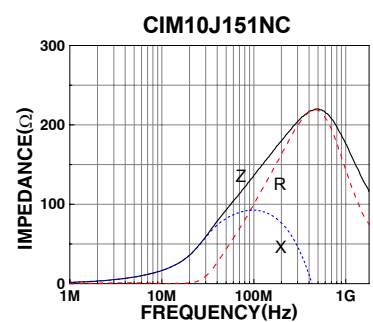
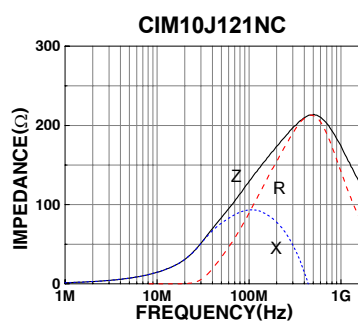
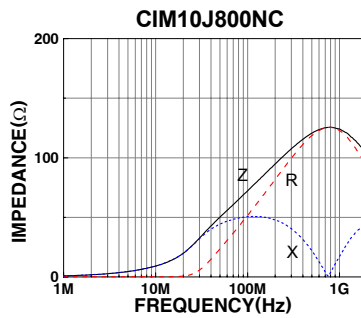
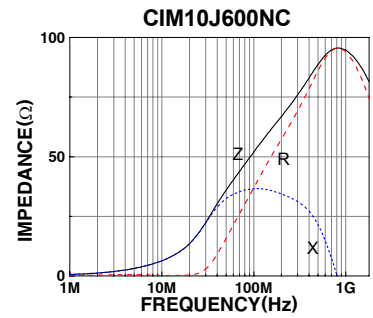
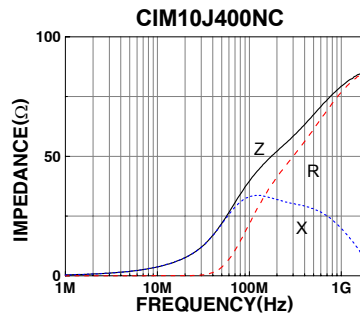
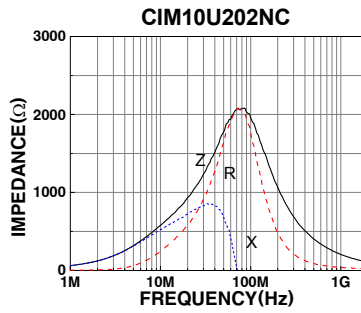
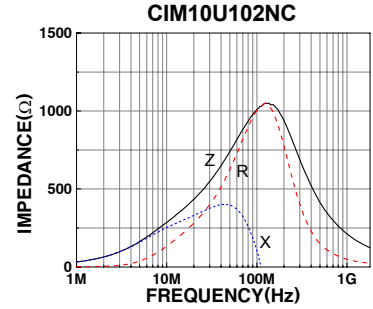
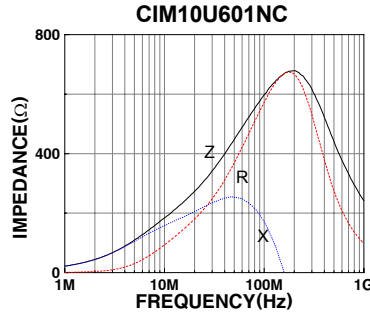
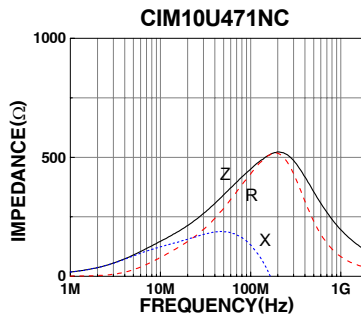
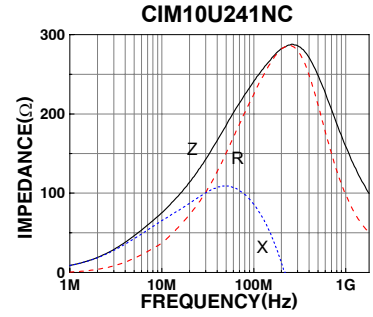
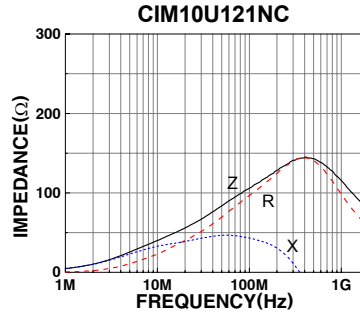
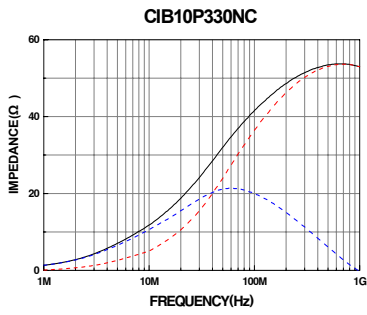

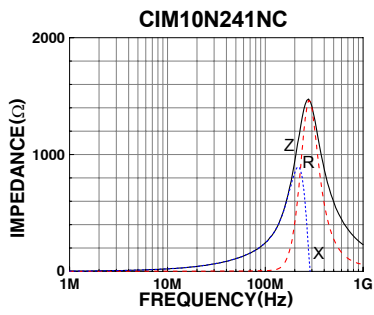
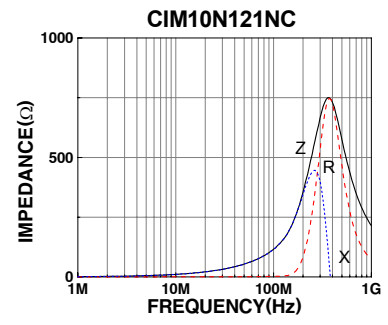
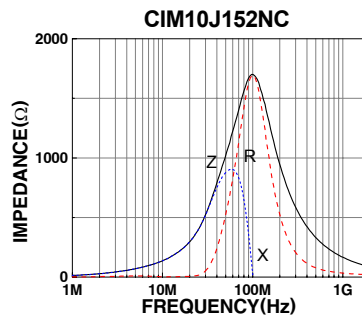
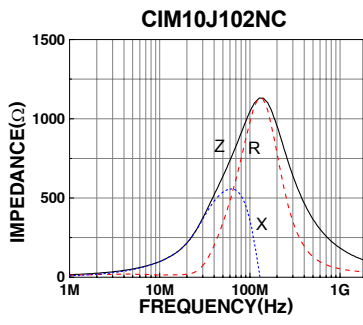

**● CIB / CIM 2012(0805) Type**

Part No.	Thickness [mm]	Impedance [Ω]± 25% @100MHz	DC Resistance [Ω] MAX	Rated Current [mA] MAX
CIB 21P 110	0.9 ± 0.2	11	0.05	2000
CIB 21P 260	0.9 ± 0.2	26	0.05	2000
CIB 21P 330	0.9 ± 0.2	33	0.05	1500
CIB 21P 470	0.9 ± 0.2	47	0.05	1500
CIM 21U 800	0.9 ± 0.2	80	0.1	900
CIM 21U 101	0.9 ± 0.2	100	0.1	500
CIM 21U 121	0.9 ± 0.2	120	0.15	500
CIM 21U 151	0.9 ± 0.2	150	0.15	400
CIM 21U 241	0.9 ± 0.2	240	0.15	400
CIM 21U 301	0.9 ± 0.2	300	0.15	400
CIM 21U 471	0.9 ± 0.2	470	0.3	400
CIM 21U 601	0.9 ± 0.2	600	0.3	400
CIM 21U 102	0.9 ± 0.2	1000(at 70MHz)	0.45	400
CIM 21U 202	0.9 ± 0.2	2000(at 70MHz)	0.7	300
CIB 21J 260	0.9 ± 0.2	26	0.05	2000
CIB 21J 400	0.9 ± 0.2	40	0.05	2000
CIM 21J 600	0.9 ± 0.2	60	0.1	900
CIM 21J 800	0.9 ± 0.2	80	0.1	900
CIM 21J 121	0.9 ± 0.2	120	0.15	600
CIM 21J 151	0.9 ± 0.2	150	0.15	500
CIM 21J 241	0.9 ± 0.2	240	0.2	400
CIM 21J 301	0.9 ± 0.2	300	0.25	400
CIM 21J 471	0.9 ± 0.2	470	0.25	400
CIM 21J 601	0.9 ± 0.2	600	0.25	400
CIM 21J 102	0.9 ± 0.2	1000	0.40	400
CIM 21J 152	0.9 ± 0.2	1500(at 70MHz)	0.55	300
CIM 21J 202	0.9 ± 0.2	2000(at 70MHz)	0.7	300
CIM 21K 152	0.9 ± 0.2	1500	0.55	300
CIM 21K 252	0.9 ± 0.2	2500	0.8	250
CIM 21N 700	0.9 ± 0.2	70	0.2	www.DataSheet4U.com
CIM 21N 121	0.9 ± 0.2	120	0.3	500
CIM 21N 241	0.9 ± 0.2	240	0.4	400

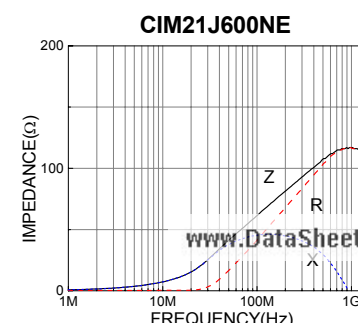
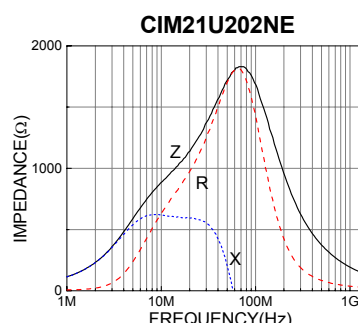
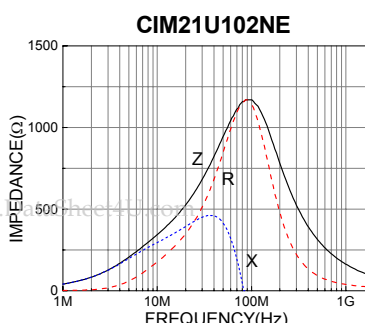
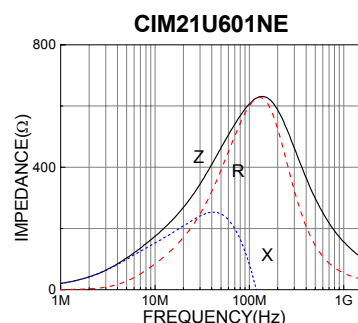
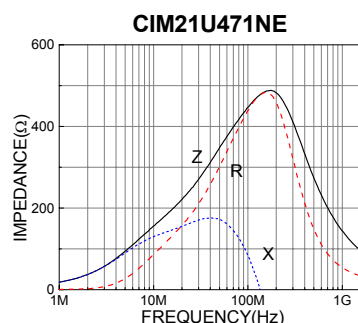
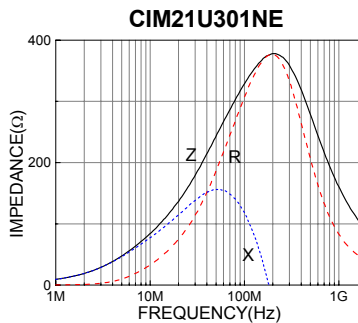
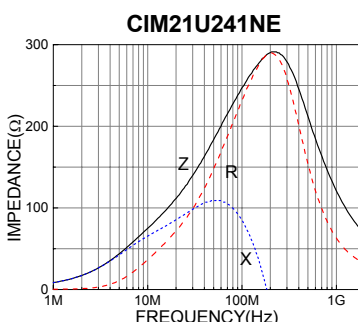
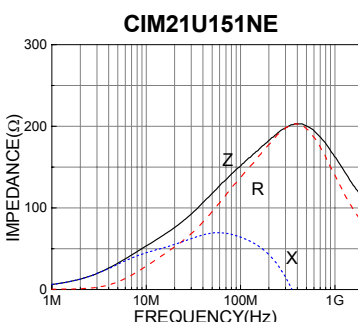
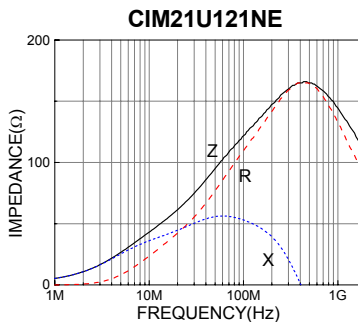
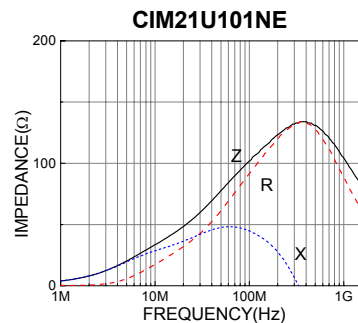
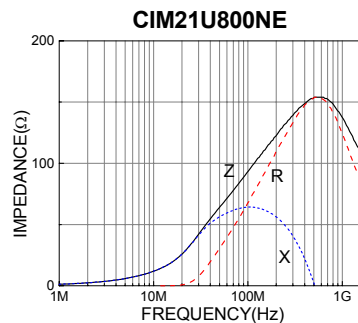
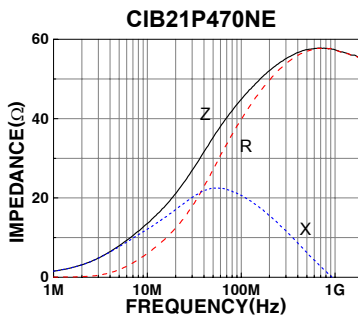
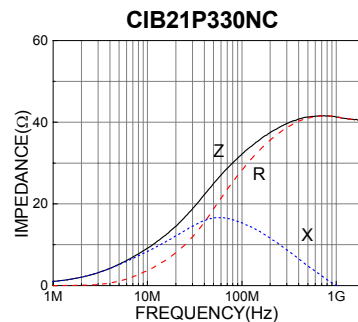
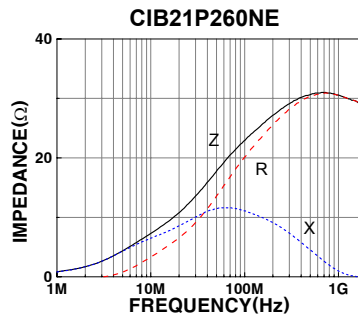
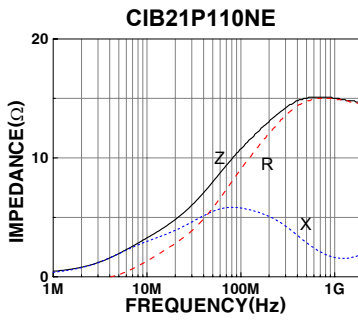

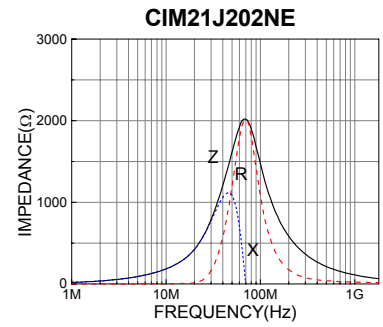
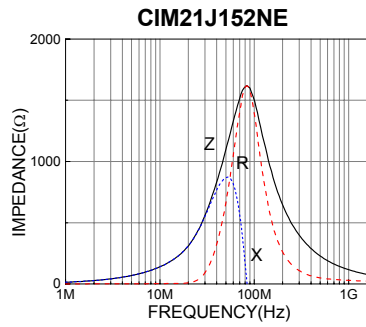
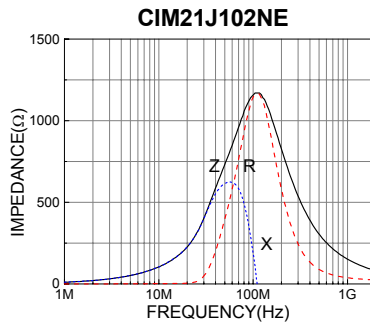
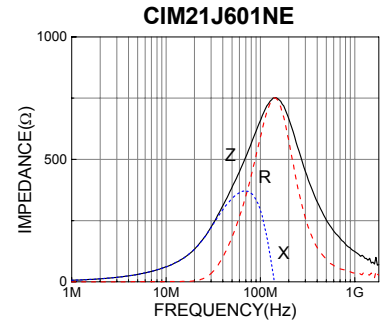
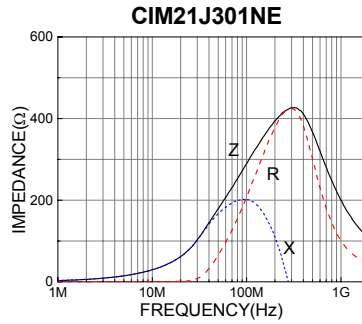
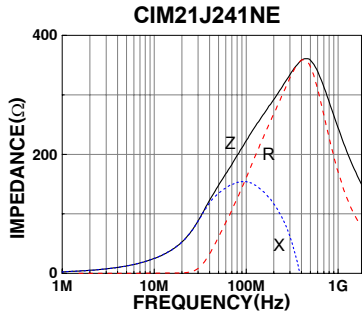
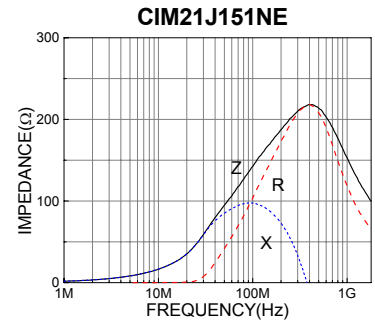
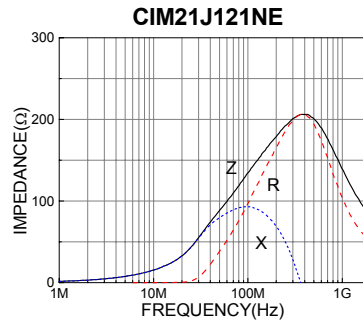
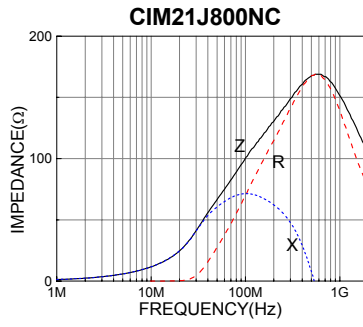

## ● CIB / CIM 3216(1206) Type

Part No.	Thickness [mm]	Impedance [Ω]± 25% @100MHz	DC Resistance [Ω] MAX	Rated Current [mA] MAX
CIB 31P 260	1.1 ± 0.2	26	0.05	2000
CIB 31P 310	1.1 ± 0.2	31	0.05	2000
CIB 31P 500	1.1 ± 0.2	50	0.05	2000
CIB 31P 700	1.1 ± 0.2	70	0.1	1500
CIM 31U 601	1.1 ± 0.2	600	0.3	400
CIM 31J 151	1.1 ± 0.2	150	0.2	500
CIM 31J 221	1.1 ± 0.2	220	0.2	400
CIM 31J 301	1.1 ± 0.2	300	0.25	400
CIM 31J 601	1.1 ± 0.2	600	0.3	400
CIM 31J 801	1.1 ± 0.2	800	0.4	400
CIM 31J 102	1.1 ± 0.2	1000	0.45	400
CIM 31J 152	1.1 ± 0.2	1500(at 70MHz)	0.55	300

## ● Other Types

Part No.	Thickness [mm]	Impedance [Ω]± 25% @100MHz	DC Resistance [Ω] MAX	Rated Current [mA] MAX
CIB 32P 310	1.3 ± 0.2	31	0.02	3000
CIB 32P 600	1.3 ± 0.2	60	0.02	1500
CIB 41P 800	1.6 ± 0.2	80	0.03	1000
CIB 41P 151	1.6 ± 0.2	150	0.05	1000
CIB 43P 131	1.5 ± 0.2	130	0.04	600
CIB 43P 151	1.5 ± 0.2	150	0.04	600

We can provide custom product to meet customers need in addition to these products.

Test equipment : HP4291A + HP16193A

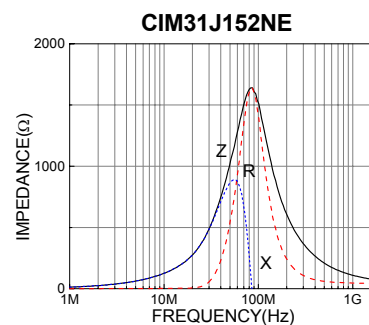
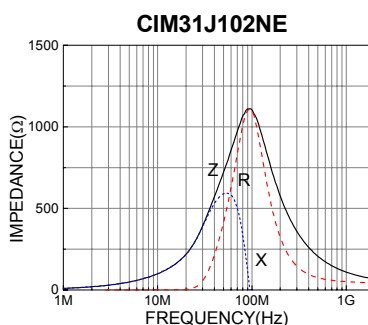
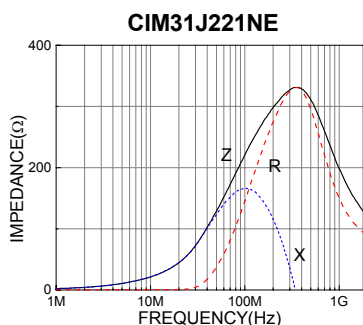
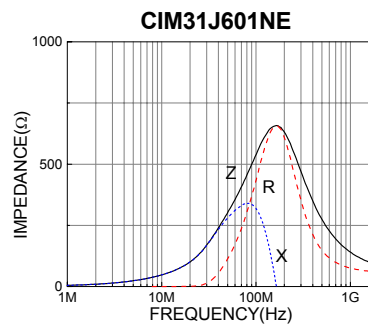
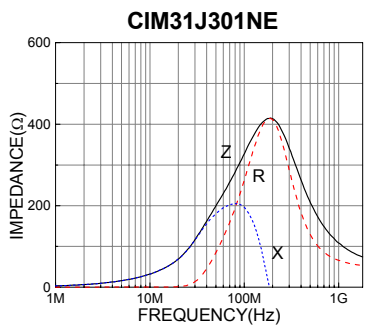
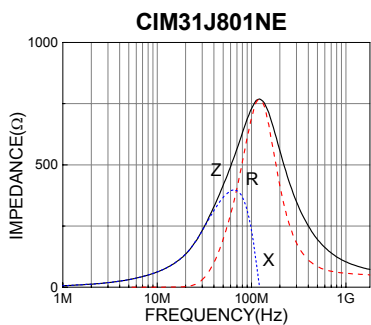
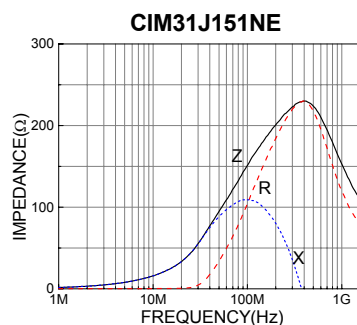
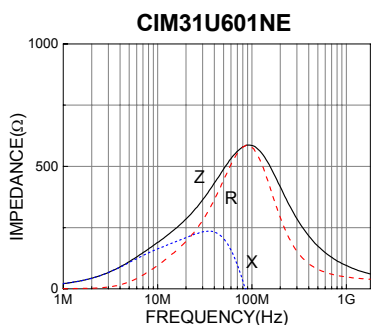
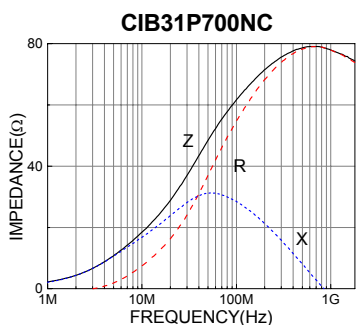
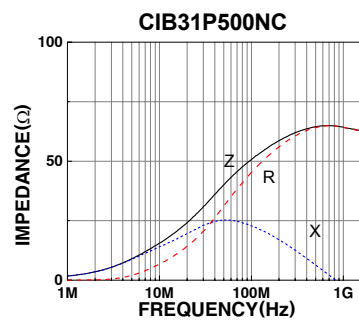
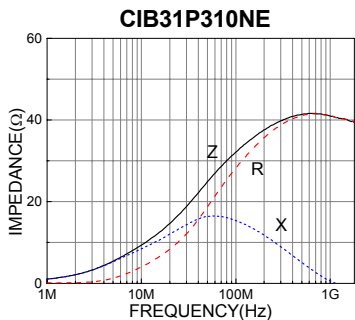
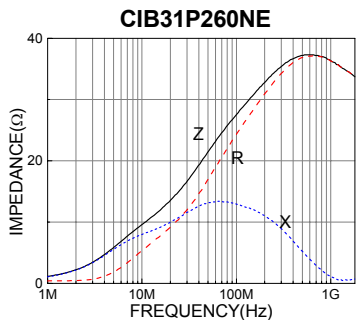

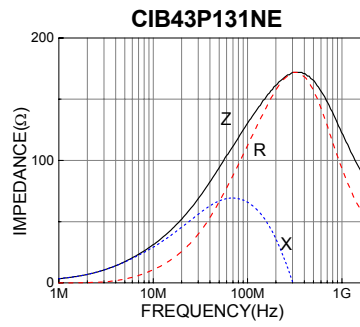
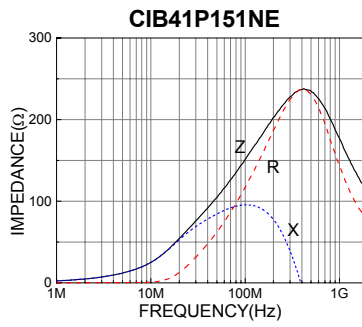
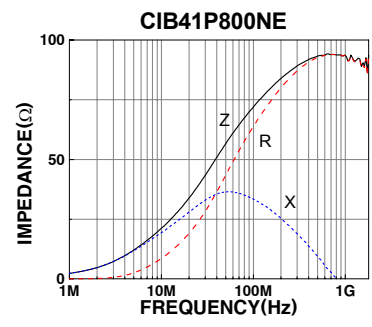
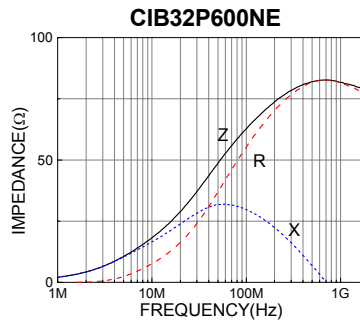
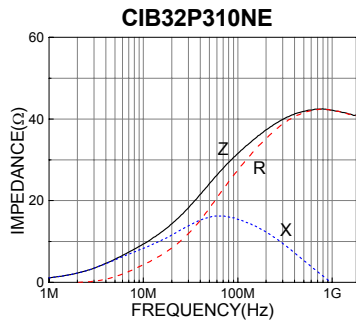



## RELIABILITY TEST CONDITION

ITEM	PERFORMANCE			TEST CONDITION
	CIB/CIM	CIC/CIS	CIA	
1. OPERATING TEMPERATURE RANGE	-55 to +125℃		-25 to +85℃	-
2. STORAGE TEMPERATURE RANGE	-55 to +125℃		-40 to +85℃	-
3. IMPEDANCE	SEE THE SECTION OF ELECTRICAL PROPERTIES.			<ul style="list-style-type: none"> <li>- MEASURING FREQUENCY : 100 ± 1MHz</li> <li>- MEASURING EQUIPMENT, TEST FIXTURE : HP4291A/B + HP16193A (CIB/CIM/CIC/CIS SERIES) HP4291A/B + HP16192A (CIA SERIES)</li> <li>- SOURCE OSC LEVEL : 30 mV</li> </ul>
4. DC RESISTANCE	SEE THE SECTION OF ELECTRICAL PROPERTIES.			- MEASURING EQUIPMENT : HP4338A/B
5. HIGH TEMPERATURE TEST	NO APPARENT DAMAGE. IMPEDANCE CHANGE TO BE WITHIN ±30% TO THE INITIAL.		-	SOLDER THE SAMPLE ON PCB. EXPOSURE AT 125±3℃ FOR 500 HOURS. 1-2 HOURS EXPOSURE AT ROOM TEMPERATURE AND HUMIDITY PRIOR TO MEASUREMENT.
6. SOLDER HEAT RESISTANCE	NO MECHANICAL DAMAGE. REMAINING TERMINAL ELECTRODE : 70% MIN. IMPEDANCE CHANGE TO BE WITHIN ±30% TO THE INITIAL.	MORE THAN 75% OF THE TERMINAL SURFACE IS TO BE COVERED WITH SOLDER. NO MECHANICAL DAMAGE. IMPEDANCE VARIATION : WITHIN ±20%		AFTER BEING DIPPED IN FLUX FOR 4±1 SECONDS, AND PREHEATED AT 150~180℃ FOR 2~3 MIN , THE SPECIMEN SHALL BE IMMERSSED IN 60/40 TIN-LEAD ALLOY SOLDER AT 260±5℃ FOR 10 ± 0.5 SECONDS.
7. SOLDERABILITY	MORE THAN 95% OF TERMINAL ELECTRODE SHOULD BE SOLDERED NEWLY.	MORE THAN 90% OF TERMINAL ELECTRODE SHOULD BE SOLDERED NEWLY.		AFTER BEING DIPPED IN FLUX FOR 4±1 SECONDS, AND PREHEATED AT 150~180℃ FOR 2~3 MIN , THE SPECIMEN SHALL BE IMMERSSED IN SOLDER AT 230 ±5℃ (FOR CIA SERIES : 245 ±5℃) FOR 4±1 SECONDS.
8. THERMAL SHOCK	IMPEDANCE VARIATION : WITHIN 30%. NO MECHANICAL DAMAGE.	IMPEDANCE VARIATION : WITHIN 20%. NO MECHANICAL DAMAGE.		<ul style="list-style-type: none"> <li>- CIB/CIM SERIES <a href="http://www.DataSheet4U.com">www.DataSheet4U.com</a> -55 ↔ +125℃, 30 MINUTES EACH. 5 CYCLES.</li> <li>- CIC/CIS SERIES -55 ↔ +125℃, 30 MINUTES EACH. 100 CYCLES.</li> <li>- CIA SERIES -40 ↔ +85℃, 30 MINUTES EACH. 5 CYCLES.</li> </ul>

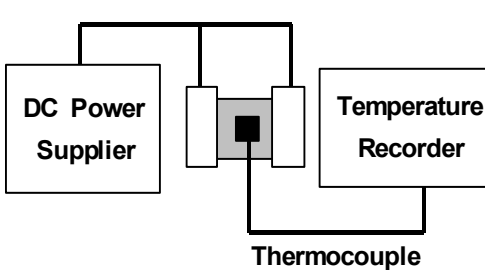
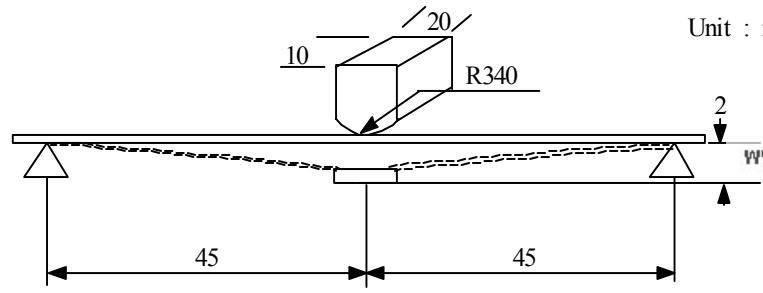
ITEM	PERFORMANCE			TEST CONDITION
	CIB/CIM	CIC/CIS	CIA	
9. MOISTURE LOADING TEST	IMPEDANCE VARIATION : WITHIN 30%. NO MECHANICAL DAMAGE.	IMPEDANCE VARIATION : WITHIN 20%. NO MECHANICAL DAMAGE.	IMPEDANCE VARIATION : WITHIN 20%. NO MECHANICAL DAMAGE.	- TEMPERATURE : $40 \pm 2^\circ\text{C}$ - HUMIDITY : 90 ~ 95 %RH - DURATION : $500 \pm 5$ HRS. $1000 \pm 12$ HRS. (CIA SERIES) - CURRENT : RATED CURRENT
10. HIGH TEMPERATURE LOADING	IMPEDANCE VARIATION : WITHIN 30%. NO MECHANICAL DAMAGE.	IMPEDANCE VARIATION : WITHIN 20%. NO MECHANICAL DAMAGE.	IMPEDANCE VARIATION : WITHIN 20%. NO MECHANICAL DAMAGE.	- TEMPERATURE : $125 \pm 3^\circ\text{C}$ $85 \pm 3^\circ\text{C}$ (CIA SERIES) - DURATION : $500 \pm 5$ HRS. $1000 \pm 12$ HRS. (CIA SERIES) - CURRENT : RATED CURRENT
11. LOW TEMPERATURE RESISTANCE	IMPEDANCE VARIATION : WITHIN 30%. NO MECHANICAL DAMAGE.	IMPEDANCE VARIATION : WITHIN 20%. NO MECHANICAL DAMAGE.	IMPEDANCE VARIATION : WITHIN 20%. NO MECHANICAL DAMAGE.	- TEMPERATURE : $-55 \pm 2^\circ\text{C}$ $-40 \pm 2^\circ\text{C}$ (CIA SERIES) - DURATION : $500 \pm 5$ HRS. $1000 \pm 12$ HRS. (CIA SERIES)
12. RATED CURRENT	-	TEMPERATURE INCREASE - CIC : $40^\circ\text{C}$ - CIS : $60^\circ\text{C}$	-	- APPLIED CURRENT : RATED CURRENT - TIME : 5 MIN. - ROOM TEMPERATURE : $25 \pm 5^\circ\text{C}$ 
13. BENDING TEST	NO APPARENT DAMAGE.			SOLDER THE SAMPLE ON PCB, BEND TO 2mm.
	 <p>Unit : mm</p>			

CIB/CIM Series

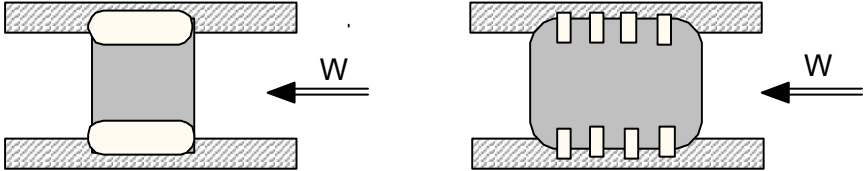
ITEM	PERFORMANCE			TEST CONDITION			
	CIB/CIM	CIC/CIS	CIA				
14. VIBRATION TEST	IMPEDANCE VARIATION : WITHIN 30%. NO MECHANICAL DAMAGE.	IMPEDANCE VARIATION : WITHIN 20%. NO MECHANICAL DAMAGE.		APPLY VIBRATIONS IN EACH OF THE X, Y AND Z DIRECTIONS. - FREQUENCY : 10 ~ 55 ~ 10Hz - TOTAL AMPLITUDE : 1.52mm - TIME : 2 HRS. EACH (TOTAL 6 HRS.)			
15. DROP TEST	IMPEDANCE VARIATION : WITHIN 30%. NO MECHANICAL DAMAGE.	IMPEDANCE VARIATION : WITHIN 20%. NO MECHANICAL DAMAGE.		DROP THE SAMPLE FROM A HEIGHT OF 1m TO CONCRETE GROUND 10 TIMES.			
16. TERMINAL TEST	NO INDICATION OF PEELING SHALL OCCUR ON THE TERMINAL ELECTRODE.			<b>SIZE</b>	<b>W(Kgf)</b>	<b>SIZE</b>	<b>W(Kgf)</b>
				05	0.5	31 (CIA)	0.5
				10	0.5	32	1.0
				21	0.5	41	1.0
				31	1.0	43	1.0
				- APPLYING TIME : 10±1 SEC.			
							

CIB/CIM Series

## PACKAGING

### ● CARDBOARD PAPER TAPE

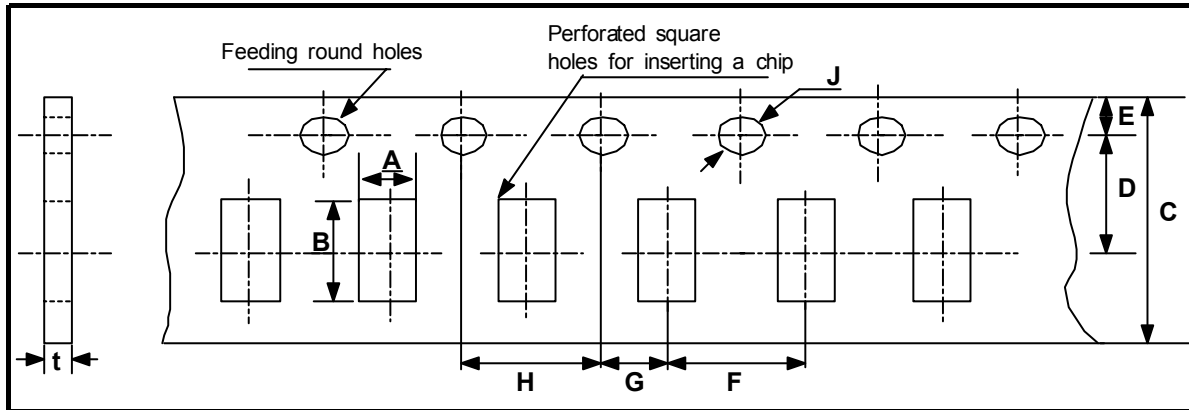

unit : mm

TYPE	A	B	C	D	E	F	G	H	J	t max.
05	0.65 ±0.1	1.15 ±0.1	8.0 ±0.2	3.5 ±0.05	1.75 ±0.1	2.0 ±0.05	2.0 ±0.1	4.0 ±0.1	Φ1.5 +0.1/-0	0.8
10	1.0 ±0.2	1.80 ±0.2				4.0 ±0.1				

### ● EMBOSSED PLASTIC TAPE

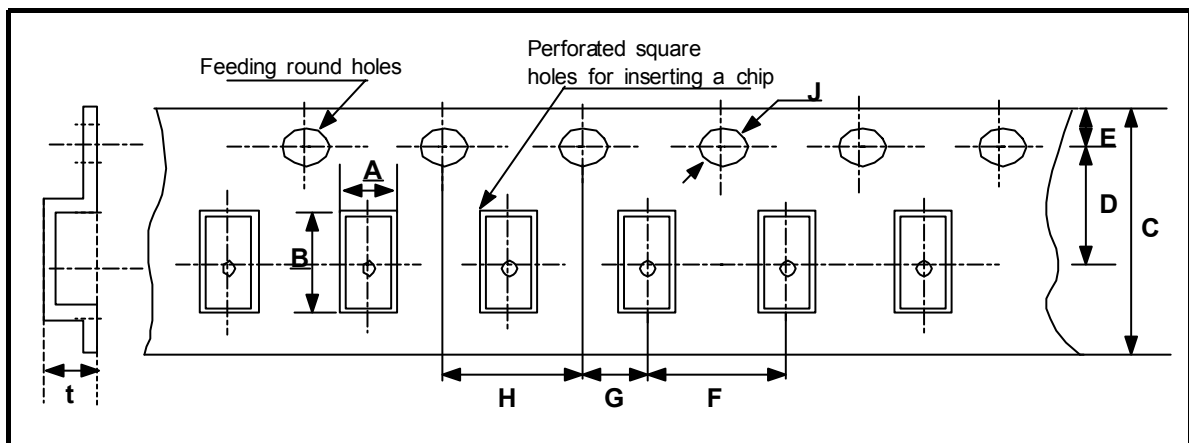

unit : mm

TYPE	A	B	C	D	E	F	G	H	J	t max.
21	1.50 ±0.2	2.3 ±0.2	8.0 ±0.3	3.5 ±0.05	1.75 ±0.1	4.0 ±0.1	2.0 ±0.1	4.0 ±0.1	Φ1.5 +0.1/-0	1.5
31	1.90 ±0.2	3.6 ±0.2								8.0 ±0.1
32	2.9 ±0.2	3.6 ±0.2	12.0 ±0.3	5.5 ±0.05	8.0 ±0.1	8.0 ±0.1	2.0 ±0.1	4.0 ±0.1	Φ1.5 +0.1/-0	1.55
41	1.90 ±0.2	4.9 ±0.2								1.8
43	3.5 ±0.2	±0.2	±0.3	±0.05	±0.1	±0.1	±0.1	±0.1	±0.1	1.8

## ● TAPING SIZE

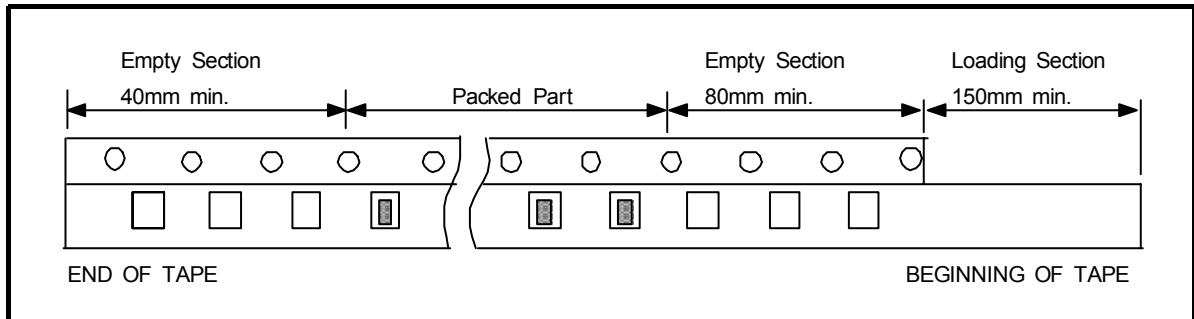

unit : pcs

Symbol	05	10	21	31	32	41	43
7" Reel	10,000	4,000	4,000	3,000	2,500	2,000	1,000

## ● REEL DIMENSION

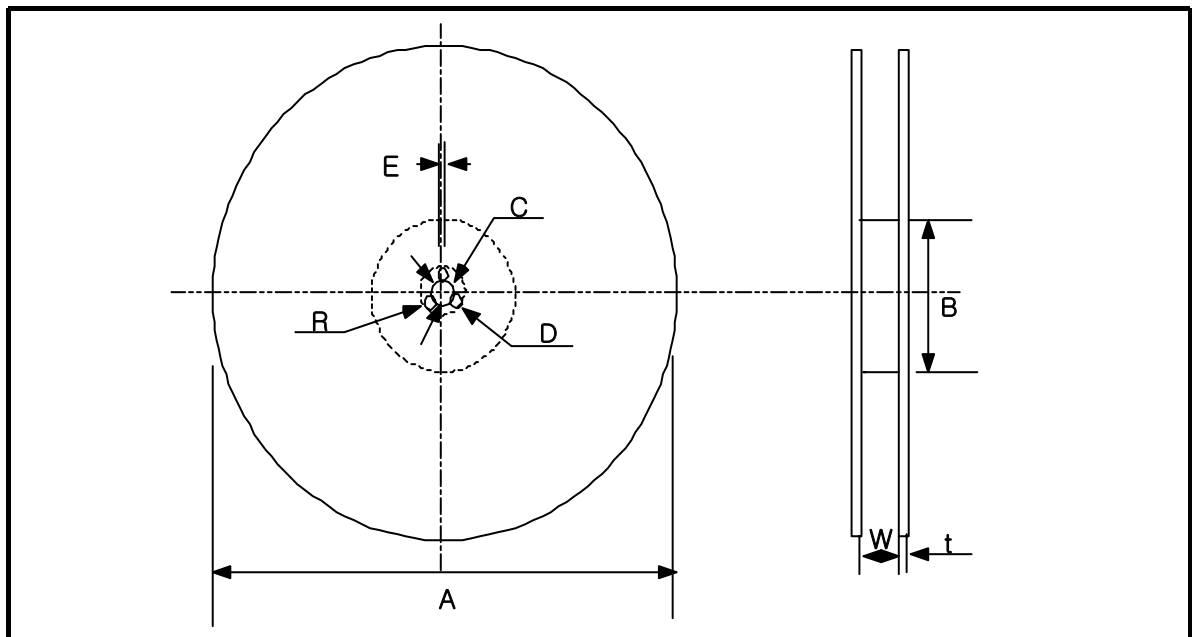

unit : mm

Tape Width	A	B	C	D	E	W	t	R
8 mm	$\phi 178 \pm 2.0$	$\phi 50 \pm 1.0$	$\phi 13 \pm 0.5$	$21 \pm 0.8$	$2.0 \pm 0.5$	$10 \pm 1.5$	$1.2 \pm 0.5$	1.0
12 mm						$14 \pm 1.5$	$2.0 \pm 0.5$	