

2SC1946A

NPN EPITAXIAL PLANAR TYPE

DESCRIPTION

2SC1946A is a silicon NPN epitaxial planar type transistor designed for RF power amplifiers on VHF band mobile radio applications.

FEATURES

- High power gain: $G_{pe} \geq 10\text{dB}$
@ $V_{CC} = 13.5\text{V}$, $P_O = 30\text{W}$, $f = 175\text{MHz}$
- Emitter ballasted construction and gold metallization for high reliability and good performances.
- Low thermal resistance ceramic package with flange.
- Ability of withstanding more than 20:1 load VSWR when operated at $V_{CC} = 15.2\text{V}$, $P_O = 30\text{W}$, $f = 175\text{MHz}$.
- Equivalent input/output impedance at rated operating conditions: $Z_{in} = 0.65 + j1.4\Omega$
 $Z_{out} = 1.9 + j0.75\Omega$

APPLICATION

25 watts output power amplifiers in VHF band mobile radio applications.

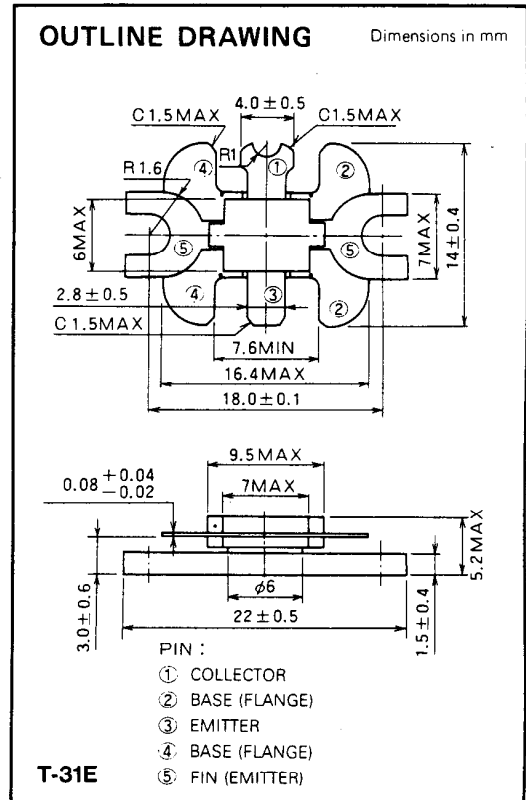

ABSOLUTE MAXIMUM RATINGS ($T_C = 25^\circ\text{C}$ unless otherwise specified)

Symbol	Parameter	Conditions	Ratings	Unit
V_{CBO}	Collector to base voltage		35	V
V_{EBO}	Emitter to base voltage		4	V
V_{CEO}	Collector to emitter voltage	$R_{BE} = \infty$	17	V
I_C	Collector current		7	A
P_C	Collector dissipation	$T_a = 25^\circ\text{C}$	3	W
		$T_C = 25^\circ\text{C}$	50	W
T_j	Junction temperature		175	$^\circ\text{C}$
T_{stg}	Storage temperature		-55 to 175	$^\circ\text{C}$
R_{th-a}	Thermal resistance	Junction to ambient	50	$^\circ\text{C}/\text{W}$
R_{th-c}		Junction to case	3	$^\circ\text{C}/\text{W}$

Note. Above parameters are guaranteed independently.

ELECTRICAL CHARACTERISTICS ($T_C = 25^\circ\text{C}$ unless otherwise specified)

Symbol	Parameter	Test conditions	Limits			Unit
			Min	Typ	Max	
$V_{(BR)EBO}$	Emitter to base breakdown voltage	$I_E = 10\text{mA}$, $I_C = 0$	4			V
$V_{(BR)CBO}$	Collector to base breakdown voltage	$I_C = 10\text{mA}$, $I_E = 0$	35			V
$V_{(BR)CEO}$	Collector to emitter breakdown voltage	$I_C = 0.1\text{A}$, $R_{BE} = \infty$	17			V
I_{CBO}	Collector cutoff current	$V_{CB} = 25\text{V}$, $I_E = 0$			2	mA
I_{EBO}	Emitter cutoff current	$V_{EB} = 3\text{V}$, $I_C = 0$			1	mA
h_{FE}	DC forward current gain *	$V_{CE} = 10\text{V}$, $I_C = 0.2\text{A}$	10	50	180	—
P_O	Output power	$V_{CC} = 13.5\text{V}$, $P_{in} = 3\text{W}$, $f = 175\text{MHz}$	30	35		W
η_C	Collector efficiency		60	70		%

Note. * Pulse test, $P_w = 150\mu\text{s}$, duty = 5%.

Above parameters, ratings, limits and conditions are subject to change.

TEST CIRCUIT

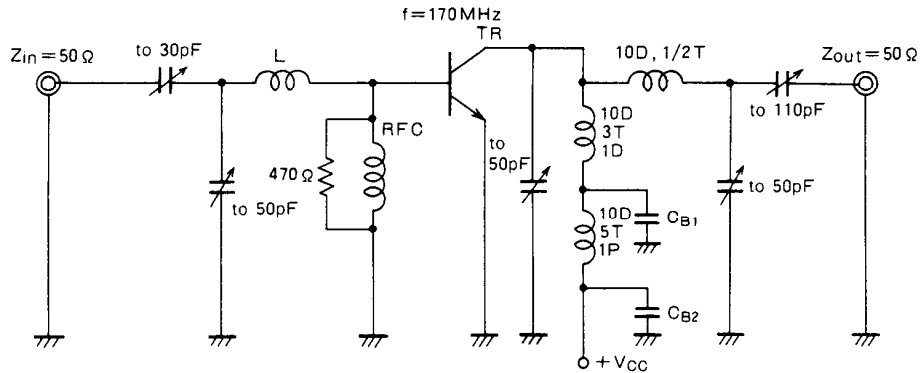

L: Length 10mm
 RFC: 0.4mm enameled wire 12T with Ferrite Bead
 C_{B1}: 220pF, 2200pF in parallel
 C_{B2}: 220pF, 2200pF, 10μF in parallel

Notes: All coils are made from 1.5mmφ silver plated copper wire
 Coil dimensions in milli-meter
 D: Inner diameter of coil
 T: Turn number of coil
 P: Pitch of coil

TYPICAL PERFORMANCE DATA

COLLECTOR DISSIPATION VS. AMBIENT TEMPERATURE

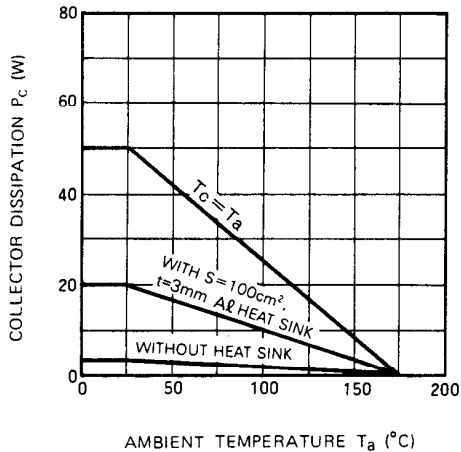

COLLECTOR CURRENT VS. COLLECTOR TO EMITTER VOLTAGE

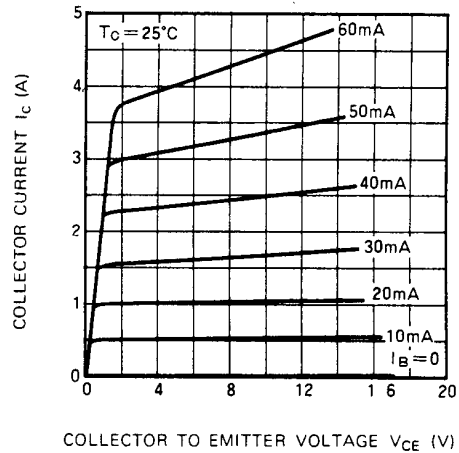

COLLECTOR TO EMITTER BREAKDOWN VOLTAGE VS. BASE TO EMITTER RESISTANCE

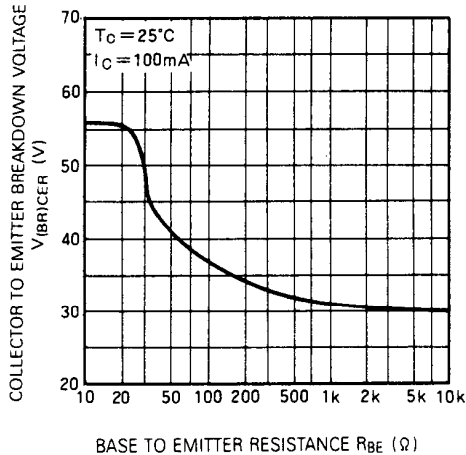

DC CURRENT GAIN VS. COLLECTOR CURRENT

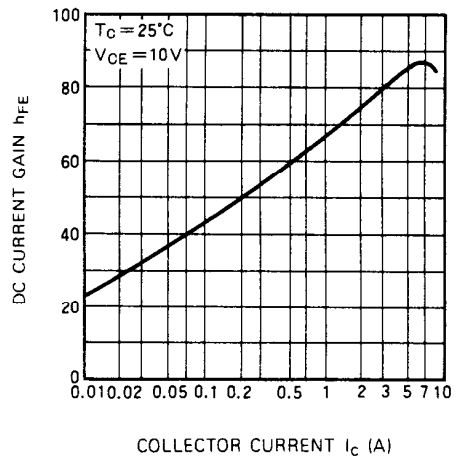

MITSUBISHI RF POWER TRANSISTOR
2SC1946A

NPN EPITAXIAL PLANAR TYPE

**COLLECTOR OUTPUT CAPACITANCE VS.
 COLLECTOR TO BASE VOLTAGE**

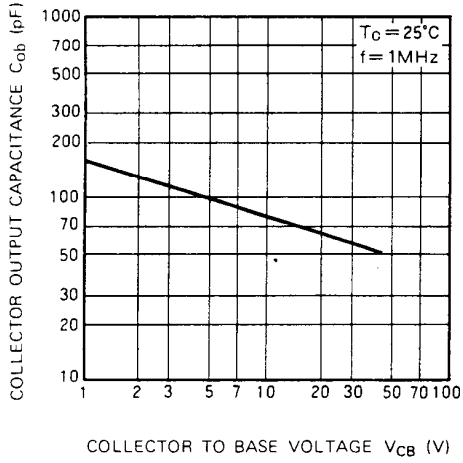

**OUTPUT POWER, COLLECTOR EFFICIENCY
 VS. INPUT POWER**

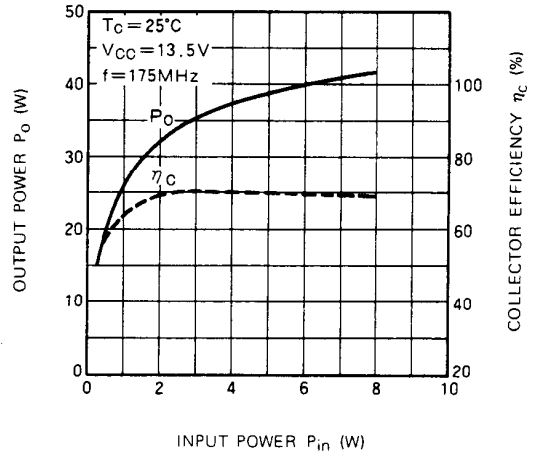

**OUTPUT POWER VS. COLLECTOR
 SUPPLY VOLTAGE**

