



**ST video kit for CRT monitor:
Optimization of the video performances with input networks**

written by ADRIEN BONNAT

The purpose of the present Application Note is to help the designers of the Video board for Monitor to get optimum video performances with the ST Video device kit (PreAmplifier + Amplifiers) in stand alone by using a proper Amplifier Input network.

Although this report is referring to the TDA9210 (Preamplifiers) + STV9556 (7.5ns Amplifier), it is valid for the whole range of the ST stand alone Video devices.

(PreAmplifiers TDA9210/9210S./STV9211 and Amplifiers: STV9556/9555/9553) .

Note: The components values hereafter indicated per network are also the ones used on our reference video board to ensure the best matching between the TDA9210 and the STV9556.

When using different ST Devices such as TDA92xx/ STV9211+ STV95xx, the values of the network components might be slightly different.

Note also that these values depend on the board layout. It is possible that the parasitical components differ from one layout to another. This also affects the network components.

We do not guarantee that the networks presented in this document are usable in a non-ST video system.

This network list, which is not exhaustive, shows the common networks used.

Scope

Scope: CRT Monitor - Video devices in Stand alone

Purpose: Adjustment of the Networks between the preamplifier and the amplifier to get the optimum video performances.

1 Measurement conditions

The nominal measurement conditions included in this document are the following:

- Video Board: ST EVALCRT51 (ref AB25BX) with TDA9210 + STV9556
- Pattern generator: Chroma 2251 (250MHz)
- Timing: #62 (ADI1280-60) 1280 x 1024, H= 64KHz, V= 60Hz, Pix = 110MHz
- Pattern: #42 (5 - Mosaic) 5 white square boxes on black background
- Monitor: VITA 17" 70KHz / (ST7 + TDA9111 + TDA8172)
- Oscilloscope: Tektronix TDS754A, Digital, 500MHz
- Probes:
 - Low voltage: Tektronix P6205, active, 10x, 750MHz, <2pF
 - High voltage: Tektronix P5100, passive, 100x, 250MHz, <2.7pF

The following waveforms (Figures 1 and 2) show the video signal on the Red channel, both on the input of the amplifier and on the cathode and with only a 51 Ω resistor between the preamplifier and the amplifier:

Figure 1: Red signals without network

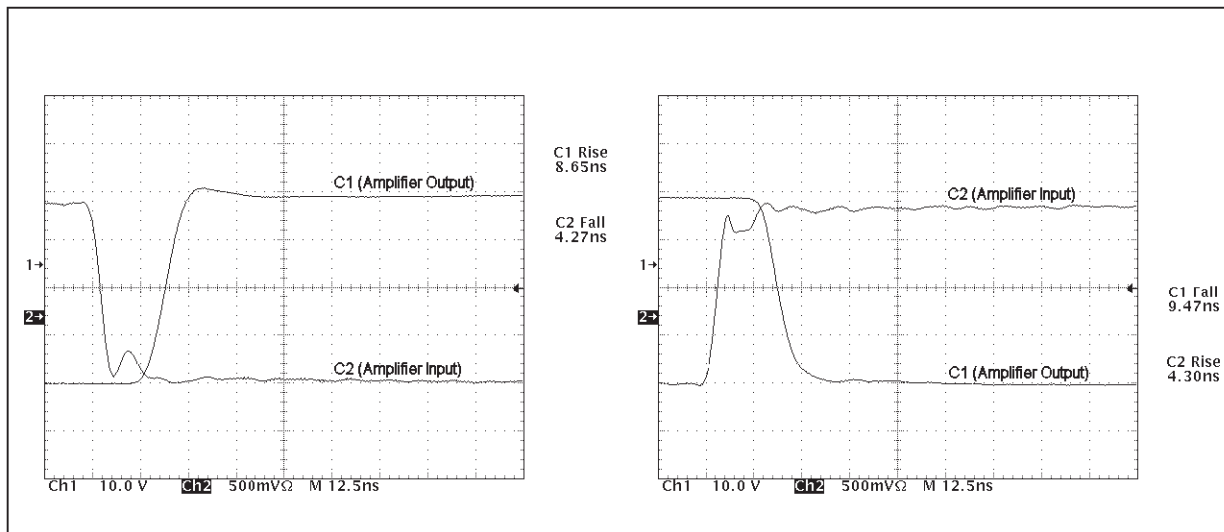

2 The 3 networks and their effects

2.1 Network 1

2.1.1 Description

Figure 2: Network 1

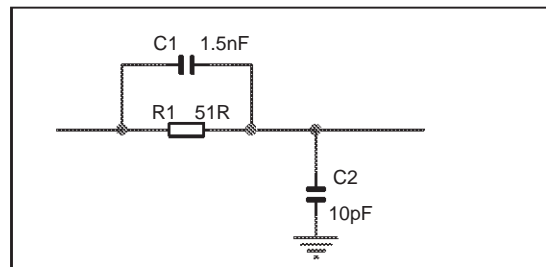

- C1 and R1 are adjusted to correct an eventual smear effect and to increase the bandwidth.
- The C2 capacitor adds a high frequency peaking. It is mandatory that this capacitor matches R1 to avoid the preamplifier overload and the bandwidth downgrading.

Advantages: Network 1 increases the bandwidth.

Drawbacks: A small ringing may appear if the bandwidth of the application is already high.

Network 1 is used for applications requiring a high bandwidth. It corrects two kinds of smear:

- Static smear: visible after a “white box” on a black background (or the opposite). This is corrected with C1 // R1.
- Dynamic smear: visible after a “high frequency pattern” box (1 pixel on 1 pixel off). This is corrected with C2.

2.1.2 Effects

The following waveforms (Figures 4 and 5) show the video signal on the Red channel, both on the input of the amplifier and on the cathode.

Figure 3: Red signals with network 1

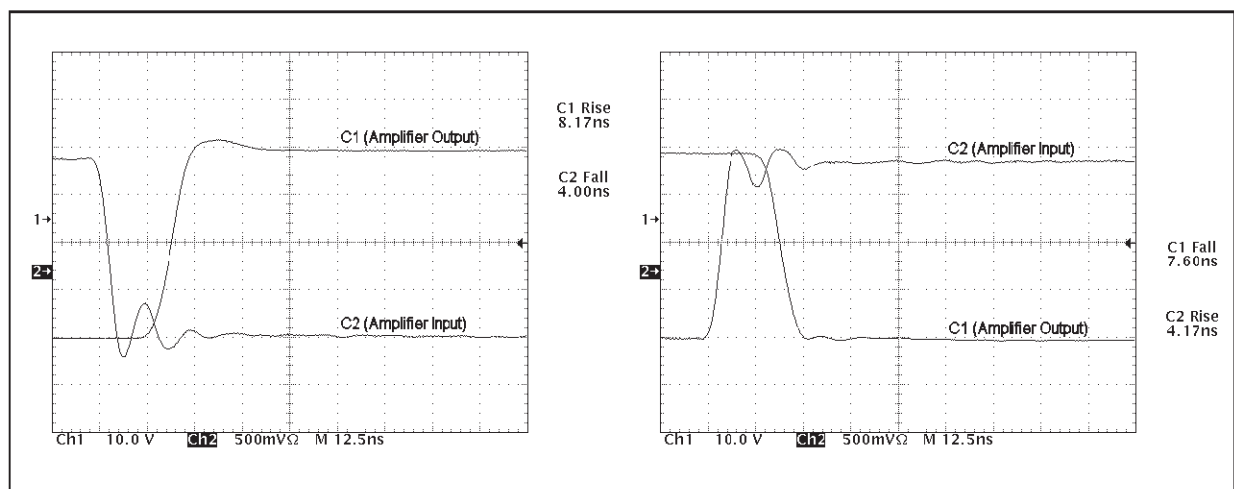

2.2 Network 2

2.2.1 Description

Figure 4: Network 2

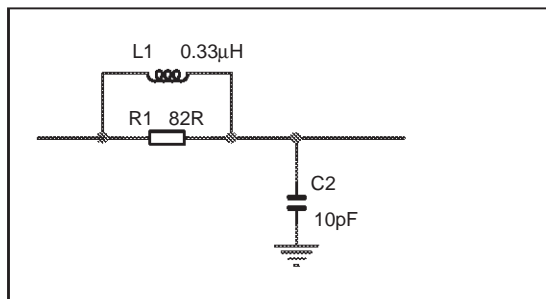

- The coil L1 reduces the high bandwidth phenomena, which may disturb the preamp.
- The capacitor C2 is used to increase the effect of the coil and to add a high frequency peaking.

Advantages: Drastically reduces the high frequency perturbations affecting either the amplifier or the preamplifier.

Drawbacks: Slightly reduces the system bandwidth.

This network is useful in case of rebound effect (after the overshoot) or in case of high bandwidth cross talk.

If some high frequency parasites affect the video performance, using this kind of network can drastically increase the video quality.

2.2.2 Effects

The following waveforms (Figure 7 and 8) show the video signal on the Red channel, both on the input of the amplifier and on the cathode.

Figure 5: Red signals with network 2

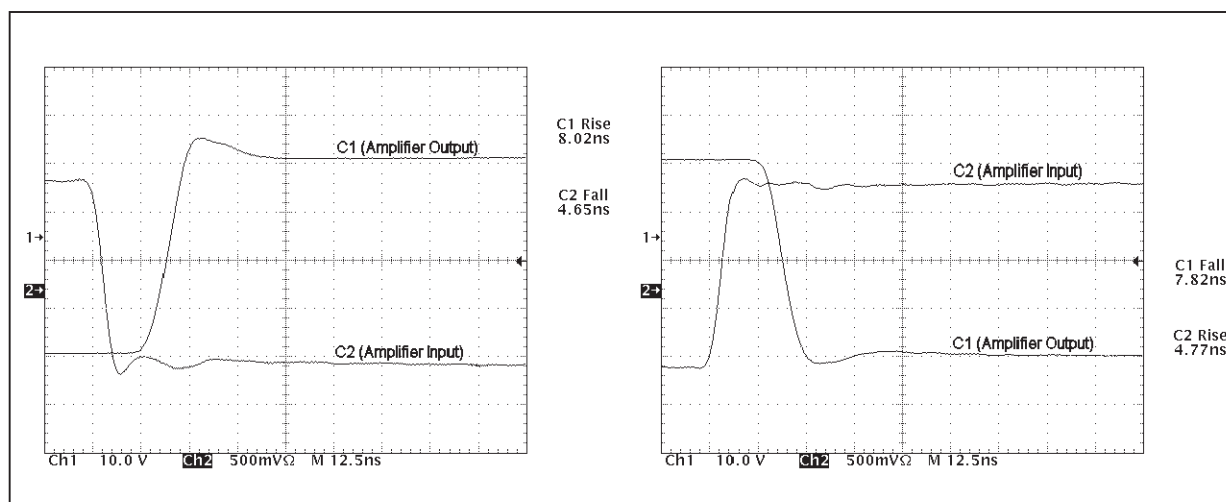

2.3 Network 3

2.3.1 Description

Figure 6: Network 3

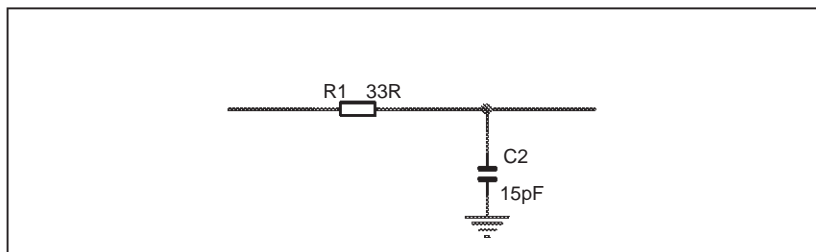

- The capacitor C2 is used to slightly increase the bandwidth. It also corrects a potential dynamic smear by adding a high frequency peaking.
- The resistor R1 must match C2 to adjust the peaking without degrading the bandwidth of the system

Advantages: Slightly increases the system bandwidth and corrects the dynamic smear.

Drawbacks: A good balance between the resistor and the capacitor is necessary to achieve the right effect. Otherwise, network 3 will create the opposite effect.

This network can be used in many applications to slightly increase the bandwidth and improve the video quality without modifying the resistors or coils at the amplifier outputs.

2.3.2 Effects

The following waveforms (figures 10 and 11) show the video signal on the Red channel, both on the input of the amplifier and on the cathode.

Figure 7: Red signals with network 3

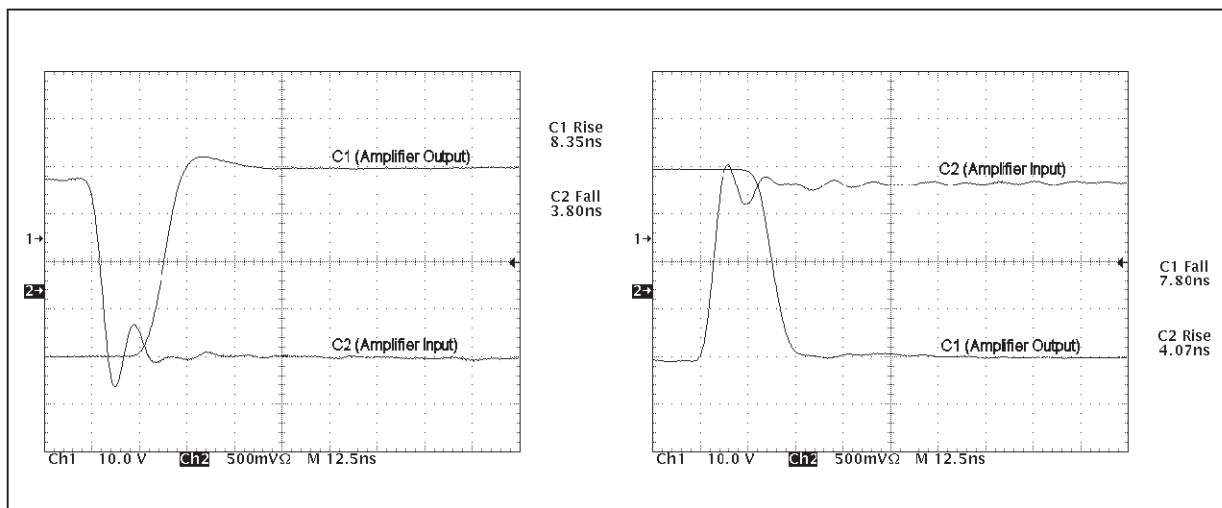

3 Test board schematics

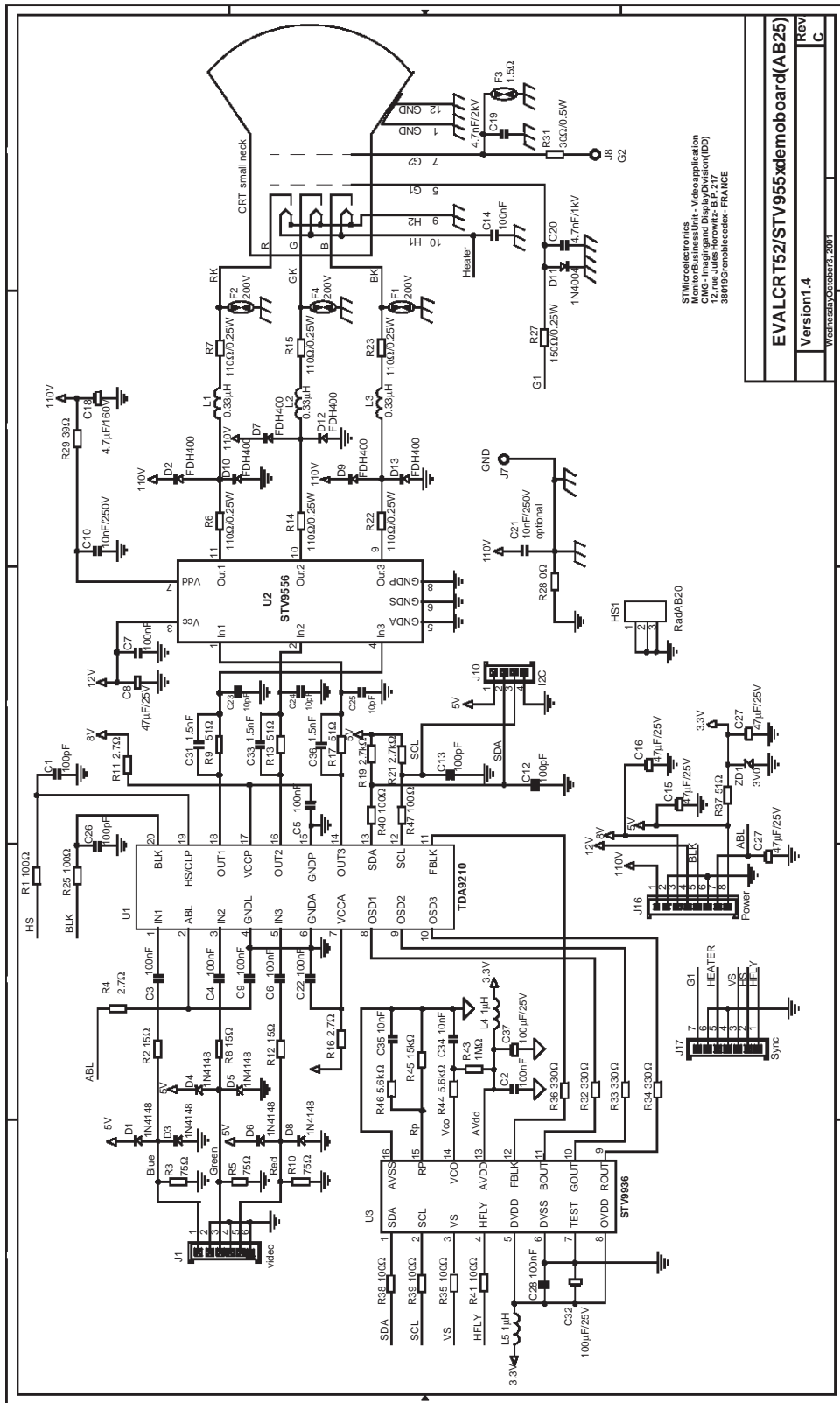

4 Test board layout

Figure 8: STV95XX test board

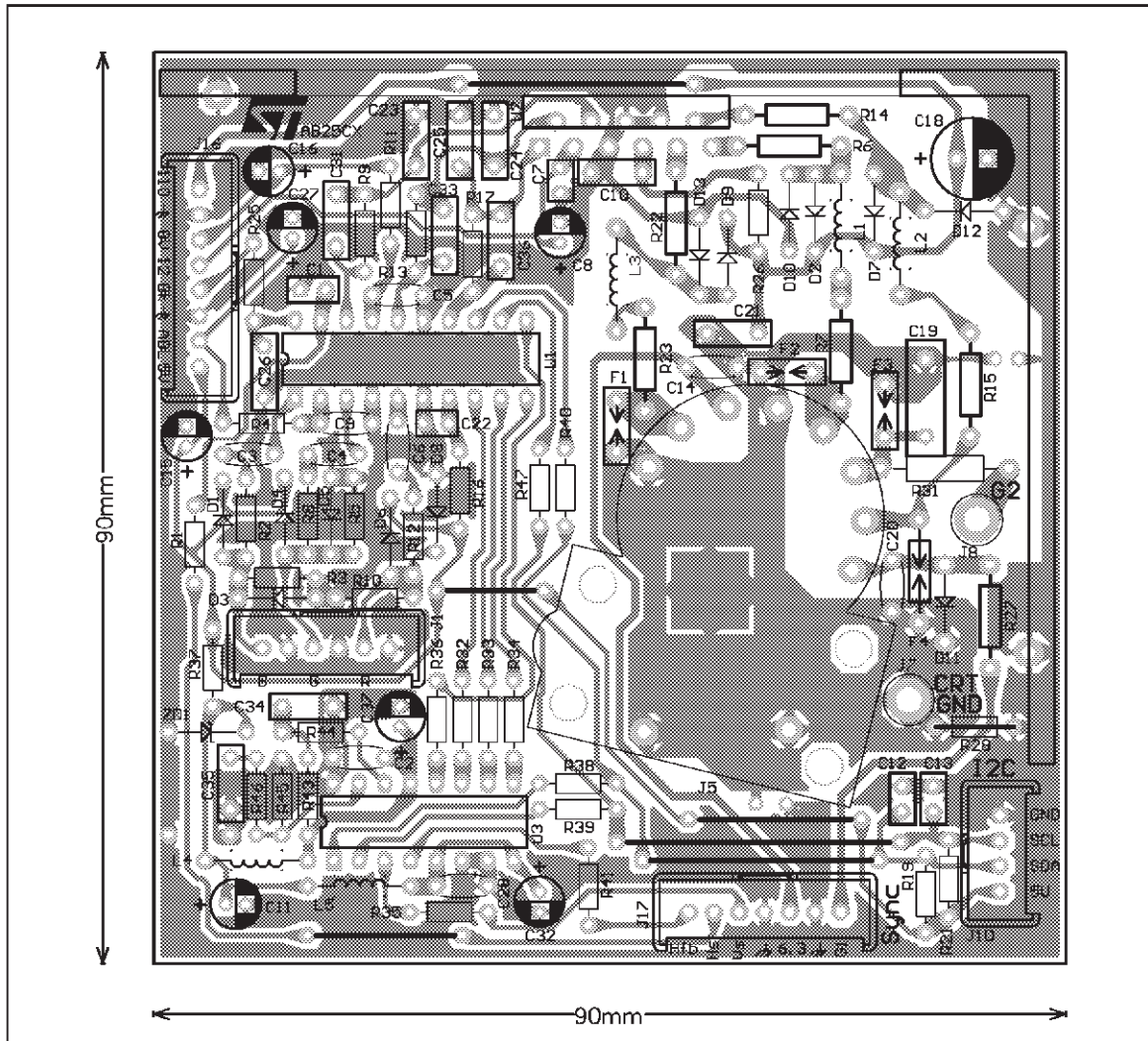

Information furnished is believed to be accurate and reliable. However, STMicroelectronics assumes no responsibility for the consequences of use of such information nor for any infringement of patents or other rights of third parties which may result from its use. No license is granted by implication or otherwise under any patent or patent rights of STMicroelectronics. Specifications mentioned in this publication are subject to change without notice. This publication supersedes and replaces all information previously supplied. STMicroelectronics products are not authorized for use as critical components in life support devices or systems without express written approval of STMicroelectronics.

The ST logo is a registered trademark of STMicroelectronics

© 2002 STMicroelectronics - All Rights Reserved

STMicroelectronics GROUP OF COMPANIES

Australia - Brazil - Canada - China - Finland - France - Germany - Hong Kong - India - Israel -Italy - Japan - Malaysia - Malta-
Morocco - Singapore - Spain - Sweden - Switzerland - United Kingdom - United States

www.st.com