

Features

- Utilizes the AVR[®] RISC Architecture
- High-performance and Low-power 8-bit RISC Architecture
 - 90 Powerful Instructions – Most Single Clock Cycle Execution
 - 32 x 8 General Purpose Working Registers
 - Up to 8 MIPS Throughput at 8 MHz
- Nonvolatile Program and Data Memory
 - 1K Byte of Flash Program Memory
 - In-System Programmable (ATtiny12)
 - Endurance: 1,000 Write/Erase Cycles (ATtiny11/12)
 - 64 Bytes of In-System Programmable EEPROM Data Memory for ATtiny12
 - Endurance: 100,000 Write/Erase Cycles
 - Programming Lock for Flash Program and EEPROM Data Security
- Peripheral Features
 - Interrupt and Wake-up on Pin Change
 - One 8-bit Timer/Counter with Separate Prescaler
 - On-chip Analog Comparator
 - Programmable Watchdog Timer with On-chip Oscillator
- Special Microcontroller Features
 - Low-power Idle and Power-down Modes
 - External and Internal Interrupt Sources
 - In-System Programmable via SPI Port (ATtiny12)
 - Enhanced Power-on Reset Circuit (ATtiny12)
 - Internal Calibrated RC Oscillator (ATtiny12)
- Specification
 - Low-power, High-speed CMOS Process Technology
 - Fully Static Operation
- Power Consumption at 4 MHz, 3V, 25°C
 - Active: 2.2 mA
 - Idle Mode: 0.5 mA
 - Power-down Mode: <1 μA
- Packages
 - 8-pin PDIP and SOIC
- Operating Voltages
 - 1.8 - 5.5V for ATtiny12V-1
 - 2.7 - 5.5V for ATtiny11L-2 and ATtiny12L-4
 - 4.0 - 5.5V for ATtiny11-6 and ATtiny12-8
- Speed Grades
 - 0 - 1.2 MHz (ATtiny12V-1)
 - 0 - 2 MHz (ATtiny11L-2)
 - 0 - 4 MHz (ATtiny12L-4)
 - 0 - 6 MHz (ATtiny11-6)
 - 0 - 8 MHz (ATtiny12-8)

Pin Configuration

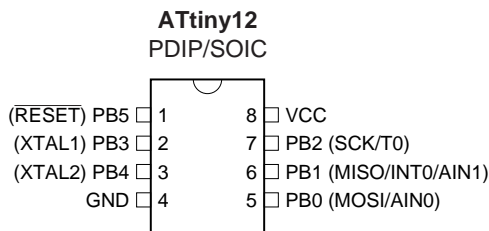
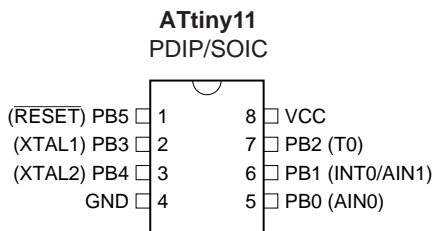

8-bit AVR[®] Microcontroller with 1K Byte Flash

ATtiny11
ATtiny12

Summary

Rev. 1006DS-AVR-07/03



Note: This is a summary document. A complete document is available on our web site at www.atmel.com.



Description

The ATtiny11/12 is a low-power CMOS 8-bit microcontroller based on the AVR RISC architecture. By executing powerful instructions in a single clock cycle, the ATtiny11/12 achieves throughputs approaching 1 MIPS per MHz, allowing the system designer to optimize power consumption versus processing speed.

The AVR core combines a rich instruction set with 32 general-purpose working registers. All the 32 registers are directly connected to the Arithmetic Logic Unit (ALU), allowing two independent registers to be accessed in one single instruction executed in one clock cycle. The resulting architecture is more code efficient while achieving throughputs up to ten times faster than conventional CISC microcontrollers.

Table 1. Parts Description

Device	Flash	EEPROM	Register	Voltage Range	Frequency
ATtiny11L	1K	-	32	2.7 - 5.5V	0-2 MHz
ATtiny11	1K	-	32	4.0 - 5.5V	0-6 MHz
ATtiny12V	1K	64 B	32	1.8 - 5.5V	0-1.2 MHz
ATtiny12L	1K	64 B	32	2.7 - 5.5V	0-4 MHz
ATtiny12	1K	64 B	32	4.0 - 5.5V	0-8 MHz

ATtiny11 Block Diagram

The ATtiny11 provides the following features: 1K bytes of Flash, up to five general-purpose I/O lines, one input line, 32 general-purpose working registers, an 8-bit timer/counter, internal and external interrupts, programmable Watchdog Timer with internal oscillator, and two software-selectable power-saving modes. The Idle Mode stops the CPU while allowing the timer/counters and interrupt system to continue functioning. The Power-down Mode saves the register contents but freezes the oscillator, disabling all other chip functions until the next interrupt or hardware reset. The wake-up or interrupt on pin change features enable the ATtiny11 to be highly responsive to external events, still featuring the lowest power consumption while in the power-down modes.

The device is manufactured using Atmel's high-density nonvolatile memory technology. By combining an RISC 8-bit CPU with Flash on a monolithic chip, the Atmel ATtiny11 is a powerful microcontroller that provides a highly-flexible and cost-effective solution to many embedded control applications.

The ATtiny11 AVR is supported with a full suite of program and system development tools including: macro assemblers, program debugger/simulators, in-circuit emulators, and evaluation kits.

Figure 1. The ATtiny11 Block Diagram

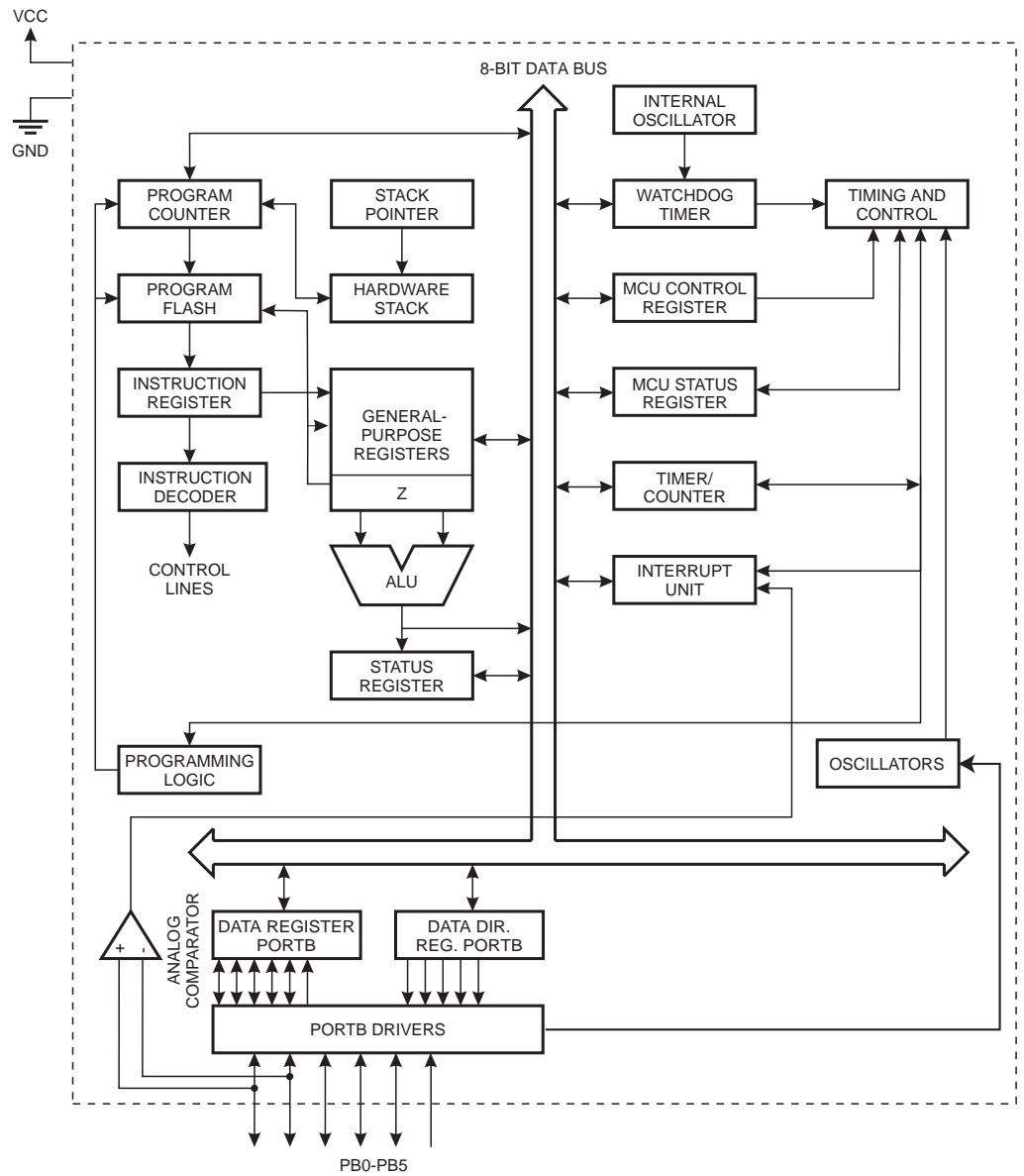

ATtiny12 Block Diagram

Figure 2. The ATtiny12 Block Diagram

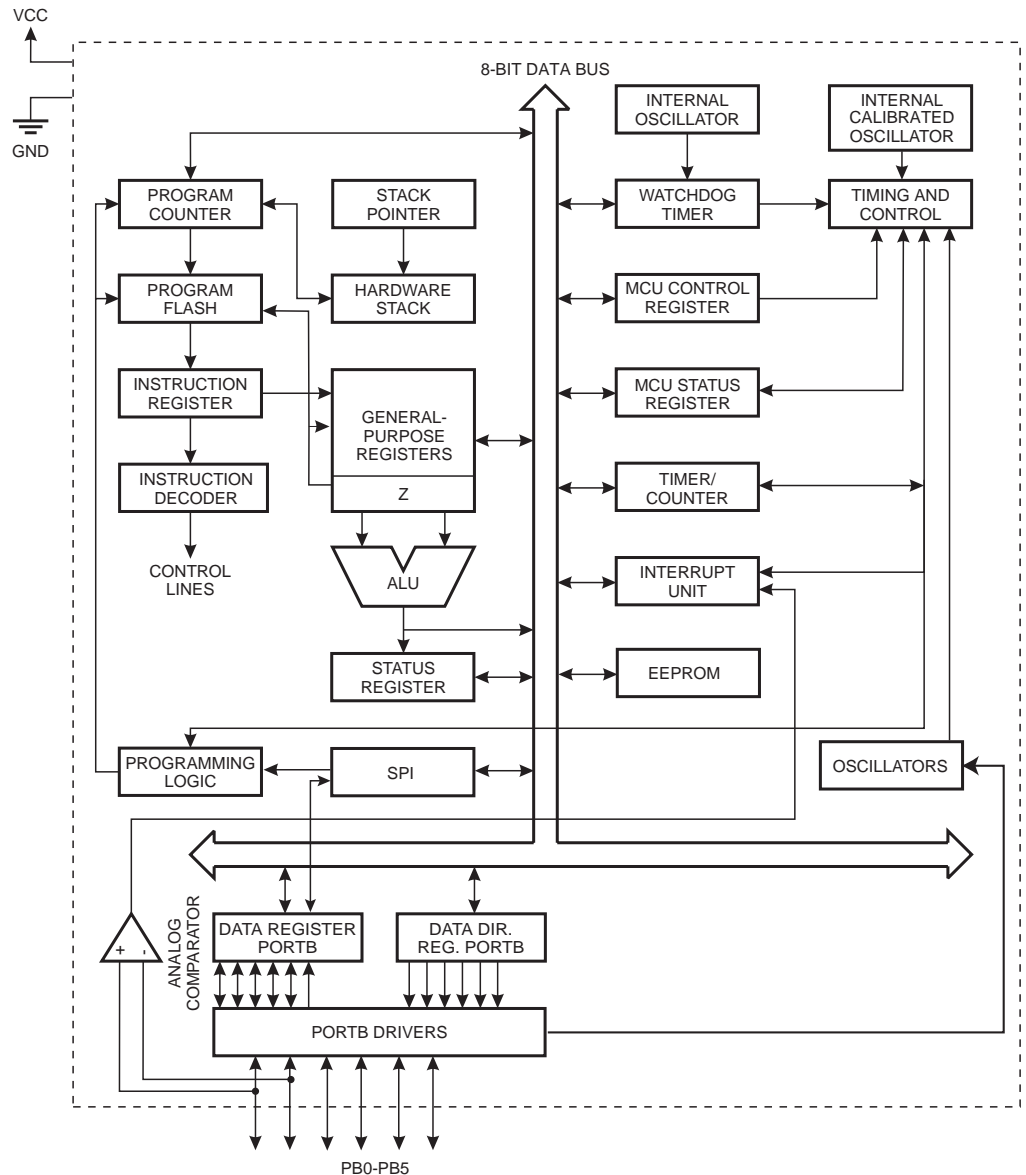

The ATtiny12 provides the following features: 1K bytes of Flash, 64 bytes EEPROM, up to six general-purpose I/O lines, 32 general-purpose working registers, an 8-bit timer/counter, internal and external interrupts, programmable Watchdog Timer with internal oscillator, and two software-selectable power-saving modes. The Idle Mode stops the CPU while allowing the timer/counters and interrupt system to continue functioning. The Power-down Mode saves the register contents but freezes the oscillator, disabling all other chip functions until the next interrupt or hardware reset. The wake-up or interrupt on pin change features enable the ATtiny12 to be highly responsive to external events, still featuring the lowest power consumption while in the power-down modes.

The device is manufactured using Atmel's high-density nonvolatile memory technology. By combining an RISC 8-bit CPU with Flash on a monolithic chip, the Atmel ATtiny12 is a powerful microcontroller that provides a highly-flexible and cost-effective solution to many embedded control applications.

The ATtiny12 AVR is supported with a full suite of program and system development tools including: macro assemblers, program debugger/simulators, in-circuit emulators, and evaluation kits.

Pin Descriptions

VCC Supply voltage pin.

GND Ground pin.

Port B (PB5..PB0) Port B is a 6-bit I/O port. PB4..0 are I/O pins that can provide internal pull-ups (selected for each bit). On ATtiny11, PB5 is input only. On ATtiny12, PB5 is input or open-drain output. The port pins are tri-stated when a reset condition becomes active, even if the clock is not running. The use of pins PB5..3 as input or I/O pins is limited, depending on reset and clock settings, as shown below.

Table 2. PB5..PB3 Functionality vs. Device Clocking Options

Device Clocking Option	PB5	PB4	PB3
External Reset Enabled	Used ⁽¹⁾	-(²⁾	-
External Reset Disabled	Input ⁽³⁾ /I/O ⁽⁴⁾	-	-
External Crystal	-	Used	Used
External Low-frequency Crystal	-	Used	Used
External Ceramic Resonator	-	Used	Used
External RC Oscillator	-	I/O ⁽⁵⁾	Used
External Clock	-	I/O	Used
Internal RC Oscillator	-	I/O	I/O

- Notes:
1. "Used" means the pin is used for reset or clock purposes.
 2. "-" means the pin function is unaffected by the option.
 3. Input means the pin is a port input pin.
 4. On ATtiny11, PB5 is input only. On ATtiny12, PB5 is input or open-drain output.
 5. I/O means the pin is a port input/output pin.

XTAL1 Input to the inverting oscillator amplifier and input to the internal clock operating circuit.

XTAL2 Output from the inverting oscillator amplifier.

RESET Reset input. An external reset is generated by a low level on the $\overline{\text{RESET}}$ pin. Reset pulses longer than 50 ns will generate a reset, even if the clock is not running. Shorter pulses are not guaranteed to generate a reset.



Register Summary ATtiny11

Address	Name	Bit 7	Bit 6	Bit 5	Bit 4	Bit 3	Bit 2	Bit 1	Bit 0	Page	
\$3F	SREG	I	T	H	S	V	N	Z	C		
\$3E	Reserved										
\$3D	Reserved										
\$3C	Reserved										
\$3B	GIMSK	-	INT0	PCIE	-	-	-	-	-		
\$3A	GIFR	-	INTF0	PCIF	-	-	-	-	-		
\$39	TIMSK	-	-	-	-	-	-	TOIE0	-		
\$38	TIFR	-	-	-	-	-	-	TOV0	-		
\$37	Reserved										
\$36	Reserved										
\$35	MCUCR	-	-	SE	SM	-	-	ISC01	ISC00		
\$34	MCUSR	-	-	-	-	-	-	EXTRF	PORF		
\$33	TCCR0	-	-	-	-	-	CS02	CS01	CS00		
\$32	TCNT0	Timer/Counter0 (8 Bit)									
\$31	Reserved										
\$30	Reserved										
...	Reserved										
\$22	Reserved										
\$21	WDTCR	-	-	-	WDTOE	WDE	WDP2	WDP1	WDP0		
\$20	Reserved										
\$1F	Reserved										
\$1E	Reserved										
\$1D	Reserved										
\$1C	Reserved										
\$1B	Reserved										
\$1A	Reserved										
\$19	Reserved										
\$18	PORTB	-	-	-	PORTB4	PORTB3	PORTB2	PORTB1	PORTB0		
\$17	DDRB	-	-	-	DDB4	DDB3	DDB2	DDB1	DDB0		
\$16	PINB	-	-	PINB5	PINB4	PINB3	PINB2	PINB1	PINB0		
\$15	Reserved										
...	Reserved										
\$0A	Reserved										
\$09	Reserved										
\$08	ACSR	ACD	-	ACO	ACI	ACIE	-	ACIS1	ACIS0		
...	Reserved										
\$00	Reserved										

- Notes:
1. For compatibility with future devices, reserved bits should be written to zero if accessed. Reserved I/O memory addresses should never be written.
 2. Some of the status flags are cleared by writing a logical one to them. Note that the CBI and SBI instructions will operate on all bits in the I/O register, writing a one back into any flag read as set, thus clearing the flag. The CBI and SBI instructions work with registers \$00 to \$1F only.

Register Summary ATtiny12

Address	Name	Bit 7	Bit 6	Bit 5	Bit 4	Bit 3	Bit 2	Bit 1	Bit 0	Page
\$3F	SREG	I	T	H	S	V	N	Z	C	
\$3E	Reserved									
\$3D	Reserved									
\$3C	Reserved									
\$3B	GIMSK	-	INT0	PCIE	-	-	-	-	-	
\$3A	GIFR	-	INTF0	PCIF	-	-	-	-	-	
\$39	TIMSK	-	-	-	-	-	-	TOIE0	-	
\$38	TIFR	-	-	-	-	-	-	TOV0	-	
\$37	Reserved									
\$36	Reserved									
\$35	MCUCR	-	PUD	SE	SM	-	-	ISC01	ISC00	
\$34	MCUSR	-	-	-	-	WDRF	BORF	EXTRF	PORF	
\$33	TCCR0	-	-	-	-	-	CS02	CS01	CS00	
\$32	TCNT0	Timer/Counter0 (8 Bit)								
\$31	OSCCAL	Oscillator Calibration Register								
\$30	Reserved									
...	Reserved									
\$22	Reserved									
\$21	WDTCR	-	-	-	WDTOE	WDE	WDP2	WDP1	WDP0	
\$20	Reserved									
\$1F	Reserved									
\$1E	EEAR	-	-	EEPROM Address Register						
\$1D	EEDR	EEPROM Data Register								
\$1C	EECR	-	-	-	-	EERIE	EEMWE	EWE	EERE	
\$1B	Reserved									
\$1A	Reserved									
\$19	Reserved									
\$18	PORTB	-	-	-	PORTB4	PORTB3	PORTB2	PORTB1	PORTB0	
\$17	DDRB	-	-	DDB5	DDB4	DDB3	DDB2	DDB1	DDB0	
\$16	PINB	-	-	PINB5	PINB4	PINB3	PINB2	PINB1	PINB0	
\$15	Reserved									
...	Reserved									
\$0A	Reserved									
\$09	Reserved									
\$08	ACSR	ACD	AINBG	ACO	ACI	ACIE	-	ACIS1	ACIS0	
...	Reserved									
\$00	Reserved									

- Note:
1. For compatibility with future devices, reserved bits should be written to zero if accessed. Reserved I/O memory addresses should never be written.
 2. Some of the status flags are cleared by writing a logical one to them. Note that the CBI and SBI instructions will operate on all bits in the I/O register, writing a one back into any flag read as set, thus clearing the flag. The CBI and SBI instructions work with registers \$00 to \$1F only.



Instruction Set Summary

Mnemonics	Operands	Description	Operation	Flags	#Clocks
ARITHMETIC AND LOGIC INSTRUCTIONS					
ADD	Rd, Rr	Add two Registers	$Rd \leftarrow Rd + Rr$	Z,C,N,V,H	1
ADC	Rd, Rr	Add with Carry two Registers	$Rd \leftarrow Rd + Rr + C$	Z,C,N,V,H	1
SUB	Rd, Rr	Subtract two Registers	$Rd \leftarrow Rd - Rr$	Z,C,N,V,H	1
SUBI	Rd, K	Subtract Constant from Register	$Rd \leftarrow Rd - K$	Z,C,N,V,H	1
SBC	Rd, Rr	Subtract with Carry two Registers	$Rd \leftarrow Rd - Rr - C$	Z,C,N,V,H	1
SBCI	Rd, K	Subtract with Carry Constant from Reg.	$Rd \leftarrow Rd - K - C$	Z,C,N,V,H	1
AND	Rd, Rr	Logical AND Registers	$Rd \leftarrow Rd \cdot Rr$	Z,N,V	1
ANDI	Rd, K	Logical AND Register and Constant	$Rd \leftarrow Rd \cdot K$	Z,N,V	1
OR	Rd, Rr	Logical OR Registers	$Rd \leftarrow Rd \vee Rr$	Z,N,V	1
ORI	Rd, K	Logical OR Register and Constant	$Rd \leftarrow Rd \vee K$	Z,N,V	1
EOR	Rd, Rr	Exclusive OR Registers	$Rd \leftarrow Rd \oplus Rr$	Z,N,V	1
COM	Rd	One's Complement	$Rd \leftarrow \text{\$FF} - Rd$	Z,C,N,V	1
NEG	Rd	Two's Complement	$Rd \leftarrow \text{\$00} - Rd$	Z,C,N,V,H	1
SBR	Rd,K	Set Bit(s) in Register	$Rd \leftarrow Rd \vee K$	Z,N,V	1
CBR	Rd,K	Clear Bit(s) in Register	$Rd \leftarrow Rd \cdot (\text{FFh} - K)$	Z,N,V	1
INC	Rd	Increment	$Rd \leftarrow Rd + 1$	Z,N,V	1
DEC	Rd	Decrement	$Rd \leftarrow Rd - 1$	Z,N,V	1
TST	Rd	Test for Zero or Minus	$Rd \leftarrow Rd \cdot Rd$	Z,N,V	1
CLR	Rd	Clear Register	$Rd \leftarrow Rd \oplus Rd$	Z,N,V	1
SER	Rd	Set Register	$Rd \leftarrow \text{\$FF}$	None	1
BRANCH INSTRUCTIONS					
RJMP	k	Relative Jump	$PC \leftarrow PC + k + 1$	None	2
RCALL	k	Relative Subroutine Call	$PC \leftarrow PC + k + 1$	None	3
RET		Subroutine Return	$PC \leftarrow \text{STACK}$	None	4
RETI		Interrupt Return	$PC \leftarrow \text{STACK}$	I	4
CPSE	Rd,Rr	Compare, Skip if Equal	if (Rd = Rr) $PC \leftarrow PC + 2$ or 3	None	1/2
CP	Rd,Rr	Compare	$Rd - Rr$	Z, N, V, C, H	1
CPC	Rd,Rr	Compare with Carry	$Rd - Rr - C$	Z, N, V, C, H	1
CPI	Rd,K	Compare Register with Immediate	$Rd - K$	Z, N, V, C, H	1
SBRC	Rr, b	Skip if Bit in Register Cleared	if (Rr(b)=0) $PC \leftarrow PC + 2$ or 3	None	1/2
SBRs	Rr, b	Skip if Bit in Register is Set	if (Rr(b)=1) $PC \leftarrow PC + 2$ or 3	None	1/2
SBIC	P, b	Skip if Bit in I/O Register Cleared	if (P(b)=0) $PC \leftarrow PC + 2$ or 3	None	1/2
SBIS	P, b	Skip if Bit in I/O Register is Set	if (P(b)=1) $PC \leftarrow PC + 2$ or 3	None	1/2
BRBS	s, k	Branch if Status Flag Set	if (SREG(s) = 1) then $PC \leftarrow PC + k + 1$	None	1/2
BRBC	s, k	Branch if Status Flag Cleared	if (SREG(s) = 0) then $PC \leftarrow PC + k + 1$	None	1/2
BREQ	k	Branch if Equal	if (Z = 1) then $PC \leftarrow PC + k + 1$	None	1/2
BRNE	k	Branch if Not Equal	if (Z = 0) then $PC \leftarrow PC + k + 1$	None	1/2
BRCS	k	Branch if Carry Set	if (C = 1) then $PC \leftarrow PC + k + 1$	None	1/2
BRCC	k	Branch if Carry Cleared	if (C = 0) then $PC \leftarrow PC + k + 1$	None	1/2
BRSH	k	Branch if Same or Higher	if (C = 0) then $PC \leftarrow PC + k + 1$	None	1/2
BRLO	k	Branch if Lower	if (C = 1) then $PC \leftarrow PC + k + 1$	None	1/2
BRMI	k	Branch if Minus	if (N = 1) then $PC \leftarrow PC + k + 1$	None	1/2
BRPL	k	Branch if Plus	if (N = 0) then $PC \leftarrow PC + k + 1$	None	1/2
BRGE	k	Branch if Greater or Equal, Signed	if (N \oplus V = 0) then $PC \leftarrow PC + k + 1$	None	1/2
BRLT	k	Branch if Less Than Zero, Signed	if (N \oplus V = 1) then $PC \leftarrow PC + k + 1$	None	1/2
BRHS	k	Branch if Half Carry Flag Set	if (H = 1) then $PC \leftarrow PC + k + 1$	None	1/2
BRHC	k	Branch if Half Carry Flag Cleared	if (H = 0) then $PC \leftarrow PC + k + 1$	None	1/2
BRTS	k	Branch if T Flag Set	if (T = 1) then $PC \leftarrow PC + k + 1$	None	1/2
BRTC	k	Branch if T Flag Cleared	if (T = 0) then $PC \leftarrow PC + k + 1$	None	1/2
BRVS	k	Branch if Overflow Flag is Set	if (V = 1) then $PC \leftarrow PC + k + 1$	None	1/2
BRVC	k	Branch if Overflow Flag is Cleared	if (V = 0) then $PC \leftarrow PC + k + 1$	None	1/2
BRIE	k	Branch if Interrupt Enabled	if (I = 1) then $PC \leftarrow PC + k + 1$	None	1/2
BRID	k	Branch if Interrupt Disabled	if (I = 0) then $PC \leftarrow PC + k + 1$	None	1/2

Instruction Set Summary (Continued)

Mnemonics	Operands	Description	Operation	Flags	#Clocks
DATA TRANSFER INSTRUCTIONS					
LD	Rd,Z	Load Register Indirect	$Rd \leftarrow (Z)$	None	2
ST	Z,Rr	Store Register Indirect	$(Z) \leftarrow Rr$	None	2
MOV	Rd, Rr	Move Between Registers	$Rd \leftarrow Rr$	None	1
LDI	Rd, K	Load Immediate	$Rd \leftarrow K$	None	1
IN	Rd, P	In Port	$Rd \leftarrow P$	None	1
OUT	P, Rr	Out Port	$P \leftarrow Rr$	None	1
LPM		Load Program Memory	$R0 \leftarrow (Z)$	None	3
BIT AND BIT-TEST INSTRUCTIONS					
SBI	P,b	Set Bit in I/O Register	$I/O(P,b) \leftarrow 1$	None	2
CBI	P,b	Clear Bit in I/O Register	$I/O(P,b) \leftarrow 0$	None	2
LSL	Rd	Logical Shift Left	$Rd(n+1) \leftarrow Rd(n), Rd(0) \leftarrow 0$	Z,C,N,V	1
LSR	Rd	Logical Shift Right	$Rd(n) \leftarrow Rd(n+1), Rd(7) \leftarrow 0$	Z,C,N,V	1
ROL	Rd	Rotate Left Through Carry	$Rd(0) \leftarrow C, Rd(n+1) \leftarrow Rd(n), C \leftarrow Rd(7)$	Z,C,N,V	1
ROR	Rd	Rotate Right Through Carry	$Rd(7) \leftarrow C, Rd(n) \leftarrow Rd(n+1), C \leftarrow Rd(0)$	Z,C,N,V	1
ASR	Rd	Arithmetic Shift Right	$Rd(n) \leftarrow Rd(n+1), n = 0..6$	Z,C,N,V	1
SWAP	Rd	Swap Nibbles	$Rd(3..0) \leftarrow Rd(7..4), Rd(7..4) \leftarrow Rd(3..0)$	None	1
BSET	s	Flag Set	$SREG(s) \leftarrow 1$	SREG(s)	1
BCLR	s	Flag Clear	$SREG(s) \leftarrow 0$	SREG(s)	1
BST	Rr, b	Bit Store from Register to T	$T \leftarrow Rr(b)$	T	1
BLD	Rd, b	Bit load from T to Register	$Rd(b) \leftarrow T$	None	1
SEC		Set Carry	$C \leftarrow 1$	C	1
CLC		Clear Carry	$C \leftarrow 0$	C	1
SEN		Set Negative Flag	$N \leftarrow 1$	N	1
CLN		Clear Negative Flag	$N \leftarrow 0$	N	1
SEZ		Set Zero Flag	$Z \leftarrow 1$	Z	1
CLZ		Clear Zero Flag	$Z \leftarrow 0$	Z	1
SEI		Global Interrupt Enable	$I \leftarrow 1$	I	1
CLI		Global Interrupt Disable	$I \leftarrow 0$	I	1
SES		Set Signed Test Flag	$S \leftarrow 1$	S	1
CLS		Clear Signed Test Flag	$S \leftarrow 0$	S	1
SEV		Set Twos Complement Overflow	$V \leftarrow 1$	V	1
CLV		Clear Twos Complement Overflow	$V \leftarrow 0$	V	1
SET		Set T in SREG	$T \leftarrow 1$	T	1
CLT		Clear T in SREG	$T \leftarrow 0$	T	1
SEH		Set Half Carry Flag in SREG	$H \leftarrow 1$	H	1
CLH		Clear Half Carry Flag in SREG	$H \leftarrow 0$	H	1
NOP		No Operation		None	1
SLEEP		Sleep	(see specific descr. for Sleep function)	None	1
WDR		Watch Dog Reset	(see specific descr. for WDR/timer)	None	1



Ordering Information

Power Supply	Speed (MHz)	Ordering Code	Package	Operation Range
2.7 - 5.5V	2	ATtiny11L-2PC ATtiny11L-2SC	8P3 8S2	Commercial (0°C to 70°C)
		ATtiny11L-2PI ATtiny11L-2SI	8P3 8S2	Industrial (-40°C to 85°C)
4.0 - 5.5V	6	ATtiny11-6PC ATtiny11-6SC	8P3 8S2	Commercial (0°C to 70°C)
		ATtiny11-6PI ATtiny11-6SI	8P3 8S2	Industrial (-40°C to 85°C)
1.8 - 5.5V	1.2	ATtiny12V-1PC ATtiny12V-1SC	8P3 8S2	Commercial (0°C to 70°C)
		ATtiny12V-1PI ATtiny12V-1SI	8P3 8S2	Industrial (-40°C to 85°C)
2.7 - 5.5V	4	ATtiny12L-4PC ATtiny12L-4SC	8P3 8S2	Commercial (0°C to 70°C)
		ATtiny12L-4PI ATtiny12L-4SI	8P3 8S2	Industrial (-40°C to 85°C)
4.0 - 5.5V	8	ATtiny12-8PC ATtiny12-8SC	8P3 8S2	Commercial (0°C to 70°C)
		ATtiny12-8PI ATtiny12-8SI	8P3 8S2	Industrial (-40°C to 85°C)

Note: The speed grade refers to maximum clock rate when using an external crystal or external clock drive. The internal RC oscillator has the same nominal clock frequency for all speed grades.

Package Type	
8P3	8-lead, 0.300" Wide, Plastic Dual Inline Package (PDIP)
8S2	8-lead, 0.200" Wide, Plastic Gull-Wing Small Outline (EIAJ SOIC)

Packaging Information

8P3

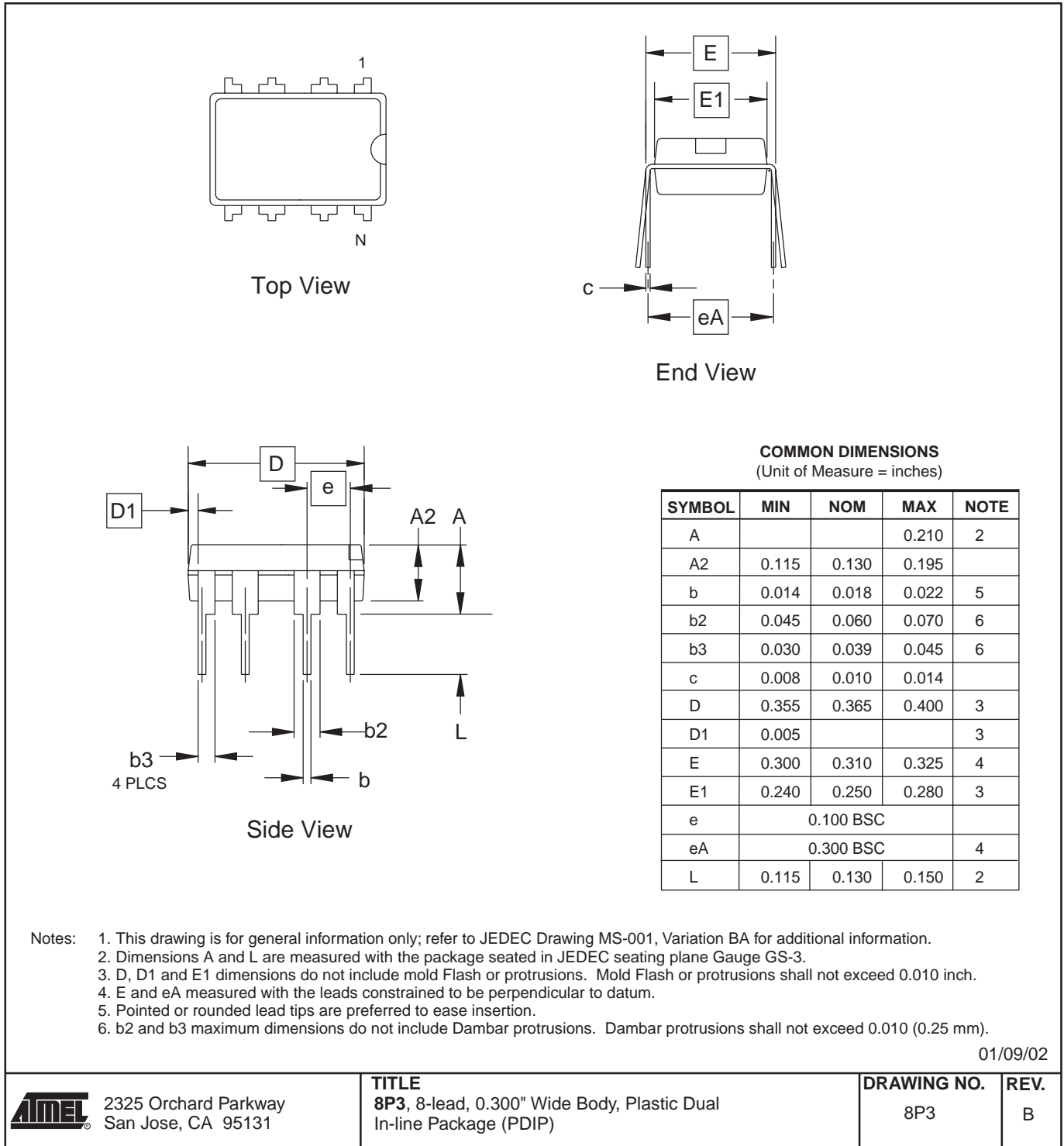

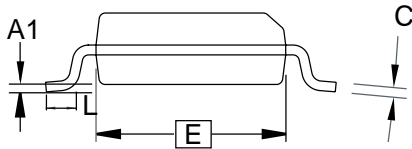
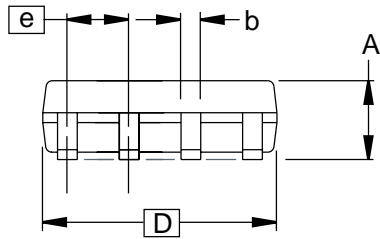
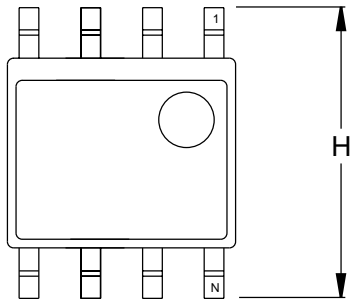

COMMON DIMENSIONS
(Unit of Measure = mm)

SYMBOL	MIN	NOM	MAX	NOTE
A	1.78		2.03	
A1	0.05		0.33	
b	0.35		0.51	5
C	0.18		0.25	5
D	5.13		5.38	
E	5.13		5.41	2, 3
H	7.62		8.38	
L	0.51		0.89	
e	1.27 BSC			4

- Notes: 1. This drawing is for general information only; refer to EIAJ Drawing EDR-7320 for additional information.
 2. Mismatch of the upper and lower dies and resin burrs aren't included.
 3. It is recommended that upper and lower cavities be equal. If they are different, the larger dimension shall be regarded.
 4. Determines the true geometric position.
 5. Values b,C apply to pb/Sn solder plated terminal. The standard thickness of the solder layer shall be 0.010 +0.010/-0.005 mm.

5/2/02

2325 Orchard Parkway
San Jose, CA 95131

TITLE
8S2, 8-lead, 0.209" Body, Plastic Small
Outline Package (EIAJ)

DRAWING NO.
8S2

REV.
B



Atmel Corporation

2325 Orchard Parkway
San Jose, CA 95131
Tel: 1(408) 441-0311
Fax: 1(408) 487-2600

Regional Headquarters

Europe

Atmel Sarl
Route des Arsenalux 41
Case Postale 80
CH-1705 Fribourg
Switzerland
Tel: (41) 26-426-5555
Fax: (41) 26-426-5500

Asia

Room 1219
Chinachem Golden Plaza
77 Mody Road Tsimshatsui
East Kowloon
Hong Kong
Tel: (852) 2721-9778
Fax: (852) 2722-1369

Japan

9F, Tonetsu Shinkawa Bldg.
1-24-8 Shinkawa
Chuo-ku, Tokyo 104-0033
Japan
Tel: (81) 3-3523-3551
Fax: (81) 3-3523-7581

Atmel Operations

Memory

2325 Orchard Parkway
San Jose, CA 95131
Tel: 1(408) 441-0311
Fax: 1(408) 436-4314

Microcontrollers

2325 Orchard Parkway
San Jose, CA 95131
Tel: 1(408) 441-0311
Fax: 1(408) 436-4314

La Chantrerie
BP 70602
44306 Nantes Cedex 3, France
Tel: (33) 2-40-18-18-18
Fax: (33) 2-40-18-19-60

ASIC/ASSP/Smart Cards

Zone Industrielle
13106 Rousset Cedex, France
Tel: (33) 4-42-53-60-00
Fax: (33) 4-42-53-60-01

1150 East Cheyenne Mtn. Blvd.
Colorado Springs, CO 80906
Tel: 1(719) 576-3300
Fax: 1(719) 540-1759

Scottish Enterprise Technology Park
Maxwell Building
East Kilbride G75 0QR, Scotland
Tel: (44) 1355-803-000
Fax: (44) 1355-242-743

RF/Automotive

Theresienstrasse 2
Postfach 3535
74025 Heilbronn, Germany
Tel: (49) 71-31-67-0
Fax: (49) 71-31-67-2340

1150 East Cheyenne Mtn. Blvd.
Colorado Springs, CO 80906
Tel: 1(719) 576-3300
Fax: 1(719) 540-1759

Biometrics/Imaging/Hi-Rel MPU/ High Speed Converters/RF Datacom

Avenue de Rochepleine
BP 123
38521 Saint-Egreve Cedex, France
Tel: (33) 4-76-58-30-00
Fax: (33) 4-76-58-34-80

e-mail

literature@atmel.com

Web Site

<http://www.atmel.com>

Disclaimer: Atmel Corporation makes no warranty for the use of its products, other than those expressly contained in the Company's standard warranty which is detailed in Atmel's Terms and Conditions located on the Company's web site. The Company assumes no responsibility for any errors which may appear in this document, reserves the right to change devices or specifications detailed herein at any time without notice, and does not make any commitment to update the information contained herein. No licenses to patents or other intellectual property of Atmel are granted by the Company in connection with the sale of Atmel products, expressly or by implication. Atmel's products are not authorized for use as critical components in life support devices or systems.

© Atmel Corporation 2003. All rights reserved. Atmel® and combinations thereof, AVR® and AVR Studio® are the registered trademarks of Atmel Corporation or its subsidiaries.

Other terms and product names may be the trademarks of others.



Printed on recycled paper.