

M67781L

135-160MHz, 12.5V, 40W, FM MOBILE RADIO

OUTLINE DRAWING

Dimensions in mm

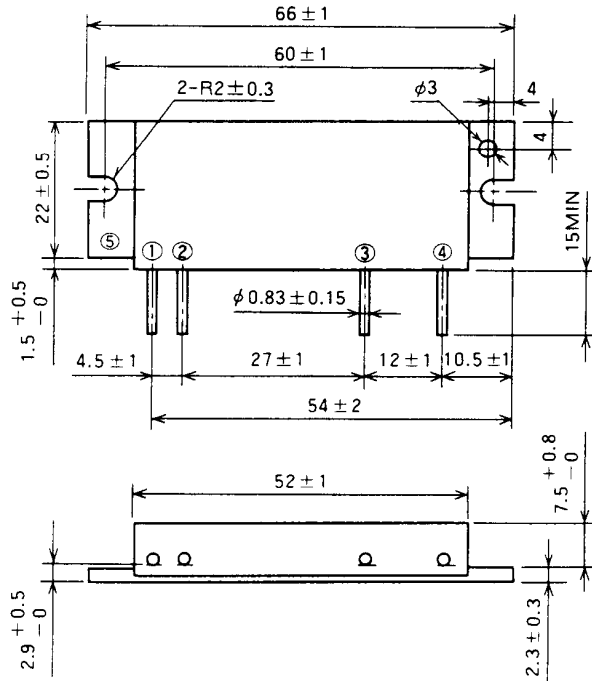

BLOCK DIAGRAM

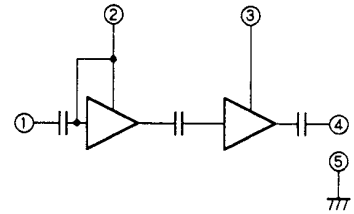

PIN :

- ① Pin : RF INPUT
- ② VCC1 : 1st. DC SUPPLY
- ③ VCC2 : 2nd. DC SUPPLY
- ④ Po : RF OUTPUT
- ⑤ GND : FIN

ABSOLUTE MAXIMUM RATINGS (Tc = 25 °C unless otherwise noted)

Symbol	Parameter	Conditions	Ratings	Unit
VCC1	Supply voltage		16	V
VCC2			17	V
Icc	Total current		12	A
P _{in(max)}	Input power	Z _G = Z _L = 50 Ω, VCC1 ≤ 12.5V	0.6	W
P _{O(max)}	Output power	Z _G = Z _L = 50 Ω	50	W
T _{C(OP)}	Operation case temperature		- 30 to 110	°C
T _{stg}	Storage temperature		- 40 to 110	°C

Note. Above parameters are guaranteed independently.

ELECTRICAL CHARACTERISTICS (Tc = 25 °C unless otherwise noted)

Symbol	Parameter	Test conditions	Limits		Unit
			Min	Max	
f	Frequency range	P _{in} = 0.3W VCC = 12.5V Z _G = Z _L = 50 Ω	135	160	MHz
P _O	Output power		40		W
η _T	Total efficiency		40		%
2fo	2nd. harmonic			- 30	dBc
3fo	3rd. harmonic			- 30	dBc
ρ _{in}	Input VSWR			3.0	-
-	Load VSWR tolerance	VCC = 15.2V, P _O = 40W (P _{in} : controlled) Load VSWR = 8.8:1 (All phase), 5sec. Z _G = 50 Ω	No degradation or destroy		-

Note. Above parameters, ratings, limits and conditions are subject to change.

TYPICAL PERFORMANCE DATA

OUTPUT POWER, TOTAL EFFICIENCY, INPUT VSWR VS. FREQUENCY CHARACTERISTICS

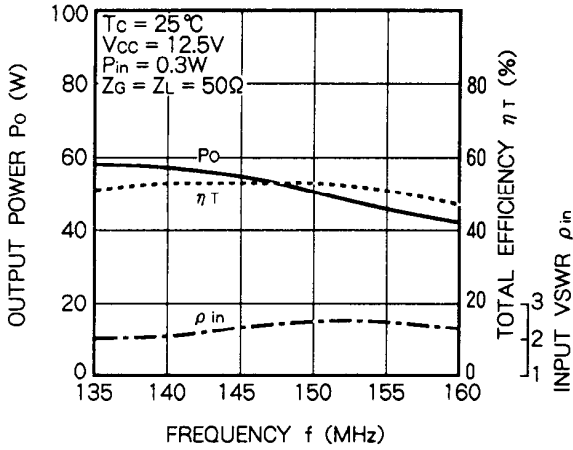

OUTPUT POWER, EACH CURRENT VS. INPUT POWER CHARACTERISTICS

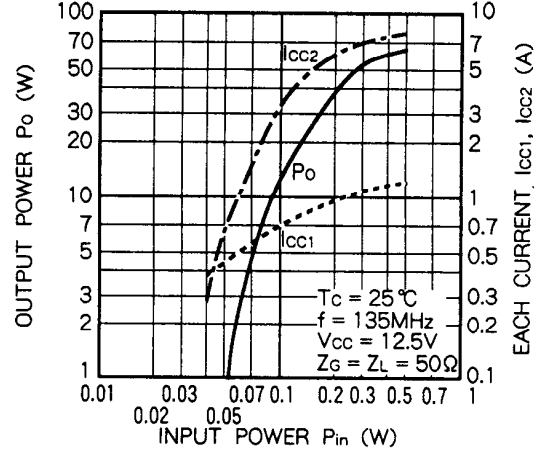

OUTPUT POWER, EACH CURRENT VS. INPUT POWER CHARACTERISTICS

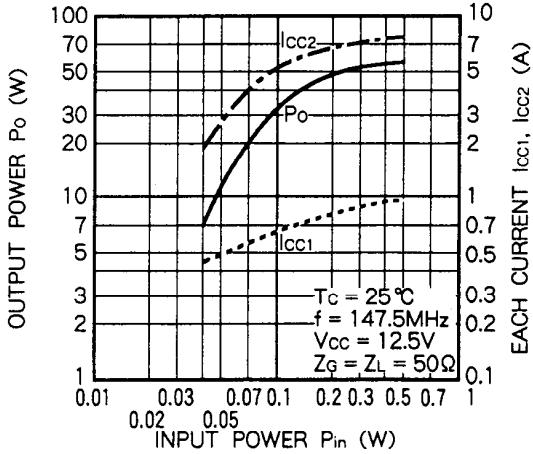

OUTPUT POWER, EACH CURRENT VS. INPUT POWER CHARACTERISTICS

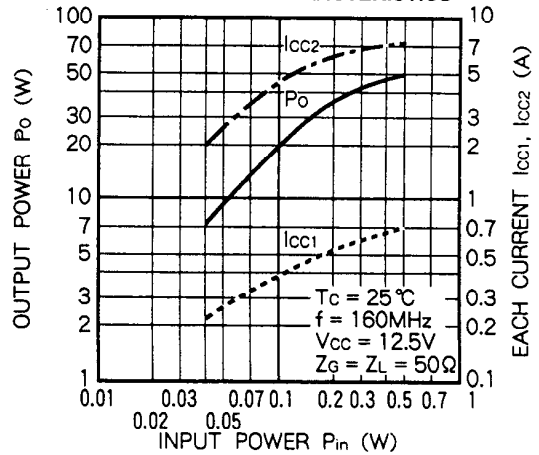

OUTPUT POWER, EACH CURRENT VS. 1st SUPPLY VOLTAGE CHARACTERISTICS

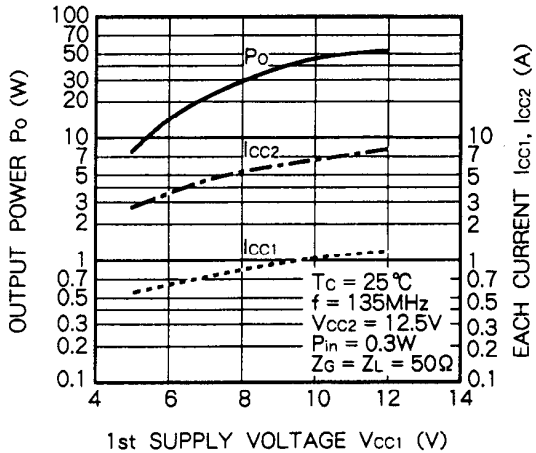

OUTPUT POWER, EACH CURRENT VS. 1st SUPPLY VOLTAGE CHARACTERISTICS

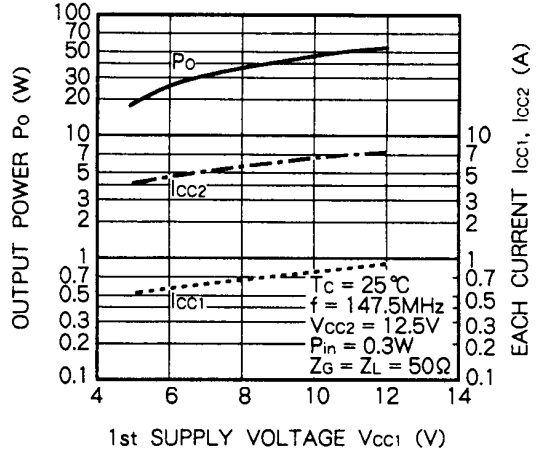

OUTPUT POWER, EACH CURRENT VS. 1st SUPPLY VOLTAGE CHARACTERISTICS

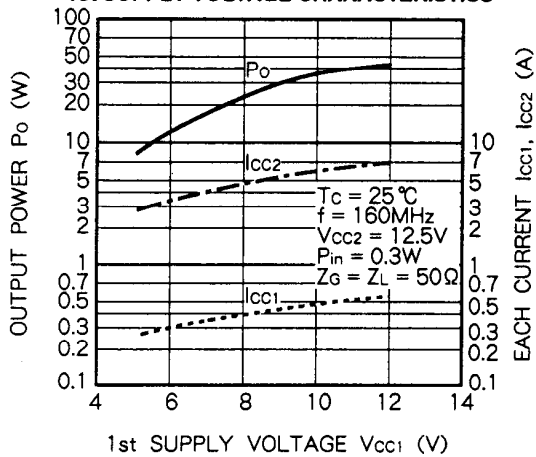

OUTPUT POWER, EACH CURRENT VS. SUPPLY VOLTAGE CHARACTERISTICS

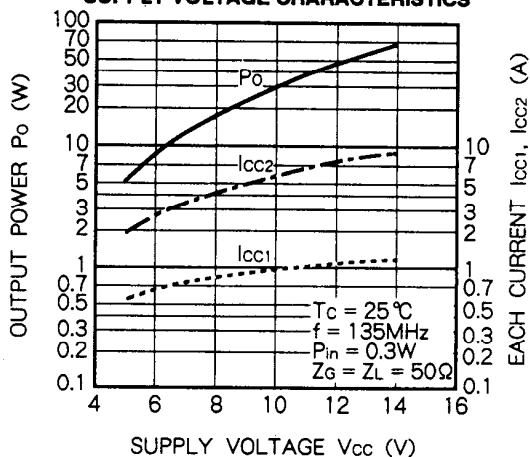

OUTPUT POWER, EACH CURRENT VS. SUPPLY VOLTAGE CHARACTERISTICS

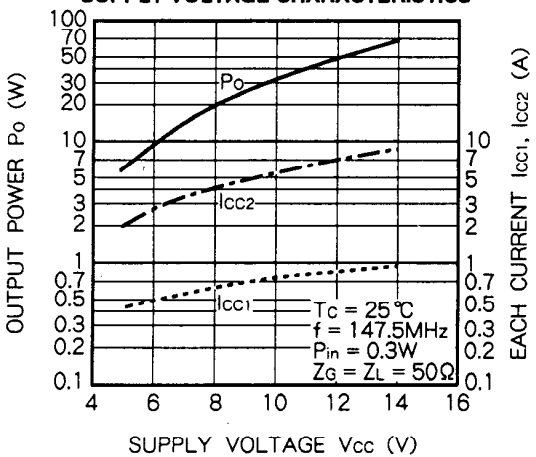

OUTPUT POWER, EACH CURRENT VS. SUPPLY VOLTAGE CHARACTERISTICS

