

# BCM857BV; BCM857BS; BCM857DS

www.DataSheet4U.com

PNP/PNP matched double transistors

Rev. 06 — 28 August 2009

Product data sheet

## 1. Product profile

### 1.1 General description

PNP/PNP matched double transistors in small Surface-Mounted Device (SMD) plastic packages. The transistors are fully isolated internally.

Table 1. Product overview

Type number	Package		NPN/NPN complement	Matched version of
	NXP	JEITA		
BCM857BV	SOT666	-	BCM847BV	BC857BV
BCM857BS	SOT363	SC-88	BCM847BS	BC857BS
BCM857DS	SOT457	SC-74	BCM847DS	-

### 1.2 Features

- Current gain matching
- Base-emitter voltage matching
- Drop-in replacement for standard double transistors

### 1.3 Applications

- Current mirror
- Differential amplifier

### 1.4 Quick reference data

Table 2. Quick reference data

Symbol	Parameter	Conditions	Min	Typ	Max	Unit
<b>Per transistor</b>						
$V_{CE0}$	collector-emitter voltage	open base	-	-	-45	V
$I_C$	collector current		-	-	-100	mA
$h_{FE}$	DC current gain	$V_{CE} = -5\text{ V};$ $I_C = -2\text{ mA}$	200	290	450	



**Table 2. Quick reference data ...continued**

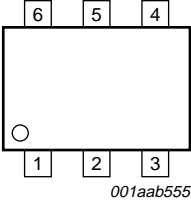
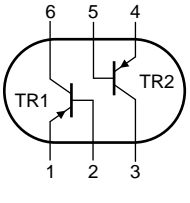
Symbol	Parameter	Conditions	Min	Typ	Max	Unit
<b>Per device</b>						
$h_{FE1}/h_{FE2}$	$h_{FE}$ matching	$V_{CE} = -5\text{ V};$ $I_C = -2\text{ mA}$	[1] 0.9	1	-	
$V_{BE1}-V_{BE2}$	$V_{BE}$ matching	$V_{CE} = -5\text{ V};$ $I_C = -2\text{ mA}$	[2] -	-	2	mV

[1] The smaller of the two values is taken as the numerator.

[2] The smaller of the two values is subtracted from the larger value.

## 2. Pinning information

**Table 3. Pinning**

Pin	Description	Simplified outline	Symbol
1	emitter TR1	 <p>001aab555</p>	 <p>sym018</p>
2	base TR1		
3	collector TR2		
4	emitter TR2		
5	base TR2		
6	collector TR1		

## 3. Ordering information

**Table 4. Ordering information**

Type number	Package		Version
	Name	Description	
BCM857BV	-	plastic surface-mounted package; 6 leads	SOT666
BCM857BS	SC-88	plastic surface-mounted package; 6 leads	SOT363
BCM857DS	SC-74	plastic surface-mounted package (TSOP6); 6 leads	SOT457

## 4. Marking

**Table 5. Marking codes**

Type number	Marking code <sup>[1]</sup>
BCM857BV	3B
BCM857BS	A9*
BCM857DS	R8

[1] \* = -: made in Hong Kong  
 \* = p: made in Hong Kong  
 \* = t: made in Malaysia  
 \* = W: made in China

## 5. Limiting values

**Table 6. Limiting values**
*In accordance with the Absolute Maximum Rating System (IEC 60134).*

Symbol	Parameter	Conditions	Min	Max	Unit	
<b>Per transistor</b>						
$V_{CBO}$	collector-base voltage	open emitter	-	-50	V	
$V_{CEO}$	collector-emitter voltage	open base	-	-45	V	
$V_{EBO}$	emitter-base voltage	open collector	-	-5	V	
$I_C$	collector current		-	-100	mA	
$I_{CM}$	peak collector current	single pulse; $t_p \leq 1$ ms	-	-200	mA	
$P_{tot}$	total power dissipation	$T_{amb} \leq 25$ °C				
	SOT666		[1][2]	-	200	mW
	SOT363		[1]	-	200	mW
	SOT457		[1]	-	250	mW
<b>Per device</b>						
$P_{tot}$	total power dissipation	$T_{amb} \leq 25$ °C				
	SOT666		[1][2]	-	300	mW
	SOT363		[1]	-	300	mW
	SOT457		[1]	-	380	mW
$T_j$	junction temperature		-	150	°C	
$T_{amb}$	ambient temperature		-65	+150	°C	
$T_{stg}$	storage temperature		-65	+150	°C	

[1] Device mounted on an FR4 Printed-Circuit Board (PCB), single-sided copper, tin-plated and standard footprint.

[2] Reflow soldering is the only recommended soldering method.

## 6. Thermal characteristics

**Table 7. Thermal characteristics**

Symbol	Parameter	Conditions	Min	Typ	Max	Unit	
<b>Per transistor</b>							
$R_{th(j-a)}$	thermal resistance from junction to ambient	in free air					
	SOT666		[1][2]	-	-	625	K/W
	SOT363		[1]	-	-	625	K/W
	SOT457		[1]	-	-	500	K/W

**Table 7. Thermal characteristics ...continued**

Symbol	Parameter	Conditions	Min	Typ	Max	Unit
<b>Per device</b>						
$R_{th(j-a)}$	thermal resistance from junction to ambient	in free air				
	SOT666		[1][2]	-	416	K/W
	SOT363		[1]	-	416	K/W
	SOT457		[1]	-	328	K/W

[1] Device mounted on an FR4 PCB, single-sided copper, tin-plated and standard footprint.

[2] Reflow soldering is the only recommended soldering method.

## 7. Characteristics

**Table 8. Characteristics**

$T_{amb} = 25\text{ }^{\circ}\text{C}$  unless otherwise specified

Symbol	Parameter	Conditions	Min	Typ	Max	Unit	
<b>Per transistor</b>							
$I_{CBO}$	collector-base cut-off current	$V_{CB} = -30\text{ V};$ $I_E = 0\text{ A}$	-	-	-15	nA	
		$V_{CB} = -30\text{ V};$ $I_E = 0\text{ A};$ $T_j = 150\text{ }^{\circ}\text{C}$	-	-	-5	$\mu\text{A}$	
$I_{EBO}$	emitter-base cut-off current	$V_{EB} = -5\text{ V};$ $I_C = 0\text{ A}$	-	-	-100	nA	
$h_{FE}$	DC current gain	$V_{CE} = -5\text{ V};$ $I_C = -10\text{ }\mu\text{A}$	-	250	-		
		$V_{CE} = -5\text{ V};$ $I_C = -2\text{ mA}$	200	290	450		
$V_{CEsat}$	collector-emitter saturation voltage	$I_C = -10\text{ mA};$ $I_B = -0.5\text{ mA}$	-	-50	-200	mV	
		$I_C = -100\text{ mA};$ $I_B = -5\text{ mA}$	-	-200	-400	mV	
$V_{BEsat}$	base-emitter saturation voltage	$I_C = -10\text{ mA};$ $I_B = -0.5\text{ mA}$	[1]	-	-760	mV	
		$I_C = -100\text{ mA};$ $I_B = -5\text{ mA}$	[1]	-	-920	mV	
$V_{BE}$	base-emitter voltage	$V_{CE} = -5\text{ V};$ $I_C = -2\text{ mA}$	[2]	-600	-650	-700	mV
		$V_{CE} = -5\text{ V};$ $I_C = -10\text{ mA}$	[2]	-	-	-760	mV
$C_c$	collector capacitance	$V_{CB} = -10\text{ V};$ $I_E = i_e = 0\text{ A};$ $f = 1\text{ MHz}$	-	-	2.2	pF	
$C_e$	emitter capacitance	$V_{EB} = -0.5\text{ V};$ $I_C = i_c = 0\text{ A};$ $f = 1\text{ MHz}$	-	10	-	pF	

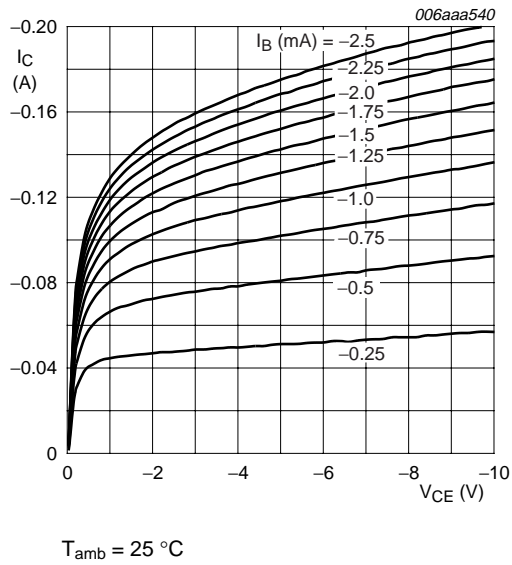
**Table 8. Characteristics ...continued** $T_{amb} = 25^{\circ}\text{C}$  unless otherwise specified

Symbol	Parameter	Conditions	Min	Typ	Max	Unit
$f_T$	transition frequency	$V_{CE} = -5\text{ V};$ $I_C = -10\text{ mA};$ $f = 100\text{ MHz}$	100	175	-	MHz
NF	noise figure	$V_{CE} = -5\text{ V};$ $I_C = -0.2\text{ mA};$ $R_S = 2\text{ k}\Omega;$ $f = 10\text{ Hz to}$ $15.7\text{ kHz}$	-	1.6	-	dB
		$V_{CE} = -5\text{ V};$ $I_C = -0.2\text{ mA};$ $R_S = 2\text{ k}\Omega;$ $f = 1\text{ kHz};$ $B = 200\text{ Hz}$	-	3.1	-	dB
<b>Per device</b>						
$h_{FE1}/h_{FE2}$	$h_{FE}$ matching	$V_{CE} = -5\text{ V};$ $I_C = -2\text{ mA}$	[3] 0.9	1	-	
$V_{BE1}-V_{BE2}$	$V_{BE}$ matching	$V_{CE} = -5\text{ V};$ $I_C = -2\text{ mA}$	[4] -	-	2	mV

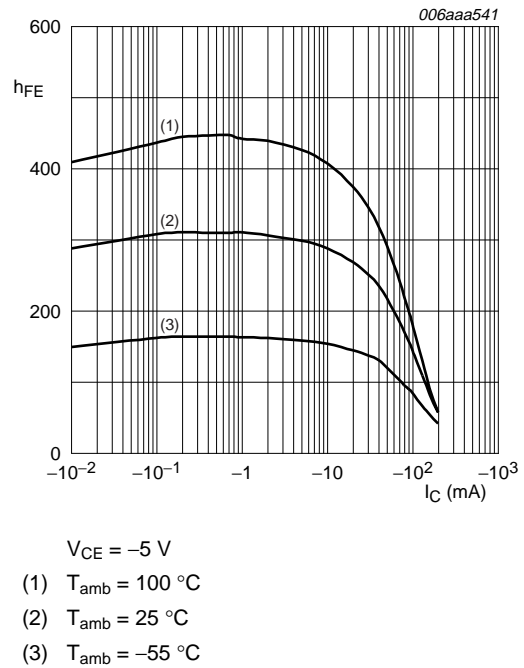
[1]  $V_{BEsat}$  decreases by about 1.7 mV/K with increasing temperature.[2]  $V_{BE}$  decreases by about 2 mV/K with increasing temperature.

[3] The smaller of the two values is taken as the numerator.

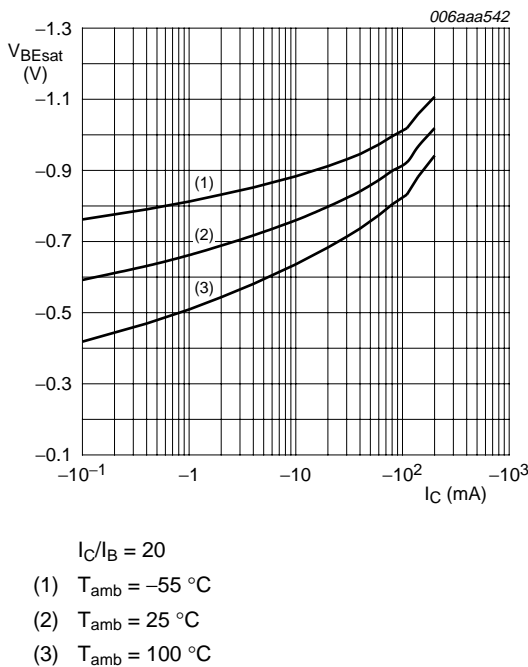
[4] The smaller of the two values is subtracted from the larger value.



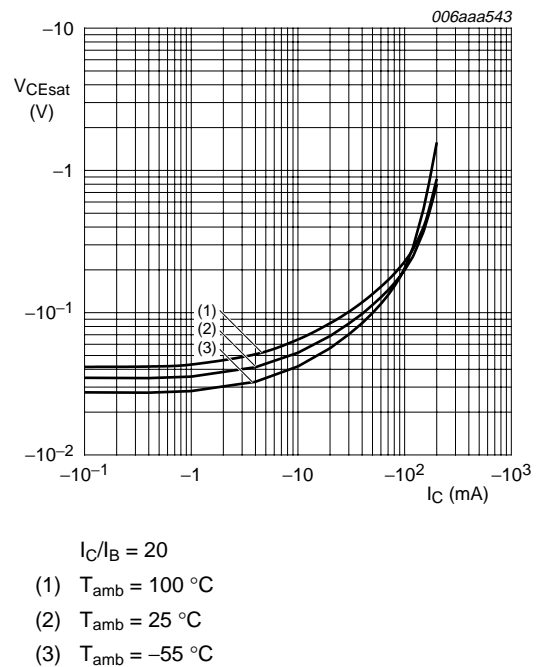
**Fig 1. Collector current as a function of collector-emitter voltage; typical values**



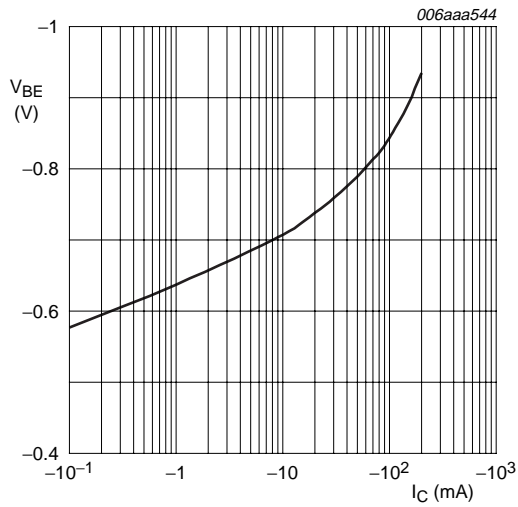
**Fig 2. DC current gain as a function of collector current; typical values**



**Fig 3. Base-emitter saturation voltage as a function of collector current; typical values**

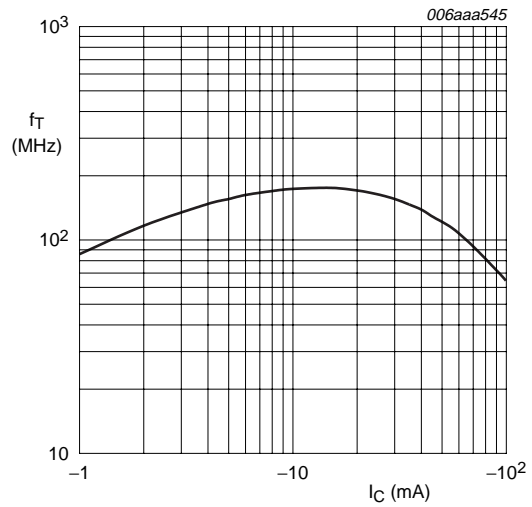


**Fig 4. Collector-emitter saturation voltage as a function of collector current; typical values**



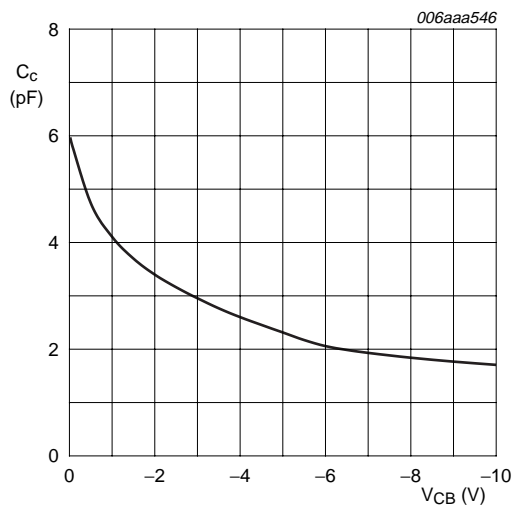
$V_{CE} = -5\text{ V}; T_{amb} = 25\text{ }^\circ\text{C}$

**Fig 5. Base-emitter voltage as a function of collector current; typical values**



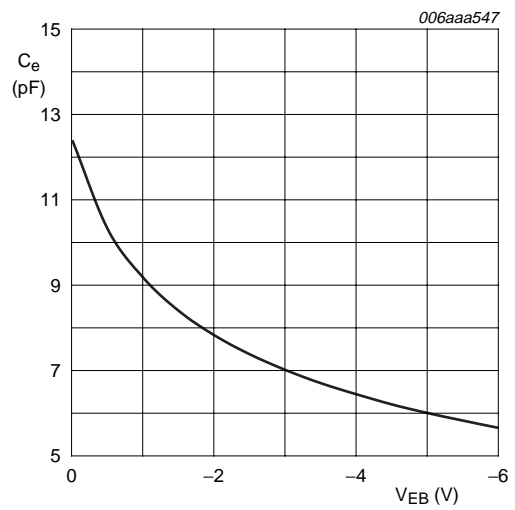
$V_{CE} = -5\text{ V}; T_{amb} = 25\text{ }^\circ\text{C}$

**Fig 6. Transition frequency as a function of collector current; typical values**



$f = 1\text{ MHz}; T_{amb} = 25\text{ }^\circ\text{C}$

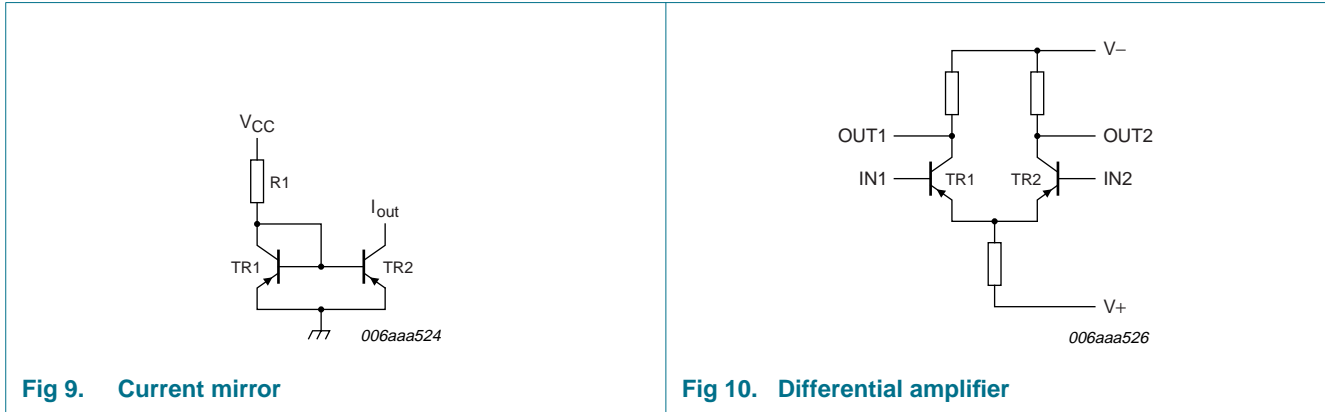
**Fig 7. Collector capacitance as a function of collector-base voltage; typical values**



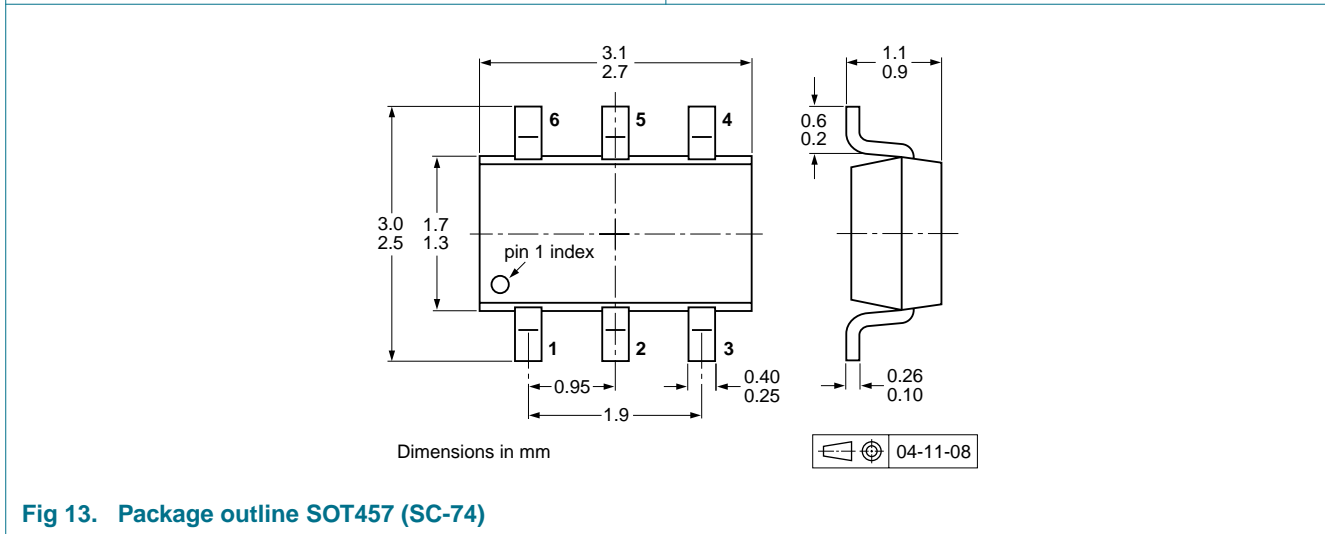
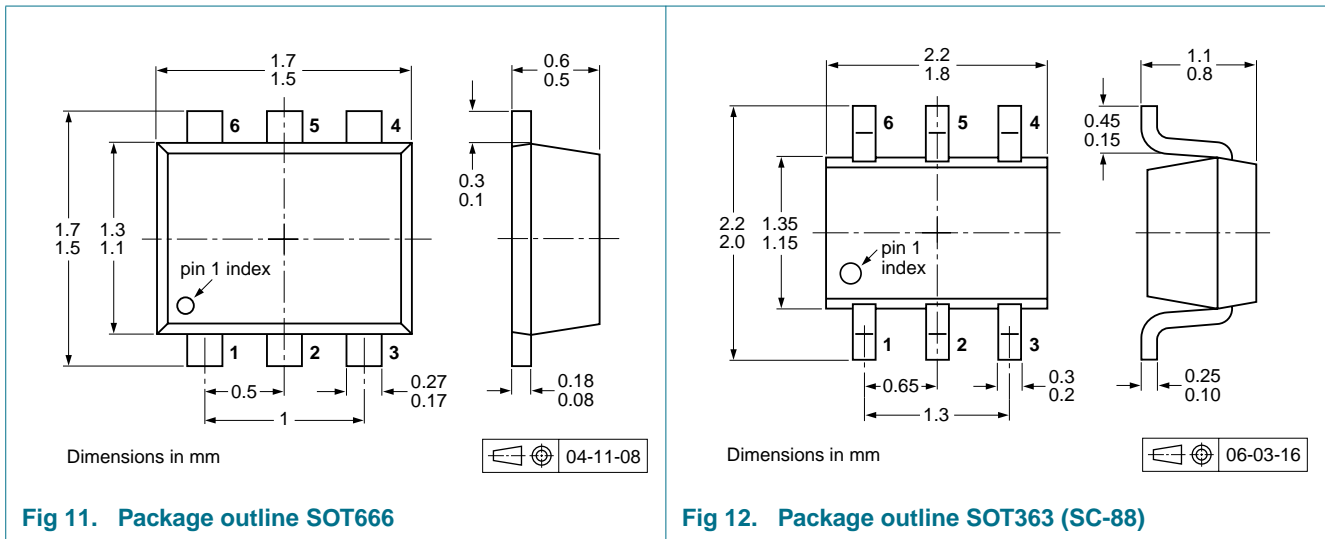
$f = 1\text{ MHz}; T_{amb} = 25\text{ }^\circ\text{C}$

**Fig 8. Emitter capacitance as a function of emitter-base voltage; typical values**

### 8. Application information



### 9. Package outline





## 10. Packing information

**Table 9. Packing methods**

The indicated -xxx are the last three digits of the 12NC ordering code.<sup>[1]</sup>

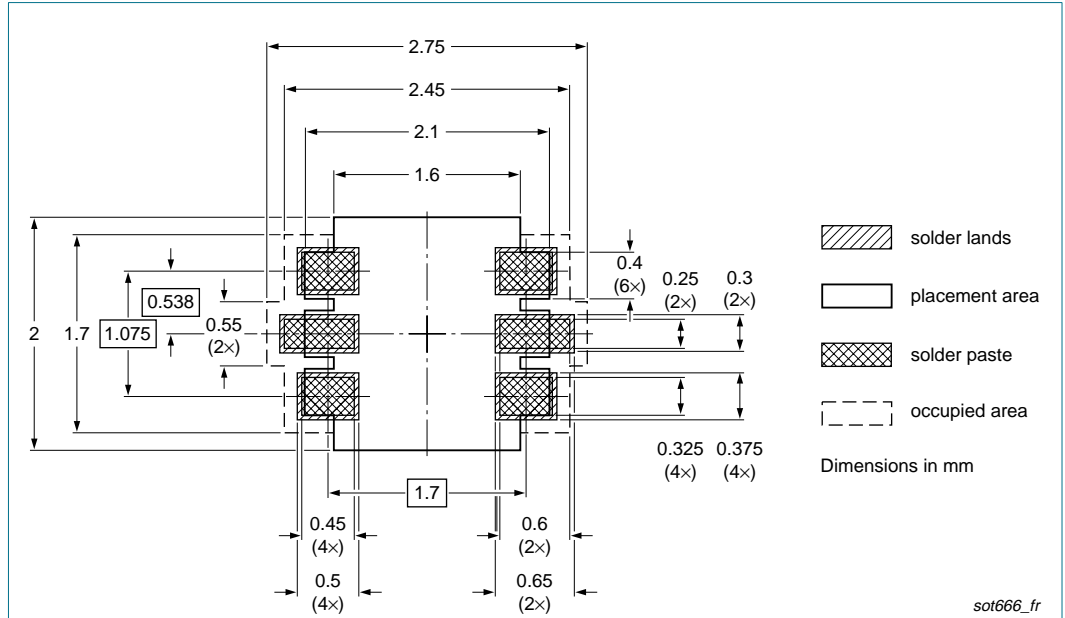
Type number	Package	Description	Packing quantity			
			3000	4000	8000	10000
BCM857BV	SOT666	2 mm pitch, 8 mm tape and reel	-	-	-315	-
		4 mm pitch, 8 mm tape and reel	-	-115	-	-
BCM857BS	SOT363	4 mm pitch, 8 mm tape and reel; T1 <sup>[2]</sup>	-115	-	-	-135
		4 mm pitch, 8 mm tape and reel; T2 <sup>[3]</sup>	-125	-	-	-165
BCM857DS	SOT457	4 mm pitch, 8 mm tape and reel; T1 <sup>[2]</sup>	-115	-	-	-135
		4 mm pitch, 8 mm tape and reel; T2 <sup>[3]</sup>	-125	-	-	-165

[1] For further information and the availability of packing methods, see [Section 14](#).

[2] T1: normal taping

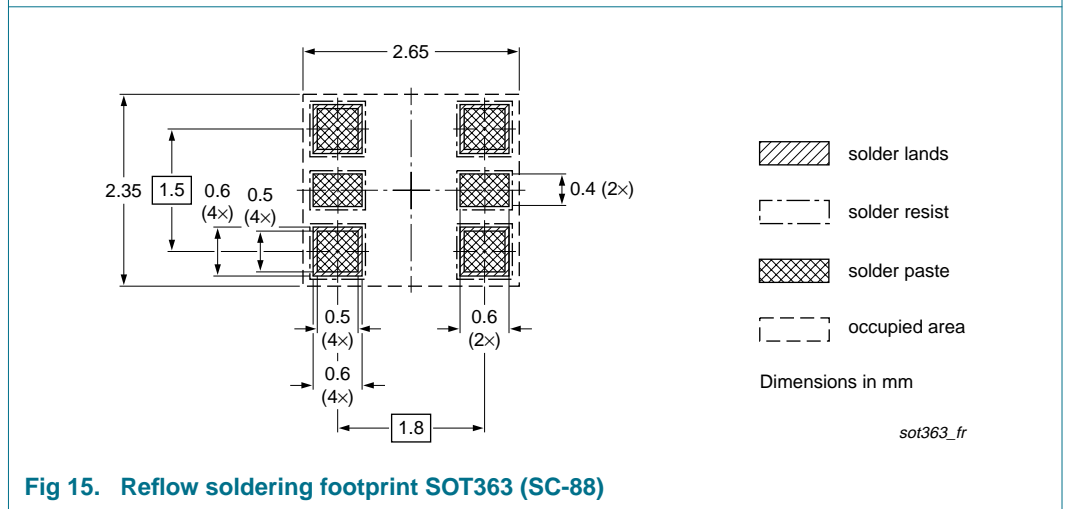
[3] T2: reverse taping

11. Soldering

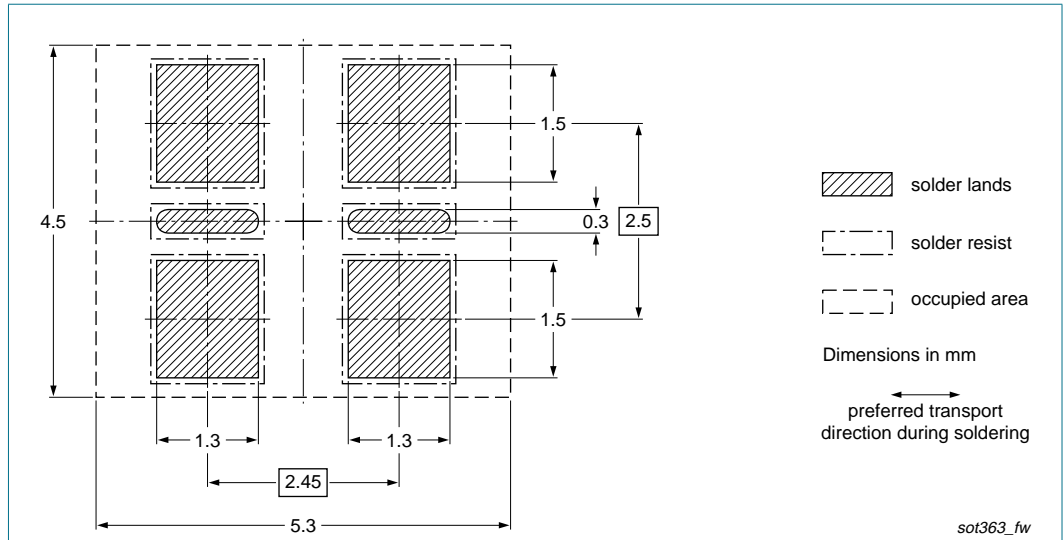


Reflow soldering is the only recommended soldering method.

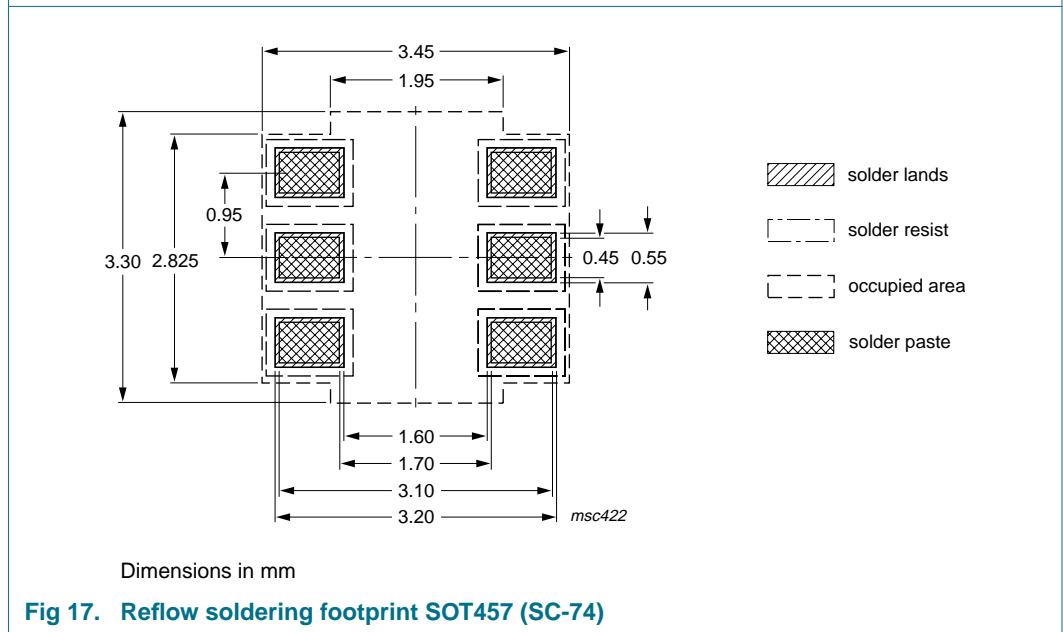
**Fig 14. Reflow soldering footprint SOT666**

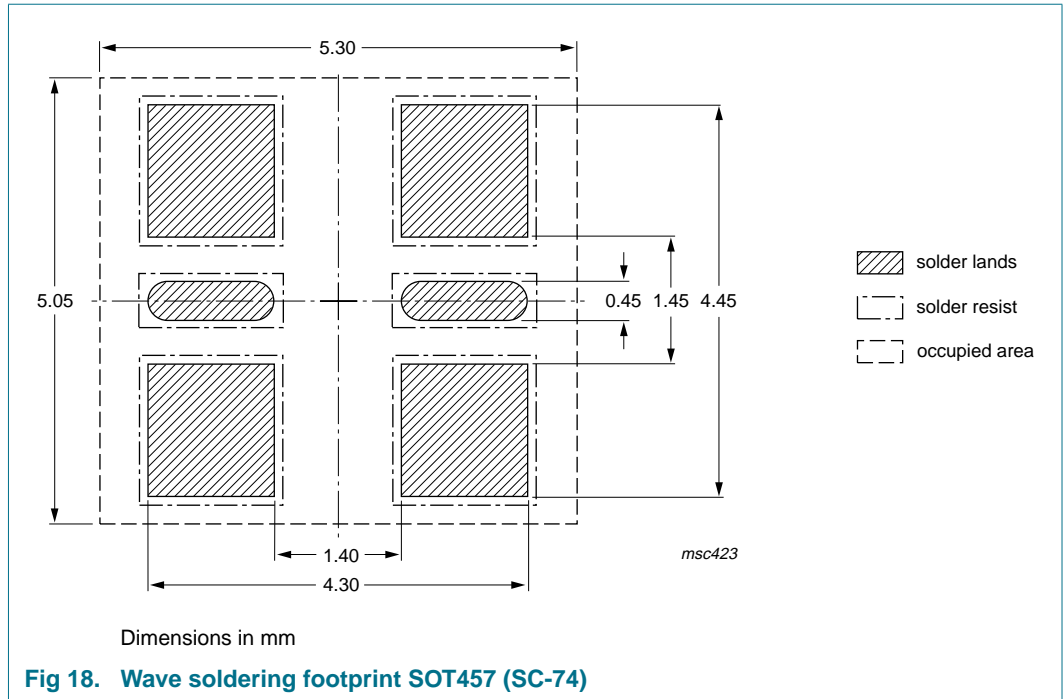


**Fig 15. Reflow soldering footprint SOT363 (SC-88)**



**Fig 16. Wave soldering footprint SOT363 (SC-88)**





## 12. Revision history

**Table 10. Revision history**

Document ID	Release date	Data sheet status	Change notice	Supersedes
BCM857BV_BS_DS_6	20090828	Product data sheet	-	BCM857BV_BS_DS_5
Modifications:		<ul style="list-style-type: none"> <li>This data sheet was changed to reflect the new company name NXP Semiconductors, including new legal definitions and disclaimers. No changes were made to the technical content.</li> <li><a href="#">Figure 12 "Package outline SOT363 (SC-88)":</a> updated</li> <li><a href="#">Figure 14 "Reflow soldering footprint SOT666":</a> updated</li> <li><a href="#">Figure 15 "Reflow soldering footprint SOT363 (SC-88)":</a> updated</li> <li><a href="#">Figure 16 "Wave soldering footprint SOT363 (SC-88)":</a> updated</li> <li><a href="#">Figure 18 "Wave soldering footprint SOT457 (SC-74)":</a> updated</li> </ul>		
BCM857BV_BS_DS_5	20060627	Product data sheet	-	BCM857BS_DS_4
BCM857BS_DS_4	20060216	Product data sheet	-	BCM857BS_DS_3
BCM857BS_DS_3	20060130	Product data sheet	-	BCM857BS_2
BCM857BS_2	20050411	Product data sheet	-	BCM857BS_1
BCM857BS_1	20040914	Product data sheet	-	-

## 13. Legal information

### 13.1 Data sheet status

Document status <sup>[1][2]</sup>	Product status <sup>[3]</sup>	Definition
Objective [short] data sheet	Development	This document contains data from the objective specification for product development.
Preliminary [short] data sheet	Qualification	This document contains data from the preliminary specification.
Product [short] data sheet	Production	This document contains the product specification.

[1] Please consult the most recently issued document before initiating or completing a design.

[2] The term 'short data sheet' is explained in section "Definitions".

[3] The product status of device(s) described in this document may have changed since this document was published and may differ in case of multiple devices. The latest product status information is available on the Internet at URL <http://www.nxp.com>.

### 13.2 Definitions

**Draft** — The document is a draft version only. The content is still under internal review and subject to formal approval, which may result in modifications or additions. NXP Semiconductors does not give any representations or warranties as to the accuracy or completeness of information included herein and shall have no liability for the consequences of use of such information.

**Short data sheet** — A short data sheet is an extract from a full data sheet with the same product type number(s) and title. A short data sheet is intended for quick reference only and should not be relied upon to contain detailed and full information. For detailed and full information see the relevant full data sheet, which is available on request via the local NXP Semiconductors sales office. In case of any inconsistency or conflict with the short data sheet, the full data sheet shall prevail.

### 13.3 Disclaimers

**General** — Information in this document is believed to be accurate and reliable. However, NXP Semiconductors does not give any representations or warranties, expressed or implied, as to the accuracy or completeness of such information and shall have no liability for the consequences of use of such information.

**Right to make changes** — NXP Semiconductors reserves the right to make changes to information published in this document, including without limitation specifications and product descriptions, at any time and without notice. This document supersedes and replaces all information supplied prior to the publication hereof.

**Suitability for use** — NXP Semiconductors products are not designed, authorized or warranted to be suitable for use in medical, military, aircraft, space or life support equipment, nor in applications where failure or malfunction of an NXP Semiconductors product can reasonably be expected to result in personal injury, death or severe property or environmental

damage. NXP Semiconductors accepts no liability for inclusion and/or use of NXP Semiconductors products in such equipment or applications and therefore such inclusion and/or use is at the customer's own risk.

**Applications** — Applications that are described herein for any of these products are for illustrative purposes only. NXP Semiconductors makes no representation or warranty that such applications will be suitable for the specified use without further testing or modification.

**Limiting values** — Stress above one or more limiting values (as defined in the Absolute Maximum Ratings System of IEC 60134) may cause permanent damage to the device. Limiting values are stress ratings only and operation of the device at these or any other conditions above those given in the Characteristics sections of this document is not implied. Exposure to limiting values for extended periods may affect device reliability.

**Terms and conditions of sale** — NXP Semiconductors products are sold subject to the general terms and conditions of commercial sale, as published at <http://www.nxp.com/profile/terms>, including those pertaining to warranty, intellectual property rights infringement and limitation of liability, unless explicitly otherwise agreed to in writing by NXP Semiconductors. In case of any inconsistency or conflict between information in this document and such terms and conditions, the latter will prevail.

**No offer to sell or license** — Nothing in this document may be interpreted or construed as an offer to sell products that is open for acceptance or the grant, conveyance or implication of any license under any copyrights, patents or other industrial or intellectual property rights.

**Export control** — This document as well as the item(s) described herein may be subject to export control regulations. Export might require a prior authorization from national authorities.

**Quick reference data** — The Quick reference data is an extract of the product data given in the Limiting values and Characteristics sections of this document, and as such is not complete, exhaustive or legally binding.

### 13.4 Trademarks

Notice: All referenced brands, product names, service names and trademarks are the property of their respective owners.

## 14. Contact information

For more information, please visit: <http://www.nxp.com>

For sales office addresses, please send an email to: [salesaddresses@nxp.com](mailto:salesaddresses@nxp.com)

## 15. Contents

<b>1</b>	<b>Product profile</b> .....	<b>1</b>
1.1	General description .....	1
1.2	Features .....	1
1.3	Applications .....	1
1.4	Quick reference data .....	1
<b>2</b>	<b>Pinning information</b> .....	<b>2</b>
<b>3</b>	<b>Ordering information</b> .....	<b>2</b>
<b>4</b>	<b>Marking</b> .....	<b>2</b>
<b>5</b>	<b>Limiting values</b> .....	<b>3</b>
<b>6</b>	<b>Thermal characteristics</b> .....	<b>3</b>
<b>7</b>	<b>Characteristics</b> .....	<b>4</b>
<b>8</b>	<b>Application information</b> .....	<b>8</b>
<b>9</b>	<b>Package outline</b> .....	<b>8</b>
<b>10</b>	<b>Packing information</b> .....	<b>9</b>
<b>11</b>	<b>Soldering</b> .....	<b>10</b>
<b>12</b>	<b>Revision history</b> .....	<b>13</b>
<b>13</b>	<b>Legal information</b> .....	<b>14</b>
13.1	Data sheet status .....	14
13.2	Definitions .....	14
13.3	Disclaimers .....	14
13.4	Trademarks .....	14
<b>14</b>	<b>Contact information</b> .....	<b>14</b>
<b>15</b>	<b>Contents</b> .....	<b>15</b>



Please be aware that important notices concerning this document and the product(s) described herein, have been included in section 'Legal information'.

© NXP B.V. 2009. **All rights reserved.**  
 For more information, please visit: <http://www.nxp.com>  
 For sales office addresses, please send an email to: [salesaddresses@nxp.com](mailto:salesaddresses@nxp.com)  
 Date of release: 28 August 2009  
 Document identifier: BCM857BV\_BS\_DS\_6