

Contactors, Overload Relays System Overview

Contactors
Overload Relays

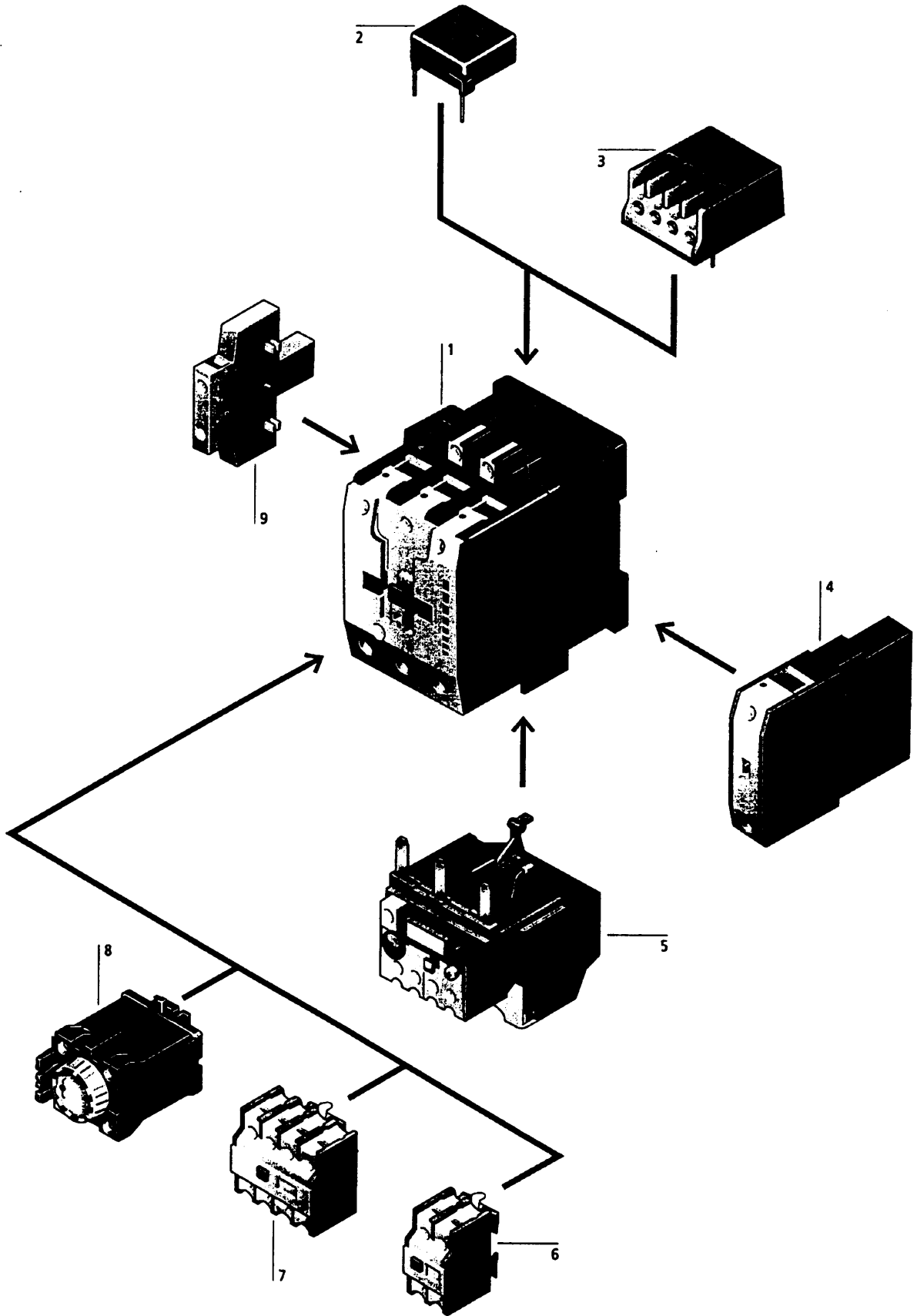

Z and ZW Overload Relays Technical Data

Tripping characteristics

These tripping characteristics show mean values of the tolerance range at 20 °C ambient temperature starting from cold. They show the tripping times in relation to the response current. At operational tem-

perature the tripping time of the overload relay drops to approximately 25% of that shown. Specific characteristics for each individual setting range are available on request. These characteristics for ZE, Z 00, Z 1 and

Z 5 in 55 × 75 format, self-adhesive, correspond to the data in the PTB test report and are used both for the correct selection of overload relays for EEx e motors and for documentation at the point of installation.

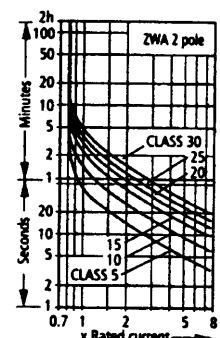
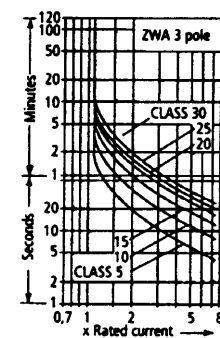
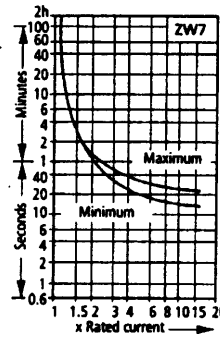
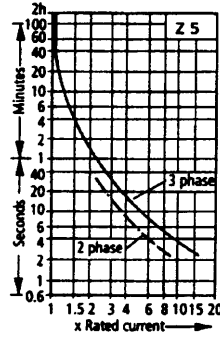
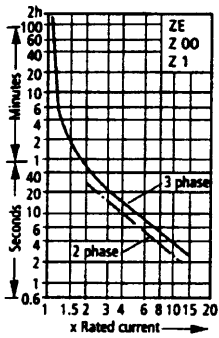

ZE Setting range A	Tripping characteristics to AWA No.
0.1 – 0.16	23-1036-1
0.16 – 0.24	23-1036-2
0.24 – 0.4	23-1036-3
0.4 – 0.6	23-1036-4
0.6 – 1.0	23-1036-5
1.0 – 1.6	23-1036-6
1.6 – 2.4	23-1036-7
2.4 – 4	23-1036-8
4 – 6	23-1036-9
6 – 9	23-1036-10

Z 00 Setting range A	Tripping characteristics to AWA No.
0.1 – 0.16	23-657-10
0.16 – 0.24	23-657-12
0.24 – 0.4	23-657-14
0.4 – 0.6	23-657-16
0.6 – 1.0	23-657-18
1.0 – 1.6	23-657-20
1.6 – 2.4	23-657-22
2.4 – 4	23-657-24
4 – 6	23-657-26
6 – 10	23-657-28
10 – 16	23-657-30
16 – 24	23-657-32

Z 1 Setting range A	Tripping characteristics to AWA No.
6 – 10	23-657-40
10 – 16	23-657-42
16 – 24	23-657-44
24 – 40	23-657-46
40 – 57	23-657-48
50 – 63	23-657-49
63 – 75	23-657-51.2

ZW 7 Setting range A	Tripping characteristics to AWA No.
42 – 63	23-657-60
60 – 90	23-657-62
85 – 125	23-657-64
100 – 160	23-657-66
160 – 240	23-657-68
190 – 290	23-657-70
270 – 400	23-657-72
360 – 540	23-657-74
420 – 630	23-657-76

Z 5.../J.K. Setting range A	Tripping characteristics to AWA No.
25 – 30	23-657-80
35 – 50	23-657-82
50 – 70	23-657-84
70 – 100	23-657-86
95 – 125	23-657-88
120 – 160	23-657-90

Z 5.../FF6 Setting range A	Tripping characteristics to AWA No.
50 – 70	23-657-92
70 – 100	23-657-94
95 – 125	23-657-96
120 – 160	23-657-98
160 – 220	23-657-100

ZWA Load	Tripping characteristics to AWA No.
2-pole	23-657-110
3-pole	23-657-120

Features

	ZE	Z 00 Z 1	Z 5	ZW 7
Phase-failure sensitivity	●	●	●	-
Temperature compensation	●	●	●	●
Auxiliary contacts 1 M + 1 B	●	●	●	●
Test-/Off button	●	●	●	●
Reset button Hand/Auto	●	●	●	●
Separate mounting	-	●	●	●
Protection of EEx e motors (PTB)	●	●	●	-
Protection during heavy starting duty	-	-	-	●
Trip-free release	●	●	●	●
Trip indication	-	●	●	●

● Standard feature

Protection of DC motors:

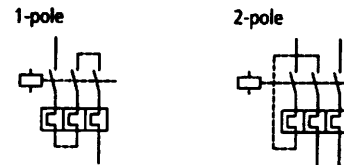

Mounting position:

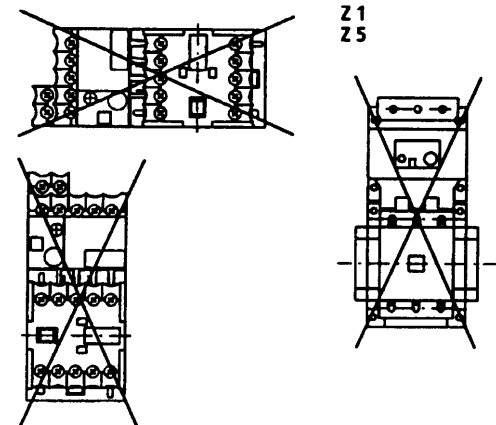

Z Overload Relays

Technical Data

		ZE	Z 00	Z 1 (Z 1-75)	Z 5-/K3	Z 5-/K4
General						
Standards		IEC/EN 60 947, VDE 0660, UL, CSA, shipping classifications → Page 17/055				
Climatic proofing		Damp heat, constant, to IEC 60 068-2-3 Damp heat, cyclic, to IEC 60 068-2-30				
Ambient temperature	Open	Min./Max. °C	-25/+50 ¹⁾	-25/+50 ¹⁾	-25/+50 ¹⁾	-25/+50 ¹⁾
	Enclosed		-25/+40 ¹⁾	-25/+40 ¹⁾	-25/+40 ¹⁾	-25/+40 ¹⁾
Temperature compensation			Continuous			
Dimensions	Page		06/117	06/117	06/117	06/117
Mounting position	Page		06/083	06/083	06/083	06/083
Weights		kg	0.07	0.13	0.21	1.3 (/JK3)
		kg	-	-	(0.34)	1.44 (/KK3)
		kg	-	-	(0.34)	1.64 (/KK4)
Mechanical shock resistance (sinusoidal shock)	g/ms		10/10	10/10	10/10	10/10
Degree of protection			IP20	IP00	IP00	IP00
Protection against direct contact from front when actuated by a perpendicular test finger (IEC 536)			Finger- and back-of-hand proof			
Main contacts						
Rated impulse withstand voltage U_{imp}	V		6000	6000	6000	8000
Overvoltage category/pollution degree			III/3	III/3	III/3	III/3
Rated isolation voltage U_i	V AC		690	690	690	1000
Rated operational voltage U_e	V AC		690	690	690	1000
"Safe isolation" to IEC 536						
between main contacts and auxiliary contacts and between main contacts	V AC		300	440	440	440
Current setting	A		0.1 – 9	0.1 – 24	6 – 75	25 – 100
Short-circuit protection						
Max. fuse	Page		06/072	06/072	06/074	06/074
Fuseless, response values	Page				06/074	06/074
Heat losses (in 3 current paths)						
Minimum setting	W		2.5	2.5	3 (7)	< 16
Maximum setting	W		6	6	7.5 (10)	< 28
Terminal capacity						
Solid	mm ²		2 × (0.75 – 2.5)	2 × (1 – 6)	2 × (1 – 16) ³⁾	16
Flexible without ferrule	mm ²		-	-	-	50
Flexible with ferrule	mm ²		2 × (0.5 – 1.5)	2 × (1 – 6)	1 × 25 2 × (1 – 10) ³⁾	70
Stranded	mm ²		-	-	-	50
Flexible with cable lug	mm ²		-	-	-	-
Stranded with cable lug	mm ²		-	-	-	-
Solid or stranded	AWG		18 – 14	14 – 8	14 – 2	2
Flat conductor ⁴⁾	mm		-	-	-	6 × 9 × 0.8
Busbar	mm		-	-	-	6 × 16 × 0.8
Terminal screws			M3.5	M4	M6	M8
Pozi driv screwdriver	Size		2	2	2	-
Standard screwdriver	mm		0.8 × 5.5	1 × 6	1 × 6	-
SW hexagon socket head screw	mm		-	-	-	4
SW hexagon-head screw	mm		-	-	-	5
Tightening torque	Nm		1.2	1.8	3.5	6

Notes

- ¹⁾ Operating range to IEC/EN 60 947, PTB: -5 °C to +50 °C
²⁾ With pollution degree 2

- ³⁾ When using two conductors, use equal cross-sections

- ⁴⁾ Z5-/FF6: Secure using box terminals
 → Page 06/036

Z Overload Relays

Dimensions

Overload relays

ZE

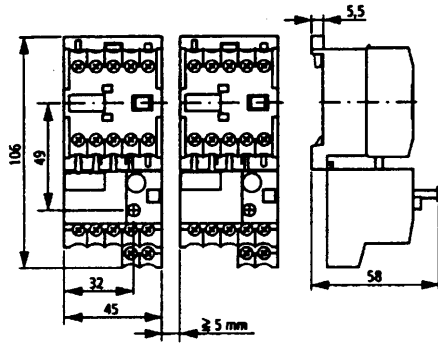

Z00 + EZ 00
Z1 + EZ 1

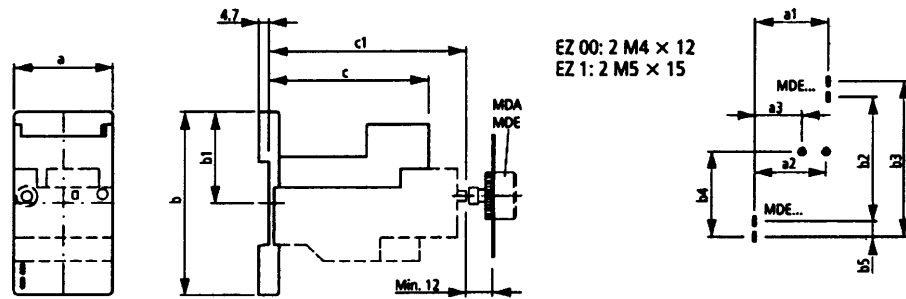

	EZ 00	EZ 1
a	45	60
a1	35	50
a2	34	41.5
a3	22.5	30
b	85	86
b1	42.5	42.5
b2	60	-
b3	75	75
b4	41	36
b5	7.5	-
c	73	112
c1	90	102

Z5-.../SK

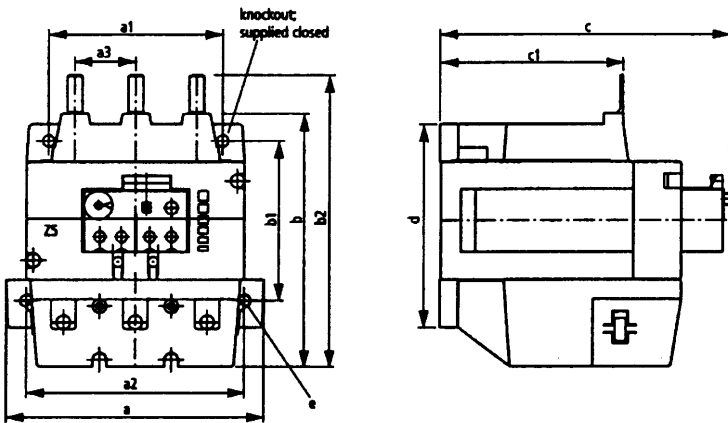

	Z 5-.../SK 3	Z 5-.../SK 4
a	100	118
a1	80	80
a2	80	100
a3	28	28
b	117	117
b1	74	74
b2	135	135
c	133	133
c1	82,5	84
d	94	94
e	Ø6	Ø7

Z5-.../KK

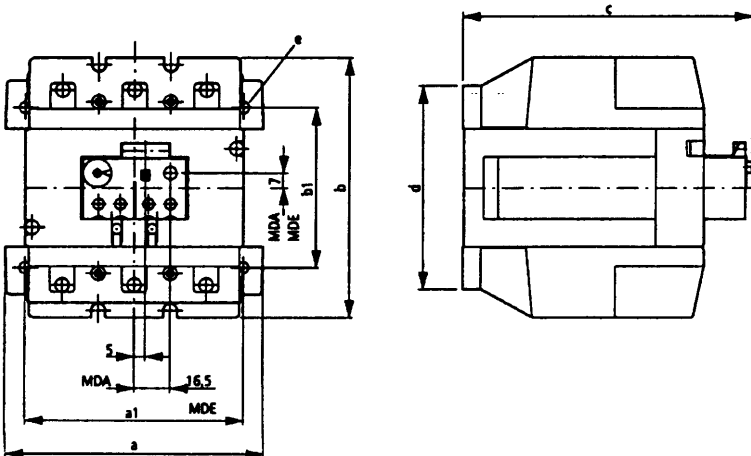



	Z 5-.../KK 3	Z 5-.../KK 4
a	100	118
a1	80	100
b	120	120
b1	74	74
c	133	133
d	94	94
e	Ø6	Ø7

Overload Relays

ZE, Z00 Overload Relays

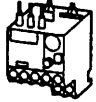
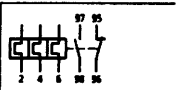
Contactor and Overload Relays

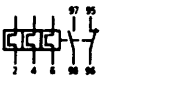
Setting range of overload release	Circuit diagram	Auxiliary contacts		For use with	Short-circuit protection	
		Make contact	Break contact		Type of coordination "1"	Type of coordination "2"
I_r A					Max. A gL	Max. A gL
ZE overload relay						
For direct mounting						
		1 M	1 B	DIL E(E)M, DIUL E(E)M/21/MV, SDAINL EM, MSE	20	0.5
0.1 - 0.16					20	1
0.16 - 0.24					20	2
0.24 - 0.4					20	2
0.4 - 0.6					20	4
0.6 - 1					20	6
1 - 1.6					20	6
1.6 - 2.4					20	10
2.4 - 4					20	10
4 - 6					20	10
6 - 9						
Z 00 overload relay						
For direct mounting						
		1 M	1 B	DIL 00 (A)M, DIL 0 (A)M DIUL 00 (A)M/11, DIUL 0 (A)M/11, SDAINL 00 AM, SDAINL 0 (A)M	25	0.5
0.1 - 0.16					25	1
0.16 - 0.24					25	2
0.24 - 0.4					25	4
0.4 - 0.6					25	4
0.6 - 1					25	6
1 - 1.6					25	10
1.6 - 2.4					25	16
2.4 - 4					25	20
4 - 6					50	25
6 - 10	63	35				
10 - 16	63	50				
16 - 24						

Overload Relays

ZE, Z00 Overload Relays

Type	Price	Std.
Article no.	See Price List	pack
ZE-0,16 014263		5 off
ZE-0,24 014285		
ZE-0,4 014300		
ZE-0,6 014333		
ZE-1,0 014376		
ZE-1,6 014432		
ZE-2,4 014479		
ZE-4 014518		
ZE-6 014565		
ZE-9 014708		

Z 00-0,16 048313		3 off
Z 00-0,24 050686		
Z 00-0,4 053059		
Z 00-0,6 055432		
Z 00-1,0 057805		
Z 00-1,6 060178		
Z 00-2,4 062551		
Z 00-4 064924		
Z 00-6 067297		
Z 00-10 069670		
Z 00-16 072043		
Z 00-24 074416		

Notes

Overload release: tripping class 10 A

When using DIL E(E)M and ZE:
a distance of at least 5 mm should be maintained between
overload relays which are mounted side by side.

Short-circuit protection:
The maximum admissible fuse for the contactor must be
observed when mounting overload relays directly.

ZE, Z 00:
Fitted directly to the contactor

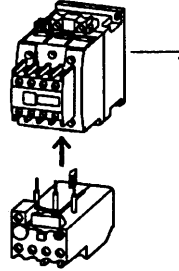

Z 00:
Separate mounting

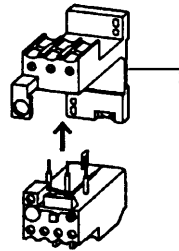

Accessories	Page
1 Contactors	06/006
2 Bases	06/082
Accessories	06/082

Suitable for the protection of EEx e motors.
PTB certificate No.
ZE: 3.53/38 0.793
Z 00: 3.53 - 12759/96

Single-phasing sensitivity to
IEC/EN 60 947-4-1

Z 00 and EZ 00 can be used with DIL SM... semiconductor
contactors

For selection see Page 06/016

Contactor Overload Relay