

8-bit Proprietary Microcontroller

CMOS

F²MC-8L MB89550A Series

MB89557A/558A/P558A/PV550A

■ DESCRIPTION

The MB89550A series is a general-purpose, single-chip microcontroller that features a compact instruction set and contains a range of peripheral functions including a dual-clock control system, 5-level operating speed control, LCD controller driver, A/D converter, D/A converter, timer, serial interface, PWM timer, PWC timer, and external interrupts. The LCD controller driver is particularly suited for simultaneous control of LCD duty drive and static drive functions.

■ FEATURES

- **Range of package options**
 - LQFP package (0.5 mm pitch)
 - TQFP package (0.4 mm pitch)
- **High speed operation at low voltage**
 - Minimum instruction execution time 0.32 μ s (for 12.5 MHz oscillation)
- **F²MCR-8L CPU core**
 - Instruction set optimized for controller applications
 - Multiplication and division instructions
 - 16-bit arithmetic operations
 - Bit test branch instructions
 - Bit manipulation instructions, etc.

(Continued)

■ PACKAGE

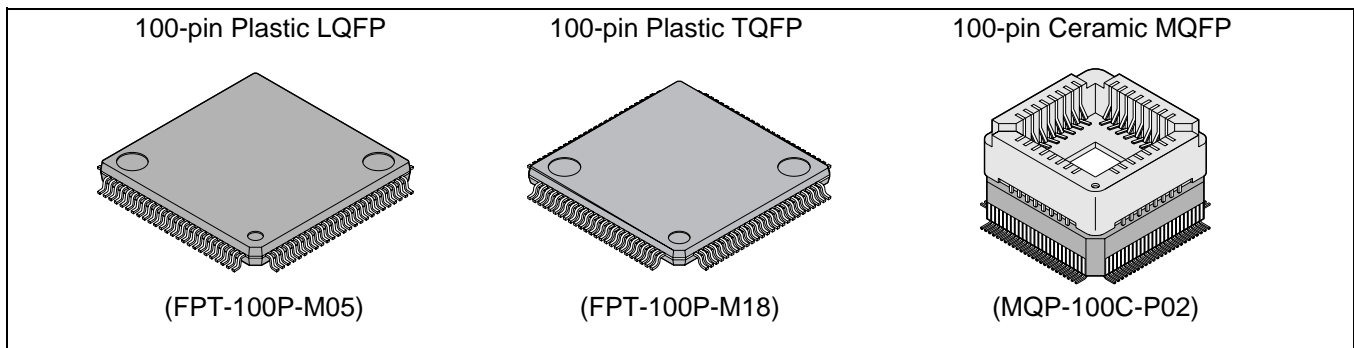

MB89550A Series

(Continued)

- **Dual-clock control system**
 - Main clock 12.5 MHz maximum : (Four speed settings available, oscillation halts in sub-clock mode)
 - Sub-clock 32.768 kHz : (Operation clock for sub-clock mode)
- **11 timer systems**
 - 8/16-bit timer counter 1 (square wave output, 2-channel output switching available)
 - 8/16-bit timer counter 2 (square wave output, 2-channel output switching available)
 - 16-bit timer counter (also functions as event counter)
 - 8-bit PWM timer (8-bit PWM timer × 2 channels or PPG timer × 1 channel, includes event counter function)
 - 8-bit PWC timer (8-bit PWC timer × 1 channel)
 - 6-bit PPG timer (6-bit PPG timer × 1 channel)
 - 21-bit timebase timer
 - Clock prescaler (17-bit)
- **UART/serial interface**
 - UART/SIO switching
- **UART**
 - Clock synchronous/asynchronous switching available
- **10-bit A/D converter**
 - 10-bit A/D × 8 channels
- **8-bit D/A converter**
 - 8-bit D/A × 2 channels
- **External interrupts**
 - Eight independent inputs can be used for recovery from low-power consumption modes (selection of rising, falling, or both edge detection functions).
 - Eight independent inputs can be used for recovery from low-power consumption modes (L level detection function included).
- **Clock output functions**
 - High speed clock signal multiplied by 2 available as output from HCLK pin.
 - Low speed clock pulse output available from LCLK pin.
- **LCD controller driver**
 - 32SEG × 4COM (maximum 128 pixels)
 - 8 dedicated to segment output only
 - 8 for port or segment use
 - 16 for port, segment, or static use
 - Built-in step-up power supply for driving LCD (optionally available)
- **Low-power consumption modes (standby modes)**
 - Stop mode (all oscillations halt in sub-clock mode, current consumption falls to almost zero)
 - Sleep mode (the CPU stops to reduce current consumption to approximately 1/3 of normal)
 - Clock mode (all operations other than the clock prescaler halt, current consumption is very low)
 - Sub clock mode (systems operate on sub-clock signals)
- **Maximum 66 I/O ports**
 - General-purpose I/O ports (N-ch open drain) : 4
 - General-purpose I/O ports (N-ch open drain) : 24
 - [also function as LCD ports, with restrictions]
 - General purpose I/O ports (CMOS) : 38

MB89550A Series

■ PRODUCT LINEUP

Part no.	MB89P558A-201 MB89P558A-202 MB89P558A-203	MB89557A	MB89558A	MB89PV550A*-201 MB89PV550A*-202 MB89PV550A*-203
ROM size	48 KB	32 KB	48 KB	—
RAM size	2 KB	1 KB	2 KB	1 KB
Packages	LQFP100 TQFP100	LQFP100 TQFP100	LQFP100 TQFP100	LQFP100
Classification	One-time product	Mask ROM product	Mask ROM product	Evaluation product
CPU functions	Number of instructions : 136 Instruction bit length : 8-bit Instruction length : 1 to 3bytes Data bit length : 1-, 8-, 16-bits Minimum execution time : 0.32 μs (at 12.5 MHz) Interrupt processing time : 2.88 μs (at 12.5 MHz)			
Peripheral Functions	Ports	Output-only ports (N-ch open drain) General-purpose I/O ports (N-ch open drain) General-purpose I/O ports (CMOS)		
	8/16-bit timer counter 1	2-channel 8-bit timer/counter operation (also functions as 1-channel 16-bit timer) with square wave output function		
	8/16-bit timer counter 2	2-channel 8-bit timer/counter operation (also functions as 1-channel 16-bit timer) with square wave output function		
	16-bit timer counter	16-bit timer/counter operation, 16-bit event counter operation		
	PPWM timer	2-channel 8-bit PWM timer operation (also functions as 1-channel PPG timer) with event counter function		
	PWC timer	1-channel 8-bit PWC timer operation		
	6-bit PPG timer	1-channel 6-bit PWM timer operation		
	LCD controller driver	Maximum 32SEG \bar{A} ~4COM (some ports provide selection of DUTY drive/STATIC drive/N-ch open drain I/O port functions)		
	UART	SIO	Switchable between UART (with clock synchronous/asynchronous data transfer function) and SIO (simple serial)	
	UART/SIO		Data transfer function for UART/SIO	
	A/D converter	8-channel 10-bit resolution		
	D/A converter	2-channel, 8-bit resolution		
	Clock output	High speed clock multiplied $\times 2$, and sub clock output available		
Standby modes	Sub clock mode, sleep mode, clock mode, and stop mode			

* : The MB89PV550A provides only evaluation functions (functions for use with emulation tools). This model cannot use piggyback functions (functions for use with E²PROM).

MB89550A Series

■ OPTIONS AND CORRESPONDING PRODUCTS

		-201 Options	-202 Options	-203 Options
LCD step-up circuit		No step-up circuit	Step-up circuit included	
PORT/SEG dual-use pin selection		SEG8 to SEG31 : SEG/PORT dual use	SEG8 to SEG31 : SEG/PORT dual use	SEG8 to SEG21 : SEG/PORT dual use SEG22 to SEG31 : N-ch open drain*1
Model type	Evaluation model	MB89PV550A-201	MB89PV550A-202	MB89PV550A-203
	One-time model	MB89P558A-201	MB89P558A-202	MB89P558A-203
	Mask ROM model*2	MB89557A	MB89557A	MB89557A
		MB89558A	MB89558A	MB89558A

*1 : The SEG22-SEG31 pins (N-ch open drain) are not subject to the restriction that input voltage (V_{IN}) must be less than the voltage at the V3 pin.

*2 : Options may be specified at the time of mask ROM ordering.

■ OSCILLATOR STABILIZATION WAIT TIME SELECTION

The MB89557A/558A allow a selection of default value for oscillator stabilization wait time, to be selected at the time of mask ROM ordering.

Oscillator stabilization wait time selection	Remarks
$2^{14}/F_{CH}$	1.31 ms (at F = 12.5 MHz)
$2^{17}/F_{CH}$	10.48 ms (at F = 12.5 MHz)
$2^{18}/F_{CH}$	20.97 ms (at F = 12.5 MHz)

■ DIFFERENCES AMONG PRODUCTS AND PRECAUTIONS FOR MODEL SELECTION

• Package and Model Combinations

Package \ Models	MB89PV550A	MB89P558A	MB89557A MB89558A
FPT-100P-M05 (LQFP-100 0.5 mm pitch)	×	○	○
FPT-100P-M18 (TQFP-100 0.4 mm pitch)	×	○	○
MQP-100C-P02 (MQFP-100 0.5 mm pitch)	○	×	×

Note : Compatible with all options (-201/202/203) .

• Memory Space

- When evaluating chips using piggyback evaluators etc., please take note of the differences among products before making the evaluation.

• Current Consumption

- When operating at low speed, one-time PROM and EPROM products will consume more current than mask ROM products. However, the current consumption in sleep/stop modes is the same.
- For specific details about each package, see "■ PACKAGE DIMENSIONS".
- For details about power consumption, see "■ ELECTRICAL CHARACTERISTICS" .

• Mask Options

- The available options, and methods of using options, differ according to the model. Be sure to confirm the options from the "■ MASK OPTIONS" section.

• LCD Drive Step-up Power Circuit

The MB89550A series is available with or without the step-up circuit option as a mask option.

• Power Supply Path

The models in the MB89550A series have two power supply pins, V_{CC1} and V_{CC2} , with power supply paths that differ according to the model.

Models	Supply pin	Power supply path
MB89557A/ 558A	V_{CC1}	3V power supply pin for internal resource operation, including the CPU.
	V_{CC2}	5V power supply pin for input/output ports.
MB89P558A	V_{CC1}	V_{PP} pin for on-board writing.
	V_{CC2}	V power supply pin for internal resource operation, including the CPU, and for input/output pins.
MB89PV550A	V_{CC1}	Internally shut off, operates as input to V_{CC2} only.
	V_{CC2}	5V power supply pin for internal resource operation, including the CPU, and for input/output pins.

• Oscillator Startup and Power-on Reset

On the MB89PV550A and MB89P558A, oscillator startup and power-on reset are applied at the rise of the V_{CC2} input. On the MB89558A and MB89557A, oscillator startup and power-on reset are applied at the rise of the V_{CC1} input.

MB89550A Series

- Wide Register Functions

The space available for use of wide register functions is as follows.

MB89PV550A	2000 _H to FFFF _H
MB89P558A	4000 _H to FFFF _H
MB89558A	4000 _H to FFFF _H
MB89557A	8000 _H to FFFF _H

- The P40, P41, P84, P85 Pins

On the MB889PV550A, an external oscillator signal equivalent to 64 clock pulses is required to initialize the P40, P41, P84, and P85 pins. Note therefore that at power-on there is an interval in which the values of these ports is undefined.

On the MB89P558A, MB89558A, and MB89557A, these ports are set to "Hi-Z" status at power-on.

PIN ASSIGNMENTS

(TOP VIEW)

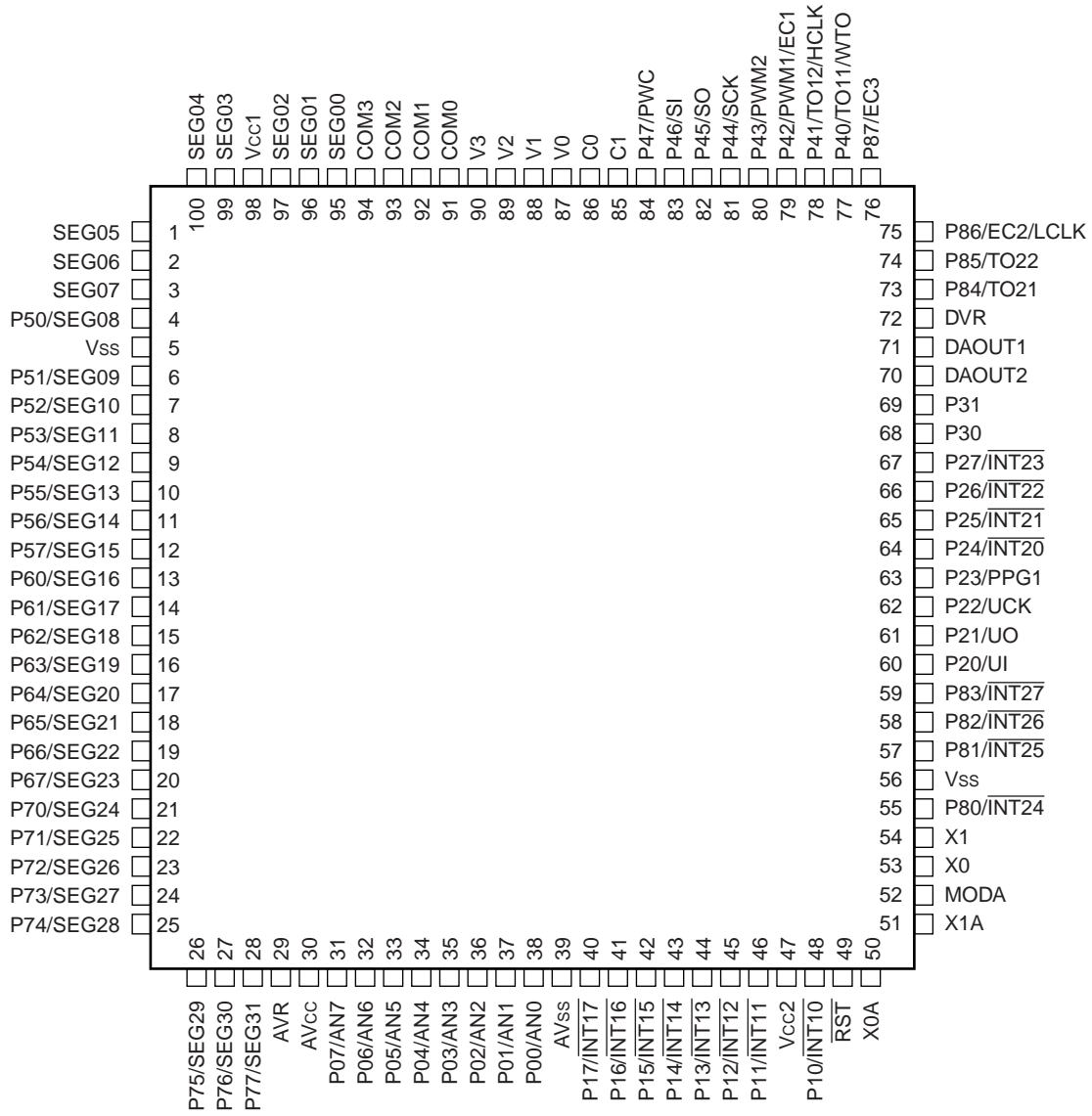

(QFP-100)

MB89550A Series

■ PIN DESCRIPTION

Pin No.	Pin Name	Circuit Type	Function
1	SEG05	H	Segment output pins for LCDC duty drive.
2	SEG06	H	
3	SEG07	H	
4	P50/ SEG08	G	N-ch open drain I/O pin. Also functions as a segment output pin for LCDC duty drive.
5	V _{SS}	—	Power supply (GND) pin.
6	P51/ SEG09	G	N-ch open drain I/O pins. Also function as segment output pins for LCDC duty drive.
7	P52/ SEG10		
8	P53/ SEG11		
9	P54/ SEG12		
10	P55/ SEG13		
11	P56/ SEG14		
12	P57/ SEG15	G	N-ch open drain I/O pins. Also function as segment output pins for LCDC duty drive or static drive.
13	P60/ SEG16		
14	P61/ SEG17		
15	P62/ SEG18		
16	P63/ SEG19		
17	P64/ SEG20		
18	P65/ SEG21		
19	P66/ SEG22		
20	P67/ SEG23		
21	P70/ SEG24		
22	P71/ SEG25		

(Continued)

MB89550A Series

Pin No.	Pin Name	Circuit Type	Function
23	P72/ SEG26	G	N-ch open drain I/O pins. Also function as segment output pins for LCDC duty drive or static drive.
24	P73/ SEG27		
25	P74/ SEG28		
26	P75/ SEG29		
27	P76/ SEG30		
28	P77/ SEG31		
29	AVR	—	A/D converter reference voltage input pin.
30	AV _{cc}	—	A/D converter and D/A converter power supply pin.
31	P07/AN7	D	General purpose I/O ports. Also function as analog input pins.
32	P06/AN6		
33	P05/AN5		
34	P04/AN4		
35	P03/AN3		
36	P02/AN2		
37	P01/AN1		
38	P00/AN0		
39	AV _{ss}	—	A/D converter and D/A converter power supply pin (GND).
40	P17/ $\overline{\text{INT17}}$	E	General purpose I/O ports. Also function as external interrupt 1 input pins. External interrupt 1 input signals are hysteresis signals (edge detection).
41	P16/ $\overline{\text{INT16}}$		
42	P15/ $\overline{\text{INT15}}$		
43	P14/ $\overline{\text{INT14}}$		
44	P13/ $\overline{\text{INT13}}$		
45	P12/ $\overline{\text{INT12}}$		
46	P11/ $\overline{\text{INT11}}$		
47	V _{cc2}	—	Power supply (5V) pin.
48	P10/ $\overline{\text{INT10}}$	E	General purpose I/O port. Also functions as an external interrupt 1 input pin. External interrupt 1 input signals are hysteresis signals (edge detection).
49	RST	I	Reset input pin.
50	X0A	A	Crystal oscillator pins (32 KHz) .
51	X1A		

(Continued)

MB89550A Series

Pin No.	Pin Name	Circuit Type	Function
52	MODA	F	Operating mode setting pin.
53	X0	A	Crystal oscillator pins (Max12.5 MHz) .
54	X1		
55	P80/ $\overline{\text{INT24}}$	E	General purpose I/O port. Also functions as an external interrupt 2 input pin. External interrupt 2 input signals are hysteresis signals (level detection).
56	V _{ss}	—	Power supply (GND) pin.
57	P81/ $\overline{\text{INT25}}$	E	General purpose I/O ports. Also function as external interrupt 2 input pins. External interrupt 2 input signals are hysteresis signals (level detection).
58	P82/ $\overline{\text{INT26}}$		
59	P83/ $\overline{\text{INT27}}$		
60	P20/UI	E	General purpose I/O ports. Also function as 8-bit serial I/O pins.
61	P21/UO	B	
62	P22/UCK	E	
63	P23/PPG1	B	General purpose I/O port. Also functions as the 6-bit PPG timer output.
64	P24/ $\overline{\text{INT20}}$	E	General purpose I/O ports. Also function as external interrupt 2 input pins. External interrupt 2 input signals are hysteresis signals (level detection).
65	P25/ $\overline{\text{INT21}}$		
66	P26/ $\overline{\text{INT22}}$		
67	P27/ $\overline{\text{INT23}}$		
68	P30	K	N-ch open drain I/O pins.
69	P31		
70	DAOUT2	C	D/A converter output pins.
71	DAOUT1		
72	DVR	—	D/A converter reference voltage input pin.
73	P84/TO21	B	General purpose I/O ports. Also function as 8/16-bit timer pins.
74	P85/TO22		
75	P86/EC2/ LCLK	E	<ul style="list-style-type: none"> • P84 can be used as the output for the main clock×2 pulse. • P86 can be used as the event counter input or sub-clock pulse output.
76	P87/EC3	E	General purpose I/O port. Also functions as a 16-bit timer pin.
77	P40/TO11/ WTO	B	General purpose I/O ports. Also function as 8/16-bit timer pins.
78	P41/TO12/ HCLK		
79	P42/ PWM1/ EC1	E	General purpose I/O ports. Also function as PWM timer pins.
80	P43/PWM2	B	

(Continued)

MB89550A Series

(Continued)

Pin No.	Pin Name	Circuit Type	Function
81	P44/SCK	E	General purpose I/O ports. Also function as UART pins.
82	P45/SO	B	
83	P46/SI	J	
84	P47/PWC	J	General purpose I/O port. Also functions as the PWC timer pin.
85	C1	—	Step-up voltage circuit capacitance connection pins.
86	C0		
87	V0	—	LCD drive power supply pins.
88	V1		
89	V2		
90	V3		
91	COM0	H	Dedicated LCDC common output pins.
92	COM1		
93	COM2		
94	COM3		
95	SEG00	H	Dedicated LCDC segment output pins.
96	SEG01		
97	SEG02		
98	V _{cc1}	—	Power supply (3V) pin.
99	SEG03	H	Dedicated LCDC segment output pins.
100	SEG04		

MB89550A Series

I/O CIRCUIT TYPES

Type	Circuit	Remarks
A	<p>X1 (X1A)</p> <p>X0 (X0A)</p> <p>Main clock control signal (Sub-clock control signal)</p>	<p>Oscillation feedback resistance</p> <ul style="list-style-type: none"> • High speed side = approx. 1 MΩ • Low speed side = approx. 4.5 MΩ
B	<p>R</p> <p>Pch</p> <p>Pch</p> <p>Nch</p> <p>Pull-up control register</p> <p>Input control signal</p>	<ul style="list-style-type: none"> • CMOS I/O
C	<p>R</p> <p>Pch</p> <p>Nch</p> <p>Output enable</p> <p>Analog output</p>	<ul style="list-style-type: none"> • D/A output
D	<p>R</p> <p>Pch</p> <p>Pch</p> <p>Nch</p> <p>Pull-up control register</p> <p>Input control signal</p> <p>Port input</p> <p>Analog input</p>	<ul style="list-style-type: none"> • A/D input • CMOS I/O

(Continued)

Type	Circuit	Remarks
E		<ul style="list-style-type: none"> • CMOS I/O • Hysteresis input (for external interrupt 0, 1, 2 input)
F		<ul style="list-style-type: none"> • CMOS input
G		<ul style="list-style-type: none"> • LCDC output • N-ch open drain I/O
H		<ul style="list-style-type: none"> • LCDC output
I		<ul style="list-style-type: none"> • Hysteresis input • Pull-up resistance
J		<ul style="list-style-type: none"> • Hysteresis input • N-ch open drain I/O

(Continued)

MB89550A Series

(Continued)

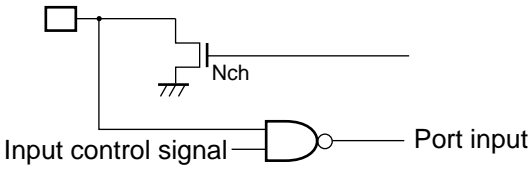
Type	Circuit	Remarks
K		<ul style="list-style-type: none">• N-ch open drain I/O

■ HANDLING DEVICES

- Maximum rated voltage (Prevention of latchup)
Be careful never to exceed maximum rated voltages.
In CMOS IC devices, a condition known as latch-up may occur if voltages higher than V_{CC} or lower than V_{SS} are applied to input or output pins other than medium- or high-voltage pins, or if the voltage applied between V_{CC} and V_{SS} exceeds the rated voltage level.
When latch-up occurs, the power supply current increases rapidly resulting in thermal damage to circuit elements. Therefore it is necessary to ensure that maximum ratings are not exceeded in circuit operation.
Similarly, when turning the analog power supply on or off, it is necessary to ensure that the analog power supply voltages (AV_{CC} , AVR , and DVR) and analog input voltages do not exceed the digital power supply (V_{CC}).
- Power supply voltages
Power supply voltages should be kept as stable as possible.
Rapid fluctuation of the voltage may cause the device to operate abnormally, even if the voltage remains within the allowed operating range.
As a standard for power supply voltage stability, it is recommended that the peak-to-peak V_{CC} ripple voltage at commercial supply frequency (50 Hz to 60 Hz) be 10% or less of V_{CC} . Also when the power supply is turned on or off the transient voltage fluctuation be no more than 0.1V/ms or less.
- Treatment of unused input pins
Leaving unused input pins unconnected can cause abnormal operation. Unused input pins should always be pulled up or down.
- Treatment of N.C. pins
N.C. (not connected) pins should always be left open.
- Treatment of power supply pins on devices with A/D or D/A converters
Even when the A/D or D/A converters are not in use, be sure to make the necessary connections to ensure that $AV_{CC} = V_{CC}$, $AV_{SS} = AVR = DVR = V_{SS}$.
- Precautions on using an external clock
An oscillation stabilization delay occurs after a power-on reset or when recovering from sub-clock or stop mode, even if an external clock is used.
- Treatment of unused dedicated LCD pins
Dedicated SEG output pins should be left open when not in use.
- Handling of ports also used as segment pins
When a port is used as a segment pin, take care to ensure that the voltage applied to the pin does not exceed V_3 (the segment drive voltage). This precaution is particularly necessary in models with step-up voltage circuits. Note also that after power-on or during a reset, an "L" level default signal is output from the segment/port pin.
- Treatment of unused LCD pins
Connect the V_3 pin to V_{CC2} . The other dedicated LCD pins V_0 , V_1 , V_2 , C_0 , and C_1 should be pulled down.
- Executing programs on RAM
When programs are executed on RAM, debugging cannot be performed even with the use of the MB89PV550A.
- Wild register functions
Wild registers cannot be debugged with the MB89PV550A or tools. To verify operation, use the MB89P558A and perform in-place testing.

MB89550A Series

PROGRAMMING SPECIFICATIONS FOR ONE-TIME PROM PRODUCTS

The MB89P558A has a "PROM mode" with functions equivalent to the MBM27C1001, that enables the micro-controller to be programmed by writing from a general-purpose ROM programmer with the use of a special adapter. Note however that electronic signature mode is not available.

ROM Programmer Adapters

With some ROM programmers the insertion of approximately 0.1 μ F capacitance between V_{PP} and V_{SS} or between V_{CC} and V_{SS} allows more stable writing performance. The following table lists ROM programmer adapters.

ROM Programmer Adapters

Part No.	Package	Adapter Part No.
MB89P558A	FPT-100P-M05	ROM-100SQF-32DP-8LA2
	FPT-100P-M18	ROM-100SQF-32DP-8LA

- Inquiries
Sun Hayato Co., Ltd. : TEL 03-3986-0403

- PROM Mode Memory Map
The PROM mode memory map is shown below.

PROM Mode Memory Map

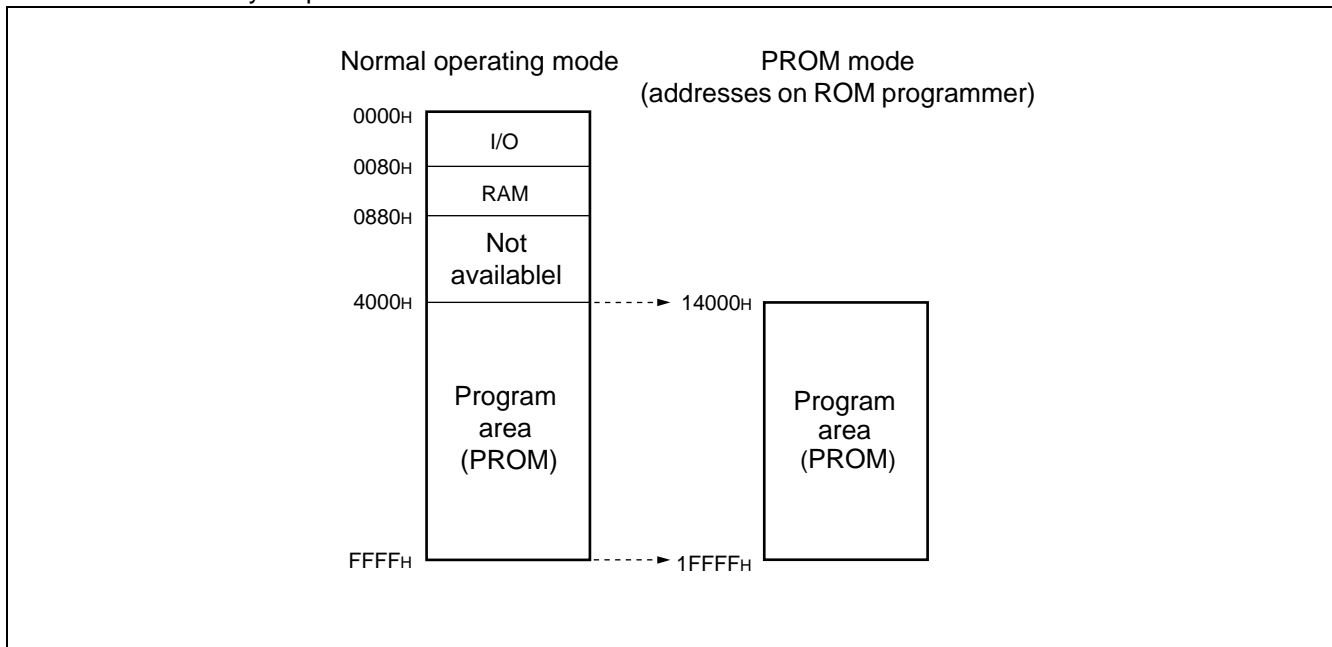

- EPROM Programming Procedure

- 1) Set the EPROM programmer type to MBM27C1001.
- 2) Load the program data into addresses 14000_H to 1FFFF_H in the EPROM programmer.
- 3) Use the EPROM programmer to program to addresses 14000_H to 1FFFF_H.

- Recommended Screening Conditions

High-temperature aging is the recommended method of screening unprogrammed one-time PROM microcontrollers before mounting.

The flow of the screening process is shown below.

Screening Flow

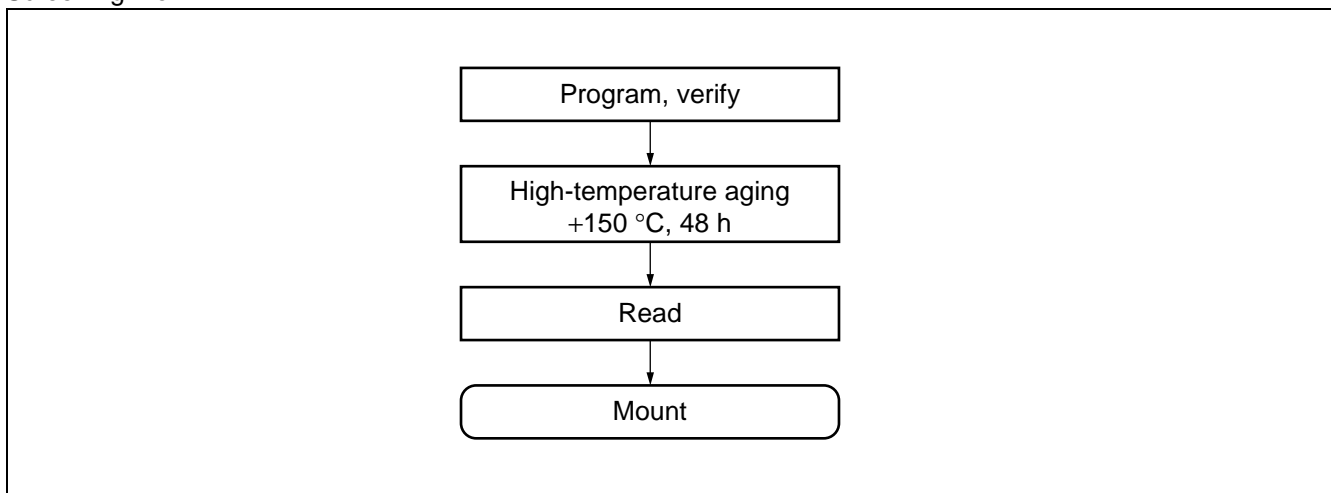

- About Writing Yields

The nature of chips before one-time writing of microcontroller programs to PROM prevents the use of all-bit writing tests. Therefore it is not possible to guarantee writing yields of 100% in some cases.

MB89550A Series

■ BLOCK DIAGRAM

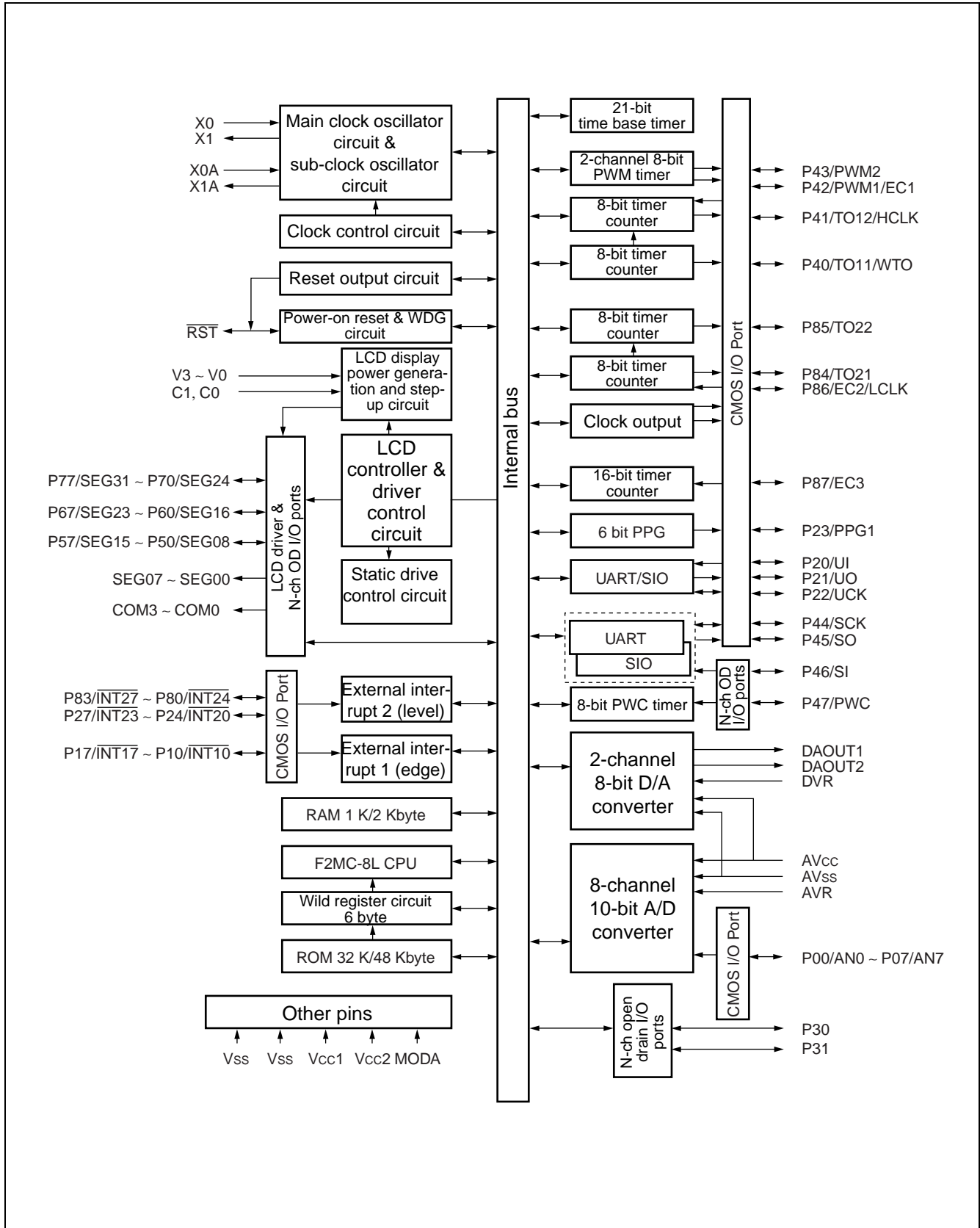

■ CPU CORE

Memory space

The MB89550A has 64 Kbytes of memory space, composed of the I/O area, RAM area, ROM area, and external area. The memory space includes general purpose registers, as well as areas used for special purposes such as vector tables.

- I/O Area (address : 0000_H to 007F_H)
 - This area is allocated to control registers and data registers for internal peripheral functions.
 - Because the I/O area is part of memory space, it can be accessed in the same ways. Direct addressing provides faster access.
- RAM Area
 - Static RAM is provided for use as an internal data area.
 - The size of internal RAM differs between product models.
 - High speed access is available to addresses 80_H to FF_H using direct addressing (the area available for use is restricted on some models).
 - Addresses 100_H to 1FF_H are used as the general-purpose register area.
 - If a reset is applied during writing to RAM, the value of data at the target addresses is not assured.
- ROM Area
 - ROM is provided for use as the internal program area.
 - The size of internal ROM differs between product models.
 - Addresses FFC0_H to FFFF_H are used for special purpose data such as vector tables.

Memory Map

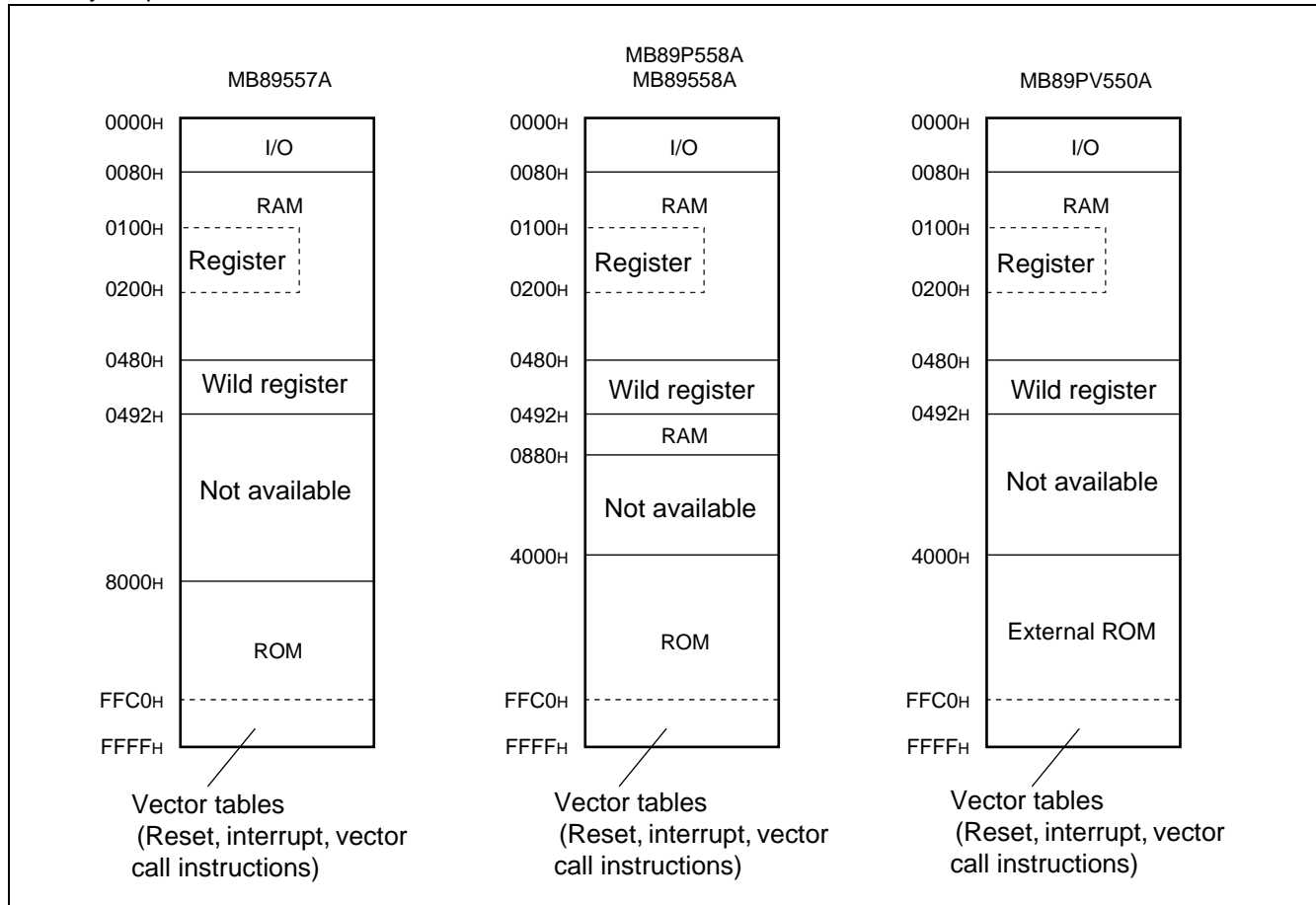

MB89550A Series

■ I/O MAP

Address	Abbreviation	Register Name	Read/Write	Initial Value
00H	PDR0	Port 0 data register	R/W	XXXXXXXX _B
01H	DDR0	Port 0 direction register	W	00000000 _B
02H	PDR1	Port 1 data register	R/W	XXXXXXXX _B
03H	DDR1	Port 1 direction register	W	00000000 _B
04H to 06H	Unused area			
07H	SYCC	System clock control register	R/W	XXXMM100 _B
08H	STBC	Standby control register	R/W	00010XXX _B
09H	WDTC	Watchdog control register	R/W	0XXXXXXXX _B
0AH	TBTC	Time base time control register	R/W	X0XXX000 _B
0BH	WPCR	Clock prescaler control register	R/W	X0XX0000 _B
0CH	PDR2	Port 2 data register	R/W	XXXXXXXX _B
0DH	DDR2	Port 2 direction register	R/W	00000000 _B
0EH	PDR3	Port 3 data register	R/W	-----11 _B
0FH	PDR4	Port 4 data register	R/W	11XXXXXXXX _B
10H	DDR4	Port 4 direction register	R/W	--000000 _B
11H	PDR5	Port 5 data register	R/W	00000000 _B
12H	Unused area			
13H	PDR6	Port 6 data register	R/W	00000000 _B
14H	Unused area			
15H	PDR7	Port 7 data register	R/W	00000000 _B
16H	Unused area			
17H	PDR8	Port 8 data register	R/W	XXXXXXXX _B
18H	DDR8	Port 8 direction register	R/W	00000000 _B
19H	Unused area			
1AH	T2CR#2	Timer 2 control register # 2(8/16-bit timer/counter -1)	R/W	X00000X0 _B
1BH	T1CR#1	Timer 1 control register # 1(8/16-bit timer/counter -1)	R/W	X00000X0 _B
1CH	T2DR#2	Timer 2 data register # 2(8/16-bit timer/counter -1)	R/W	XXXXXXXX _B
1DH	T1DR#1	Timer 1 data register # 1(8/16-bit timer/counter -1)	R/W	XXXXXXXX _B
1EH	T2CR#4	Timer 2 control register # 4(8/16-bit timer/counter -2)	R/W	X00000X0 _B
1FH	T1CR#3	Timer 1 control register # 3(8/16-bit timer/counter -2)	R/W	X00000X0 _B
20H	T2DR#4	Timer 2 data register # 4(8/16-bit timer/counter -2)	R/W	XXXXXXXX _B
21H	T1DR#3	Timer 1 data register # 3(8/16-bit timer/counter -2)	R/W	XXXXXXXX _B
22H	SMC1	Serial mode control register 1 (UART)	R/W	00000000 _B
23H	SRC1	Serial rate control register (UART)	R/W	--011000 _B

(Continued)

MB89550A Series

Address	Abbreviation	Register Name	Read/Write	Initial Value
24 _H	SSD1	Serial status and data register (UART)	R/W	00100-1X _B
25 _H	SIDR1/ SODR1	Serial input/serial output data register (UART)	R/W	XXXXXXXX _B
26 _H	SMC2	Serial mode control register 2 (UART)	R/W	--100001 _B
27 _H	CNTR1	PWM control register 1	R/W	00000000 _B
28 _H	CNTR2	PWM control register 2	R/W	000X0000 _B
29 _H	CNTR3	PWM control register 3	R/W	X000XXXX _B
2A _H	COMR1	PWM compare register 1	W	XXXXXXXX _B
2B _H	COMR2	PWM compare register 2	W	XXXXXXXX _B
2C _H	PCR1	PWC pulse width control register 1	R/W	000XX000 _B
2D _H	PCR2	PWC pulse width control register 2	R/W	00000000 _B
2E _H	PLBR	PWC reload buffer register	R/W	XXXXXXXX _B
2F _H	SMC21	Serial mode control register 1 (UART/SIO)	R/W	00000000 _B
30 _H	SMC22	Serial rate control register 2 (UART/SIO)	R/W	00000000 _B
31 _H	SSD2	Serial status and data register (UART/SIO)	R/W	00001XXX _B
32 _H	SIDR2/ SODR2	Serial input/serial output data register (UART/SIO)	R/W	XXXXXXXX _B
33 _H	SRC2	Baud rate generator reload register (UART/SIO)	R/W	XXXXXXXX _B
34 _H	ADC1	A/D control register 1	R/W	00000000 _B
35 _H	ADC2	A/D control register 2	R/W	X0000001 _B
36 _H	ADDL	A/D data register low	R/W	XXXXXXXX _B
37 _H	ADDH	A/D data register high	R/W	000000XX _B
38 _H to 3B _H	Unused area			
3C _H	TMCR	Timer control register (16-bit timer/counter)	R/W	XX000000 _B
3D _H	TCHR	Timer count register high (16-bit timer/counter)	R/W	00000000 _B
3E _H	TCLR	Timer count register low (16-bit timer/counter)	R/W	00000000 _B
3F _H	EIC1	External interrupt register 1	R/W	00000000 _B
40 _H	EIC2	External interrupt register 2	R/W	00000000 _B
41 _H	EIC3	External interrupt register 3	R/W	00000000 _B
42 _H	EIC4	External interrupt register 4	R/W	00000000 _B
43 _H	DACR	D/A control register	R/W	XXXXXX00 _B
44 _H	DADR1	D/A data register 1	R/W	XXXXXXXX _B
45 _H	DADR2	D/A data register 2	R/W	XXXXXXXX _B
46 _H to 55 _H	Unused area			
56 _H	EIE2	External interrupt 2 control register	R/W	00000000 _B

(Continued)

MB89550A Series

(Continued)

Address	Abbreviation	Register Name	Read/Write	Initial Value
57 _H	EIF2	External interrupt 2 flag register	R/W	XXXXXXXX _{0B}
58 _H	RCR1	6-bit PPG control register 1	R/W	0000000 _{0B}
59 _H	RCR2	6-bit PPG control register 2	R/W	0-000000 _{0B}
5A _H	CKR	Clock output control register	R/W	XXXXXXXX _{00B}
5B _H	LCR1	LCDC control register 1	R/W	00010000 _{0B}
5C _H	LCR2	LCDC control register 2	R/W	00000000 _{0B}
5D _H	LCR3	LCDC control register 3	R/W	---00000 _{0B}
5E _H	LCD1	LCD static display register 1	R/W	XXXXXXXX _{XB}
5F _H	LCD2	LCD static display register 2	R/W	XXXXXXXX _{XB}
60 _H to 6F _H	VRAM	LCD display RAM	R/W	XXXXXXXX _{XB}
70 _H	SMR	Serial mode register (8-bit serial I/O)	R/W	00000000 _{0B}
71 _H	SDR	Serial data register (8-bit serial I/O)	R/W	XXXXXXXX _{XB}
72 _H	PORR0	Port 0 pull-up option setting register	R/W	11111111 _B
73 _H	PURR1	Port 1 pull-up option setting register	R/W	11111111 _B
74 _H	PURR2	Port 2 pull-up option setting register	R/W	11111111 _B
75 _H	PURR4	Port 4 pull-up option setting register	R/W	11111111 _B
76 _H	PURR8	Port 8 pull-up option setting register	R/W	11111111 _B
77 _H	WREN	Wild register/address comparator enable register	R/W	--000000 _{0B}
78 _H	Unused area			
79 _H	ADEN	A/D port input enable register	R/W	11111111 _B
7A _H	Unused area			
7B _H	ILR1	Interrupt level setting register 1	W	11111111 _B
7C _H	ILR2	Interrupt level setting register 2	W	11111111 _B
7D _H	ILR3	Interrupt level setting register 3	W	11111111 _B
7E _H	ILR4	Interrupt level setting register 4	W	11111111 _B
7F _H	Unused area			

• **Extended I/O Area**

Address	Abbreviation	Register Name	Read/Write	Initial Value
480 _H	WRARH1	H address setting register 1	R/W	XXXXXXXX
481 _H	WRARL1	L address setting register 1	R/W	XXXXXXXX
482 _H	WRDR1	Data setting register 1	W	XXXXXXXX
483 _H	WRARH2	H address setting register 2	R/W	XXXXXXXX
484 _H	WRARL2	L address setting register 2	R/W	XXXXXXXX
485 _H	WRDR2	Data setting register 2	W	XXXXXXXX
486 _H	WRARH3	H address setting register 3	R/W	XXXXXXXX
487 _H	WRARL3	L address setting register 3	R/W	XXXXXXXX
488 _H	WRDR3	Data setting register 3	W	XXXXXXXX
489 _H	WRARH4	H address setting register 4	R/W	XXXXXXXX
48A _H	WRARL4	L address setting register 4	R/W	XXXXXXXX
48B _H	WRDR4	Data setting register 4	W	XXXXXXXX
48C _H	WRARH5	H address setting register 5	R/W	XXXXXXXX
48D _H	WRARL5	L address setting register 5	R/W	XXXXXXXX
48E _H	WRDR5	Data setting register 5	W	XXXXXXXX
48F _H	WRARH6	H address setting register 6	R/W	XXXXXXXX
490 _H	WRARL6	L address setting register 6	R/W	XXXXXXXX
491 _H	WRDR6	Data setting register 6	W	XXXXXXXX

○ Read/write notation

- R/W : Reading and writing enabled
- R : Read-only
- W : Write only

○ Initial value notation

- 0 : Initial value of bit is "0".
- 1 : Initial value of bit is "1".
- X : Initial value of bit is undefined.

Note : Areas indicated as "unused area" are not to be used.

MB89550A Series

■ ELECTRICAL CHARACTERISTICS

1. Absolute Maximum Ratings

(AVSS = VSS = 0 V)

Parameter	Symbol	Rating		Unit	Remarks
		Min	Max		
Power supply voltage	V _{CC1}	V _{SS} - 0.3	V _{SS} + 4.0	V	V _{CC1} not to exceed V _{CC2} .*
	V _{CC2}	V _{SS} - 0.3	V _{SS} + 6.0		
A/D converter reference input voltage	AVR	V _{SS} - 0.3	V _{SS} + 6.0	V	
D/A converter reference input voltage	DVR	V _{SS} - 0.3	V _{SS} + 6.0	V	
LCD power supply voltage	V0-V3	V _{SS} - 0.3	V _{SS} + 6.0	V	On models without step-up circuits V0-V3 are not to exceed V _{CC2} .
Input voltage	V _{I1}	V _{SS} - 0.3	V _{CC2} + 0.3	V	Pins other than P50 to P57, P60 to P67, P70 to P77, P46, P47, P30, P31
	V _{I2}	V _{SS} - 0.3	V3	V	P50 to P57, P60 to P67, P70 to P77
	V _{I3}	V _{SS} - 0.3	V _{SS} + 6.0	V	P46, P47, P30, P31
Output voltage	V _{O1}	V _{SS} - 0.3	V _{CC2}	V	Pins other than P50 to P57, P60 to P67, P70 to P77, P46, P47, P30, P31
	V _{O2}	V _{SS} - 0.3	V3	V	P50 to P57, P60 to P67, P70 to P77
	V _{O3}	V _{SS} - 0.3	V _{SS} + 6.0	V	P46, P47, P30, P31
"L" level maximum output current	I _{OL1}	—	15	mA	Pins other than P22/UCK, P23/PPG1
	I _{OL2}	—	30	mA	P22/UCK, P23/PPG1
"L" level average output current	I _{OLAV1}	—	4	mA	Pins other than P22/UCK, P23/PPG1 average value (operating current × operating ratio)
	I _{OLAV2}	—	15	mA	P22/UCK, P23/PPG1 average value (operating current × operating ratio)
"L" level total maximum output current	ΣI _{OL}	—	100	mA	
"L" level total average output current	ΣI _{OLAV}	—	60	mA	average value (operating current × operating ratio)
"H" level maximum output current	I _{OH1}	—	-15	mA	Pins other than P22/UCK, P23/PPG1
	I _{OH2}	—	-30	mA	P22/UCK, P23/PPG1

(Continued)

MB89550A Series

(Continued)

Parameter	Symbol	Rating		Unit	Remarks
		Min	Max		
“H” level average output current	I_{OHAV}	—	-4	mA	Pins other than P22/UCK, P23/PPG1 and open drain output pins average value (operating current × operating ratio)
	I_{OHAV}	—	-15	mA	P22/UCK, P23/PPG1 average value (operating current × operating ratio)
“H” level total maximum output current	ΣI_{OH}	—	-50	mA	
“H” level total average output current	ΣI_{OHAV}	—	-30	mA	average value (operating current × operating ratio)
Power consumption	P_D	—	300	mW	
Operating temperature	T_A	-40	+85	°C	
Storage temperature	T_{stg}	-55	+150	°C	

* : Set AV_{CC} to the same potential as V_{CC} .
Also ensure that AVR and DVR do not exceed $AV_{CC} + 0.3$ V.

WARNING: Semiconductor devices can be permanently damaged by application of stress (voltage, current, temperature, etc.) in excess of absolute maximum ratings. Do not exceed these ratings.

MB89550A Series

2. Recommended Operating Conditions

(AVSS = VSS = 0 V)

Item	Symbol	Rating		Unit	Remark
		Min	Max		
Power supply voltage*3	V _{CC1}	2.2*1	3.6	V	Guaranteed normal operating range (MB89557A/558A)
	V _{CC2}	2.2*1	5.5	V	
	V _{CC1}	—	—	V	Guaranteed normal operating range (MB89P558A)
	V _{CC2}	2.7*2	5.5	V	
	V _{CC1} , V _{CC2}	1.5	3.6	V	To maintain RAM state in stop mode
A/D converter reference voltage input*4	AVR	V _{CC1}	AV _{CC}	V	Guaranteed normal operating range
D/A converter reference voltage input*4	DVR	V _{CC1}	AV _{CC}	V	Guaranteed normal operating range
LCD supply voltage	V0-V3	V _{SS}	V _{CC2}	V	Models without step-up circuit, pins V0 to V3. LCD power supply range and maximum value are determined by the characteristics of the LCD display element used.
Operating temperature	T _A	-40	+85	°C	

*1 : The operating power supply voltage differs depending on the instruction cycle time of the operating frequency. See Figure 1.

*2 : The operating power supply voltage differs depending on the instruction cycle time of the operating frequency. See Figure 2. Note also that on the MB89PV550A the input to the V_{CC1} pin is cut off internally, and on the MB89P558A the V_{CC1} pin is used as the V_{PP} pin for on-board writing.

*3 : AV_{CC} and V_{CC2} should be set to the same potential. Also, care must be taken to ensure that V_{CC1} does not exceed V_{CC2}.

*4 : Care must be taken to ensure that the relation between AVR and DVR is such that "V_{CC1} ≤ AVR (DVR) ≤ AV_{CC} + 0.3 V".

Figure 1. Operating Voltage vs. Operating Frequency (MB89558A/557A)

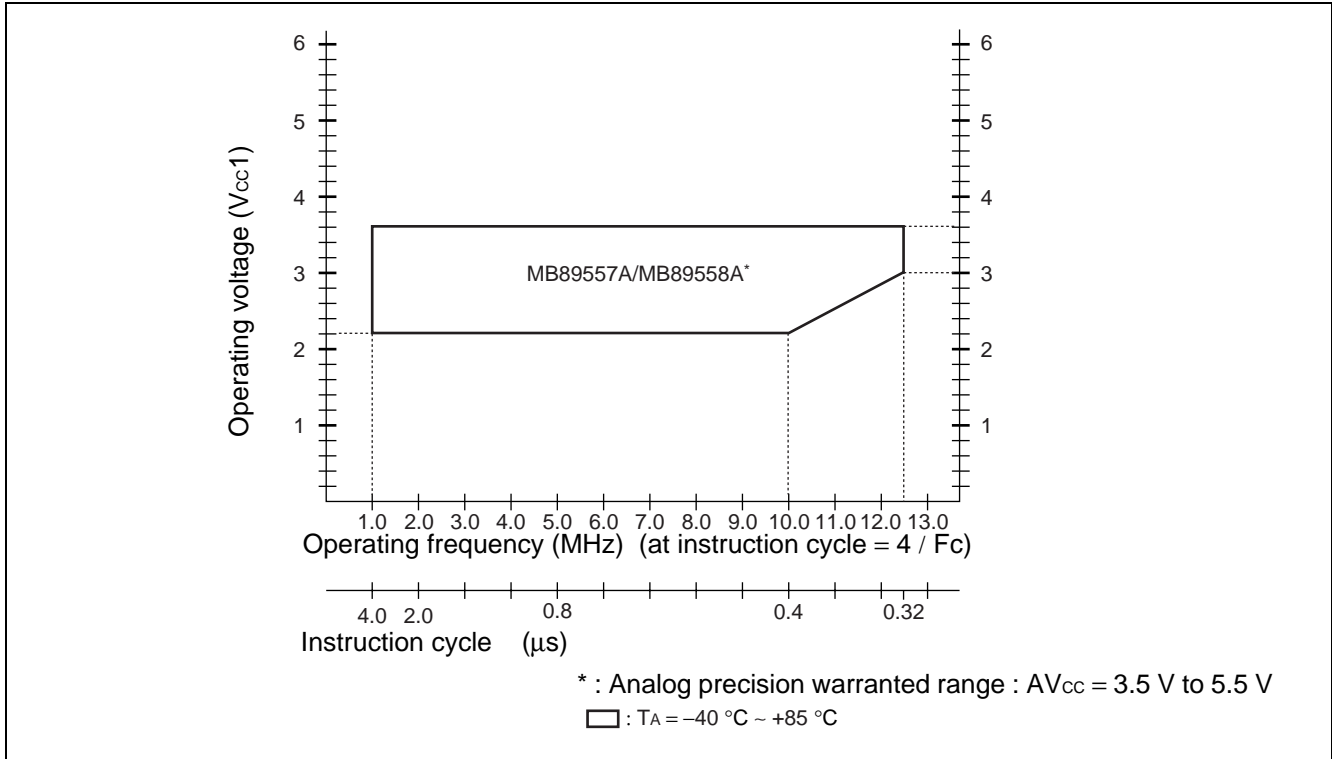
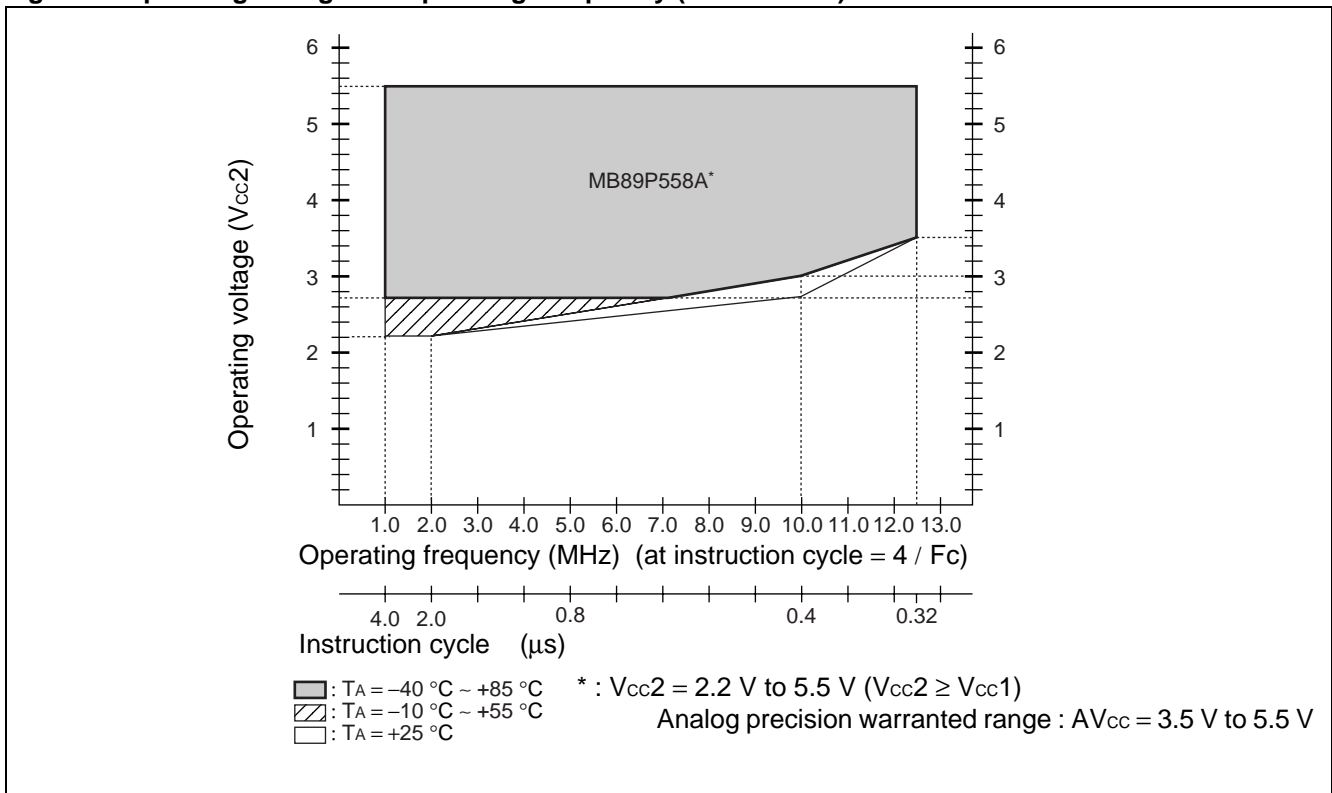

Figure 2. Operating Voltage vs. Operating Frequency (MB89P558A)



MB89550A Series

WARNING: The recommended operating conditions are required in order to ensure the normal operation of the semiconductor device. All of the device's electrical characteristics are warranted when the device is operated within these ranges.

Always use semiconductor devices within their recommended operating condition ranges. Operation outside these ranges may adversely affect reliability and could result in device failure.

No warranty is made with respect to uses, operating conditions, or combinations not represented on the data sheet. Users considering application outside the listed conditions are advised to contact their FUJITSU representatives beforehand.

MB89550A Series

3. DC Characteristics

($V_{CC} = AVR = DVR = V_{CC2} = 5.0\text{ V}$, $V_{SS} = 0\text{ V}$, $T_A = -40\text{ }^\circ\text{C}$ to $+85\text{ }^\circ\text{C}$)

Parameter	Symbol	Pin name	Condition	Value			Unit	Remarks
				Min	Typ	Max		
"H" level input voltage	V_{IH1}	P00 to P07, P10 to P17, P20 to P27, P40 to P45, P80 to P87	—	$0.7 V_{CC2}$	—	$V_{CC2} + 0.3$	V	
	V_{IH2}	P50 to P57, P60 to P67, P70 to P77	—	$0.7 V_{CC2}$	—	V3	V	V_{IH2} not to exceed V3.
	V_{IH3}	P46, P47, P30, P31	—	$0.7 V_{CC2}$	—	$V_{SS} + 5.5$	V	
	V_{IHS1}	$\overline{\text{INT10}}$ to $\overline{\text{INT17}}$, UI, UCK, $\overline{\text{INT20}}$ to $\overline{\text{INT27}}$, SCK, EC1, EC2, EC3, $\overline{\text{RST}}$, MODA	—	$0.8 V_{CC2}$	—	$V_{CC2} + 0.3$	V	Hysteresis input
	V_{IHS2}	SI, PWC	—	$0.8 V_{CC2}$	—	$V_{SS} + 5.5$	V	Hysteresis input
"L" level input voltage	V_{IL1}	P00 to P07, P10 to P17, P20 to P27, P30, P31, P40 to P47, P80 to P87	—	$V_{SS} - 0.3$	—	$0.3 V_{CC2}$	V	
	V_{IL2}	P50 to P57, P60 to P67, P70 to P77	—	$V_{SS} - 0.3$	—	$0.3 V_{CC2}$	V	V_{IL2} not to exceed V3.
	V_{ILS}	$\overline{\text{INT10}}$ to $\overline{\text{INT17}}$, UI, UCK, $\overline{\text{INT20}}$ to $\overline{\text{INT27}}$, SCK, EC1, EC2, EC3, $\overline{\text{RST}}$, MODA, SI, PWC	—	$V_{SS} - 0.3$	—	$0.2 V_{CC2}$	V	Hysteresis input
Voltage applied to open drain output pins	V_{D1}	P46, P47, P30, P31	—	$V_{SS} - 0.3$	—	$V_{SS} + 5.5$	V	
	V_{D2}	P50 to P57, P60 to P67, P70 to P77	—	$V_{SS} - 0.3$	—	V3	V	V_{D2} not to exceed V3.
"H" level output voltage	V_{OH1}	P00 to P07, P10 to P17, P20, P21, P24 to P27, P40 to P45, P80 to P87	$I_{OH} = -2.0\text{ mA}$	4.0	—	—	V	
	V_{OH2}	P22, P23	$I_{OH} = -4.0\text{ mA}$	4.0	—	—	V	
"L" level output voltage	V_{OL1}	P00 to P07, P10 to P17, P20, P21, P24 to P27, P30, P31, P40 to P47, P50 to P57, P60 to P67, P70 to P77, P80 to P87	$I_{OL} = 4.0\text{ mA}$	—	—	0.4	V	
	V_{OL2}	P22, P23	$I_{OL} = 12\text{ mA}$	—	—	0.4	V	
Input leak current (Hi-Z output leak current)	I_{L1}	P00 to P07, P10 to P17, P20 to P27, P30, P31 P40 to P47, P50 to P57, P60 to P67, P70 to P77, P80 to P87, MODA	$0.0\text{V} < V_i < V_{CC2}$	—	—	± 5	μA	Without pull-up resistor option

(Continued)

MB89550A Series

($V_{CC} = AVR = DVR = V_{CC2} = 5.0\text{ V}$, $V_{SS} = V_{SS} = 0\text{ V}$, $T_A = -40\text{ }^\circ\text{C}$ to $+85\text{ }^\circ\text{C}$)

Parameter	Symbol	Pin name	Condition	Value			Unit	Remarks
				Min	Typ	Max		
Pull-up resistance	R_{PULL}	P00 to P07, P10 to P17, P20 to P27, P40 to P45, P80 to P87, \overline{RST}	$V_I = 0.0\text{ V}$	25	50	100	$k\Omega$	With pull-up resistor option
Power supply current	I_{CC1}	V_{CC1}	$V_{CC1} = 3.0\text{ V}$ $V_{CC2} = 5.0\text{ V}$ $F_{CH} = 12.5\text{ MHz}$	—	4.5	6	mA	$t_{inst} = 0.32\text{ }\mu\text{s}$ MB89557A/ 558A
		V_{CC2}	$V_{CC2} = 5.0\text{ V}$ $F_{CH} = 12.5\text{ MHz}$	—	22	25	mA	$t_{inst} = 0.32\text{ }\mu\text{s}$ MB89P558A
	I_{CC2}	V_{CC1}	$V_{CC1} = 3.0\text{ V}$ $V_{CC2} = 5.0\text{ V}$ $F_{CH} = 10.0\text{ MHz}$	—	1.4	2.1	mA	$t_{inst} = 6.4\text{ }\mu\text{s}$ MB89557A/ 558A
		V_{CC2}	$V_{CC2} = 3.0\text{ V}$ $F_{CH} = 10.0\text{ MHz}$	—	5.3	9	mA	$t_{inst} = 6.4\text{ }\mu\text{s}$ MB89P558A
	I_{CCS1}	V_{CC1}	$V_{CC1} = 3.0\text{ V}$ $V_{CC2} = 3.0\text{ V}$ $F_{CH} = 12.5\text{ MHz}$	—	2	3	mA	Sleep mode $t_{inst} = 0.32\text{ }\mu\text{s}$ MB89557A/ 558A
		V_{CC2}	$V_{CC2} = 5.0\text{ V}$ $F_{CH} = 12.5\text{ MHz}$	—	6.2	10	mA	Sleep mode $t_{inst} = 0.32\text{ }\mu\text{s}$ MB89P558A
	I_{CCS2}	V_{CC1}	$V_{CC1} = 3.0\text{ V}$ $V_{CC2} = 3.0\text{ V}$ $F_{CH} = 10.0\text{ MHz}$	—	0.35	1	mA	Sleep mode $t_{inst} = 6.4\text{ }\mu\text{s}$ MB89557A/ 558A
		V_{CC2}	$V_{CC2} = 3.0\text{ V}$ $F_{CH} = 10.0\text{ Hz}$	—	0.6	2	mA	Sleep mode $t_{inst} = 6.4\text{ }\mu\text{s}$ MB89P558A
	I_{CCL}	V_{CC1}	$V_{CC1} = 3.0\text{ V}$ $V_{CC2} = 5.0\text{ V}$ $F_{CL} = 32\text{ kHz}$ $T_A = +25\text{ }^\circ\text{C}$	—	30	50	μA	Sub-mode MB89557A/ 558A
		V_{CC2}	$V_{CC2} = 3.0\text{ V}$ $F_{CL} = 32\text{ kHz}$ $T_A = +25\text{ }^\circ\text{C}$	—	4	8	mA	Sub-mode MB89P558A
	I_{CCLS}	V_{CC1}	$V_{CC1} = 3.0\text{ V}$ $V_{CC2} = 3.0\text{ V}$ $F_{CL} = 32\text{ kHz}$ $T_A = +25\text{ }^\circ\text{C}$	—	10	20	μA	Sub-sleep mode MB89557A/ 558A
		V_{CC2}	$V_{CC2} = 3.0\text{ V}$ $F_{CL} = 32\text{ kHz}$ $T_A = +25\text{ }^\circ\text{C}$	—	20	50	μA	Sub-sleep mode MB89P558A

(Continued)

MB89550A Series

(AV_{CC} = AVR = DVR = V_{CC2} = 5.0 V, AV_{SS} = V_{SS} = 0 V, T_A = -40 °C to +85 °C)

Parameter	Symbol	Pin name	Condition	Value			Unit	Remarks
				Min	Typ	Max		
Power supply current	I _{CC1}	V _{CC1}	V _{CC1} = 3.0 V V _{CC2} = 3.0 V T _A = +25 °C F _{CL} = 32 kHz	—	5	15	μA	Clock mode Main stop MB89557A/ 558A
		V _{CC2}	V _{CC2} = 3.0 V F _{CL} = 32 kHz T _A = +25 °C	—	12	25	μA	Clock mode Main stop MB89P558A
	I _{CC2}	V _{CC1}	V _{CC1} = 3.0 V V _{CC2} = 3.0 V F _{CL} = 32 kHz T _A = +25 °C	—	5	10	μA	T _A = +25 °C Sub- stop MB89557A/ 558A
		V _{CC2}	V _{CC2} = 3.0 V F _{CL} = 32 kHz T _A = +25 °C	—	5	10	μA	T _A = +25 °C Sub- stop MB89P558A
	I _A	AV _{CC}	V _{CC1} = 3.0 V AV _{CC} = V _{CC2} = 5.0 V F _{CH} = 12.5 MHz	—	2	5	mA	A/D converter running MB89557A/ 558A
		AV _{CC}	V _{CC2} = 5.0 V F _{CH} = 12.5 MHz	—	3	6	mA	A/D converter running MB89P558A
	I _{AH}	AV _{CC}	V _{CC1} = 3.0 V, AV _{CC} = V _{CC2} = 5.0 V F _{CH} = 12.5 MHz T _A = +25 °C	—	—	10	μA	T _A = +25 °C A/D converter stopped MB89557A/ 558A
		AV _{CC}	V _{CC2} = 5.0 V F _{CH} = 12.5 MHz T _A = +25 °C	—	—	10	μA	T _A = +25 °C A/D converter stopped MB89P558A
LCD divider resistance	R _{LCD}	—	V _{CC} to V ₀ at V _{CC} = 5 V	—	500	—	kΩ	
COM0 to COM3 output impedance	R _{VCOM}	COM0 to COM3	V1 to V3 = 5 V	—	—	5	kΩ	
SEG0 to SEG31 output impedance	R _{VSEG}	SEG0 to SEG31		—	—	15	kΩ	
LCD leak current	I _{LCDL}	V0 to V3, COM0 to COM3, SEG0 to SEG31	—	—	—	±5	μA	

(Continued)

MB89550A Series

(Continued)

Parameter	Sym- bol	Pin name	Condition	Value			Unit	Remarks
				Min	Typ	Max		
LCD step-up output voltage	V _{OV3}	V3	V1 = 1.5 V	—	4.5	—	V	Models with step-up circuits only
	V _{OV2}	V2		—	3.0	—	V	
Reference voltage input impedance	R _{RIN}	V1	—	600	1000	1400	kΩ	Models with step-up circuits only
Input capacitance	C _{IN}	Pins other than V _{CC} , V _{SS}	F _{CH} = 1 MHz	—	10	—	pF	
V1 input voltage	V _{I1}	V1	I _{IN} = 0 μA	—	1.5	—	V	Models with step-up circuits only

4. AC Characteristics

(1) Reset Timing

(DVR = $V_{CC1} = 3\text{ V}$, $AV_{SS} = V_{SS} = 0\text{ V}$, $T_A = -40\text{ }^\circ\text{C}$ to $+85\text{ }^\circ\text{C}$)

Parameter	Symbol	Confition	Rating		Unit	Remarks
			Min	Max		
RST "L" pulse width	t_{ZLZH}	—	$48 t_{HCLY}$	—	ns	

Note : t_{HCLY} is the main clock oscillator period.

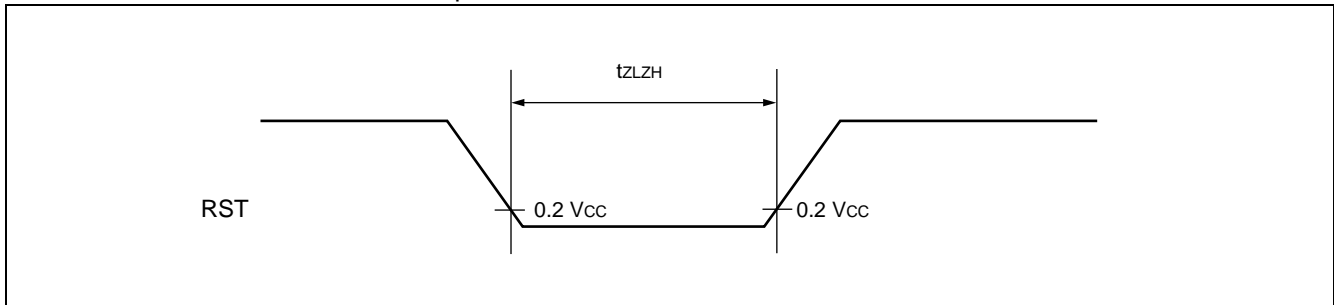

(2) Power-on Reset

($AV_{SS} = V_{SS} = 0\text{ V}$, $T_A = -40\text{ }^\circ\text{C}$ to $+85\text{ }^\circ\text{C}$)

Parameter	Symbol	Confition	Rating		Unit	Remarks
			Min	Max		
Power supply rise time	t_R	—	0.05	50	ms	
Power supply cutoff time	t_{OFF}	—	1	—	ms	For repeated operation

Note : Be sure that the power supply rise time is less than the selected oscillator stabilization period. Also, when varying the supply voltage during operation, it is recommended that the supply voltage be increased gradually.

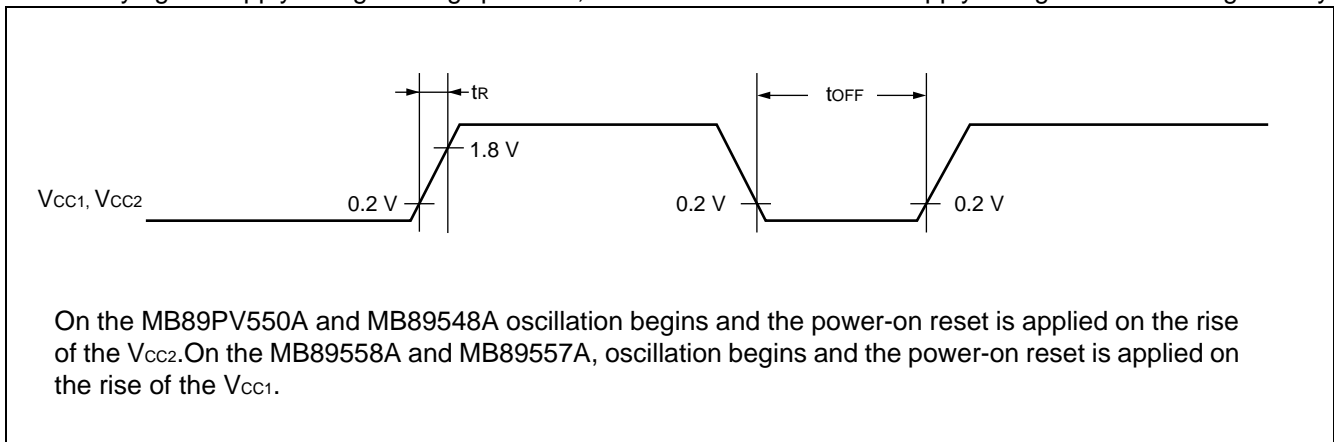

MB89550A Series

(3) Power Supply Voltage

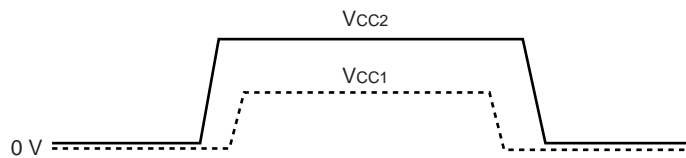

Be sure that the power supply is set so that $V_{CC2} \geq V_{CC1}$.

The MB89PV550A and MB89P558A operate on the V_{CC2} power supply only.

On the MB89558A and MB89557A, V_{CC1} is the power supply for internal CPU operation, and V_{CC2} is the I/O power supply.

(4) Clock Timing

($A_{VSS} = V_{SS} = 0\text{ V}$, $T_A = -40\text{ }^\circ\text{C}$ to $+85\text{ }^\circ\text{C}$)

Parameter	Symbol	Pin Name	Condi- tion	Value			Unit	Remarks
				Min	Typ	Max		
Clock frequency	F_{CH}	X0, X1	—	1	—	12.5	MHz	
	F_{CL}	X0A, X1A		—	32.768	—	kHz	
Clock cycle time	t_{HCYL}	X0, X1		80	—	1000	ns	
	t_{LCYL}	X0A, X1A		—	30.5	—	μs	
Input clock pulse width	P_{WH1} P_{WL1}	X0		20	—	—	ns	External clock
	P_{WH2} P_{WL2}	X0A		—	15.2	—	μs	External clock
Input clock rise, fall time	t_{CR} t_{CF}	X0		—	—	10	ns	External clock

- X0 and X1 clock timing and input conditions

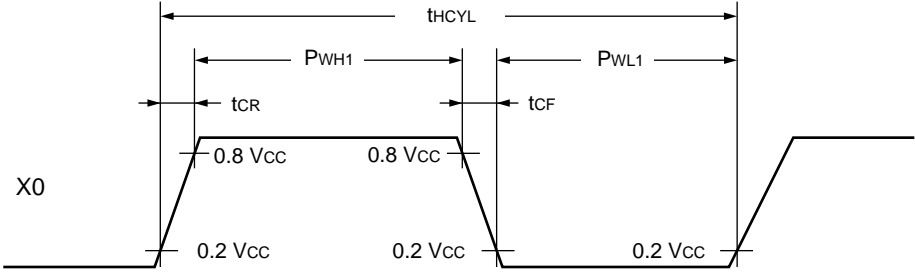

- Clock configurations

When using a crystal oscillator or ceramic oscillator

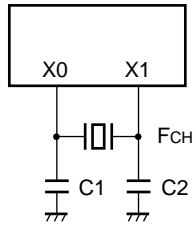

When using an external clock

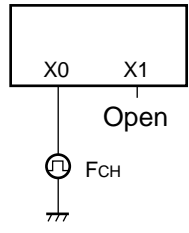

MB89550A Series

- X0A and X1A clock timing conditions

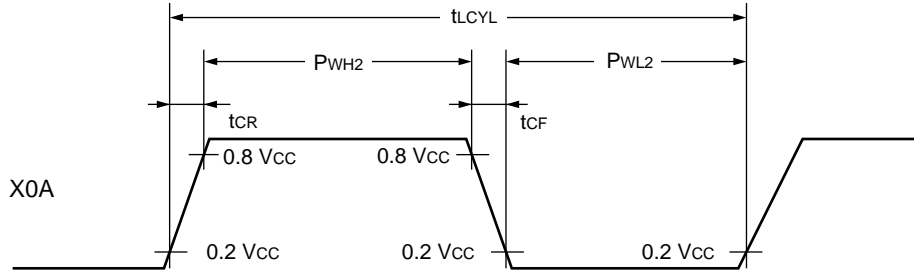

- Clock configurations

When using a crystal oscillator or ceramic oscillator

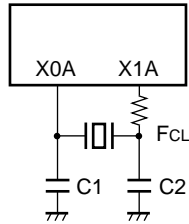

When using an external clock

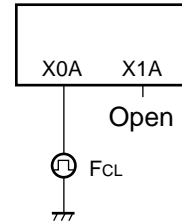

(5) Instruction Cycle

(AVss = Vss = 0 V, TA = -40 °C to +85 °C)

Parameter	Symbol	Value	Unit	Remarks
Instruction cycle (minimum instruction execution time)	t _{inst}	4/F _{CH} , 8/F _{CH} , 16/F _{CH} , 64/F _{CH} ,	μs	Operating at F _{CH} = 12.5 MHz (4/F _{CH}) t _{inst} = 0.32 μs
		2/F _{CL}	μs	Operating at F _{CL} = 32.768 kHz t _{inst} = 61.036 μs

Note : Instruction execution time settings differ for 12.5 MHz operation.

(6) Serial I/O timing

($V_{CC1} = 3.0\text{ V}$, $AV_{CC} = AVR = DVR = V_{CC2} = 5\text{ V}$, $AV_{SS} = V_{SS} = 0\text{ V}$, $T_A = -40\text{ }^\circ\text{C}$ to $+85\text{ }^\circ\text{C}$)

Parameter	Symbol	Pin Nme	Condition	Value		Unit	Remarks
				Min	Max		
Serial clock cycle time	t_{SCYC}	SCK, UCK	Internal clock operation	$2 t_{inst}^*$	—	μs	
SCK \downarrow →SO time UCK \downarrow →UO time	t_{SLOV}	SCK, SO, UCK, UO		-200	+200	ns	
Valid SI→SCK \uparrow Valid UI→UCK \uparrow	t_{IVSH}	SI, SCK		$1/2 t_{inst}^*$	—	μs	
SCK \uparrow → valid SI hold time UCK \uparrow → valid UI hold time	t_{SHIX}	SCK, SI, UCK, UI		$1/2 t_{inst}^*$	—	μs	
Serial clock "H" pulse width	t_{SHSL}	SCK, UCK	External clock operation	$1 t_{inst}^*$	—	μs	
Serial clock "L" pulse width	t_{LSLH}			$1 t_{inst}^*$	—	μs	
SCK \downarrow →SO time UCK \downarrow →UO time	t_{SLOV}	SCK, SO, UCK, UO		0	200	ns	
Valid SI→SCK \uparrow Valid UI→UCK \uparrow	t_{IVSH}	SI, SCK, UI, UCK		$1/2 t_{inst}^*$	—	μs	
SCK \uparrow → valid SI hold time UCK \uparrow → valid UI hold time	t_{SHIX}	SCK, SI, UCK, UI	$1/2 t_{inst}^*$	—	μs		

* : For a definition of t_{inst} see "(5) Instruction Cycle".

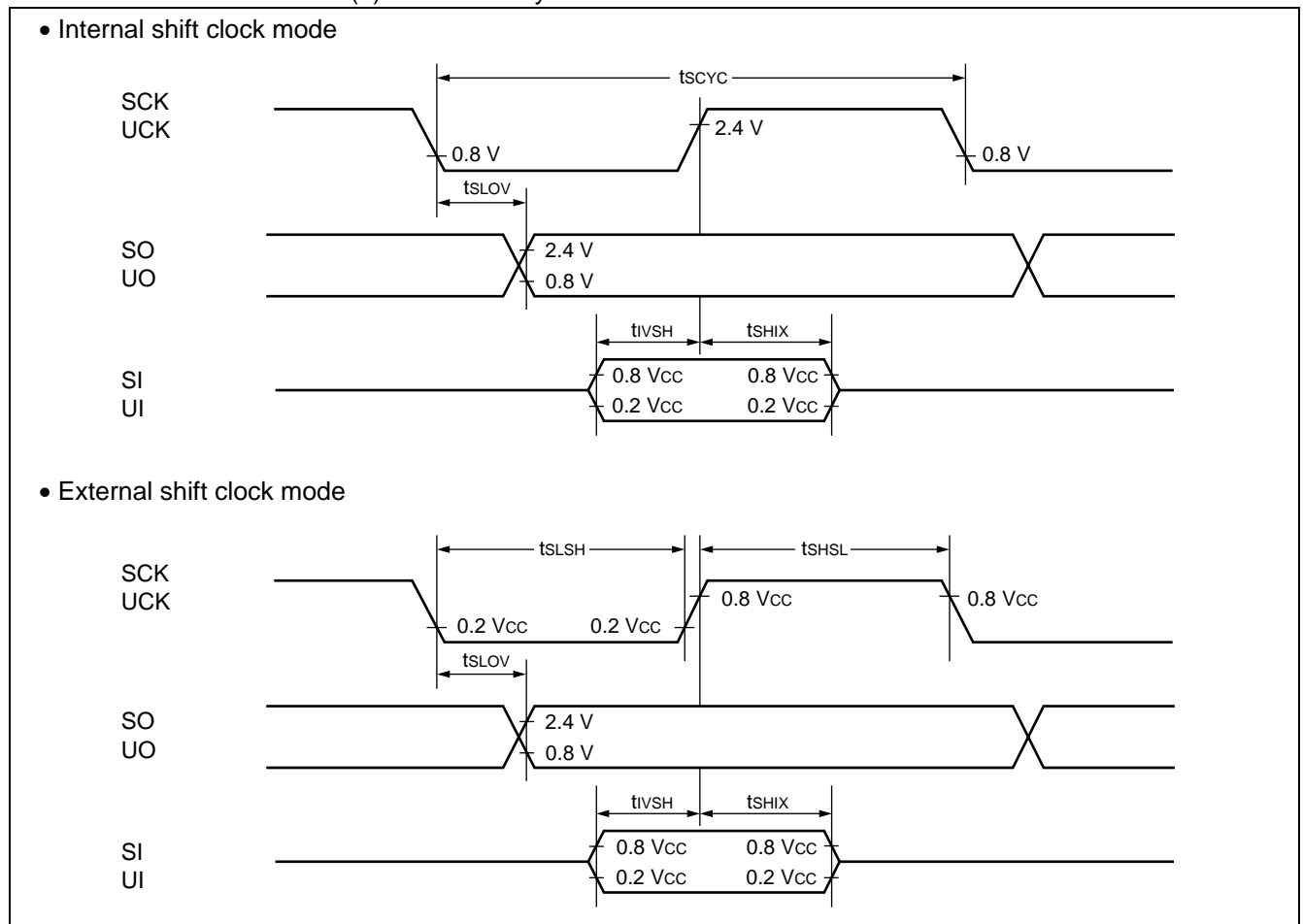

MB89550A Series

(7) Peripheral Input Timing

($V_{CC1} = 3\text{ V}$, $AV_{CC} = AVR = DVR = V_{CC2} = 5.0\text{ V}$, $AV_{SS} = V_{SS} = 0\text{ V}$, $T_A = -40\text{ }^{\circ}\text{C}$ to $+85\text{ }^{\circ}\text{C}$)

Parameter	Symbol	Pin Nme	Condition	Value		Unit	Remarks
				Min	Max		
Peripheral input "H" level pulse width 1	t_{LIH1}	EC1, EC2, EC3 $\overline{\text{INT10}}$ to $\overline{\text{INT17}}$	—	1 t_{inst}^*	—	μS	
Peripheral input "L" level pulse width 1	t_{HIL1}	EC1, EC2, EC3 $\overline{\text{INT10}}$ to $\overline{\text{INT17}}$	—	1 t_{inst}^*	—	μS	
Peripheral input "H" level pulse width 1	t_{LIH2}	PWC, $\overline{\text{INT20}}$ to $\overline{\text{INT27}}$	—	2 t_{inst}^*	—	μS	
Peripheral input "L" level pulse width 1	t_{HIL2}	PWC, $\overline{\text{INT20}}$ to $\overline{\text{INT27}}$	—	2 t_{inst}^*	—	μS	

* : For a definition of t_{inst} see " (5) Instruction Cycle".

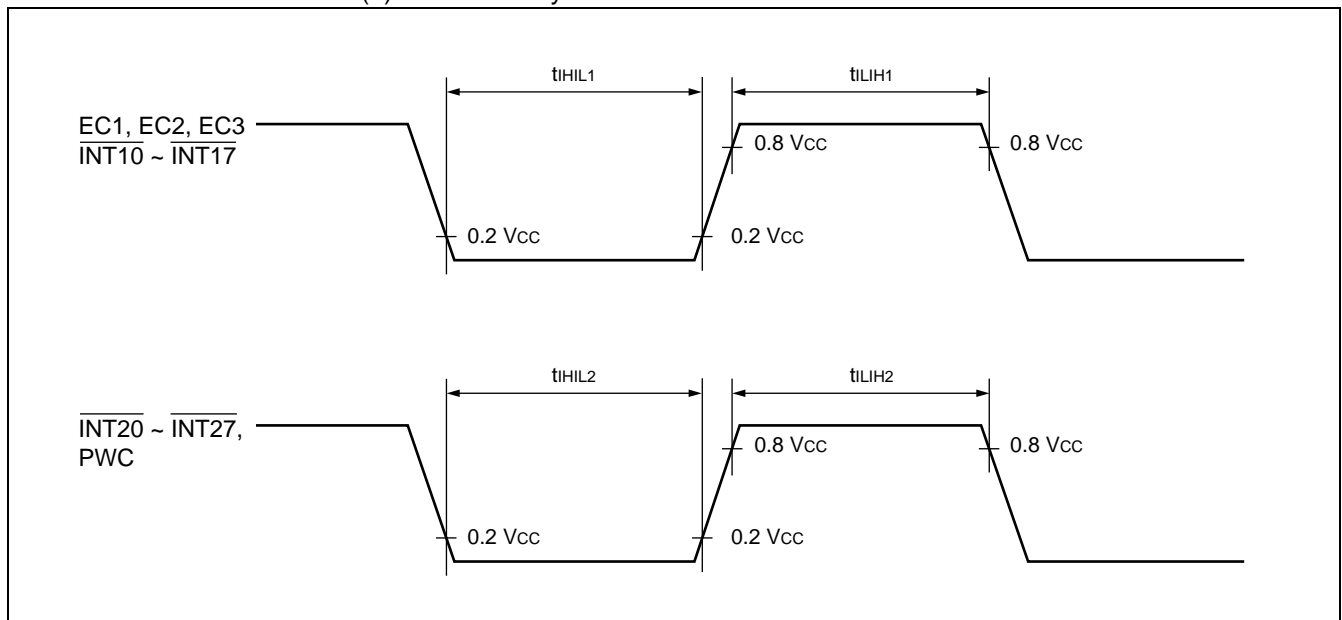

(8) Electrical Characteristics for the A/D Converter

($V_{CC1} = 3\text{ V}$, $AV_{CC} = AVR = DVR = V_{CC2} = 3.5\text{ V to }5.5\text{ V}$, $AV_{SS} = V_{SS} = 0\text{ V}$, $T_A = -40\text{ }^\circ\text{C to }+85\text{ }^\circ\text{C}$)

Item	Symbol	Pin Nme	Condition	Rating			Unit	Remarks
				Min	Typ	Max		
Resolution	—	—	—	—	10	—	bit	
Total error			AVR = AV _{CC}	—	—	±5.0	LSB	
Linearity error				—	—	±2.5	LSB	
Differential linearity error				—	—	±1.9	LSB	
Zero transition voltage	V _{OT}	AN0 to AN7		AV _{SS} - 3.5	+ 0.5	AV _{SS} + 4.5	LSB	
Full scale transition voltage	V _{FST}		AVR - 6.5	AVR - 1.5	AVR + 1.5	LSB		
Variation between channels	—		—	—	—	4	LSB	
Conversion time	—	—	—	—	60 t _{inst}	—	μs	*
Sampling time	—	—		—	16 t _{inst}	—	μs	
Analog input current	I _{AIN}	AN0 to AN7		—	—	10	μA	
Analog input voltage	V _{AIN}			AV _{SS}	—	AVR	V	
Reference voltage	—	AVR	AV _{SS} + 2.7	—	AV _{CC}	V		
Reference voltage supply current	I _R		A/D operating	—	400	—	μA	
	I _{RH}		A/D stop	—	—	5	μA	

* : Includes sampling time.

(9) Electrical Characteristics for the D/A Converter

($V_{CC1} = 3\text{ V}$, $AV_{CC} = AVR = DVR = V_{CC2} = 3.5\text{ V to }5.5\text{ V}$, $AV_{SS} = V_{SS} = 0\text{ V}$, $T_A = -40\text{ }^\circ\text{C to }+85\text{ }^\circ\text{C}$)

Item	Symbol	Pin Nme	Condition	Rating			Unit	Remarks
				Min	Typ	Max		
Resolution	—	—	—	—	8	—	bit	
Differential linearity error			AVR = AV _{CC}	—	—	±0.9	LSB	
Linearity error				—	—	±1.5	LSB	
Conversion time				—	10	20	μs	*1
Analog reference voltage	V _{SS} + 3.0	—		AV _{CC}	V			
Reference voltage supply current	I _{DVR}	DVR	D/A running	—	120	300	μA	*2
	I _{DVRS}		D/A off	—	—	10	μA	*3
Analog output impedance	—	—	—	—	20	—	kΩ	MB89P558A
				—	30	—	kΩ	MB89558A/557A

*1 : With load capacitance 20 pF.

*2 : No-load conversion

*3 : Stop mode

MB89550A Series

(10) A/D Converter Glossary

- Resolution
The level of analog variation that can be recognized by the A/D converter.
- Linearity error (Unit : LSB)
The deviation between the actual conversion characteristics and the line linking the zero transition point ("00 0000 0000" ↔ "00 0000 0001") and the full-scale transition point ("11 1111 1110" ↔ "11 1111 1111").
- Differential linearity error (Unit : LSB)
The variation from the theoretical input voltage required to change the output code by 1 LSB.
- Total error (Unit : LSB)
The total error is the difference between the actual value and the theoretical value.

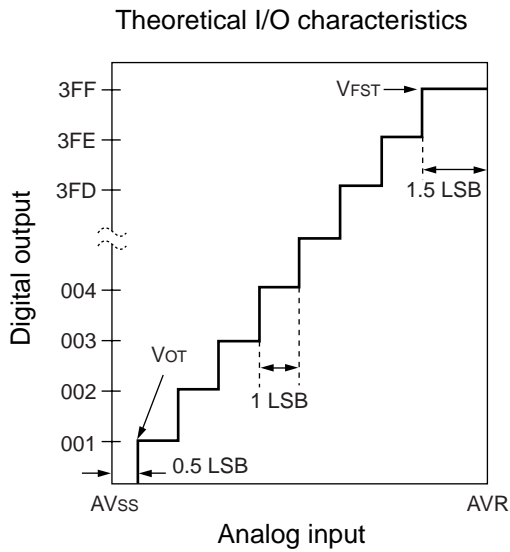

$$1 \text{ LSB} = \frac{V_{FST} - V_{OT}}{1022} \quad (\text{V})$$

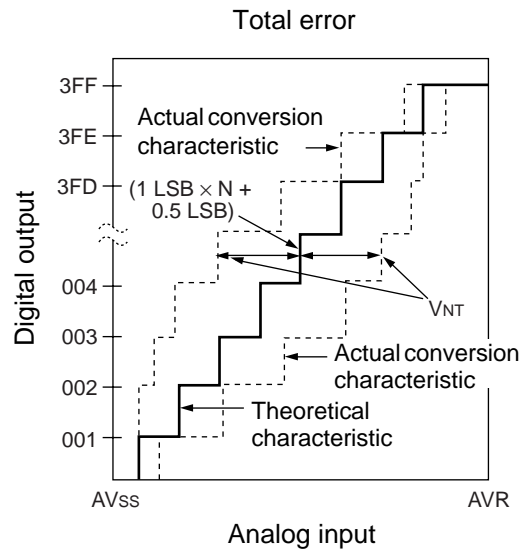

$$\text{Total error for digital output } N = \frac{V_{NT} - \{1 \text{ LSB} \times N + 0.5 \text{ LSB}\}}{1 \text{ LSB}}$$

(Continued)

(Continued)

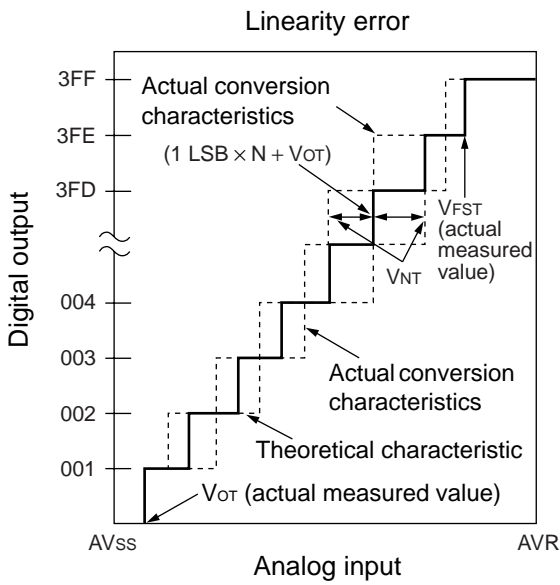
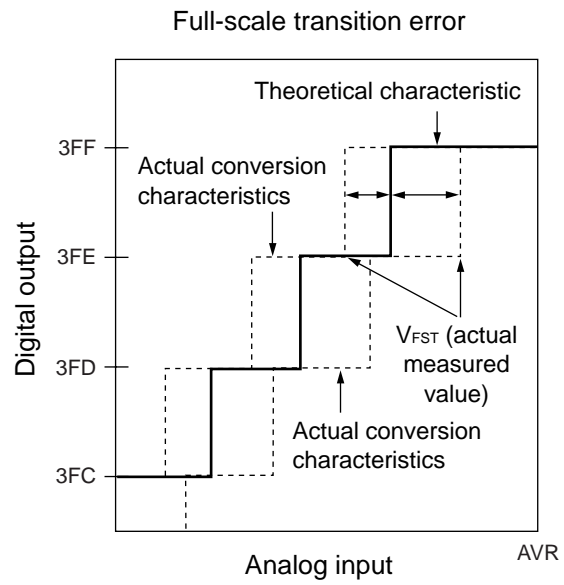
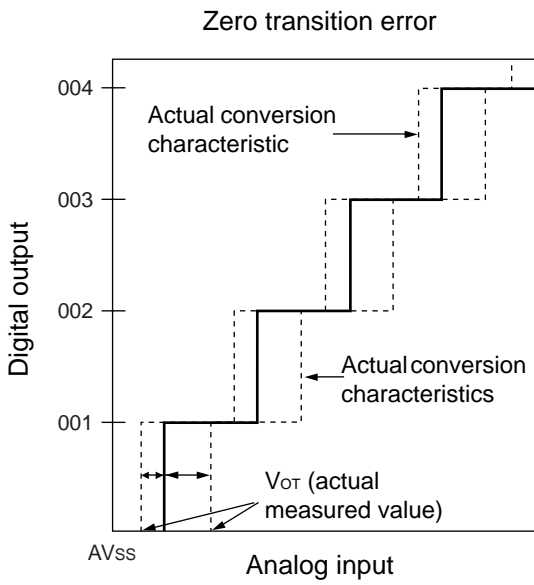

$$\text{Linearity error in digital output } N = \frac{V_{NT} - \{1 \text{ LSB} \times N + V_{OT}\}}{1 \text{ LSB}}$$

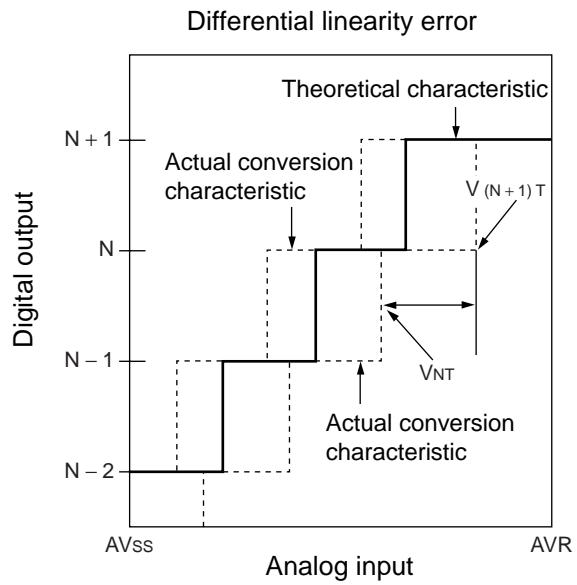

$$\text{Differential linearity error in digital output } N = \frac{V_{(N+1)T} - V_{NT}}{1 \text{ LSB}} - 1$$

MB89550A Series

(11) Notes for A/D Conversion

- Analog input pins and input impedance

The A/D converter in the MB89550A series incorporates a sample & hold circuit as shown below. When an A/D conversion starts, the voltage at the analog input pin is captured by the sample & hold capacitor for a period of 16 instruction cycles.

Accordingly, if the output impedance of the external circuit connected to the analog input is high, the analog input voltage may not stabilize within the period of the analog input sampling time. Therefore, it is recommended that the output impedance of the external circuit be sufficiently low (10 kΩ or less) .

- Equivalent circuit for MB89558A and MB89557A analog input

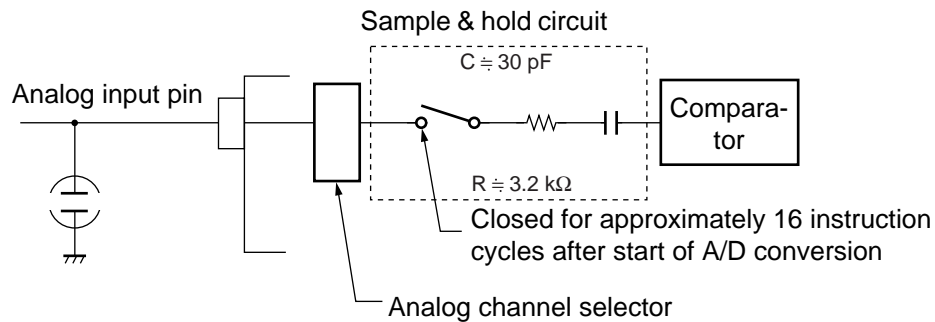

- Equivalent circuit for MB89P558A and MB89PV550A analog input

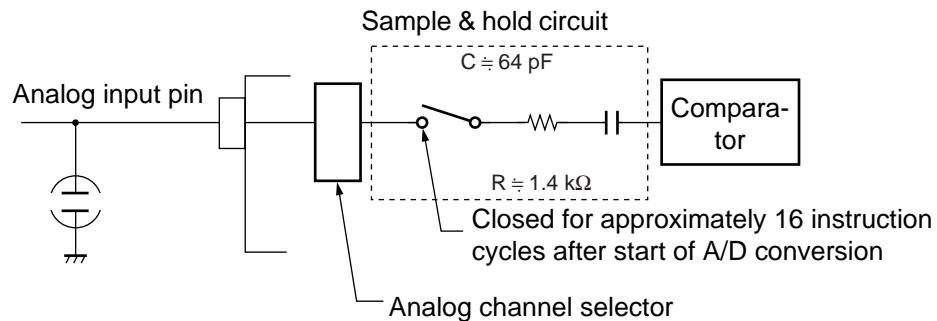

- Error

The relative error increases as $|AVR - AV_{SS}|$ becomes smaller.

EXAMPLE CHARACTERISTICS

(1) Power Supply Current (External Clock)

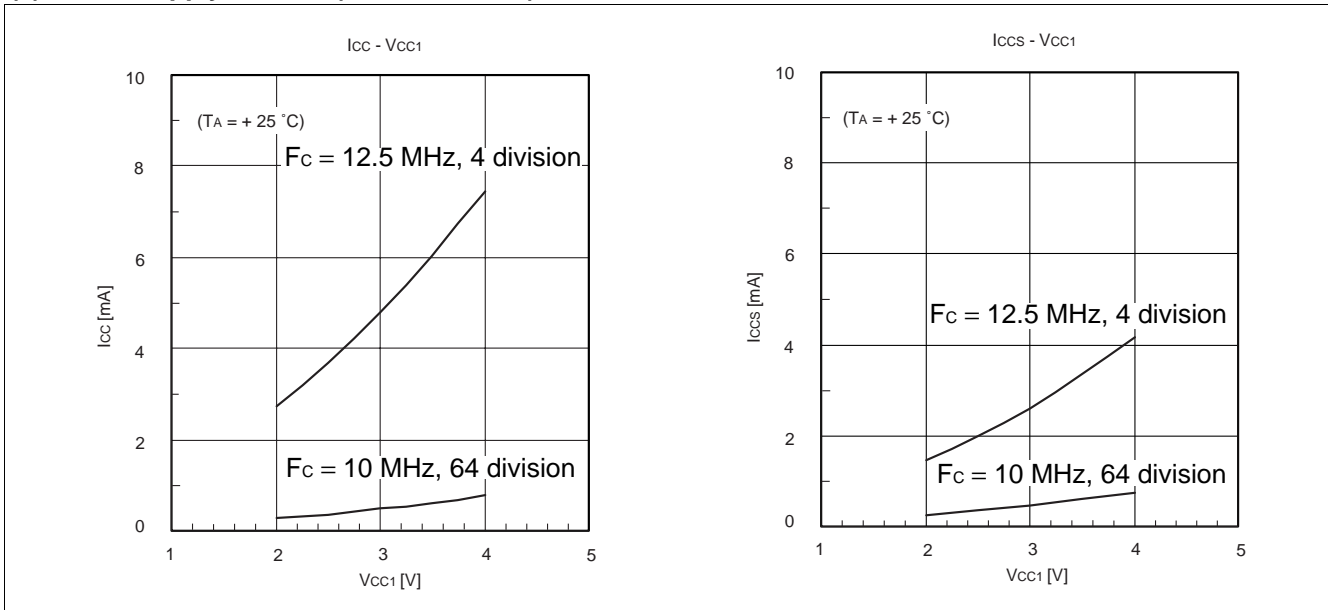

(2) “H” Level Input Voltage/“L” Level Input Voltage (CMOS Input)

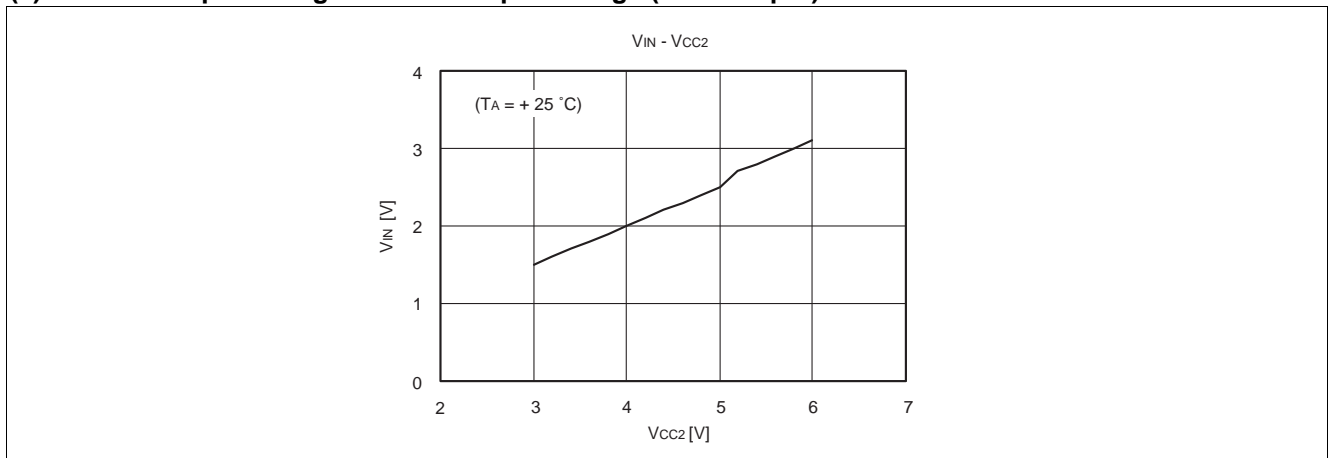

(3) “H” Level Input Voltage/“L” Level Input Voltage (Hysteresis Input)

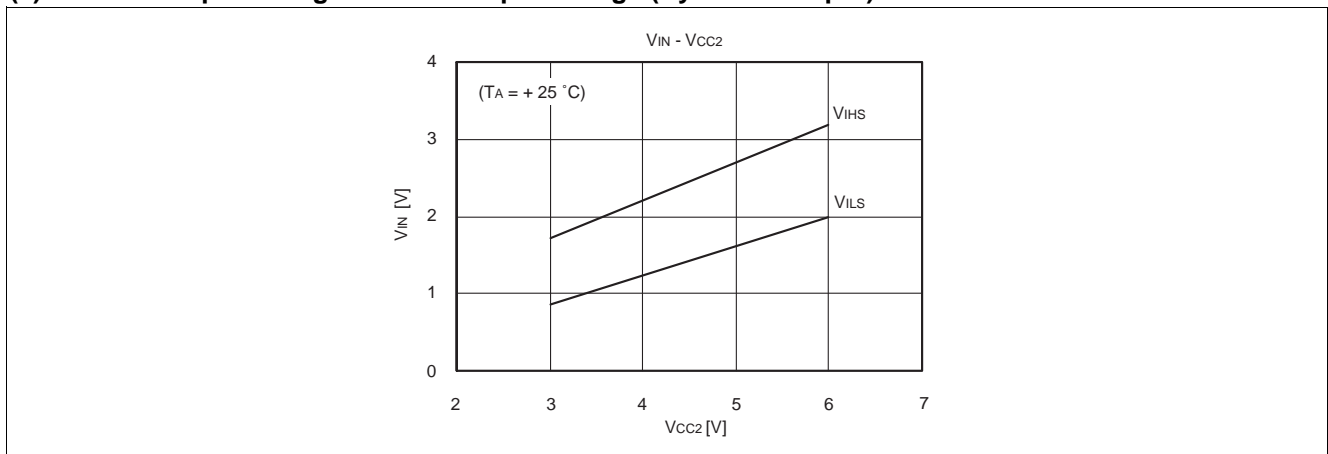

MB89550A Series

(4) Pull-up Resistance

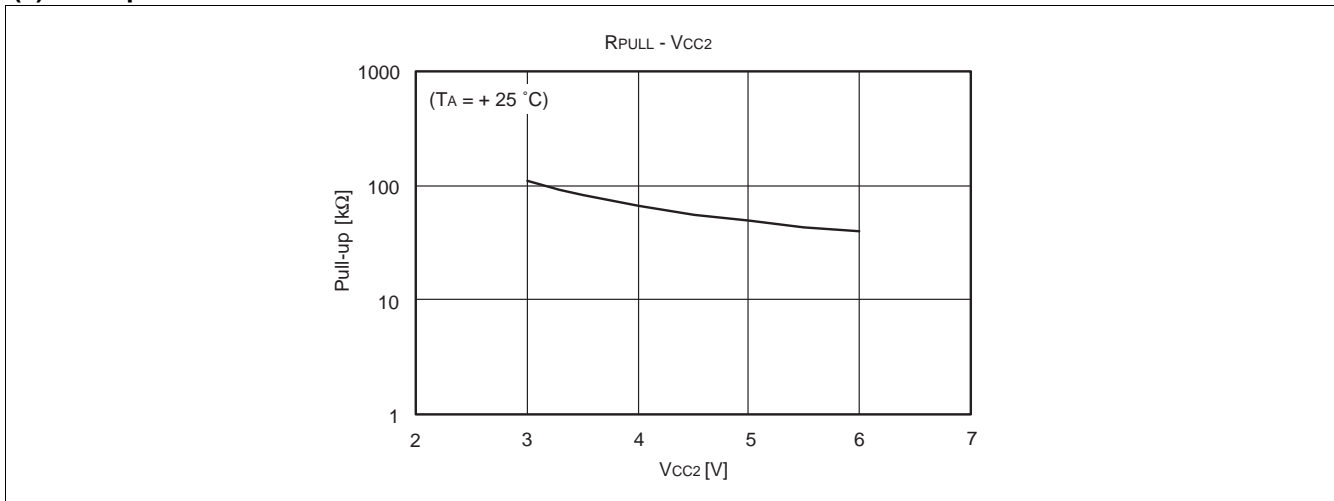

(5) "H" Level Output Voltage

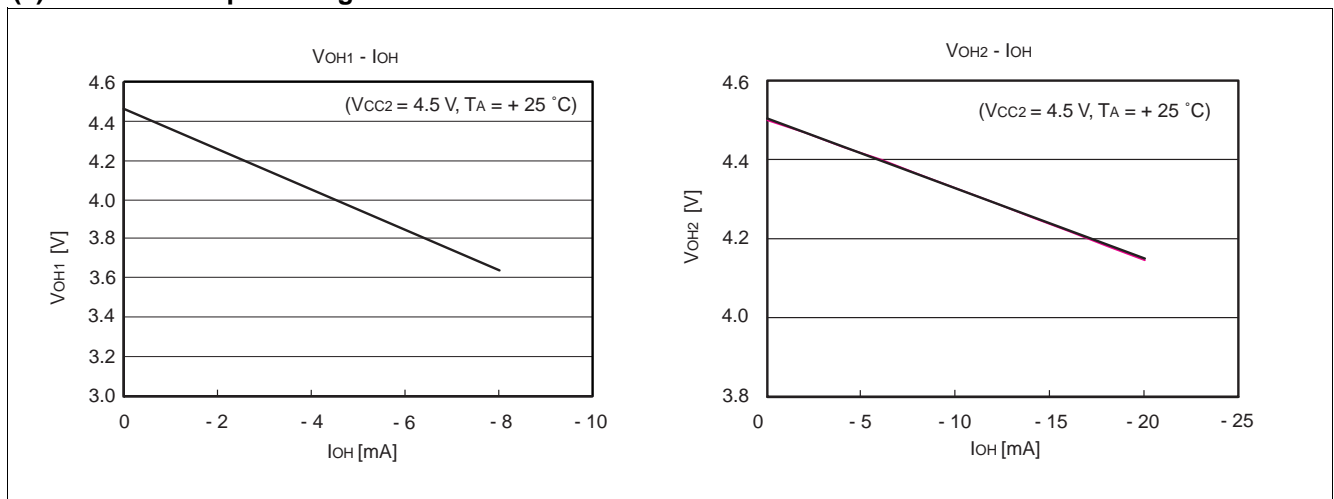

(6) "L" Level Output Voltage

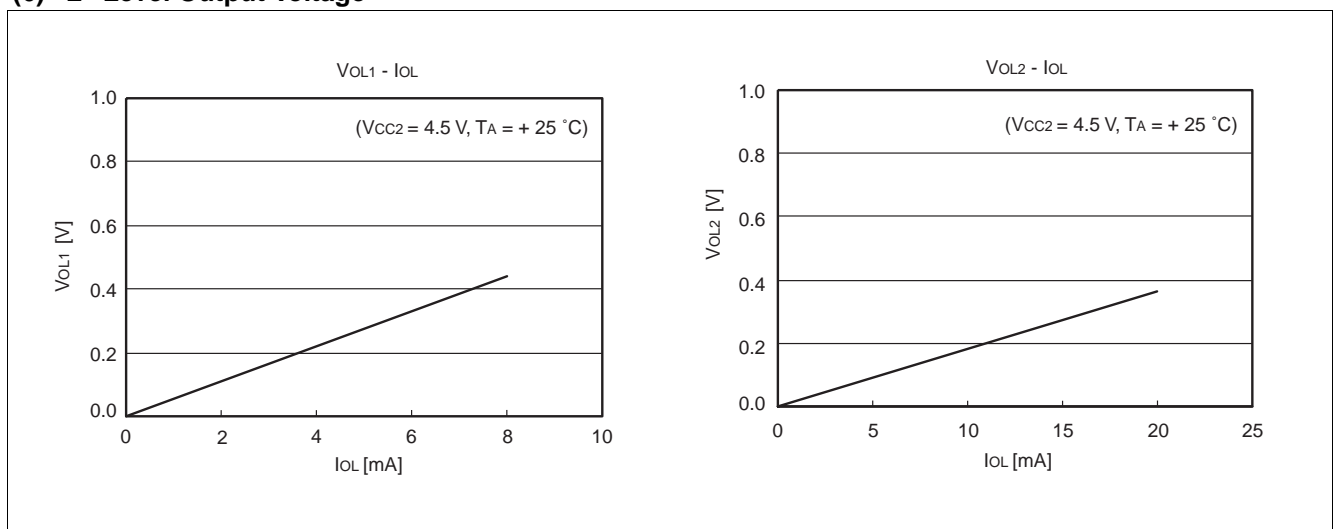

(7) A/D Converter Characteristic Example

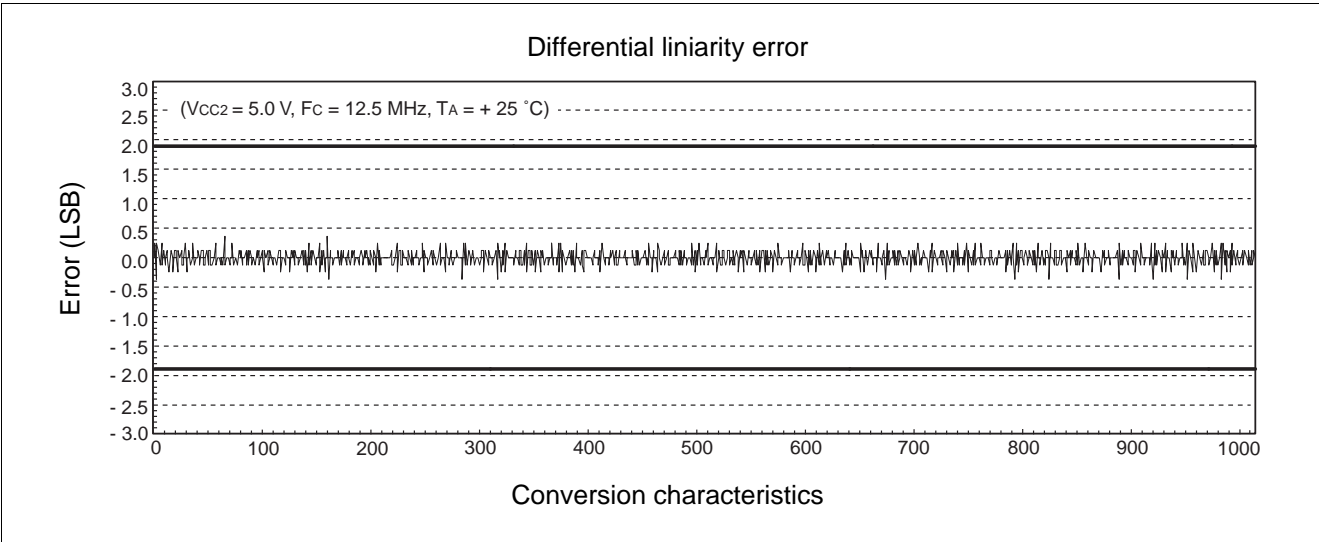
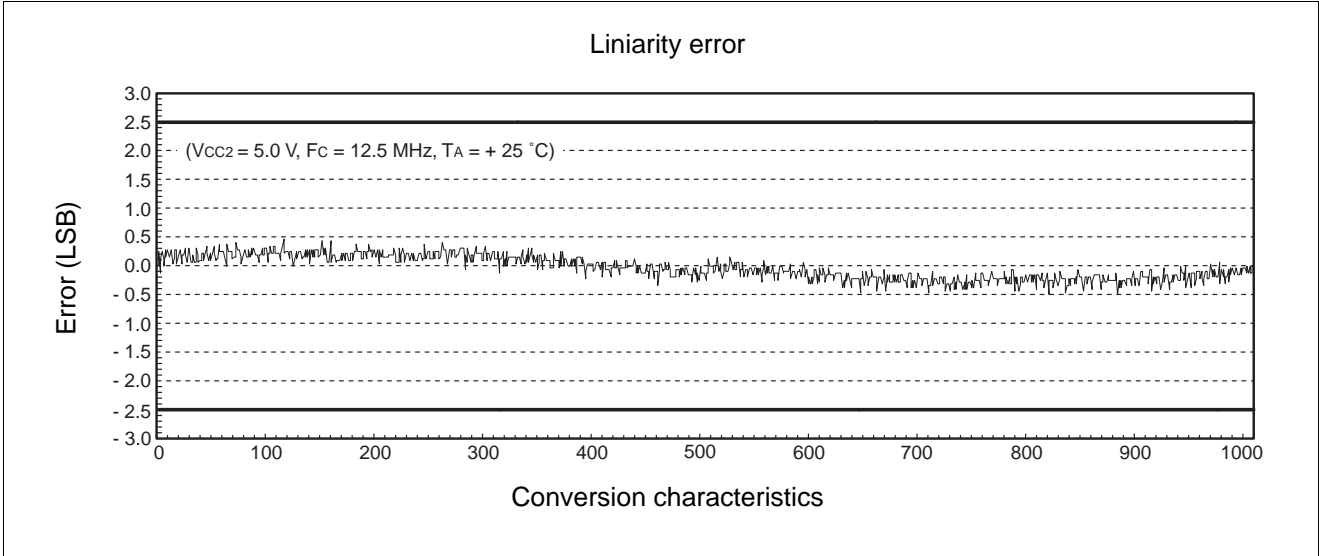

MB89550A Series

■ MASK OPTIONS

No.	Part No.	MB89557A MB89558A	MB89P558A	MB89PV550A
	Specifying procedure	Specify when ordering mask	Specify at time of order	Specify at time of order
1	LCD drive power supply <ul style="list-style-type: none"> • Built-in step-up circuit • Built-in multiplier resistance (for external connection) 	Selectable	-201 built-in multiplier resistance	-201 built-in multiplier resistance
			-202 built-in step-up circuit	-202 built-in step-up circuit
			-203 built-in step-up circuit	-203 built-in step-up circuit
2	Port/segment selection*1 P66 (SEG22), P67 (SEG23), P70 (SEG24), P71 (SEG25), P72 (SEG26), P73 (SEG27), P74 (SEG28), P75 (SEG29), P76 (SEG30), P77 (SEG31)	Selectable	-201 segment selected (SEG22-SEG31 selected)	-201 segment selected (SEG22-SEG31 selected)
			-202 segment selected (SEG22-SEG31 selected)	-202 segment selected (SEG22-SEG31 selected)
			-203 port selected (P66, P67, P70-P77 selected)	-203 port selected (P66, P67, P70-P77 selected)
3	Main clock Initial value*2 selection for oscillator stabilization wait period (Fch = 12.5 MHz) <ul style="list-style-type: none"> • 01 : $2^{14}/F_{ch}$ (approx. 1.31 ms) • 10 : $2^{17}/F_{ch}$ (approx. 10.48 ms) • 11 : $2^{18}/F_{ch}$ (approx. 20.97 ms) 	Selectable	$2^{18}/F_{ch}$ (approx. 20.97 ms)	$2^{18}/F_{ch}$ (approx. 20.97 ms)

*1 : This selection determines whether pins P66, P67, P70-P77 are used as I/O ports or as segment output pins. If they are used as ports, then SEG22-SEG31 (Nch open drain) are not restricted by the condition for input voltage to pins (V_{IN}), namely that " V_{IN} must be lower than the voltage at the V3 pin".

*2 : This represents the initial value of the oscillator stabilization period select bit (SYCC : WT1, WT0) of the system clock control register.

MB89550A Series

■ ORDERING INFORMATION

Part No.	Package	Remarks
MB89558APFV-XXX	100-pin Plastic LQFP (FPT-100P-M05)	
MB89558APFT-XXX	100-pin Plastic TQFP (FPT-100P-M18)	
MB89P558A-201PFV versions without step-up MB89P558A-202PFV with step-up 32 Segment MB89P558A-203PFV with step-up 22 Segment	100-pin Plastic LQFP (FPT-100P-M05)	
MB89P558A-201PFT versions without step-up MB89P558A-202PFT with step-up 32 Segment MB89P558A-203PFT with step-up 22 Segment	100-pin Plastic TQFP (FPT-100P-M18)	
MB89PV550A-201CF versions without step-up MB89PV550A-202CF with step-up 32Segment MB89PV550A-203CF with step-up 22Segment	100-pin Ceramic MQFP (MQP-100C-P02)	

MB89550A Series

PACKAGE DIMENSIONS

100-pin plastic LQFP
(FPT-100P-M05)

Note) Pins width and pins thickness include plating thickness.

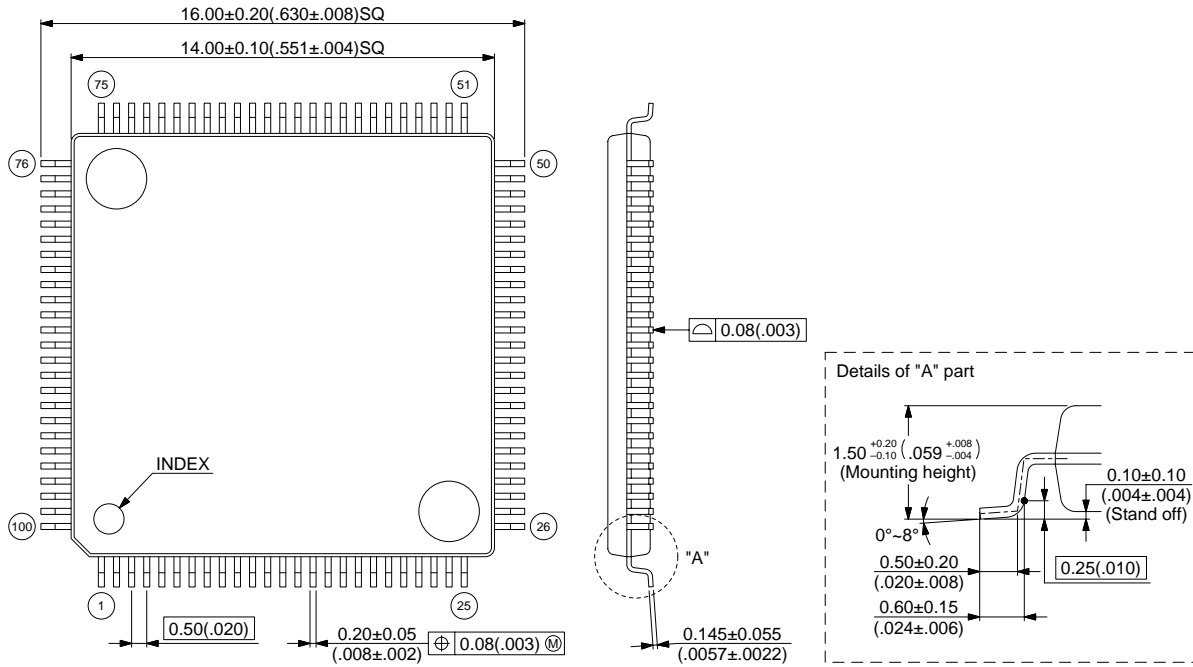

© 2000 FUJITSU LIMITED F100007S-3c-5

Dimensions in mm (inches)

(Continued)

MB89550A Series

100-pin plastic TQFP
(FPT-100P-M18)

Note) Pins width and pins thickness include plating thickness.

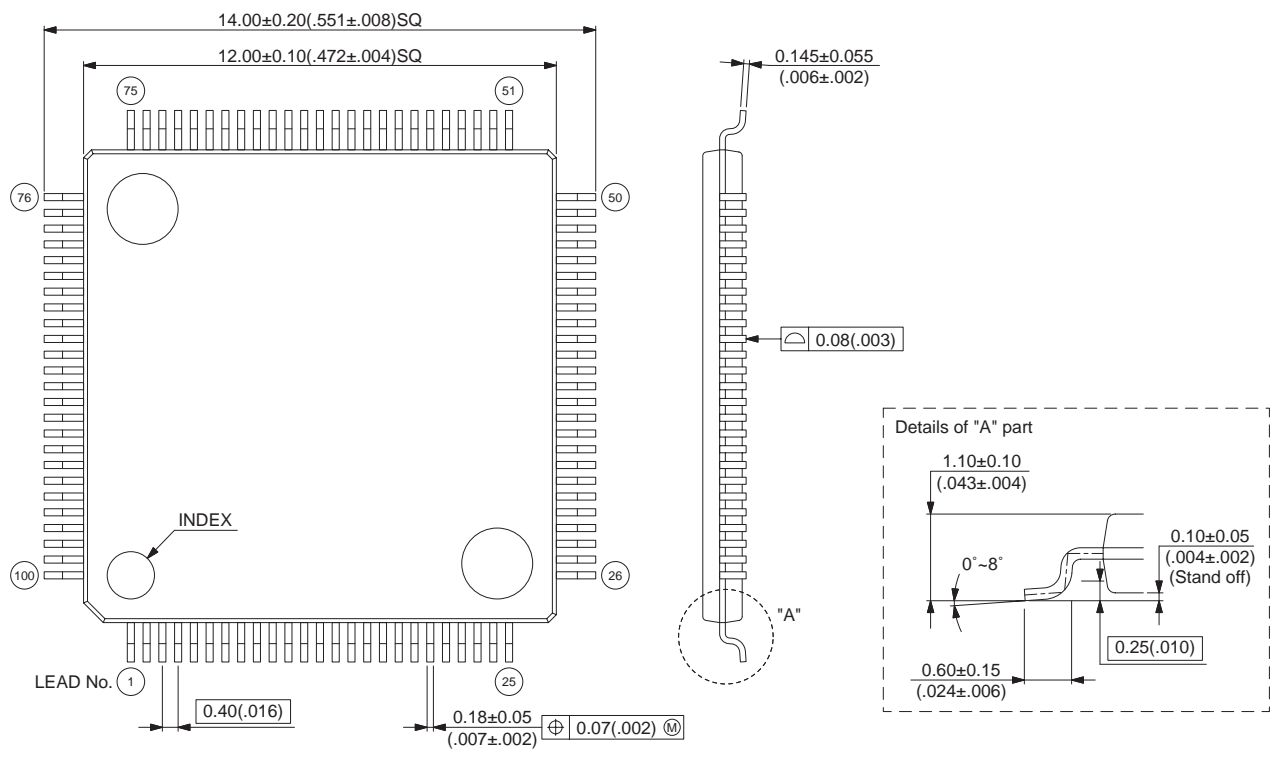

© 2000 FUJITSU LIMITED F100029S-c-2-3

Dimensions in mm (inches)

(Continued)

MB89550A Series

(Continued)

100-pin Ceramic MQFP
(MQP-100C-P02)

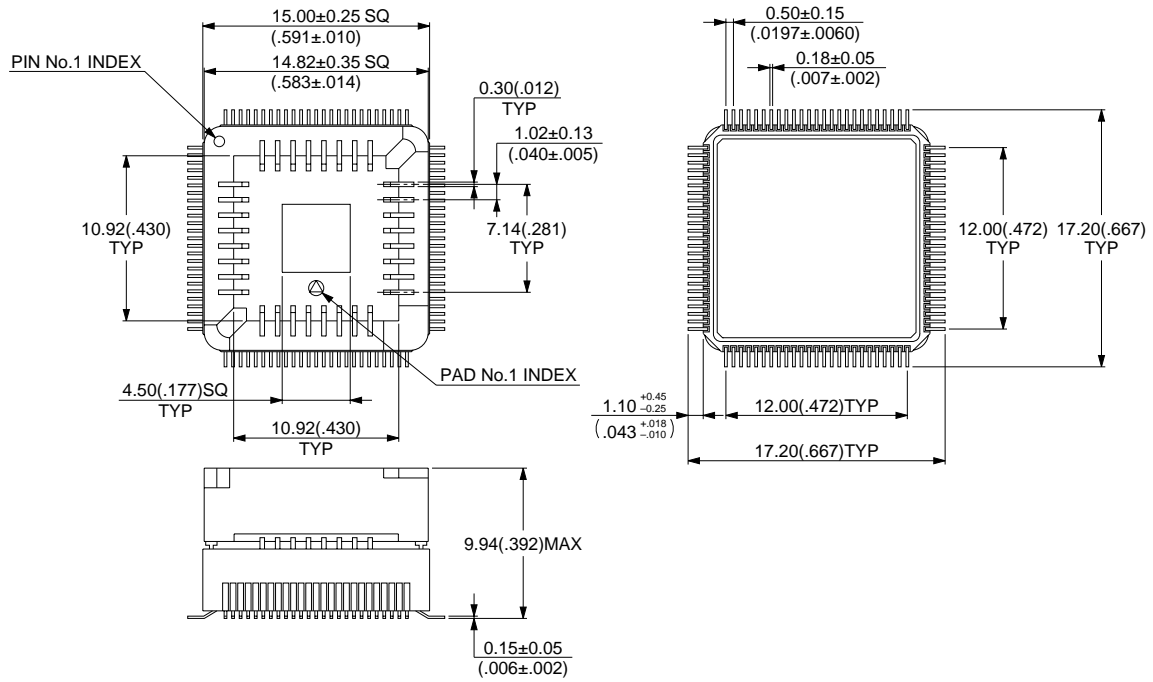

© 1994 FUJITSU LIMITED M100002SC-2-2

Dimensions in mm (inches)

FUJITSU LIMITED

All Rights Reserved.

The contents of this document are subject to change without notice. Customers are advised to consult with FUJITSU sales representatives before ordering.

The information and circuit diagrams in this document are presented as examples of semiconductor device applications, and are not intended to be incorporated in devices for actual use. Also, FUJITSU is unable to assume responsibility for infringement of any patent rights or other rights of third parties arising from the use of this information or circuit diagrams.

The products described in this document are designed, developed and manufactured as contemplated for general use, including without limitation, ordinary industrial use, general office use, personal use, and household use, but are not designed, developed and manufactured as contemplated (1) for use accompanying fatal risks or dangers that, unless extremely high safety is secured, could have a serious effect to the public, and could lead directly to death, personal injury, severe physical damage or other loss (i.e., nuclear reaction control in nuclear facility, aircraft flight control, air traffic control, mass transport control, medical life support system, missile launch control in weapon system), or (2) for use requiring extremely high reliability (i.e., submersible repeater and artificial satellite).

Please note that Fujitsu will not be liable against you and/or any third party for any claims or damages arising in connection with above-mentioned uses of the products.

Any semiconductor devices have an inherent chance of failure. You must protect against injury, damage or loss from such failures by incorporating safety design measures into your facility and equipment such as redundancy, fire protection, and prevention of over-current levels and other abnormal operating conditions.

If any products described in this document represent goods or technologies subject to certain restrictions on export under the Foreign Exchange and Foreign Trade Law of Japan, the prior authorization by Japanese government will be required for export of those products from Japan.