



# SPE1225

## 5-Line ESD Protection Array

### DESCRIPTION

The SPE1225 are designed by TVS array that is to protect sensitive electronics from damage or latch-up due to ESD. They are designed for use in applications where board space is at a premium. SPE1225 will protect up to five lines, and may be used on lines where the signal polarities swing above and below ground.

SPE1225 offer desirable characteristics for board level protection including fast response time, low operating and clamping voltage, and no device degradation.

SPE1225 may be used to meet the immunity requirements of IEC 61000-4-2, level 4. The small SOT-363 package makes them ideal for use in portable electronics such as cell phones, PDA's, notebook computers, and digital cameras.

### APPLICATIONS

- ◆ Cellular Handsets and Accessories
- ◆ Cordless Phone
- ◆ PDA
- ◆ Notebooks and Handhelds
- ◆ Portable Instrumentation
- ◆ Digital Cameras
- ◆ MP3 Player

### FEATURES

- ◆ Transient protection for data lines to IEC 61000-4-2 (ESD)  $\pm 15\text{kV}$  (air),  $\pm 8\text{kV}$  (contact)
- ◆ IEC 61000-4-4 (EFT) 40A (5/50ns)
- ◆ Protects five I/O lines
- ◆ Working voltage: 12V
- ◆ Low leakage current
- ◆ Low operating and clamping voltages

### PIN CONFIGURATION ( SOT-363 / SC-70 )

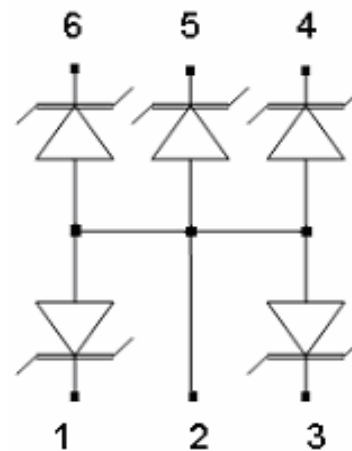

### PART MARKING



**Y : Year Code**  
**W : Week Code**



# SPE1225

## 5-Line ESD Protection Array

### ORDERING INFORMATION

Part Number	Package	Part Marking
SPE1225S36RG	SOT-363	E5YW

※ Week Code : A ~ Z ( 1 ~ 26 ) ; a ~ z ( 27 ~ 52 )

※ SPE1225S36RG : Tape Reel ; Pb – Free

### ABSOLUTE MAXIMUM RATINGS

(TA=25°C Unless otherwise noted)

Parameter	Symbol	Typical	Unit
Peak Pulse Power ( tp = 8/20 μs )	Ppk	250	W
Maximum Peak Pulse Current ( tp = 8/20 μs )	Ipp	8	A
ESD per ICE 61000 – 4 – 2 (Air )	Vpp	±15	KV
ESD per ICE 61000 – 4 – 2 (Contact )	Vpp	±8	KV
Operating Junction Temperature	Tj	-55 ~ 150	°C
Storage Temperature Range	TSTG	-55 ~ 150	°C
Lead Soldering Temperature	TL	260 ( 10sec )	°C

### ELECTRICAL CHARACTERISTICS

(TA=25°C Unless otherwise noted)

Parameter	Symbol	Conditions	Min.	Typ	Max.	Unit
Reverse Stand – Off Voltage	VRWM				12	V
Reverse Breakdown Voltage	VBR	It = 1mA	13.3			V
Reverse Leakage Current	IR	VRWM = 12V , T=25°C			1	μA
Clamping Voltage	Vc	Ipp = 1A , tp = 8/20 μs			19	V
Clamping Voltage	Vc	Ipp = 8A , tp = 8/20 μs			25	V
Junction Capacitance	Cj	Between I/O Pin and GND VR = 0V , f = 1MHz		16	20	pF



# SPE1225 5-Line ESD Protection Array

## TYPICAL CHARACTERISTICS

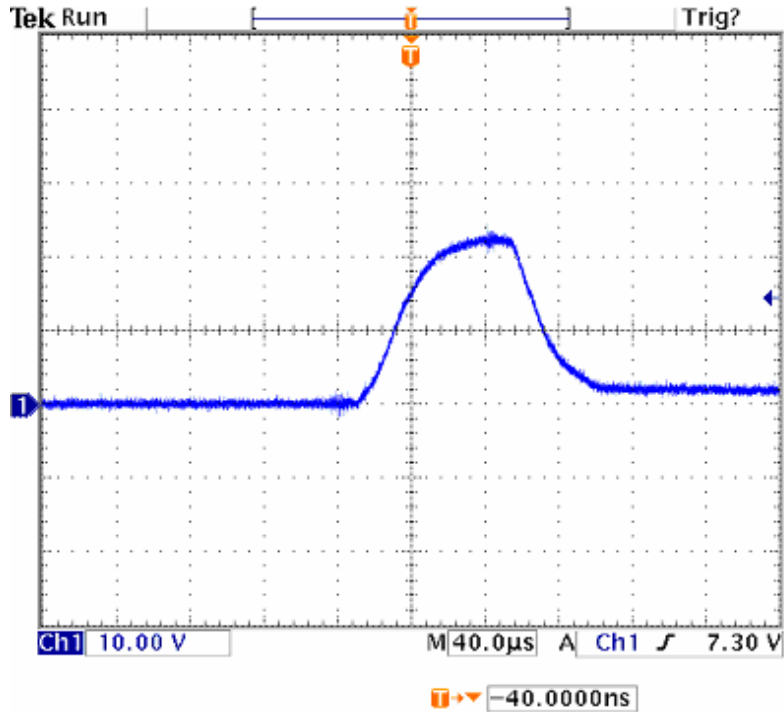

Clamping Voltage ( $I_{pp} = 1A$ ,  $t_p = 8/20 \mu s$ )

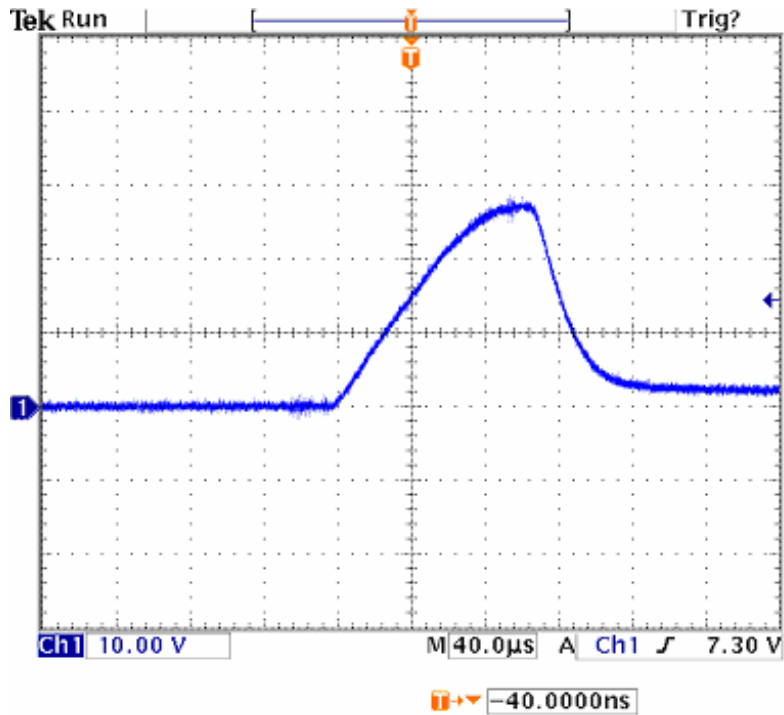

Clamping Voltage ( $I_{pp} = 8A$ ,  $t_p = 8/20 \mu s$ )



# SPE1225 5-Line ESD Protection Array

## TYPICAL CHARACTERISTICS

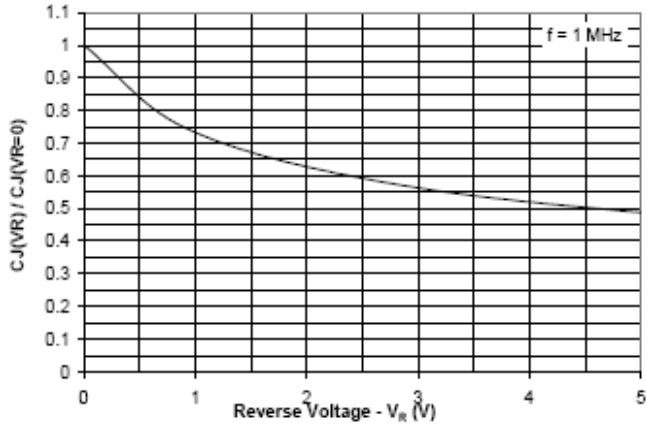

Fig 1 : Junction Capacitance V.S Reverse Voltage Applied

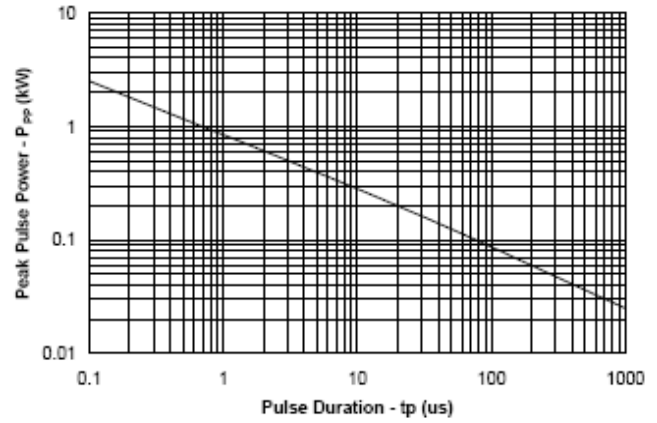

Fig 2 : Peak Plus Power V.S Exponential Plus Duration

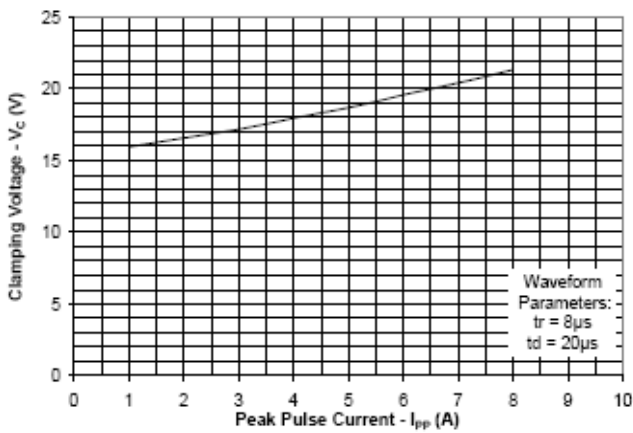

Fig 3 : Clamp Voltage V.S Peak Pulse Current

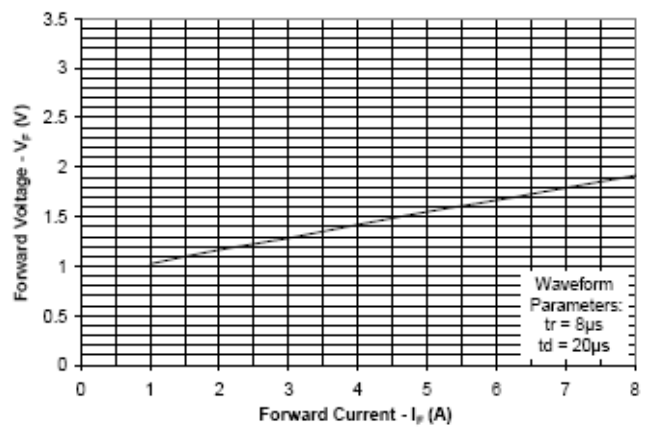

Fig 4 : Forward Voltage Drop V.S Peak Forward



# SPE1225

## 5-Line ESD Protection Array

### APPLICATION NOTE

#### Device Connection for Protection of Five Data Lines

SPE1225 is designed to protect up to five data lines. The device is connected as follows:

1. The TVS protection of five I/O lines is achieved by connecting pins 1, 3, 4, 5, and 6 to the data lines. Pin 2 is connected to ground. The ground connection should be made directly to the ground plane for best results. The path length is kept as short as possible to reduce the effects of parasitic inductance.

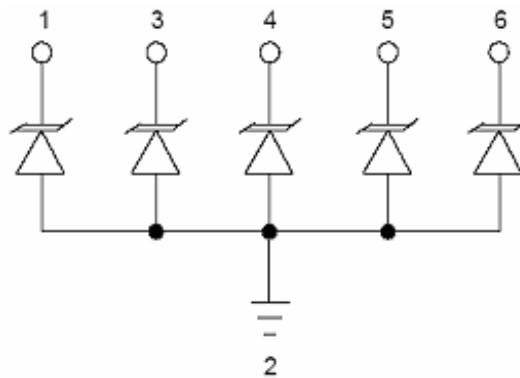

#### Circuit Board Layout Recommendations for Suppression of ESD

Good circuit board layout is critical for the suppression of ESD induced transients. The following guidelines are recommended:

1. Place the TVS near the input terminals or connectors to restrict transient coupling.
2. Minimize the path length between the TVS and the protected line.
3. Minimize all conductive loops including power and ground loops.
4. The ESD transient return path to ground should be kept as short as possible.
5. Never run critical signals near board edges.
6. Use ground planes whenever possible.

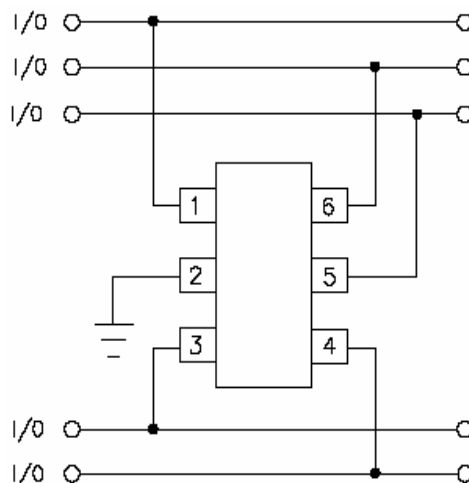



# SPE1225

## 5-Line ESD Protection Array

### SOT-363 PACKAGE OUTLINE

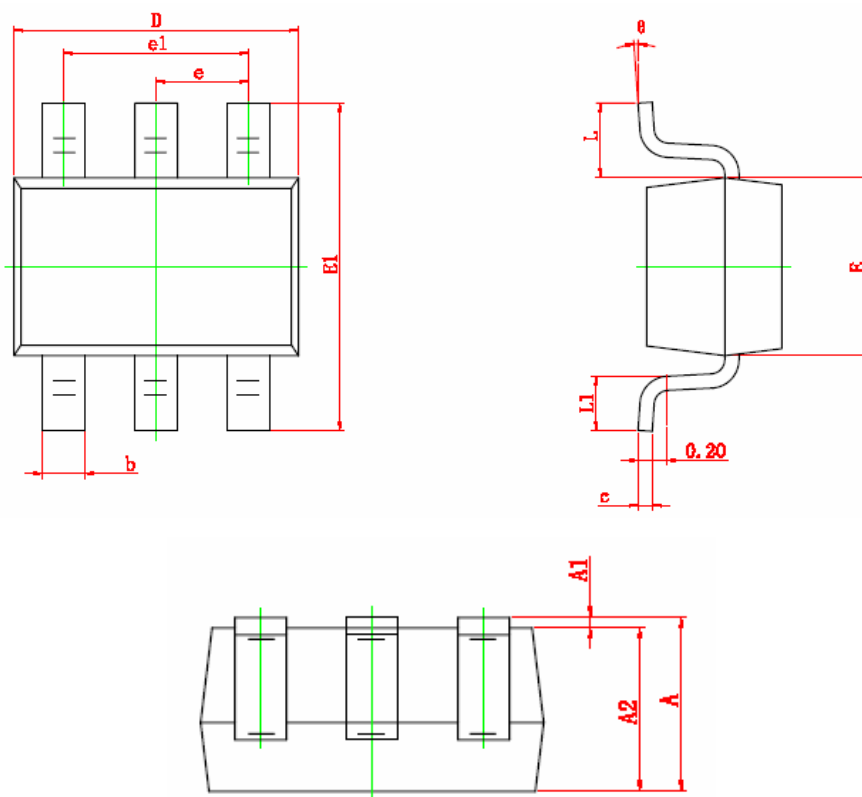

Symbol	Dimensions In Millimeters		Dimensions In Inches	
	Min	Max	Min	Max
A	0.900	1.100	0.035	0.043
A1	0.000	0.100	0.000	0.004
A2	0.900	1.000	0.035	0.039
b	0.150	0.350	0.006	0.014
c	0.080	0.150	0.003	0.006
D	2.000	2.200	0.079	0.087
E	1.150	1.350	0.045	0.053
E1	2.150	2.450	0.085	0.096
e	0.650 TYP		0.026 TYP	
e1	1.200	1.400	0.047	0.055
L	0.525 REF		0.021 REF	
L1	0.260	0.460	0.010	0.018
θ	0°	8°	0°	8°



# SPE1225

## 5-Line ESD Protection Array

---

Information provided is alleged to be exact and consistent. SYNC Power Corporation presumes no responsibility for the penalties of use of such information or for any violation of patents or other rights of third parties which may result from its use. No license is granted by allegation or otherwise under any patent or patent rights of SYNC Power Corporation. Conditions mentioned in this publication are subject to change without notice. This publication surpasses and replaces all information previously supplied. SYNC Power Corporation products are not authorized for use as critical components in life support devices or systems without express written approval of SYNC Power Corporation.

©The SYNC Power logo is a registered trademark of SYNC Power Corporation

©2004 SYNC Power Corporation – Printed in Taiwan – All Rights Reserved

SYNC Power Corporation

7F-2, No.3-1, Park Street

NanKang District (NKSP), Taipei, Taiwan, 115, R.O.C

Phone: 886-2-2655-8178

Fax: 886-2-2655-8468

©<http://www.syncpower.com>