

PLEASE CHECK WWW.MOLEX.COM FOR LATEST PART INFORMATION

Part Number: [0877592264](#)
Status: **Active**
Overview: milligrid
Description: 2.00mm (.079") Pitch Milli-Grid™ Header, Surface Mount, Vertical, 22 Circuits, 0.38µm (15µ") Gold (Au) Selective Plating, without Press-fit Plastic Pegs, Pick-and-Place Cap, Tube Packaging, Lead-free

Documents:

[3D Model](#) [Product Specification PS-87761-100 \(PDF\)](#)
[Drawing \(PDF\)](#) [RoHS Certificate of Compliance \(PDF\)](#)

Agency Certification

UL E29179

General

Product Family PCB Headers
 Series [87759](#)
 Application Board-to-Board
 Overview [milligrid](#)
 Product Name Milli-Grid™

Physical

Breakaway Yes
 Circuits (Loaded) 22
 Circuits (maximum) 22
 Color - Resin Black
 Durability (mating cycles max) 100
 First Mate / Last Break No
 Flammability 94V-0
 Glow-Wire Compliant No
 Guide to Mating Part No
 Keying to Mating Part None
 Lock to Mating Part None
 Mated Height (in) 0.150 In
 Mated Height (mm) 3.80 mm
 Material - Metal Phosphor Bronze
 Material - Plating Mating Gold
 Material - Plating Termination Tin
 Material - Resin Nylon
 Number of Rows 2
 Orientation Vertical
 PCB Locator No
 PCB Retention None
 Packaging Type Tube
 Pitch - Mating Interface (in) 0.079 In
 Pitch - Mating Interface (mm) 2.00 mm
 Pitch - Term. Interface (in) 0.079 In
 Pitch - Term. Interface (mm) 2.00 mm
 Plating min: Mating (µin) 15
 Plating min: Mating (µm) 0.38
 Polarized to Mating Part No
 Polarized to PCB No
 Robotic Placement Pick and Place Cap
 Shrouded No
 Stackable No
 Temperature Range - Operating -55°C to +105°C

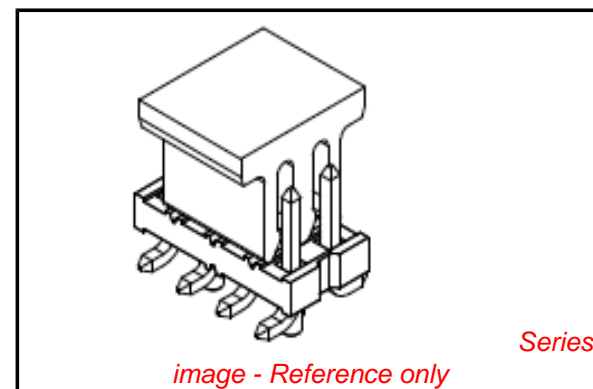

image - Reference only

EU RoHS

ELV and RoHS Compliant
REACH SVHC Contains SVHC: No
Halogen-Free Status
Not Reviewed

China RoHS



Need more information on product environmental compliance?

Email productcompliance@molex.com
 For a multiple part number RoHS Certificate of Compliance, [click here](#)

Please visit the [Contact Us](#) section for any non-product compliance questions.

Search Parts in this Series

[87759Series](#)

Mates With

[79107](#) Milli-Grid™ Receptacle, Vertical, Through Hole. [79108](#) Milli-Grid™ Flex-to-Board, Vertical Receptacle. Milli-Grid™ Receptacle, Surface Mount. [79109](#). [87381](#)

Termination Interface: Style Surface Mount

Electrical

Current - Maximum per Contact 2A
Voltage - Maximum 125V

Material Info

Reference - Drawing Numbers

Packaging Specification PK-89990-476
Product Specification PS-87761-100
Sales Drawing SD-87759-117

This document was generated on 05/25/2010

PLEASE CHECK WWW.MOLEX.COM FOR LATEST PART INFORMATION

F

E

D

C

B

A

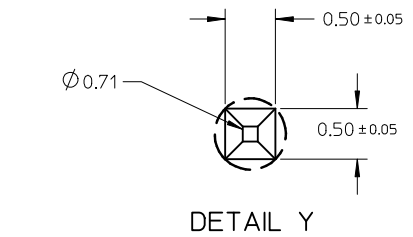
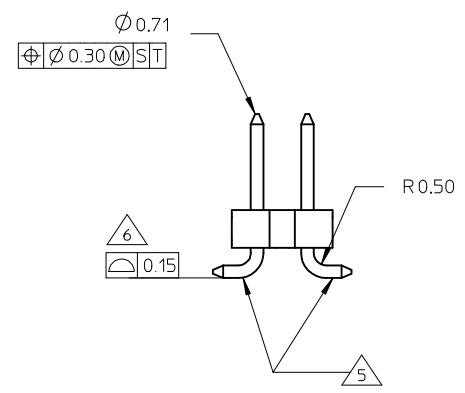
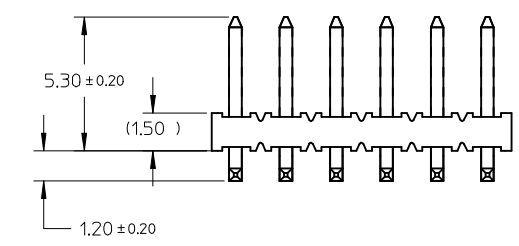
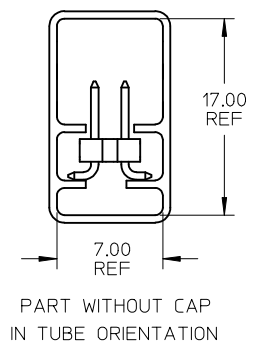
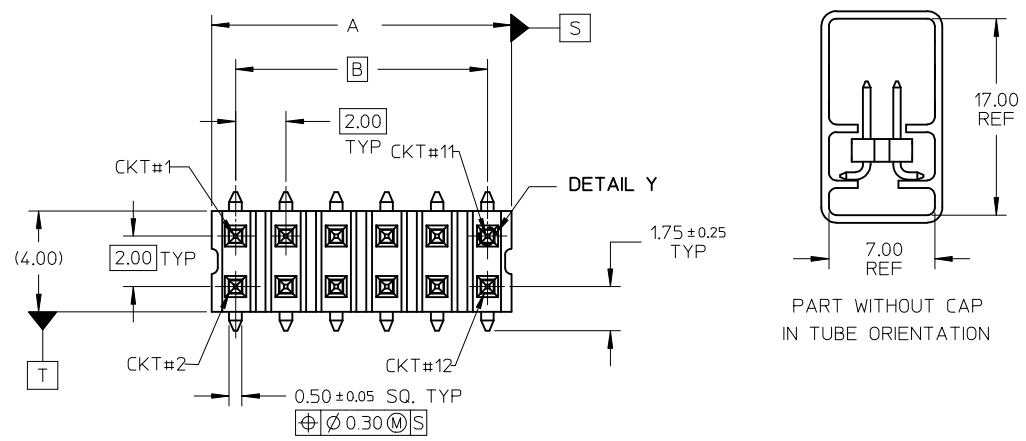

- NOTE:
- MATERIAL:
HSG & CAP - NYLON, GLASS FILLED
UL 94V-0, COLOUR BLACK

PIN - 0.50 SQ PHOSPHOR BRONZE
 - PLATING:
0.38um MIN GOLD PLATE AT CONTACT AREA,
TIN PLATE AT SOLDER AREA,
BOTH OVER NICKEL UNDERPLATE
 - PIN PUSHOUT FORCE: 1KG MIN IN EITHER DIRECTION
 - PRODUCT SPEC PS-87761-100 APPLIES.
 - BEND DEPRESSION IS ACCEPTABLE SO LONG AS IT DOES NOT AFFECT THE OVERALL COPLANARITY OF TAIL.
 - COPLANARITY IS TO BE MEASURED BY RESTING THE SOLDER TAIL ON A FLAT SURFACE.
 - CAP TO BE LOCATED AS CENTRAL OF PART AS POSSIBLE
TOP SURFACE OF CAP TO BE FLAT FOR THE PURPOSE OF PICK & PLACE BY VACUUM SUCTION NOZZLE.
 - FOR ILLUSTRATION PURPOSES, 12CKT IS SHOWN.
 - CKT 4 & 6 IS CUT FROM CKT 8 & 12 RESPECTIVELY
ROUGH EDGES ARE EXPECTED ALONG THE CUTTING EDGES.
 - PART TO BE PACKED IN TRAY ONLY.
 - TUBE LENGTH IS 560MM REF STANDARD.

ADD. OPTION EC NO: S2009-0510 DRWN:ATSEE 2009/01/23 CHKD:SKANG 2009/02/09 APPR:MLONG 2009/02/17	QUALITY SYMBOLS ▽=0 ◻=0	GENERAL TOLERANCES (UNLESS SPECIFIED)		DIMENSION STYLE MM ONLY	SCALE NTS	DESIGN UNITS METRIC	THIRD ANGLE PROJECTION		
		mm INCH	DRAWN BY KSEE	DATE 2003/12/12	TITLE CUSTOM HEADER MGRID, 2MM DUAL ROW HDR. SMT				
		4 PLACES ± --- ± --- 3 PLACES ± --- ± --- 2 PLACES ± 0.2 ± --- 1 PLACE ± --- ± ---	CHECKED BY KCL ING	DATE 2004/01/12	MOLEX INCORPORATED				
		ANGULAR ± 3 °	APPROVED BY SKTOH	DATE 2004/01/12	MATERIAL NO. SEE TABLE	DOCUMENT NO. SD-87759-117	SHEET NO. 1 OF 6		
B2	REV DESCRIPTION	DRAFT WHERE APPLICABLE MUST REMAIN WITHIN DIMENSIONS		SIZE A3	THIS DRAWING CONTAINS INFORMATION THAT IS PROPRIETARY TO MOLEX INCORPORATED AND SHOULD NOT BE USED WITHOUT WRITTEN PERMISSION				

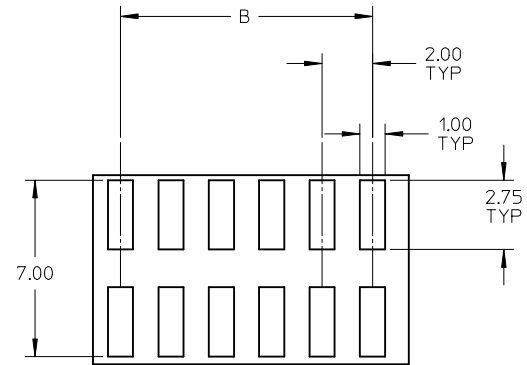
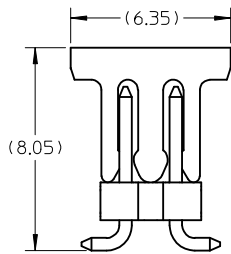

RECOMMENDED SOLDER PAD LAYOUT

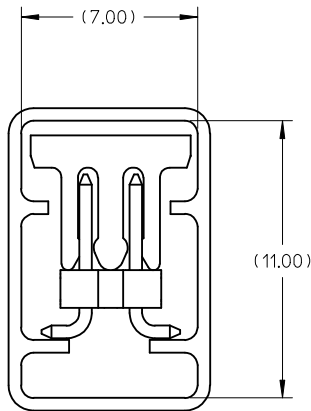

ADD. OPTION EC NO: S2009-0510 DRWN:ATSEE 2009/01/23 CHKD:SKANG 2009/02/09 APPR:MLONG 2009/02/17	QUALITY SYMBOLS ▽=0 ◻=0	GENERAL TOLERANCES (UNLESS SPECIFIED) mm INCH	DIMENSION STYLE MM ONLY	SCALE NTS	DESIGN UNITS METRIC	THIRD ANGLE PROJECTION
	4 PLACES ± --- ± --- 3 PLACES ± --- ± --- 2 PLACES ± 0.2 ± --- 1 PLACE ± --- ± ---	DRAWN BY DATE KSEE 2003/12/12 CHECKED BY DATE KCLING 2004/01/12 APPROVED BY DATE SKTOH 2004/01/12	TITLE CUSTOM HEADER MGRID, 2MM DUAL ROW HDR. SMT			
	ANGULAR ± 3 °	MATERIAL NO. DOCUMENT NO. SEE TABLE SD-87759-117	SHEET NO. 2 OF 6			
	DRAFT WHERE APPLICABLE MUST REMAIN WITHIN DIMENSIONS	THIS DRAWING CONTAINS INFORMATION THAT IS PROPRIETARY TO MOLEX INCORPORATED AND SHOULD NOT BE USED WITHOUT WRITTEN PERMISSION				

EMBOSSED CARRIER TAPE TYPE "A"

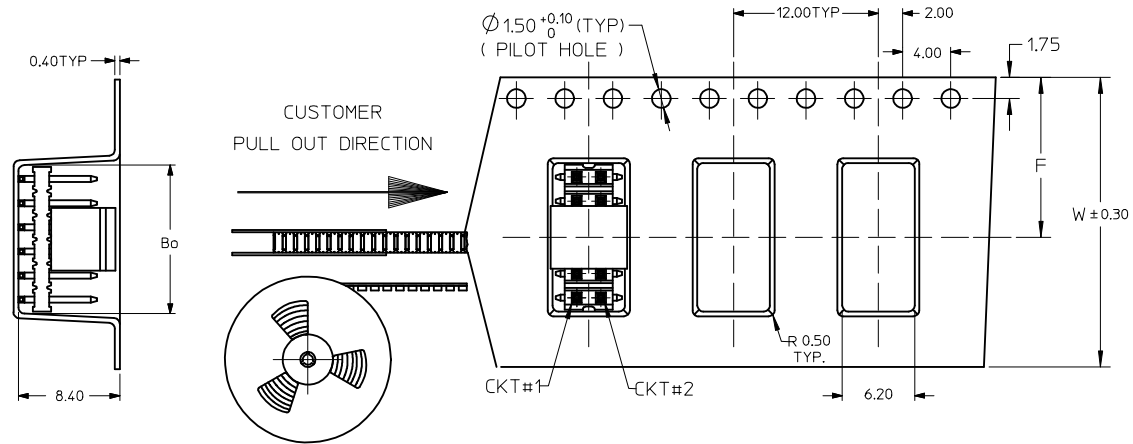

NOTES:

12. LEADER AND TRAILER TAPE



13. PEELING OFF FORCE OF THE TOP TAPE: 20-80gf.
(PEELING DIRECTION AS SHOWN IN FOLLOWING FIGURE)

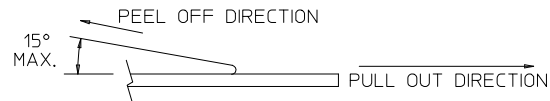

14. PACKAGING STANDARD IS AS PER EIA-481.

15. TAPE & REEL QUANTITY = 750 PCS/REEL

16. THE TAPE IS TREATED FOR ANTI-STATIC

ADD. OPTION EC NO: S2009-0510 DRWN:ATSEE 2009/01/23 CHKD:SKANG 2009/02/09 APPR:MLONG 2009/02/17 REV B2	QUALITY SYMBOLS ▽=0 ▽=0	GENERAL TOLERANCES (UNLESS SPECIFIED) mm INCH 4 PLACES ± --- ± --- 3 PLACES ± --- ± --- 2 PLACES ± 0.2 ± --- 1 PLACE ± --- ± --- ANGULAR ± 3°	DIMENSION STYLE MM ONLY DRAWN BY: KSEE DATE: 2003/12/12 CHECKED BY: KCLING DATE: 2004/01/12 APPROVED BY: SKTOH DATE: 2004/01/12	SCALE: NTS DESIGN UNITS: METRIC THIRD ANGLE PROJECTION	TITLE: CUSTOM HEADER MGRID, 2MM DUAL ROW HDR. SMT MOLEX INCORPORATED DOCUMENT NO. SD-87759-117 SHEET NO. 3 OF 6	
	DRAFT WHERE APPLICABLE MUST REMAIN WITHIN DIMENSIONS		SEE TABLE	THIS DRAWING CONTAINS INFORMATION THAT IS PROPRIETARY TO MOLEX INCORPORATED AND SHOULD NOT BE USED WITHOUT WRITTEN PERMISSION		

EMBOSSED CARRIER TAPE TYPE "B"

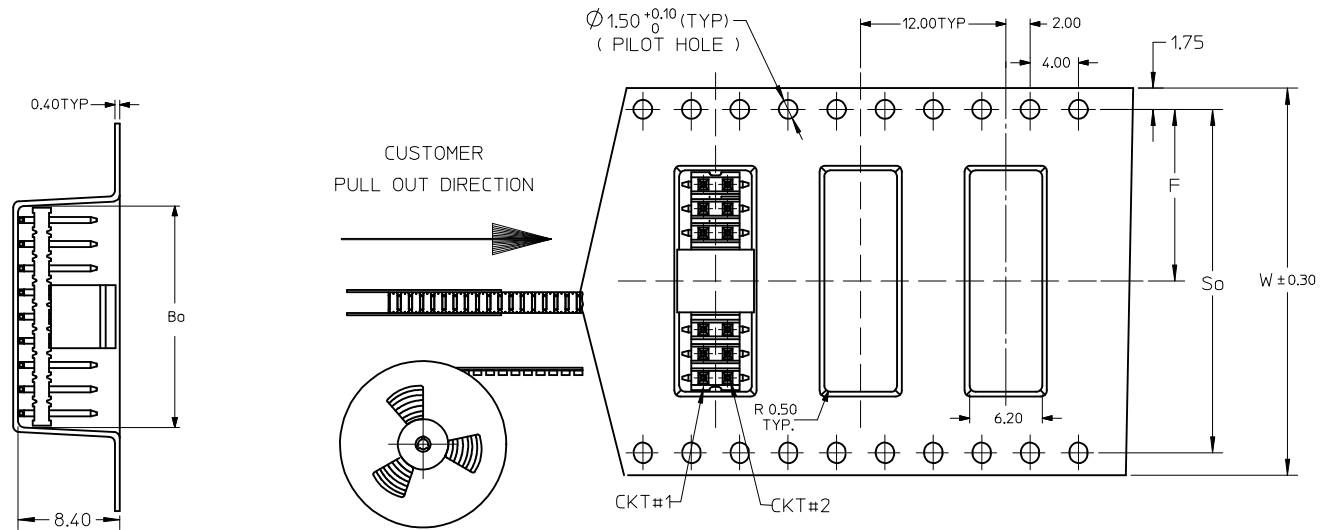

ADD. OPTION EC NO: S2009-0510 DRWN:ATSEE 2009/01/23 CHKD:SKANG 2009/02/09 APPR:MLONG 2009/02/17	QUALITY SYMBOLS ▽=0 ◻=0	GENERAL TOLERANCES (UNLESS SPECIFIED) mm INCH 4 PLACES ± --- ± --- 3 PLACES ± --- ± --- 2 PLACES ± 0.2 ± --- 1 PLACE ± --- ± --- ANGULAR ± 3 °	DIMENSION STYLE MM ONLY DRAWN BY DATE KSEE 2003/12/12 CHECKED BY DATE KCLING 2004/01/12 APPROVED BY DATE SKTOH 2004/01/12	SCALE NTS DESIGN UNITS METRIC THIRD ANGLE PROJECTION	TITLE CUSTOM HEADER MGRID, 2MM DUAL ROW HDR. SMT
	DESCRIPTION B2	DRAFT WHERE APPLICABLE MUST REMAIN WITHIN DIMENSIONS	MATERIAL NO. SEE TABLE	MOLEX INCORPORATED DOCUMENT NO. SD-87759-117	SHEET NO. 4 OF 6
	THIS DRAWING CONTAINS INFORMATION THAT IS PROPRIETARY TO MOLEX INCORPORATED AND SHOULD NOT BE USED WITHOUT WRITTEN PERMISSION				
	SIZE A3				

THIS TYPE OF CARRIER IS FOR CKT SIZE 8 AND BELOW.



ADD. OPTION EC NO: S2009-0510 DRWN:ATSEE 2009/01/23 CHKD:SKANG 2009/02/09 APPR:MLONG 2009/02/17	QUALITY SYMBOLS ▽=0 ◻=0	GENERAL TOLERANCES (UNLESS SPECIFIED)		DIMENSION STYLE MM ONLY	SCALE NTS	DESIGN UNITS METRIC	THIRD ANGLE PROJECTION	
			mm	INCH	DRAWN BY KSEE	DATE 2003/12/12	TITLE CUSTOM HEADER MGRID, 2MM DUAL ROW HDR. SMT	
		4 PLACES ± --- ± ---			CHECKED BY KCLING	DATE 2004/01/12	MOLEX INCORPORATED	
		3 PLACES ± --- ± --- 2 PLACES ± 0.2 ± --- 1 PLACE ± --- ± --- ANGULAR ± 3 °	DRAFT WHERE APPLICABLE MUST REMAIN WITHIN DIMENSIONS		APPROVED BY SKTOH	DATE 2004/01/12	MATERIAL NO. SEE TABLE	DOCUMENT NO. SD-87759-117

	10	9	8	7	6	5	4	3	2	1		
	PART NUMBER WITHOUT CAP IN TUBE	PART NUMBER WITH CAP IN TUBE	PART NUMBER WITH CAP IN TAPE AND REEL.	CKT SIZE	VOID CKTS	A	B	Bo	F	So	W	EMBOSSED TYPE
F	87759-0414 $\triangle_9 \triangle_{10}$	87759-0464	87759-0474	4	--	NA	2.00	5.40	11.50	-	24.00	C
	87759-0614 \triangle_9	87759-0664	87759-0674	6	--	NA	4.00	7.20	11.50	-	24.00	C
	87759-0814	87759-0864	87759-0874	8	--	7.90	6.00	8.20	11.50	-	24.00	C
	87759-1014	87759-1064	87759-1074	10	--	9.90	8.00	10.20	11.50	-	24.00	A
	87759-1002 \triangle_A	87759-1003 \triangle_A	87759-1004 \triangle_A	10	10	9.90	8.00	10.20	11.50	-	24.00	A
	87759-1214	87759-1264	87759-1274	12	--	11.90	10.00	12.20	11.50	-	24.00	A
E	87759-1414	87759-1464	87759-1474	14	--	13.90	12.00	14.20	11.50	-	24.00	A
	87759-1614	87759-1664	87759-1674	16	--	15.90	14.00	16.20	14.20	28.40	32.00	B
	87759-1814	87759-1864	87759-1874	18	--	17.90	16.00	18.20	14.20	28.40	32.00	B
	87759-2014	87759-2064	87759-2074	20	--	19.90	18.00	20.20	14.20	28.40	32.00	B
	87759-2214	87759-2264	87759-2274	22	--	21.90	20.00	22.20	20.20	40.40	44.00	B
D	87759-2414	87759-2464	87759-2474	24	--	23.90	22.00	24.20	20.20	40.40	44.00	B
	87759-2614	87759-2664	87759-2674	26	--	25.90	24.00	26.20	20.20	40.40	44.00	B
	87759-2814	87759-2864	87759-2874	28	--	27.90	26.00	28.20	20.20	40.40	44.00	B
	87759-3014	87759-3064	87759-3074	30	--	29.90	28.00	30.20	20.20	40.40	44.00	B
	87759-3214	87759-3264	87759-3274	32	--	31.90	30.00	32.20	20.20	40.40	44.00	B
	87759-3414	87759-3464	87759-3474	34	--	33.90	32.00	34.20	26.20	52.40	56.00	B
	87759-3614	87759-3664	87759-3674	36	--	35.90	34.00	36.20	26.20	52.40	56.00	B
C	87759-3814	87759-3864	87759-3874	38	--	37.90	36.00	38.20	26.20	52.40	56.00	B
	87759-4014	87759-4064	87759-4074	40	--	39.90	38.00	40.20	26.20	52.40	56.00	B
	87759-4214	87759-4264	87759-4274	42	--	41.90	40.00	42.20	26.20	52.40	56.00	B
	87759-4414	87759-4464	87759-4474	44	--	43.90	42.00	44.20	26.20	52.40	56.00	B
	87759-4614	87759-4664	87759-4674	46	--	45.90	44.00	46.20	26.20	52.40	56.00	B
	87759-4814	87759-4864	87759-4874	48	--	47.90	46.00	48.20	26.20	52.40	56.00	B
B	87759-5014	87759-5064	87759-5074	50	--	49.90	48.00	50.20	34.20	68.40	72.00	B

NOTES:

\triangle_A VOIDED PIN CKT#10 FOR PART#87759-1002

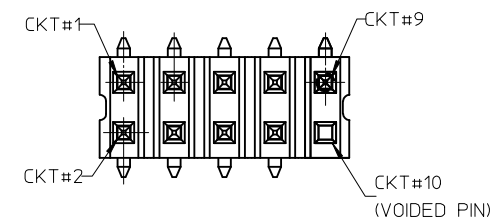

ADD. OPTION EC NO: S2009-0510 DRWN:ATSEE 2009/01/23 CHKD:SKANG 2009/02/09 APPR:MLONG 2009/02/17 B2	QUALITY SYMBOLS $\nabla=0$ $\triangle=0$	GENERAL TOLERANCES (UNLESS SPECIFIED) <table border="1"> <tr> <th></th> <th>mm</th> <th>INCH</th> </tr> <tr> <td>4 PLACES</td> <td>\pm ---</td> <td>\pm ---</td> </tr> <tr> <td>3 PLACES</td> <td>\pm ---</td> <td>\pm ---</td> </tr> <tr> <td>2 PLACES</td> <td>\pm 0.2</td> <td>\pm ---</td> </tr> <tr> <td>1 PLACE</td> <td>\pm ---</td> <td>\pm ---</td> </tr> </table>		mm	INCH	4 PLACES	\pm ---	\pm ---	3 PLACES	\pm ---	\pm ---	2 PLACES	\pm 0.2	\pm ---	1 PLACE	\pm ---	\pm ---	DIMENSION STYLE MM ONLY DRAWN BY: KSEE DATE: 2003/12/12 CHECKED BY: KCLING DATE: 2004/01/12 APPROVED BY: SKTOH DATE: 2004/01/12 MATERIAL NO. SKTOH	SCALE NTS DESIGN UNITS METRIC THIRD ANGLE PROJECTION	TITLE CUSTOM HEADER MGRID, 2MM DUAL ROW HDR. SMT MOLEX INCORPORATED DOCUMENT NO. SD-87759-117	SHEET NO. 6 OF 6
				mm	INCH																
			4 PLACES	\pm ---	\pm ---																
			3 PLACES	\pm ---	\pm ---																
2 PLACES	\pm 0.2	\pm ---																			
1 PLACE	\pm ---	\pm ---																			
DRAFT WHERE APPLICABLE MUST REMAIN WITHIN DIMENSIONS	SEE TABLE	THIS DRAWING CONTAINS INFORMATION THAT IS PROPRIETARY TO MOLEX INCORPORATED AND SHOULD NOT BE USED WITHOUT WRITTEN PERMISSION																			