IMPROVED SENSORLESS CONTROL WITH THE ST62 MCU FOR UNIVERSAL MOTOR

J. NICOLAI, A. BAILLY, T. CASTAGNET

The universal motor is today the most widely used motor in home appliances (vacuum cleaner, washer, hand tool, food processor...). Three modes of operation exist:

- in many cases, it is directly connected to the mains, without any speed adjustment.

More and more, however, the decreasing cost of electronics allows to include an adjustable speed drive in the appliance. The control can be open loop or closed loop:

- in open loop mode, the speed is adjusted by the user but not regulated: it decreases when the load increases. This is the case in many vacuum cleaners for example.

- in closed loop mode, the speed is regulated. This mode is used when the speed must be accurately kept at a given value, in washers for example. This mode requires to add a speed sensor on the motor shaft. Such a sensor is usually a tacho generator or magnet sensor. The drawbacks of the speed sensor are many, but all boil down to higher cost and lower reliability, not to mention the extra bulk needed to accommodate the sensor inside the plastic housing of a drill for example.

This document describes a speed regulator without sensor: the speed sensing is performed indirectly by the ST6220, low-cost 8-bit microcontroller, measuring the motor current. Performance results are given, which are in line with the need of many home appliances.

1 UNIVERSAL MOTOR PRINCIPLES

The universal motor can be driven in AC or DC mode. Figure 1 shows the two most popular variable speed drive principles. The goal is to adjust the voltage seen by the motor in order to adjust its speed. In AC mode, the motor voltage is adjusted by varying the firing delay of a triac. This is done with a diac, resistor and capacitor when lowest cost is desired, and with an 8 bit micro-controller when higher performance and added features are desired, such as user interface or monitoring [1]. The switch is usually a triac, the cheapest power switch.

In DC mode, the motor is supplied by a high frequency pulse width modulated (PWM) DC voltage. The voltage seen by the motor is proportional to the PWM duty cycle, which can be adjusted to modify the speed. The power switch used to chop the DC voltage at high frequency is a power MOS or an IGBT. The DC mode has several advantages versus the AC mode (less acoustic noise, higher efficiency, lower harmonics content, all due to lower current ripple, as is shown in Figure 1). However, in low cost appliances, the AC mode still dominates due to its lower cost (no rectifier bridge, no fast diode, triac cheaper than IGBT or MOS). This is the mode we will focus on in the next pages.

The universal motor is a serial excitation motor. Therefore, the motoring torque is proportional to the square of the motor current: $T_m = k \cdot I^2$

The mechanical power is the product of the torque by the speed: $P = T_m \cdot \Omega$

If we assume 100% efficiency, the mechanical power equals the electrical power $V \cdot I$ input to the motor. It follows that the speed is proportional to V/I :

$\Omega = k' \cdot V / I$ (V and I are *average* voltage and current over a mains period). The first consequence is that the motor speed is proportional to the average motor voltage.

At constant speed, the resistive torque T_r is equal to the motoring torque T_m . It comes from the previous equations that the speed is given by: $\Omega = k \cdot V / \sqrt{T_r}$.

This equation shows that when the resistive load torque increases at a given voltage, the motor speed will decrease, hence the need for speed regulation. This regulation can be performed by adjusting the average voltage V .

Figure 1. Universal motor variable speed drive: AC versus DC mode

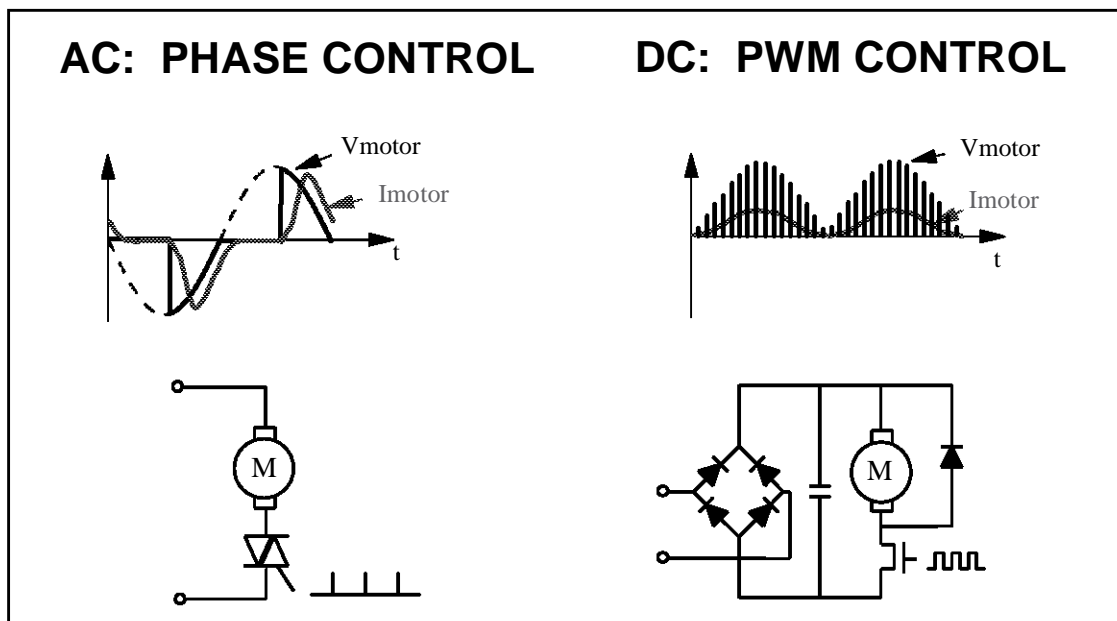

2 SENSORLESS REGULATION PRINCIPLE

The above equations were first order equations, assuming DC operation, or average values for voltage and current. The real, instantaneous equation is the following:

While the triac is off:

$$i = 0$$

While the triac is on (after firing time t_d , and until current comes back to zero; see Figure 2):

$$v = e + z.i$$

with: e = back electromotive force (bemf) = $k \cdot \Omega \cdot i$

z = motor impedance = $r + j.L.\omega$

k = constant dependent upon motor characteristics

Ω = motor speed

i = instantaneous motor current

v = instantaneous motor voltage

L = motor inductance

r = winding resistance

ω = mains frequency

$$v = (k.\Omega + r) i + j.L.\omega.i$$

Figure 2. First Order Model (resistive only): Constant Speed, Variable Load

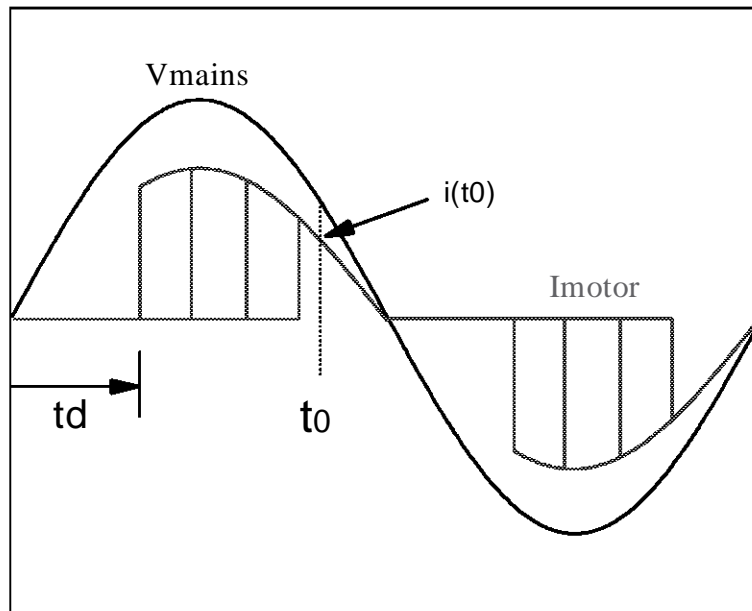

In the time domain, $v(t)$ is the mains voltage: $v(t) = V0 \cdot \sin\omega t$ ($V0$ = mains peak voltage).

At first order, we will neglect the inductive term $j.L.\omega$. This yields: $i(t) = k.\Omega + r$.

The universal motor behaves as a speed-dependent resistor of value $k.\Omega + r$.

As Ω and r do not change very quickly, and v is known, measuring i at a specific time within the mains period (example: at time t_0 in Figure 2) gives an image of the motor speed: $\Omega = (V_0 / k. i(t_0)) \sin\omega t_0 - r / k$.

Therefore if we want to keep the speed at a fixed value Ω_0 , we need to keep $i(t_0)$ at a corresponding fixed value i_0 :

$$i_0 = V_0 .\sin\omega t_0 / (k.\Omega_0 + r)$$

In practice, each mains period, the micro-controller measures the current at time t_0 with its internal analog to digital converter. Then, the current error $i(t_0)-i_0$ is calculated, and the micro executes the speed regulation algorithm, which results in a new firing delay t_d . This delay is used to fire the triac on the next mains period. It is counted by the micro controller internal timer. The delay is measured starting from the mains voltage zero-crossing.

Figure 3. Measured Current in a Real Motor (resistive and inductive): Constant Speed, Variable Load (1: lowest load, 3: highest load)

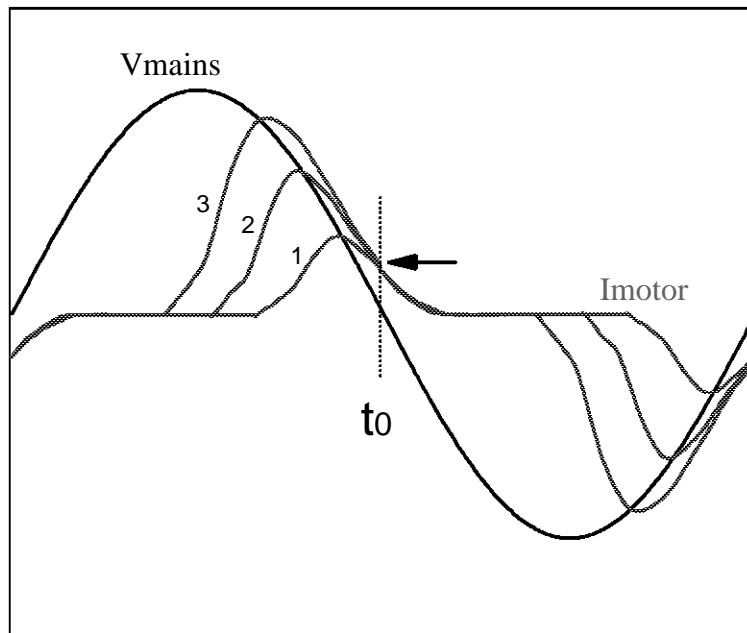

If we now consider the real universal motor, including the inductive term $j.L.\omega$, we can apply the same method. Figure 3 shows the current and mains voltage for a real motor. On this figure, while the load is modified, the speed is kept constant by modi-

ying the triac firing delay. Moving from Figure 2 to Figure 3, we can see two effects of the inductive term. First effect: at triac turn-on, the motor current does not exhibit a discontinuity, but changes gradually from 0 to a finite value. Second effect: at mains voltage zero crossing, the motor current does not reach zero immediately, but keeps trailing for a few milliseconds. This trailing gives us more freedom to choose the measurement time t_0 . We can even choose the zero crossing instant, which is the easiest time for the micro-controller (no need to measure time t_0 with the timer, we can use the mains zero-crossing as an interrupt to the micro, which is necessary anyway for other matters). This is illustrated in Figure 3, where the arrow shows that the current is constant at the zero-crossing time while the motor load changes, provided that the speed is kept constant by adjustment of the firing delay t_d . For a detailed mathematical discussion, see annex 1.

To summarize, if we want to regulate the speed at a pre-defined set speed, for example 1000 rpm, we must measure the instantaneous motor current on every mains period at the same time t_0 (for example, on every mains voltage zero crossing following the positive half-cycle), and maintain this measured current at a fixed set current, 1 ampere for example. For a different set speed, 2000 rpm, we need to regulate the current around a different value, 0.5 ampere for example (note that a lower current corresponds to a higher speed).

The regulation is performed by adjustment of the triac firing delay t_d .

The above described method gives very good results at medium and high speeds.

At very low speeds, we have a second order effect coming into the picture: Figure 4 is identical to Figure 3, except for the presence of a fourth current curve, corresponding to a very large firing delay t_d (this corresponds to a very low speed, combined with a low load). We can see on this fourth curve that the current at time t_0 is smaller than i_0 , current of the other 3 curves at this time. This effect is described in detail in annex 1. We have two solutions to cope with it. The simplest one is to limit the maximum firing delay (below values in the range of 7 mS, depending on the motor type). This means limiting the minimum speed which can be regulated. If the application cannot tolerate this reduction in its speed dynamic range, a second and more complex solution is to compensate this current measurement distortion, by means of look-up tables memorized in the micro-controller memory. When the current $i(t_0)$ is measured, if t_d is larger than a limit value (7 mS for example), $i(t_0)$ is increased by a compensation value extracted from a memory table before it is used to calculate the current error. This value is a function of the triac firing delay t_d , and is determined experimentally by characterizing the motor. The regulation system is not very sensitive to this value, so it is enough to characterize one motor of a given type, it is not neces-

sary to characterize each individual motor. Annex 2 describes how to determine this compensation table.

Figure 4. Measured Current at Constant Speed (for very large firing delays, current at time t_0 is lower than set current)

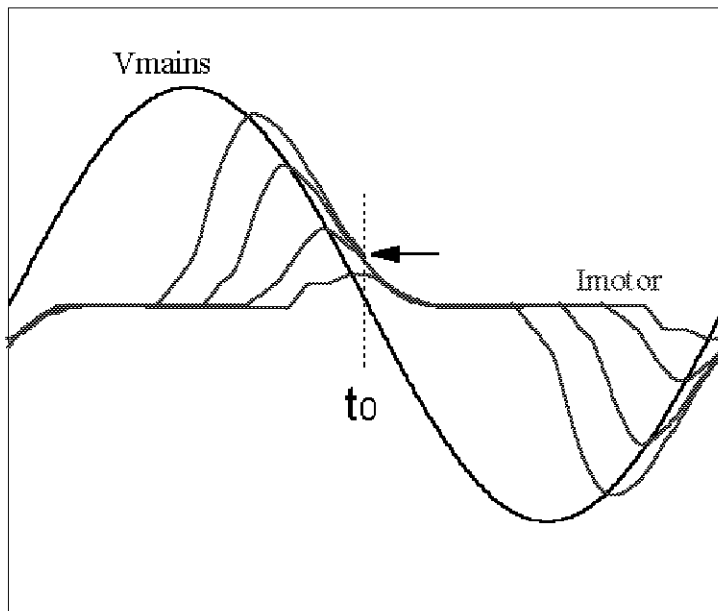

3 IMPLEMENTATION

Figure 5 gives a schematic of the sensorless motor drive. The heart of the system is the micro-controller, the ST6220, a low cost 8-bit general purpose micro. It is supplied directly from the mains by the capacitive supply made of components R2/C1/C2/C3 and of the two diodes. This is made possible by its low current consumption, in the range of 4 mA. This capacitive supply must be dimensioned to supply the micro, the operational amplifier, and the triac gate during the firing. Resistor R1 is the current sense resistor, it is only 0.22 ohm in order to keep the losses as low as possible (in this example, the motor is a 500 watts type). For this reason, an operational amplifier is needed in order to provide the micro-controller analog-to-digital converter input (pin PB1) with a large enough voltage. As this analog-to-digital converter (ADC) is an 8 bit type, its resolution (minimum voltage step discernible at its input) is around 20 mV when the micro is supplied from 5 volts. The larger the voltage on the ADC input, which is the op-amp output after some noise filtering by R6 and C5, the better the resolution on measured current $i(t_0)$, which will be used latter in the speed regulation algorithm. A value around 1 volt is a reasonable compromise. The op-amp must be a rail-to-rail type, at the output and inputs as well: for the input, the voltage measured on the sense resistor is very low, and referred to the positive supply VDD. The output should be able to swing from the micro-controller ground level to its VDD level, which are the same as for the op-amp itself, in order to make full usage of the ADC dynamic range.

Two noise filters (R10/C4 and R6/C5) are provided to remove brush noise from the motor current signal, before it is measured by the internal ADC. Depending on the motor, and with careful design, it is possible to do with only one filter.

Resistors R3, R4 and capacitor C6 are used to shape the mains voltage before sending it to the micro input pin PB0. This digital signal, which shows an edge at each zero-crossing of the mains (positive or negative edge depending on the half-cycle sign), interrupts the micro-controller program to signal the zero-crossing. It is used to synchronize the triac firing with the mains, and to trigger the ADC reading in order to acquire the current value $i(t_0)$.

4 SOFTWARE DESCRIPTION

Figure 6 illustrates the micro-controller program operation. The program consists of a loop synchronized on the mains zero-crossing (z.c.). Each zero-crossing causes an interrupt on pin PB0 of the micro. In case of a positive half-cycle, the motor current $i(t_0)$ is measured and saved into variable it_0 for latter use. Then, in both cases (positive and negative half-cycle), the micro uses the timer to wait an amount of time $t_d \times 48 \mu\text{S}$, after which it fires the triac with pins PA0,PA1,PA2 ($48 \mu\text{S}$ is the chosen timer step). Three pins are used in order to supply up to $3 \times 20\text{mA}$ to the triac gate. The timer is used again to keep the gate activated during $400 \mu\text{S}$ ($\text{TGATE} \times 48 \mu\text{S}$). After the end of the triac gate activation, two tasks remain to accomplish: in the positive half-cycle, the micro reads the push-buttons (or potentiometer) to check the user speed demand; in the negative half-cycle, the regulation algorithm is executed, resulting in the calculation of a new value for t_d , to be applied on next mains cycle. When this is done, the micro returns to wait mode until the next zero-crossing interrupt happens.

•Regulation algorithm: proportional-integral regulation

This algorithm is contained within the subroutines “regul” and “pi”. Its input is the variable it_0 (current measured at zero-crossing), and its output the triac firing delay t_d (each unit corresponds to $48 \mu\text{S}$ delay). The variable it_0 is first increased by a compensation value extracted from a memory table before it is used to calculate the current error. This value is a function of the triac firing delay t_d . The current error, i_err , is then obtained by subtracting the current demand $icalc_0$, which depends only upon the user speed demand. The micro then calculates the proportional and integral terms of the proportional-integral algorithm: they are simply the current error i_err multiplied by constants (K_P and K_I). In the attached example, $K_P = 1/4$ and $K_I = 1/32$, but these coefficients must be adjusted for a given motor type. They dictate the transient behavior of the regulation. As there is no multiplication instruction in ST6 micro controllers, it is chosen to multiply or divide only by powers of two ($1/4$, $1/32$, $1/8$...) as this is fast and easy to perform by software. Subroutines for multiplication by $1/4$, $1/8$, $1/16$, $1/32$, $1/64$ are given in the program. In practice, this restriction is not a problem, as the transient performance is not very sensitive to these coefficients.

If we note with index (n) the variables related to the nth mains cycle, the complete PI (proportional-integral) algorithm can be expressed by:

$$i_err(n) = it0(n-1) + table(td(n-1)) - icalc0$$

$$sum(n) = sum(n-1) + KI * i_err(n)$$

$$td(n) = VITMIN - [sum(n) + KP * i_err(n)]$$

table(td(n-1)) is the current compensation coefficient extracted from the table, and associated to the corresponding value of the firing delay td, td(n-1).

sum(n) is the integral term, and KP * i_err(n) the proportional term. VITMIN is a constant equal to the maximum firing delay (150 x 48 μS = 7.2 mS in the example).

This is expressed in the program by:

```
i_err <- it0 + table(td) - icalc0
```

```
sum <- sum_old + KI * i_err
```

```
temp1 <- sum + KP * i_err
```

```
td <- VITMIN - temp1
```

```
sum_old <- sum
```

Figure 6. The program is a loop synchronized on the mains zero crossing (z.c.). It is identical on both half-cycles, except for the $i(t_0)$ current measurement, regulation subroutine and speed demand subroutine

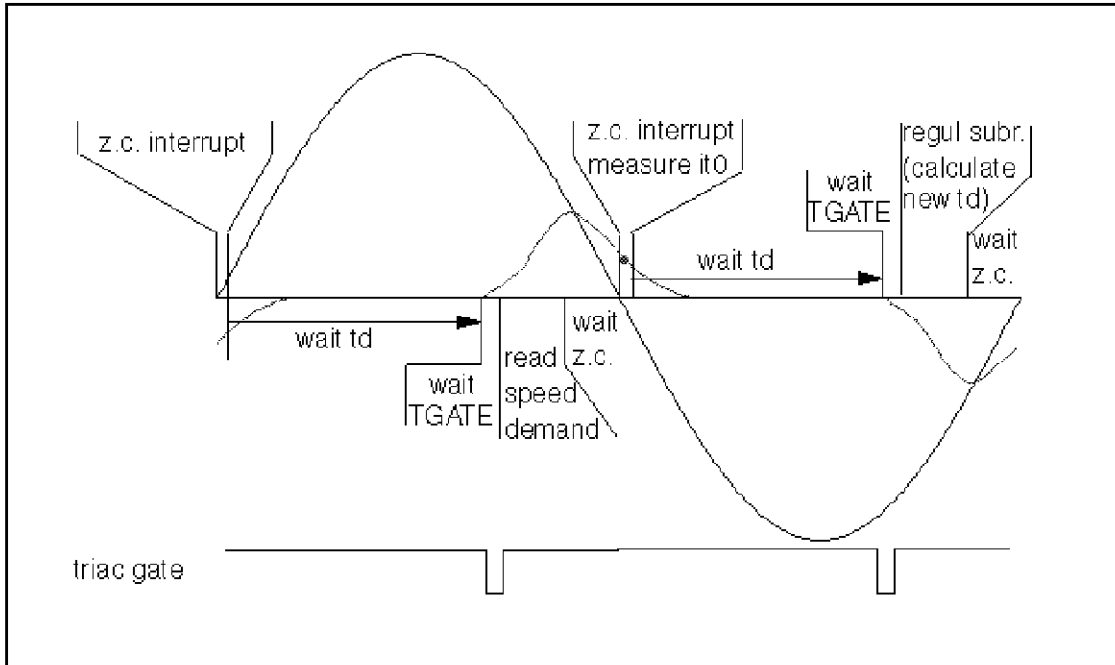

The adaptation of the program to a specific motor type can be done by adjusting the coefficients K_I and K_P , and the contents of compensation table $table(td)$. The table is necessary only for the largest firing delays (slow speed). The slower the motor should be able to run, the more attention should be given to the elaboration of this table.

The proportional coefficient K_P adjusts how strongly the system reacts to a speed error: the larger this coefficient, the faster the reaction to load change, but if this term becomes too large, some instability may occur. The integral coefficient K_I adjusts the transient settling time when the load changes: the larger K_I , the faster the settling time, but again, instability may occur if this coefficient becomes too large. Trial and error is the best way to find the best compromises.

The latest detail which must be mentioned in the program is the operational amplifier gain adjust. At high speed, current $i(t_0)$ becomes very small; if we want to measure it with a reasonable accuracy, we must amplify it even more than in case of low speed. This is why the op-amp is fitted with a dual gain scheme, with help of resistor R_5 , connected to VDD or left open by the micro pins PB2/PB3/PB4. The op-amp gain is set to 10 for the low speed range, 40 for the high speed range. This gain setting is managed in subroutine "speed", which also checks for user speed demand.

5 REGULATION PERFORMANCE

Figures 7, 8, 9 show the regulation performance at three speeds typical of a drill. The horizontal axis shows the motor rms current, which is proportional to the load. The first two figures show reasonable performance: speed is kept constant within $\pm 10\%$. The last figure, corresponding to a very low speed of 400 rpm, shows a speed increase when the load increases. This can be improved somewhat by fine tuning the compensation table. Creating a different table for each set speed would also improve the performance for a given set speed (for example, one table for set speeds 400-600 rpm, one for 600-900 rpm, one for 900-1300 rpm, etc... the example program provides only one table for the whole speed range). However, it should be noted that the difficulty to find the best compromises increases considerably when we want to regulate the motor at slower and slower speeds. This is easy to understand conceptually, as the quantity that we actually measure and regulate is $k\cdot\Omega + r$. When we move towards slower speeds, the relative importance of the term $k\cdot\Omega$ compared to the resistive term r becomes smaller and smaller. Also, at very low speeds, friction becomes predominant. This limits the usefulness of the system to moderate speed range applications.

6 CONCLUSION

This document showed how to regulate the universal motor speed without speed sensor, with the help of a low cost micro controller. The price to pay is some accuracy loss in the speed regulation, in the order of 10%. In most home appliance applications, such speed variation with varying load is fully acceptable. When the micro investment has been made, it is a good idea to make use of its inherent benefits, flexibility, ease of customization, fast time to market. In a washing machine for example, the micro can also be used to generate the speed ramps and washing / rinsing sequences, and control the unbalance; in a drill, it can be used to control or limit the torque. In the long term, the universal motor should be replaced more and more by brushless "electronic" motors, such as the DC permanent magnet brushless, or the switched reluctance motor, due to their higher efficiency and dynamic performances. However, cost reductions such as the one described in this document should allow the universal motor to compete successfully for many years in the most cost sensitive applications.

Figures 7, 8, 9. Speed regulation performance (with and without regulation) for set speeds of 1700, 950 and 400 rpm on a 500W drill. Speeds are measured after reduction, on the tool shaft

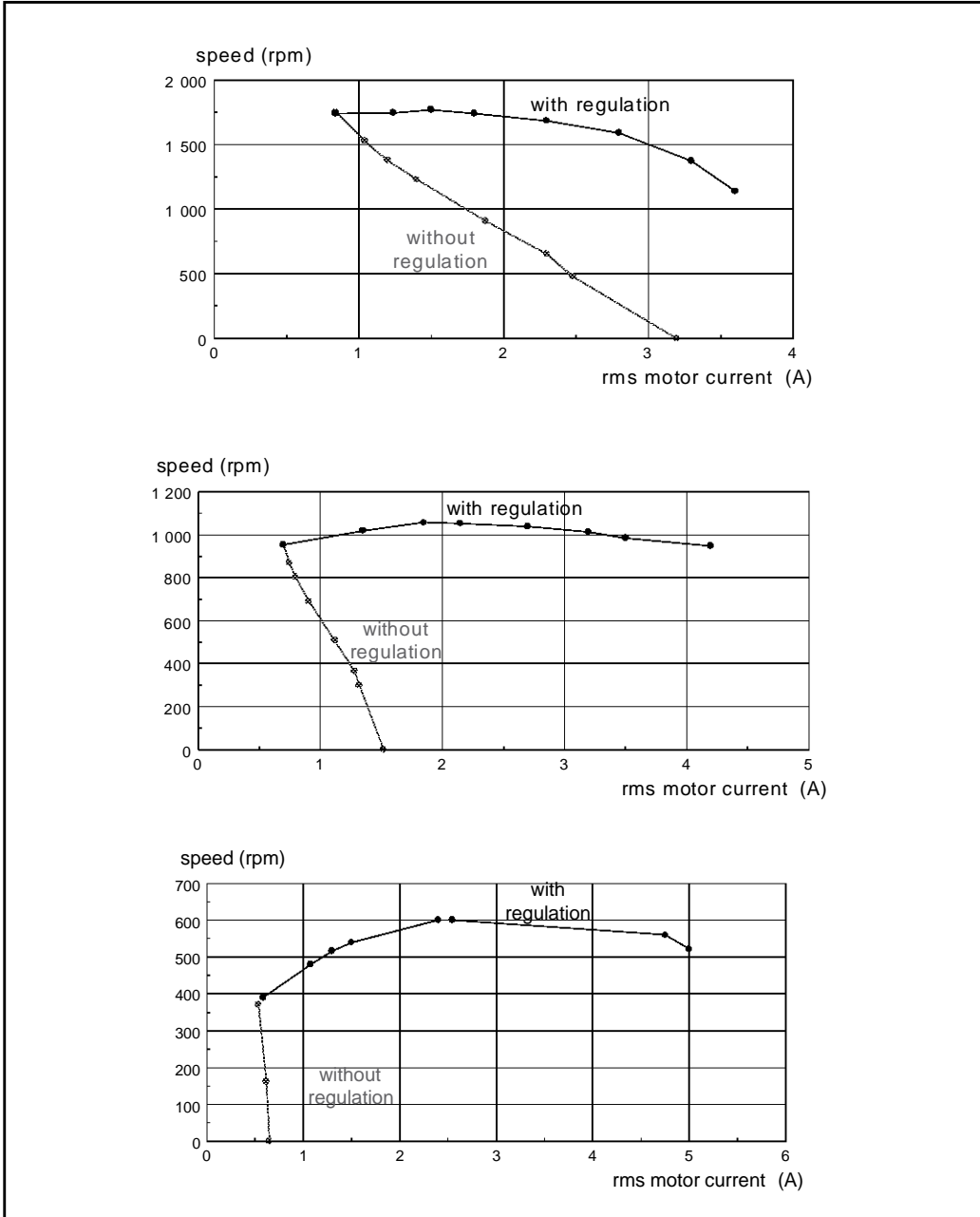

7 REFERENCES

- [1] Power control with triacs and ST6210 MCU
AN392 - P. Rabier and L. Perier (SGS-THOMSON Microelectronics)
- [2] Digital control for brush DC motor
T. Castagnet and J. Nicolai (SGS-THOMSON Microelectronics)
PCIM Nuremberg, June 93
- [3] Sensorless motor drive with the ST62 MCU + TRIAC
AN416 - T. Castagnet (SGS-THOMSON Microelectronics)

8 ANNEX

ANNEX 1 MOTOR CURRENT CALCULATION

The motor voltage equation is: $v(t) = (k.\Omega + r) i(t) + L di/dt$

$v(t) = 0$ while the triac is off (before turn on at time t_d , and after the turn off caused by the motor current reaching 0)

$v(t) = V_0 .\sin\omega t$ while the triac is on

The solution to the differential equation is:

$i(t) = 0$ while the triac is off

While the triac is on:

If we neglect the inductance L: $i(t) = V_0 \sin\omega t / (k.\Omega + r)$

If we do not neglect the inductance:

$i(t) = -\exp(-A(t-t_d)/L) [B \sin \omega t_d + C \cos \omega t_d] + B \sin \omega t + C \cos \omega t$

with: $A = k.\Omega + r$

$$B = AV_0 / (A + L \omega)$$

$$C = -L \omega V_0 / (A + L \omega)$$

t_d = triac firing delay measured from mains zero-crossing

Figure 10 is a plot of $i(t_0)$ versus t_d at constant speed. Modifying the speed parameter generates a family of curves. In Figure 11, t_0 equals 10 mS: the current $i(t_0)$ is measured at the mains voltage zero crossing.

Figure 11 is a plot of $i(t)$ versus t at constant speed. Modifying the parameter t_d (triac firing delay) generates a family of curves

Figure 10. calculated current versus time at constant speed for various triac firing delays (resistive and inductive model). Current at t_0 is constant, except at the largest firing delay t_d of 9 mS.

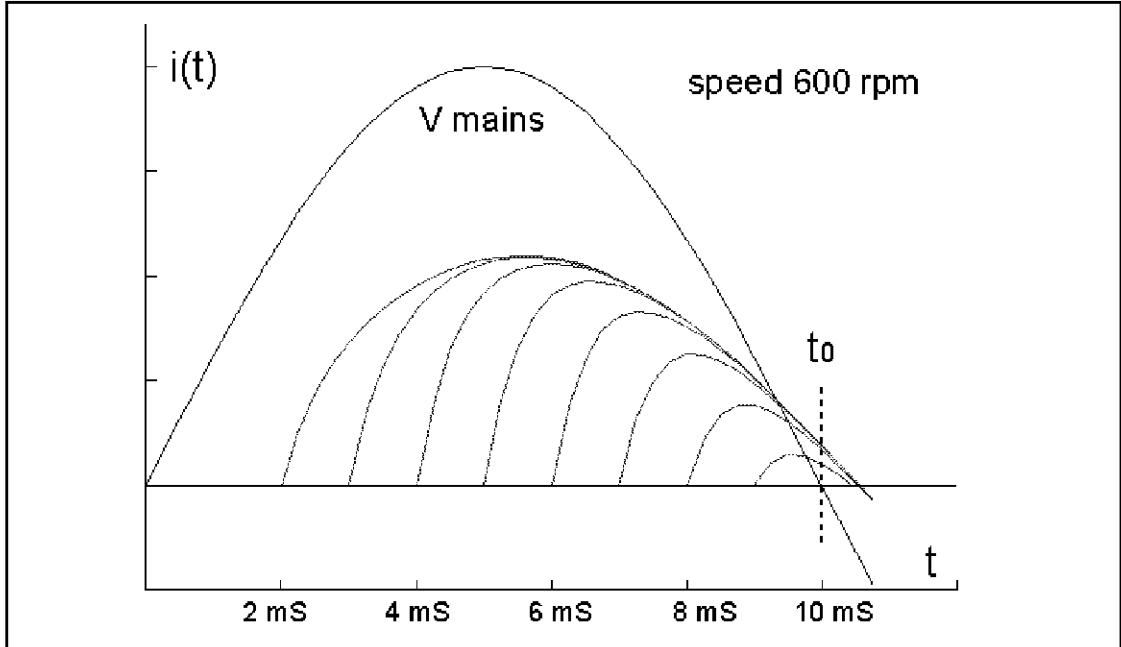
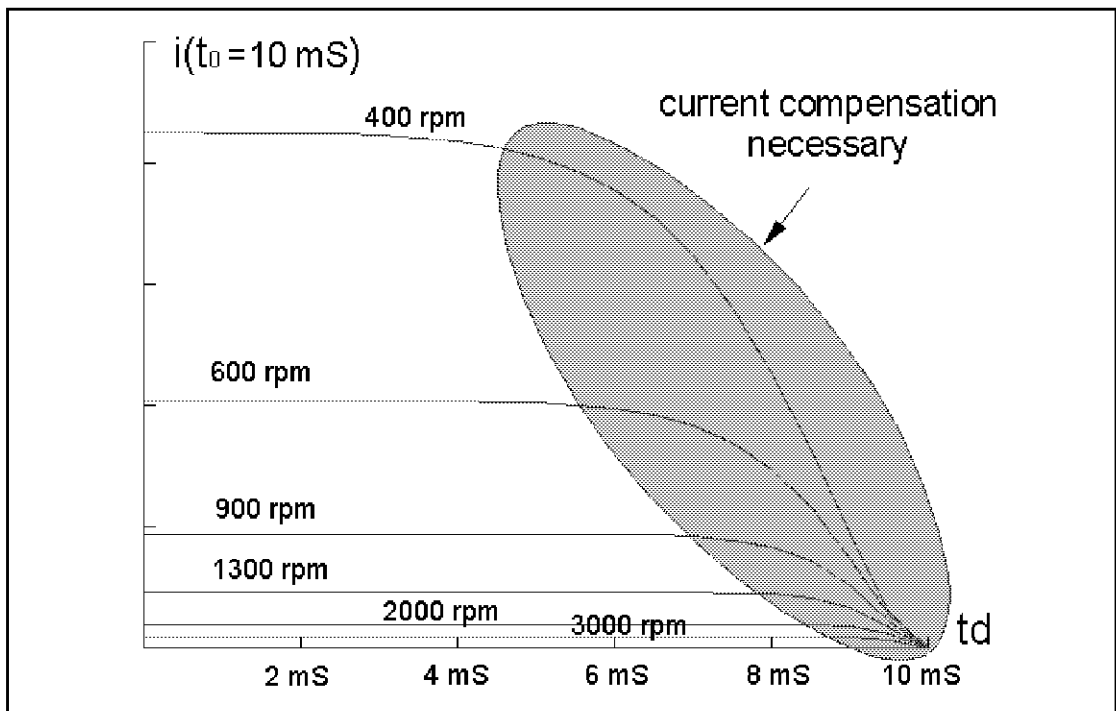

Figure 11. calculated current at mains zero crossing versus firing delay for various speeds. For speeds larger than 600 rpm and firing delays smaller than 7 mS, this current depends only upon speed.



ANNEX 2 CREATING THE CURRENT COMPENSATION TABLE

A second assembly program is provided, named `caract.asm`. It must be used in place of `regul.asm`. Its purpose is to allow characterization of the motor in order to create the table. Contrary to `regul.asm`, it does not perform any regulation, but instead fires the triac at a constant delay `td` which can be adjusted through the whole range (VITMAX to VITMIN) by means of the two push buttons. At the same time, the RS232 connection allows to measure the present values for `td` (firing delay) and `it0` (measured current at zero crossing), as explained in annex 3. The procedure to follow is described below:

- select the desired speed for which the table must be optimized. Figure 12 gives an example (600 rpm) of the shape that current `it0` has while `td` is varied. This curve is in fact one of the curves family in Figure 12 of annex 1. This speed is obtained with no load by adjusting `td` with the push-buttons. The RS232 connection allows to measure and record `td` and `it0` when the desired speed is obtained.
- add a small constant load on the motor shaft. The speed naturally decreases. Then decrease the firing delay `td` with the push buttons until the speed is back to 600 rpm. At this time, record `td` and `it0`.
- increase slightly the load. Decrease `td` to come back to 600 rpm. Record again `td` and `it0`. Keep increasing the load until `td` reaches the minimum allowed, and record a few couples (`td,it0`).
- If you make a graph of the couples (`td,it0`) with `td` in abscissa, you will obtain a curve similar to the one in Figure 12. Subtracting the current value for small `td`, approximately 80 in Figure 12, will give the values for the look-up table: the table coefficients are zero for `td` = 0 to 4mS, then increase regularly up to approximately 22 for `td` = 8mS. (note that, for the vertical axis, the values given are not amperes, but register values output by the ADC converter. They can be related to the actual current by taking account that the ADC value changes by one unit for 20 mV voltage change at its input PB1: when the input is maximum, 5 volts, the ADC value is 255). In the example of Figure 12, the table will look similar to the following:

<code>td (mS)</code>	0	1	2	3	4	5	5.5	6	6.5	7	7.5	8
<code>coefficient</code>	0	0	0	0	0	3	4	7	10	15	18	22

Figure 12. Variation of the current at zero-crossing i_{t0} versus firing delay t_d at 600 rpm, while the load is varying. The cross-hatched area is not allowed, as friction keeps the motor stalled for very large firing delays. The set of vertical lines is a graphic representation of the table contents.

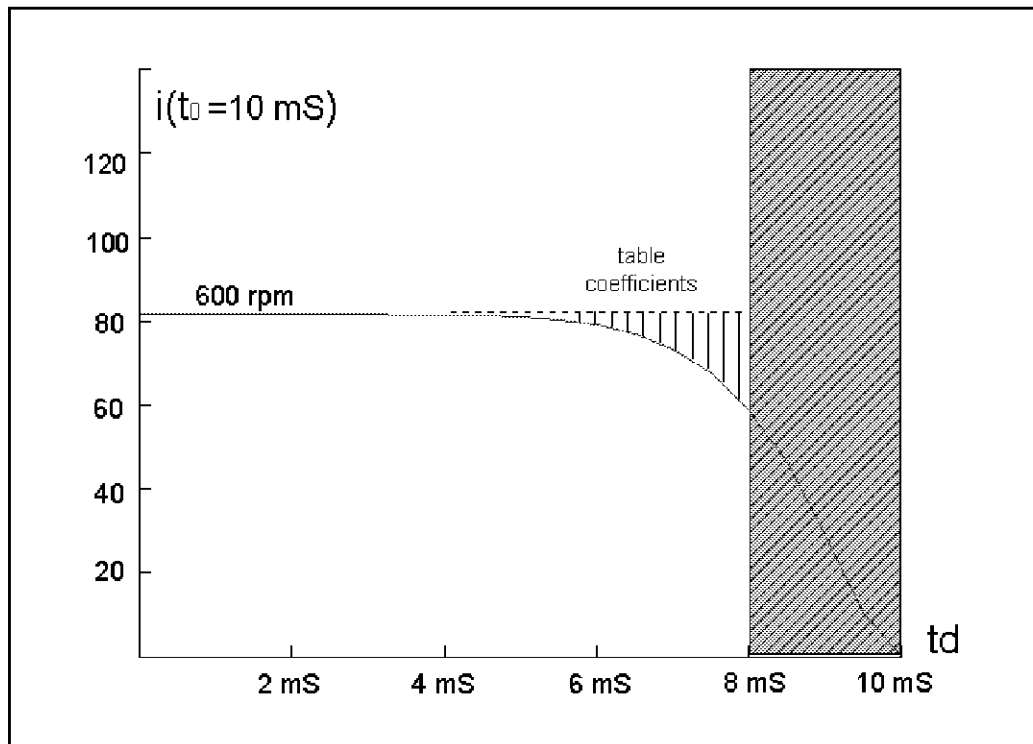

ANNEX 3 MONITORING ON A PC COMPUTER SCREEN

In order to monitor various variables during the motor characterization, an RS232 connection is provided in the micro-controller software between the ST6 and a personal computer. In the program "regul.asm", two data bytes are sent to the PC every mains cycle: on negative half-cycles, the measured current i_{t0} is sent, and on positive half-cycles, the calculated firing delay t_d is sent. The instructions used to send this data are the following:

for the i_{t0} byte:

```
ld  a, it0
call rs232
```

and for the t_d byte:

```
ld  a, td
call rs232
```

When it is called, the rs232 subroutine sends at 19200 bauds on port pin PA3 the data byte contained in the accumulator. This takes approximately 0.5 mS. Replacing i_{t0} or t_d by another register or RAM variable allows to send any intermediate calculation result or variable (coefficient from look-up table, proportional term, integral term, current error...). To connect the PA3 and VDD micro-controller pins to the PC require a level amplification (to boost the signal level from 0-5 volts to -5 / +5 volts) performed by a Maxim MAX232 circuit, and galvanic isolation, performed by an optocoupler (see Figure 13). The 9-pin connector must be connected to the COM1 serial port of the PC.

On the PC side, two executable programs are provided: NUMBER.EXE and VISU.EXE.

NUMBER.EXE, executed on the PC while the motor is running, displays on the screen two rows of data in decimal format representing the evolution in time of the received data i_{t0} and t_d . The two rows scroll down the screen, and at the same time are stored in a text file named NUMBER.PRN. Hitting any key stops the program execution. The data file NUMBER.PRN remains, available for latter use. It can be imported into a spreadsheet program for example, to visualize the curves representing in time domain the evolution of i_{t0} and t_d .

Program VISU.EXE, on the other hand, allow to display graphically in real time the time domain evolution of i_{t0} and t_d . The attached file EGAVGA.BGI must be present in the same directory, and the PC must have a VGA (or better) screen, as the graphic is displayed in 640x480 pixels resolution. Hitting any key (except "e") stops temporarily the curves drawing, so the user can pause to examine a detail of the display.

IMPROVED SENSORLESS CONTROL WITH THE ST62 MCU FOR UNIVERSAL MOTOR

Hitting afterwards any key (except “e”) will resume normal operation. Hitting key “m” twice stores the data presently displayed on the screen in a text file named VISU.PRN under the same format as NUMBER.PRN, for latter use. Hitting key “e” terminates the program execution. Figure 14 is an example of a file VISU.PRN imported into a spreadsheet program. This is also what is displayed on the PC screen in real time while the motor is running, and the program VISU.EXE is executing.

Figure 13. Connection motor control board - Personal computer by RS232 serial link. The DB9 connector must be connected to the COM 1 serial port of the computer.

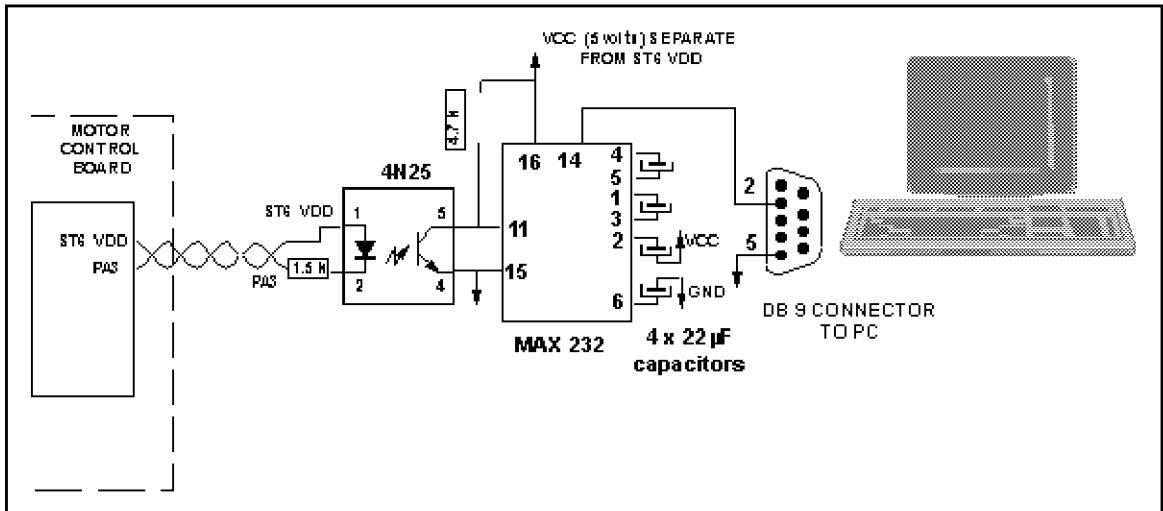
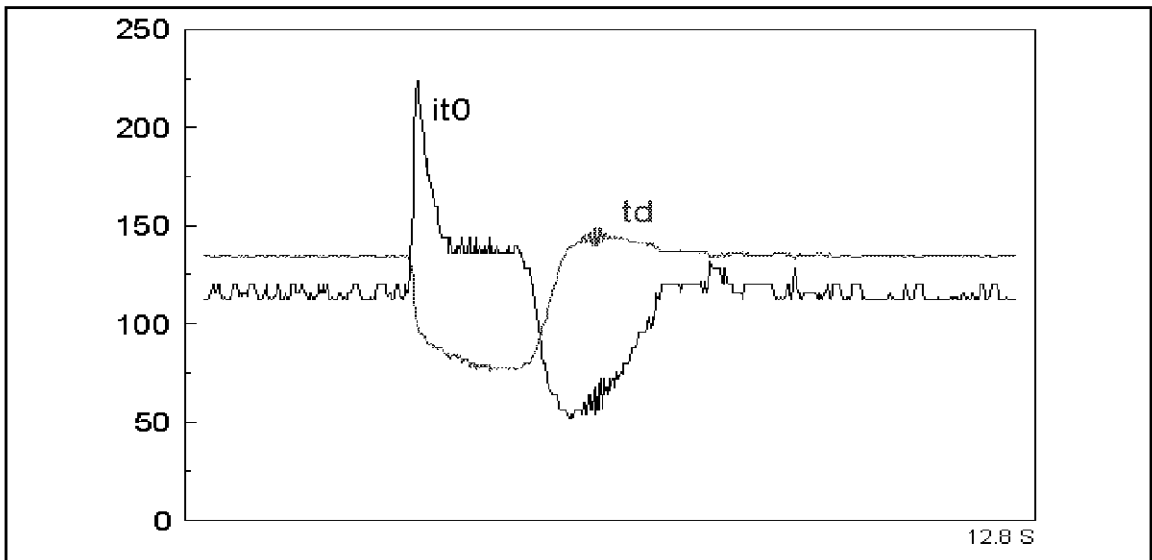

Figure 14. Measured data as displayed on the PC screen. The horizontal axis represents 640 points, taken every 20 mS, for a total of 12.8 seconds. The curves show the regulation response to a load step.



IMPROVED SENSORLESS CONTROL WITH THE ST62 MCU FOR UNIVERSAL MOTOR

Notes:

Information furnished is believed to be accurate and reliable. However, SGS-THOMSON Microelectronics assumes no responsibility for the consequences of use of such information nor for any infringement of patents or other rights of third parties which may result from its use. No license is granted by implication or otherwise under any patent or patent rights of SGS-THOMSON Microelectronics. Specifications mentioned in this publication are subject to change without notice. This publication supersedes and replaces all information previously supplied. SGS-THOMSON Microelectronics products are not authorized for use as critical components in life support devices or systems without the express written approval of SGS-THOMSON Microelectronics.

©1996 SGS-THOMSON Microelectronics - All rights reserved.

Purchase of I²C Components by SGS-THOMSON Microelectronics conveys a license under the Philips I²C Patent. Rights to use these components in an I²C system is granted provided that the system conforms to the I²C Standard Specification as defined by Philips.

SGS-THOMSON Microelectronics Group of Companies

Australia - Brazil - Canada - China - France - Germany - Hong Kong - Italy - Japan - Korea - Malaysia - Malta - Morocco - The Netherlands
Singapore - Spain - Sweden - Switzerland - Taiwan - Thailand - United Kingdom - U.S.A.