

1. PART NO. EXPRESSION :

SSC05032R5YZF-□□
 (a) (b) (c) (d)(e)(f) (g)

- (a) Series code
- (b) Dimension code
- (c) Inductance code : 2R5 = 2.5uH
- (d) Tolerance code : Y = ±30%
- (e) X, Y, Z : Standard part
- (f) F : RoHS Compliant
- (g) 11 ~ 99 : Internal controlled number

2. CONFIGURATION & DIMENSIONS :

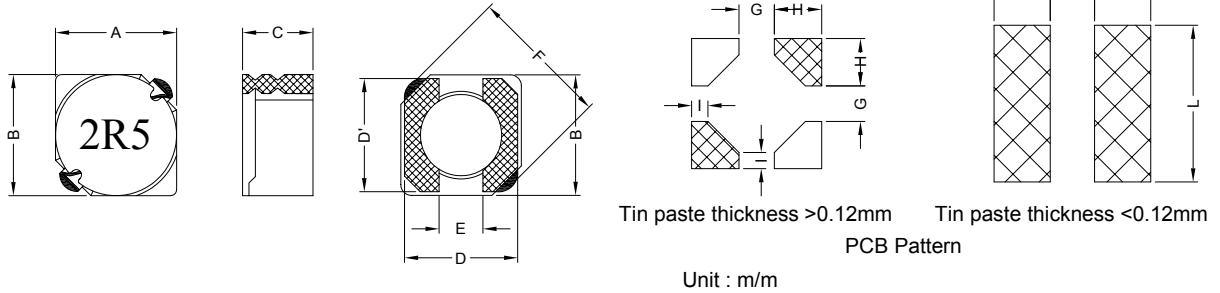

A	B	C	D	D'	E	F
5.70±0.3	5.70±0.3	3.00 Max.	5.50 Ref.	5.50 Ref.	2.00 Ref.	8.20 Max.
G	H	I	J	K	L	
2.20 Ref.	2.05 Ref.	0.85 Ref.	2.15 Ref.	2.00 Ref.	6.30 Ref.	

3. SCHEMATIC :

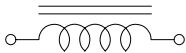

4. MATERIALS :

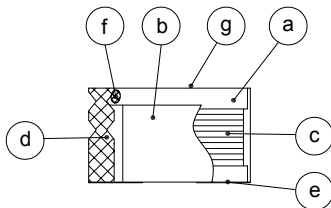

- (a) Core : DR Ferrite Core
- (b) Core : RI Ferrite Core
- (c) Wire : Enamelled Copper Wire
- (d) Terminal : Au+Ni Copper Plate
- (e) Adhesive : Epoxy
- (f) Adhesive : Epoxy
- (g) Ink : Bon Margue



RoHS Compliant

NOTE : Specifications subject to change without notice. Please check our website for latest information.

04.10.2010

5. GENERAL SPECIFICATION :

- a) Temp. rise : 30°C Max. at rated current
- b) Rated current : Base on temp. rise & $\Delta L/L0A = 35\%$ Max.
- c) Storage temp. : -40°C to +125°C
- d) Operating temp. : -40°C to +95°C
- e) Resistance to solder heat : 260°C.10 secs

6. ELECTRICAL CHARACTERISTICS :

Part No.	Inductance (μ H)	Test Frequency (Hz)	RDC (m Ω) Max.	IDC (A) Max.
SSC05032R5YZF-□□	2.5 \pm 30%	0.5V / 10K	18	2.60
SSC05033R0YZF-□□	3.0 \pm 30%	0.5V / 10K	24	2.40
SSC05034R2YZF-□□	4.2 \pm 30%	0.5V / 10K	31	2.20
SSC05035R3YZF-□□	5.3 \pm 30%	0.5V / 10K	38	1.90
SSC05036R2YZF-□□	6.2 \pm 30%	0.5V / 10K	45	1.80
SSC05038R2YZF-□□	8.2 \pm 30%	0.5V / 10K	53	1.60
SSC0503100YZF-□□	10.0 \pm 30%	0.5V / 10K	65	1.30
SSC0503120YZF-□□	12.0 \pm 30%	0.5V / 10K	76	1.20
SSC0503150YZF-□□	15.0 \pm 30%	0.5V / 10K	103	1.10
SSC0503180YZF-□□	18.0 \pm 30%	0.5V / 10K	110	1.00
SSC0503220YZF-□□	22.0 \pm 30%	0.5V / 10K	122	0.90
SSC0503270YZF-□□	27.0 \pm 30%	0.5V / 10K	175	0.85
SSC0503330YZF-□□	33.0 \pm 30%	0.5V / 10K	189	0.75
SSC0503390YZF-□□	39.0 \pm 30%	0.5V / 10K	212	0.70
SSC0503470YZF-□□	47.0 \pm 30%	0.5V / 10K	250	0.62
SSC0503560YZF-□□	56.0 \pm 30%	0.5V / 10K	305	0.58
SSC0503680YZF-□□	68.0 \pm 30%	0.5V / 10K	355	0.52
SSC0503820YZF-□□	82.0 \pm 30%	0.5V / 10K	463	0.46
SSC0503101YZF-□□	100.0 \pm 30%	0.5V / 10K	520	0.42



RoHS Compliant

NOTE : Specifications subject to change without notice. Please check our website for latest information.

04.10.2010



SUPERWORLD ELECTRONICS (S) PTE LTD

7. CHARACTERISTICS CURVES :

@ TEMP. RISE VS. DC SUPERPOSITION RESPONSE CURVE

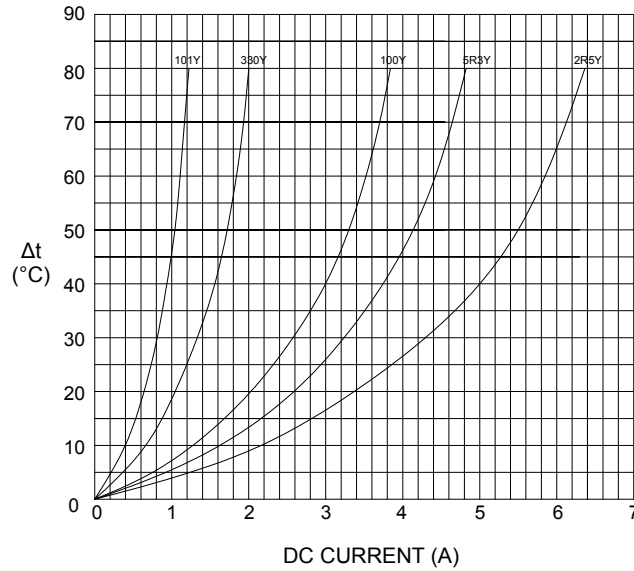

@ INDUCTANCE VS. FREQUENCY RESPONSE CURVE

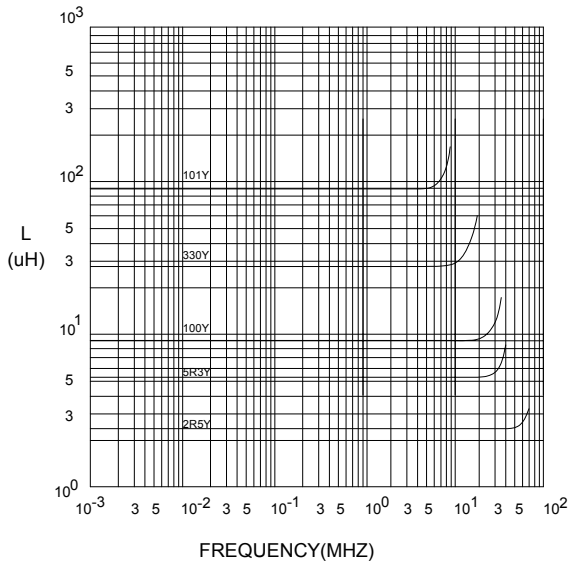

@ INDUCTANCE VS. DC SUPERPOSITION RESPONSE CURVE

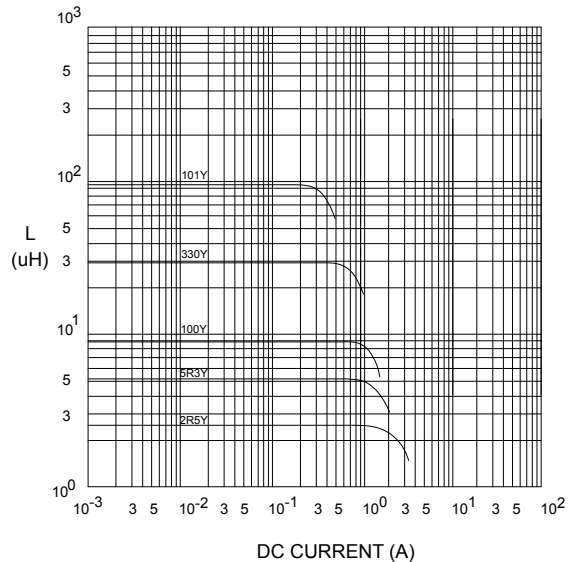

NOTE : Specifications subject to change without notice. Please check our website for latest information.



RoHS Compliant

04.10.2010



SUPERWORLD ELECTRONICS (S) PTE LTD

RECOMMENDED SOLDERING CONDITIONS REFLOW SOLDERINGS

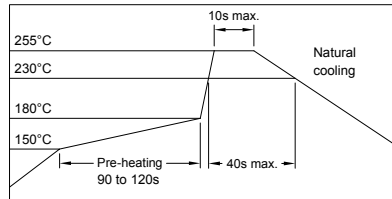

8. PACKAGING INFORMATION :

(1) CONFIGURATION

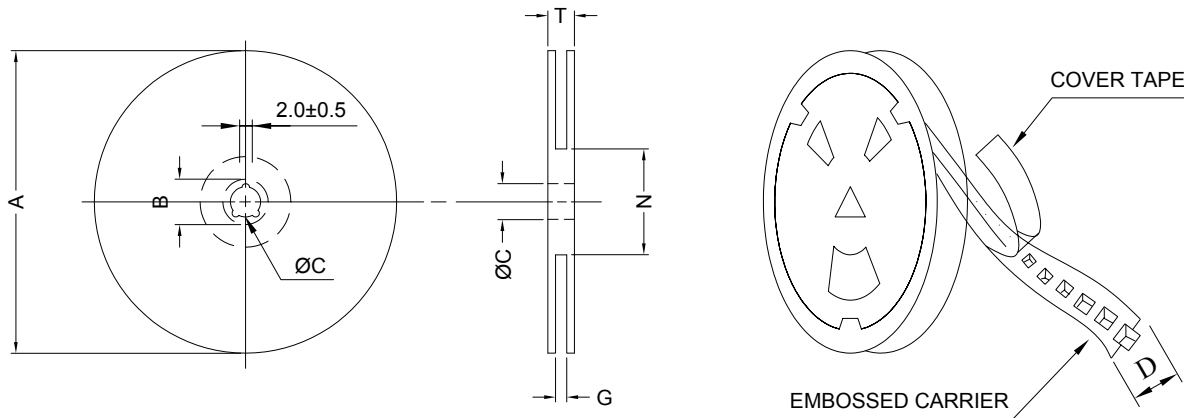

* CARRIER TAPE WIDTH : D

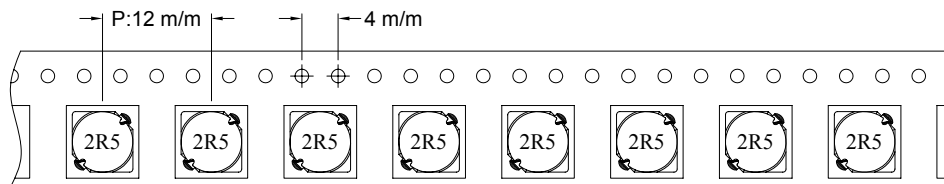

(2) DIMENSIONS

Unit:m/m

STYLE	A	B	C	D	G	N	T
13-16	330	21±0.8	13	16	18 ⁺⁰	50 ⁻⁰	22.4

(3) Q'TY & G.W. PER PACKAGE

SERIES	INNER : REEL			OUTER : CARTON		
	Q'TY (PCS)	G.W. (gw)	STYLE	Q'TY (PCS)	G.W. (Kg)	SIZE (cm)
SSC0503	1500	1800	13-16	9000	14.3	40 x 40 x 24



RoHS Compliant

NOTE : Specifications subject to change without notice. Please check our website for latest information.

04.10.2010



SUPERWORLD ELECTRONICS (S) PTE LTD

