

BCR2PM

LOW POWER USE
INSULATED TYPE, PLANAR PASSIVATION TYPE

BCR2PM



- IT (RMS) 2A
- VDRM 600V
- IRGT I, IRGT III 10mA

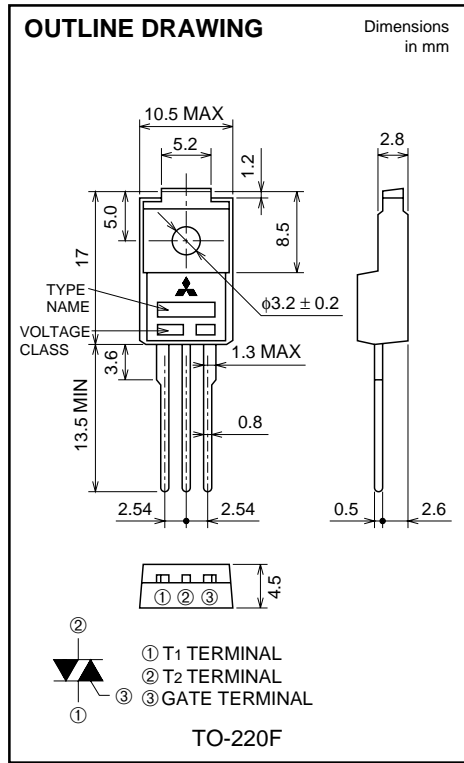

APPLICATION

Switching mode power supply, light dimmer, electric flasher unit, control of household equipment such as TV sets · stereo · refrigerator · washing machine · infrared kotatsu · carpet, solenoid drivers, small motor control, copying machine, electric tool, other general purpose control applications

MAXIMUM RATINGS

Symbol	Parameter	Voltage class		Unit
		12	600	
VDRM	Repetitive peak off-state voltage *1	600		V
VDSM	Non-repetitive peak off-state voltage *1	720		V

Symbol	Parameter	Conditions	Ratings	Unit
IT (RMS)	RMS on-state current	Commercial frequency, sine full wave 360° conduction	2	A
ITSM	Surge on-state current	60Hz sinewave 1 full cycle, peak value, non-repetitive	10	A
I ² _t	I ² _t for fusing	Value corresponding to 1 cycle of half wave 60Hz, surge on-state current	0.41	A ² s
PGM	Peak gate power dissipation		1	W
PG (AV)	Average gate power dissipation		0.1	W
VGM	Peak gate voltage		6	V
IGM	Peak gate current		1	A
T _j	Junction temperature		-40 ~ +125	°C
T _{stg}	Storage temperature		-40 ~ +125	°C
—	Weight	Typical value	2.0	g

*1. Gate open.

BCR2PM

LOW POWER USE

INSULATED TYPE, PLANAR PASSIVATION TYPE

ELECTRICAL CHARACTERISTICS

Symbol	Parameter	Test conditions	Limits			Unit
			Min.	Typ.	Max.	
IDRM	Repetitive peak off-state current	T _j =125°C, V _{DRM} applied	—	—	0.5	mA
V _{TM}	On-state voltage	T _a =25°C, I _{TM} =1.5A, Instantaneous measurement	—	—	1.6	V
V _{RGT I}	Gate trigger voltage *2	T _j =25°C, V _D =6V, R _L =6Ω, R _G =330Ω	—	—	2.0	V
V _{RGT III}			—	—	2.0	V
I _{RGT I}	Gate trigger current *2	T _j =25°C, V _D =6V, R _L =6Ω, R _G =330Ω	—	—	10	mA
I _{RGT III}			—	—	10	mA
V _{GD}	Gate non-trigger voltage	T _j =125°C, V _D =1/2V _{DRM}	0.1	—	—	V
R _{th(j-a)}	Thermal resistance	Junction to ambient, Natural convection	—	—	40	°C/W

*2. Measurement using the gate trigger characteristics measurement circuit.

GATE TRIGGER CHARACTERISTICS TEST CIRCUITS

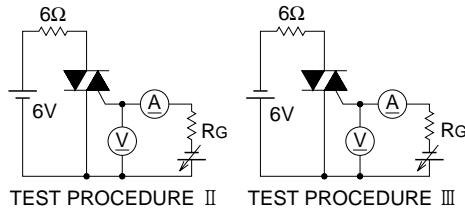

PERFORMANCE CURVES

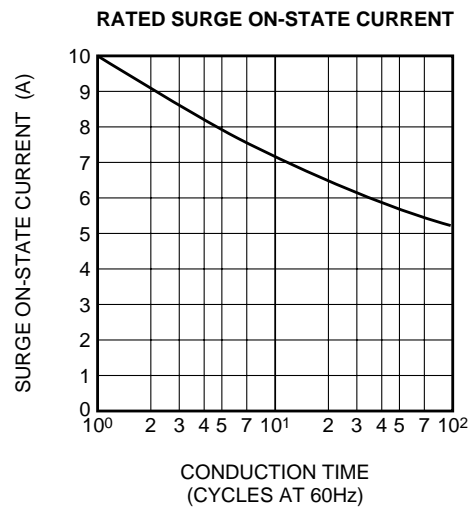
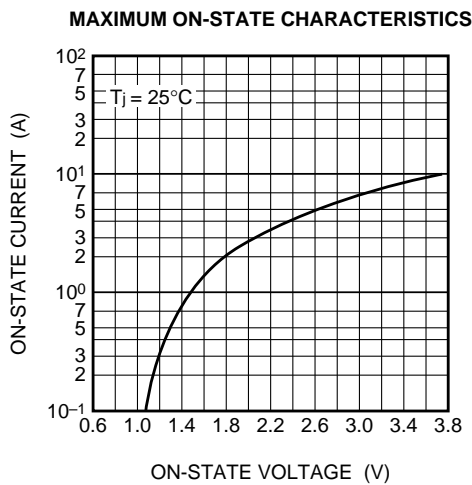

BCR2PM

LOW POWER USE
INSULATED TYPE, PLANAR PASSIVATION TYPE

GATE CHARACTERISTICS

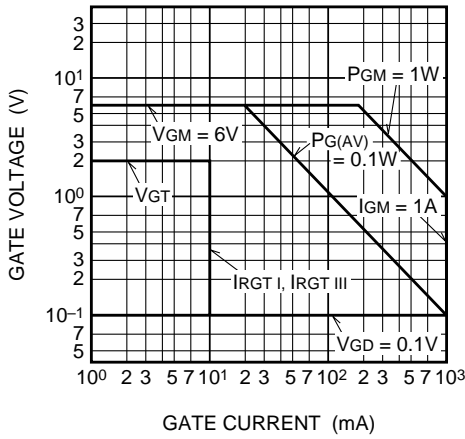

GATE TRIGGER CURRENT VS. JUNCTION TEMPERATURE

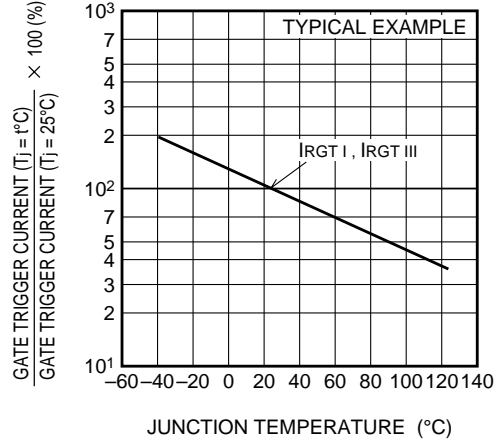

GATE TRIGGER VOLTAGE VS. JUNCTION TEMPERATURE

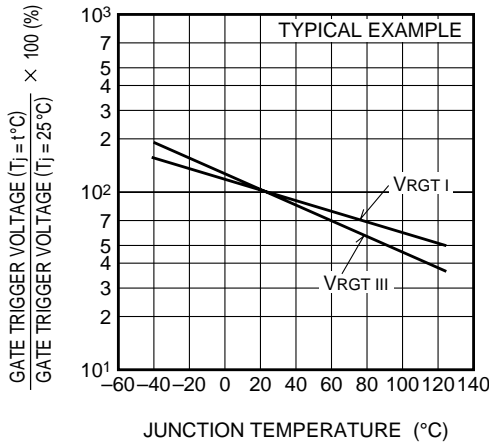

MAXIMUM TRANSIENT THERMAL IMPEDANCE CHARACTERISTICS (JUNCTION TO AMBIENT)

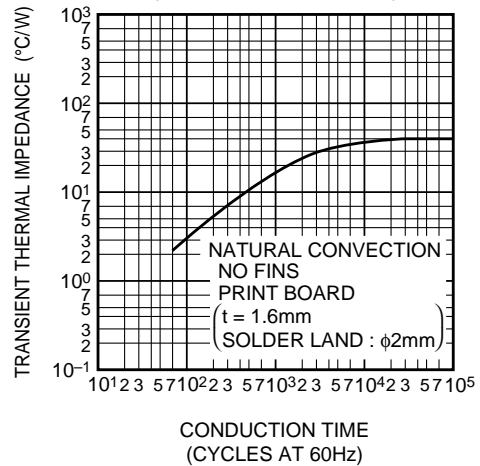

MAXIMUM ON-STATE POWER DISSIPATION

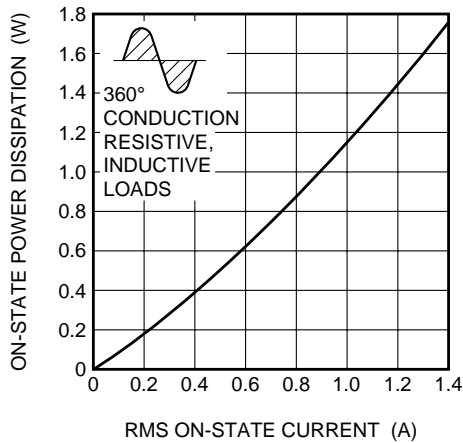

ALLOWABLE AMBIENT TEMPERATURE VS. RMS ON-STATE CURRENT

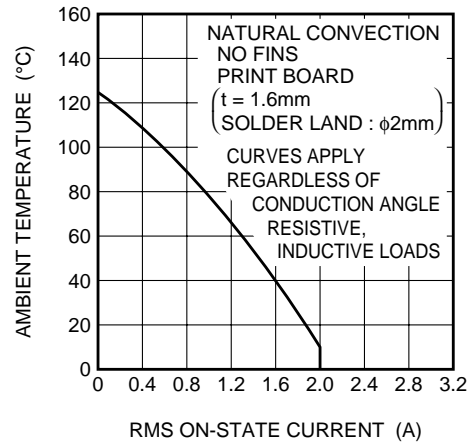

BCR2PM

LOW POWER USE
INSULATED TYPE, PLANAR PASSIVATION TYPE

