

## GaAs MMIC SOT26 SPDT SWITCH, DC - 3 GHz

### Typical Applications

The HMC221 is ideal for:

- ISM Applications
- PCMCIA Wireless Cards
- Cellular Applications

### Functional Diagram

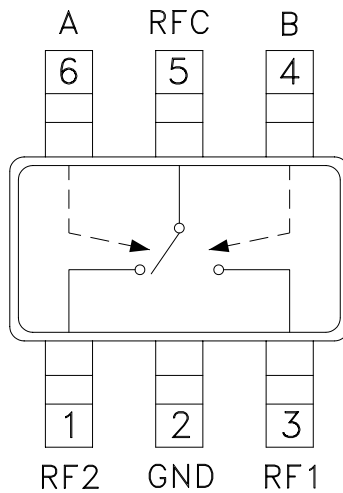

### Features

Low Insertion Loss: 0.4 dB

Ultra Small Package: SOT26

Input IP3: +45 dBm

Positive Control: 0/+3V @ 10 uA

### General Description

The HMC221 is a low-cost SPDT switch in a 6-lead SOT26 plastic package for use in general switching applications which require very low insertion loss and very small size. The device can control signals from DC to 3.0 GHz and is especially suited for 900 MHz, 1.8 - 2.2 GHz, and 2.4 GHz ISM applications with less than 1 dB loss. The design provides exceptional insertion loss performance, ideal for filter and receiver switching. RF1 and RF2 are reflective shorts when "Off". The two control voltages require a minimal amount of DC current and offer compatibility with most CMOS & TTL logic families. See HMC197 for same performance in an alternate SOT26 pin-out.

### Electrical Specifications, $T_A = +25^\circ C$ , $V_{ctl} = 0/+3$ to $+8 V_{dc}$

Parameter	Frequency	Min.	Typ.	Max.	Units
Insertion Loss	DC - 1.0 GHz		0.4	0.7	dB
	DC - 2.0 GHz		0.45	0.8	dB
	DC - 2.5 GHz		0.6	0.9	dB
	DC - 3.0 GHz		0.8	1.1	dB
Isolation	DC - 1.0 GHz	24	28		dB
	DC - 2.0 GHz	24	28		dB
	DC - 2.5 GHz	21	25		dB
	DC - 3.0 GHz	14	18		dB
Return Loss	DC - 1.0 GHz	20	23		dB
	DC - 2.0 GHz	17	22		dB
	DC - 2.5 GHz	16	20		dB
	DC - 3.0 GHz	11	15		dB
Input Power for 1 dB Compression ( $V_{ctl} = 0/+5V$ )	0.5 - 1.0 GHz	25	30		dBm
	0.5 - 3.0 GHz	23	29		dBm
Input Third Order Intercept ( $V_{ctl} = 0/+5V$ ) (Two-tone Input Power = +7 dBm Each Tone)	0.5 - 1.0 GHz	40	45		dBm
	0.5 - 3.0 GHz	38	43		dBm
Switching Characteristics	DC - 3.0 GHz				
		tRISE, tFALL (10/90% RF) tON, tOFF (50% CTL to 10/90% RF)		3 10	ns ns

## GaAs MMIC SOT26 SPDT SWITCH, DC - 3 GHz

**Insertion Loss**

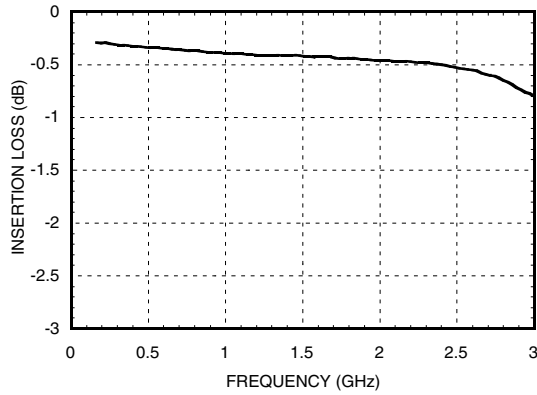

**Isolation**

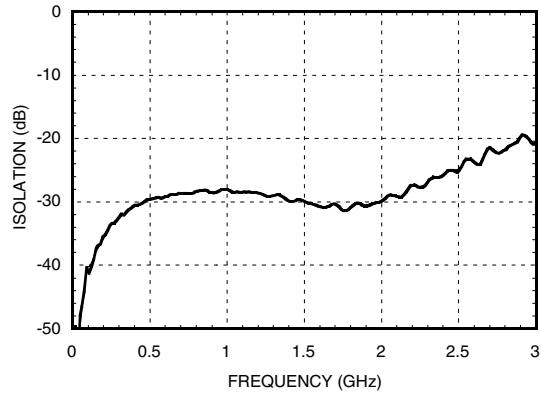

**Return Loss**

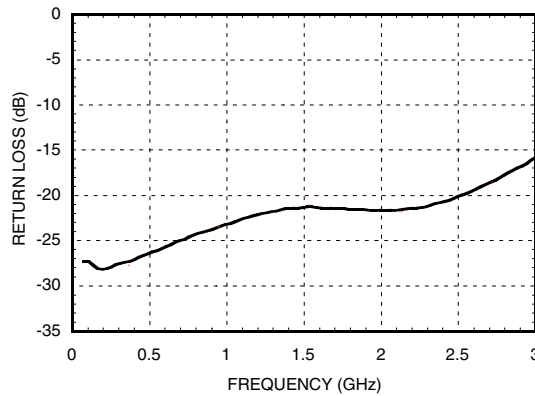

**Input 0.1 and 1.0 dB Compression vs. Control Voltage**

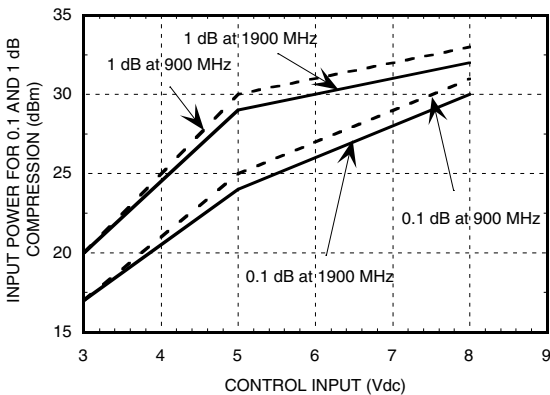

**Input Third Order Intercept Point vs. Control Voltage**

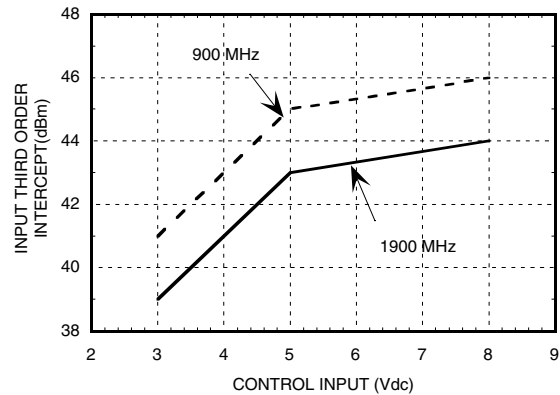

## GaAs MMIC SOT26 SPDT SWITCH, DC - 3 GHz

### Compression vs. Control Voltage

Control Input	Carrier at 900 MHz		Carrier at 1900 MHz	
	Input Power for 0.1 dB Compression	Input Power for 1.0 dB Compression	Input Power for 0.1 dB Compression	Input Power for 1.0 dB Compression
	(Vdc)	(dBm)	(dBm)	(dBm)
+3	17	20	17	20
+5	25	30	24	29
+8	31	33	30	32

Caution: Do not operate in 1dB compression at power levels above +31 dBm (Vctl = +5 Vdc) and do not "hot switch" power levels greater than +20 dBm (Vctl = +5Vdc).

DC blocks are required at ports RFC, RF1 and RF2.

### Distortion vs. Control Voltage

Control Input	Third Order Intercept (dBm) +7 dBm Each Tone	
	900 MHz	1900 MHz
+3	41	39
+5	45	43
+8	46	44

### Truth Table

\*Control Input Voltage Tolerances are  $\pm 0.2$  Vdc.

Control Input*		Control Current		Signal Path	
A (Vdc)	B (Vdc)	Ia ( $\mu$ A)	Ib ( $\mu$ A)	RF to RF1	RF to RF2
0	+3	-10	10	ON	OFF
+3	0	10	-10	OFF	ON
0	+5	-55	55	ON	OFF
+5	0	55	-55	OFF	ON
0	+7	-210	210	ON	OFF
+7	0	210	-210	OFF	ON
0	+8	-280	280	ON	OFF
+8	0	280	-280	OFF	ON

## GaAs MMIC SOT26 SPDT SWITCH, DC - 3 GHz

### Absolute Maximum Ratings

Control Voltage Range (A & B)	-0.2 to +12 Vdc
Storage Temperature	-65 to +150 °C
Operating Temperature	-40 to +85 °C

### Outline Drawing

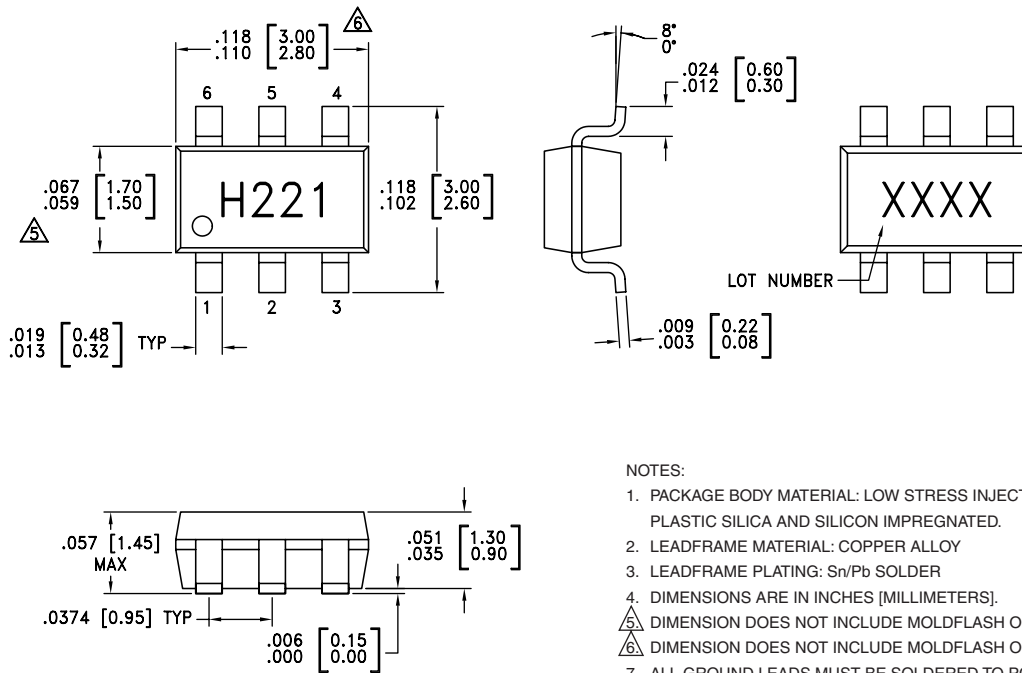

## GaAs MMIC SOT26 SPDT Switch , DC - 3 GHz

### Typical Application Circuit

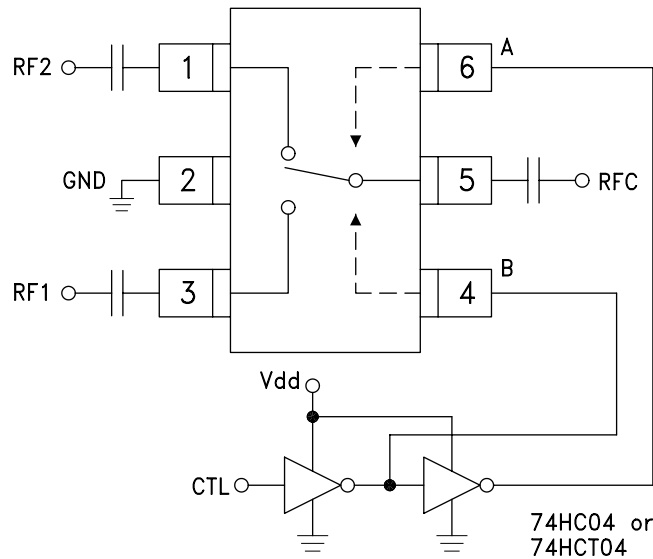

#### Notes:

1. Set logic gate and switch Vdd = +3V to +5V and use HCT series logic to provide a TTL driver interface.
2. Control inputs A/B can be driven directly with CMOS logic (HC) with Vdd of 5 to 8 Volts applied to the CMOS logic gates.
3. DC Blocking capacitors are required for each RF port as shown. Capacitor value determines lowest frequency of operation.
4. Highest RF signal power capability is achieved with Vdd = +8V and A/B set to 0/+8V.

### Evaluation Circuit Board

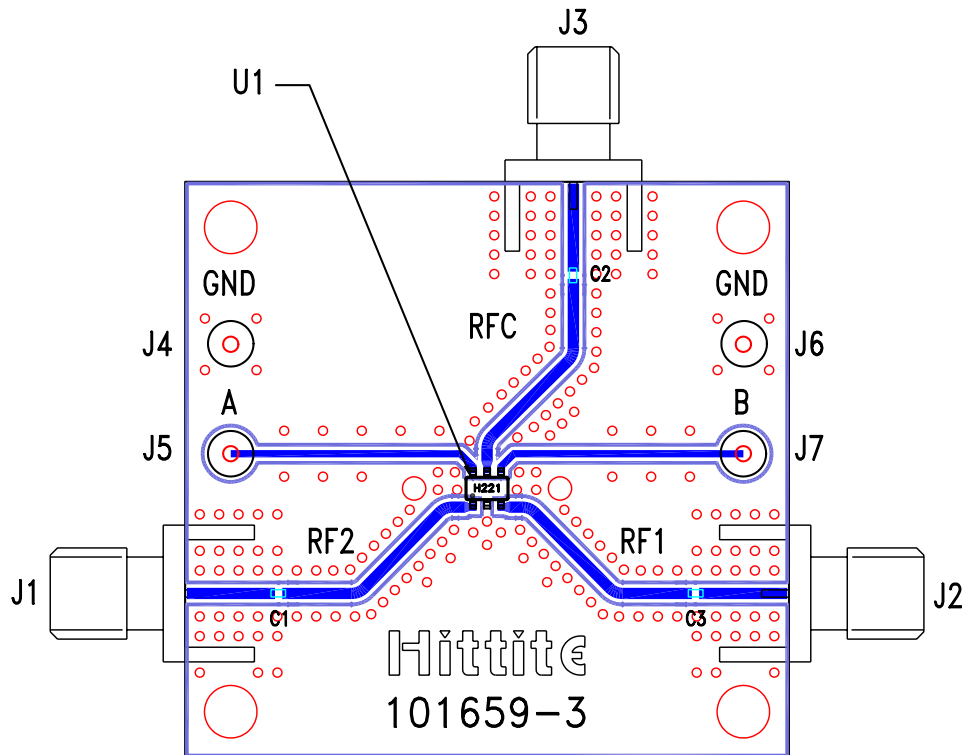

### List of Material

Item	Description
J1 - J3	PC Mount SMA RF Connector
J4 - J7	DC Pin
C1 - C3	330 pF capacitor, 0402 Pkg.
U1	HMC221 SPDT Switch
PCB*	101659 Evaluation PCB
* Circuit Board Material: Rogers 4350	

The circuit board used in the final application should be generated with proper RF circuit design techniques. Signal lines at the RF port should have 50 ohm impedance and the package ground leads and package bottom should be connected directly to the ground plane similar to that shown above. The evaluation circuit board shown above is available from Hittite Microwave Corporation upon request.