



MICROWAVE CORPORATION v03.0705



# HMC363S8G / 363S8GE

## SMT GaAs HBT MMIC DIVIDE-BY-8, DC - 12.0 GHz

### Typical Applications

Prescaler for DC to X Band PLL Applications:

- Satellite Communication Systems
- Fiber Optic
- Point-to-Point and Point-to-Multi-Point Radios
- VSAT

### Features

- Ultra Low SSB Phase Noise: -153 dBc/Hz
- Wide Bandwidth
- Output Power: -6 dBm
- Single DC Supply: +5V
- S8G SMT Package

### Functional Diagram

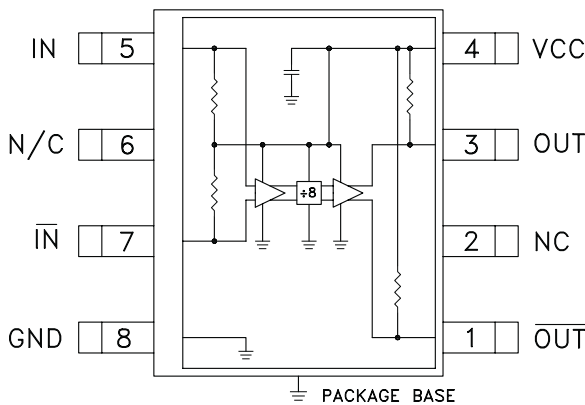

### General Description

The HMC363S8G & HMC363S8GE are low noise Divide-by-8 Static Dividers with InGaP GaAs HBT technology in 8 lead surface mount plastic packages. This device operates from DC (with a square wave input) to 12 GHz input frequency with a single +5.0V DC supply. The low additive SSB phase noise of -153 dBc/Hz at 100 kHz offset helps the user maintain good system noise performance.

### Electrical Specifications, $T_A = +25^\circ C$ , 50 Ohm System, $V_{cc} = 5V$

Parameter	Conditions	Min.	Typ.	Max.	Units
Maximum Input Frequency		12	13		GHz
Minimum Input Frequency	Sine Wave Input. [1]		0.2	0.5	GHz
Input Power Range	$F_{in} = 1$ to 7 GHz	-15	>-20	+10	dBm
	$F_{in} = 7$ to 11 GHz	-10	>-15	+2	dBm
	$F_{in} = 11$ to 12 GHz	-5	>-8	0	dBm
Output Power	$F_{in} = 12$ GHz	-9	-6		dBm
Reverse Leakage	Both RF Outputs Terminated		65		dB
SSB Phase Noise (100 kHz offset)	$P_{in} = 0$ dBm, $F_{in} = 6$ GHz		-153		dBc/Hz
Output Transition Time	$P_{in} = 0$ dBm, $F_{out} = 882$ MHz		100		ps
Supply Current ( $I_{cc}$ )			70		mA

1. Divider will operate down to DC for square-wave input signal.



**HMC363S8G / 363S8GE**

**SMT GaAs HBT MMIC  
DIVIDE-BY-8, DC - 12.0 GHz**

**Input Sensitivity Window, T= 25 °C**

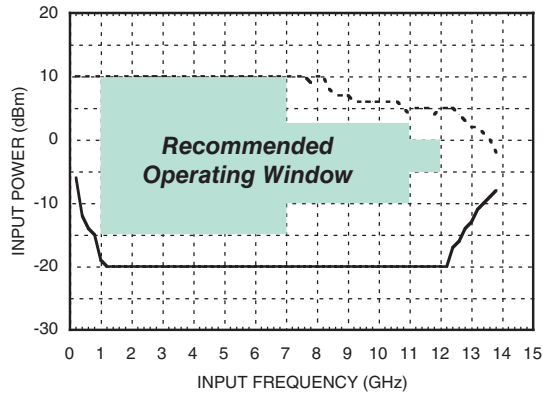

**Input Sensitivity Window vs. Temperature**

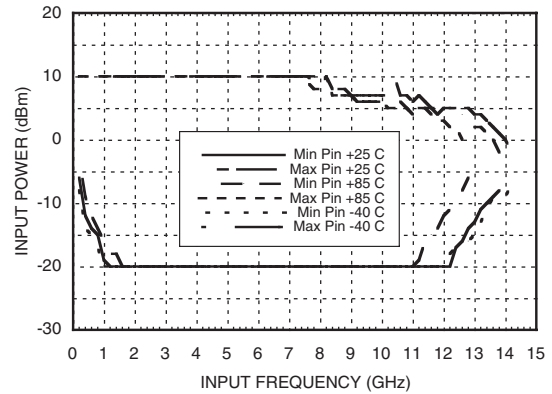

**Output Power vs. Temperature**

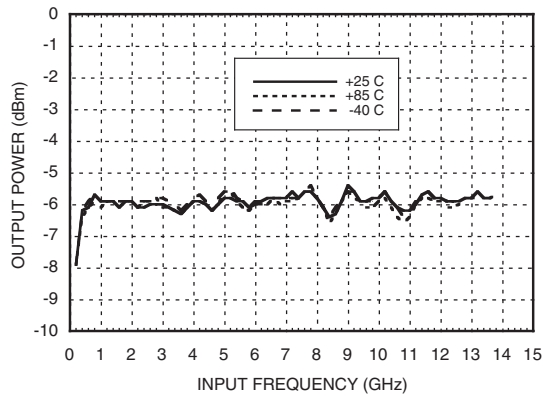

**SSB Phase Noise Performance, Pin= 0 dBm, T= 25 °C**

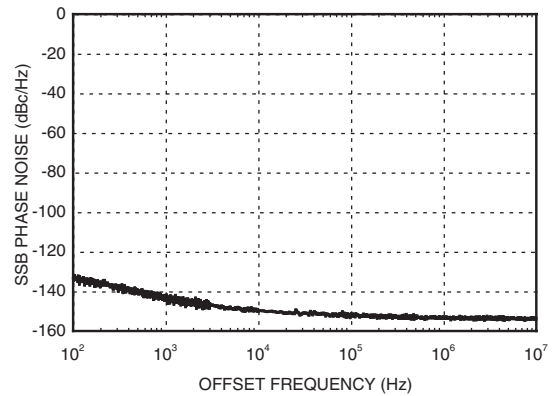

**Output Harmonic Content, Pin= 0 dBm, T= 25 °C**

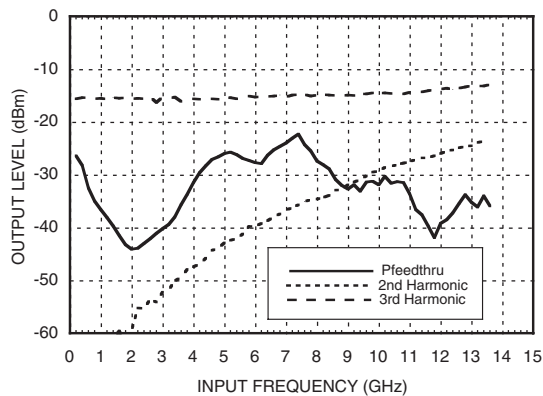

**Reverse Leakage, Pin= 0 dBm, T= 25 °C**

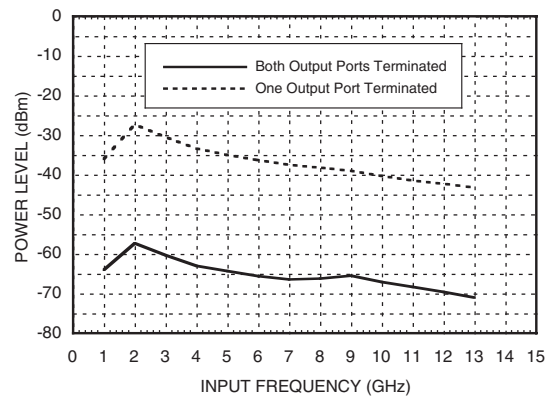



# HMC363S8G / 363S8GE

## SMT GaAs HBT MMIC DIVIDE-BY-8, DC - 12.0 GHz

**Output Voltage Waveform,**  
Pin= 0 dBm, Fout= 882 MHz, T= 25 °C

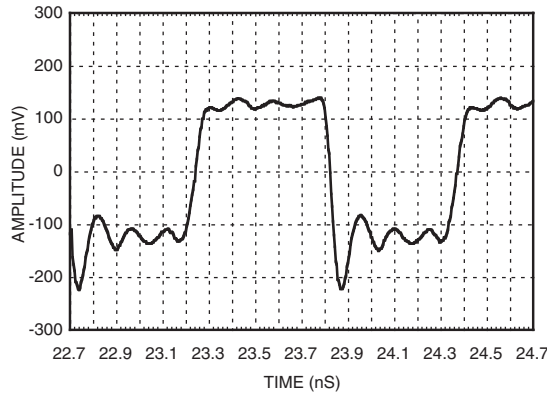

### Absolute Maximum Ratings

RF Input (Vcc = +5V)	+13 dBm
Vcc	+5.5V
VLogic	Vcc -1.6V to Vcc -1.2V
Storage Temperature	-65 to +150 °C
Operating Temperature	-40 to +85 °C

### Typical Supply Current vs. Vcc

Vcc (V)	Icc (mA)
4.75	64
5.0	70
5.25	75

Note: Divider will operate over full voltage range shown above



**ELECTROSTATIC SENSITIVE DEVICE  
OBSERVE HANDLING PRECAUTIONS**

### Outline Drawing

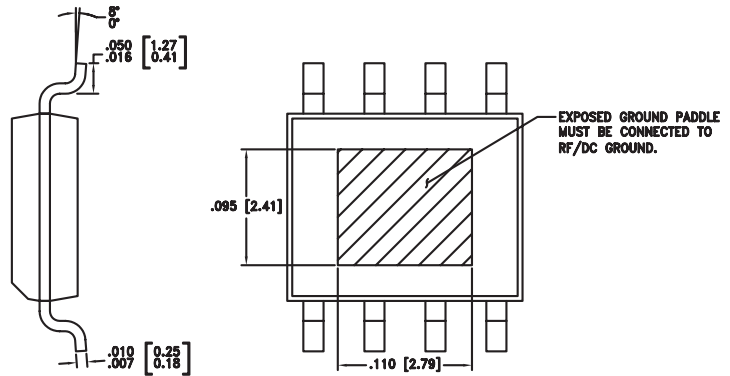
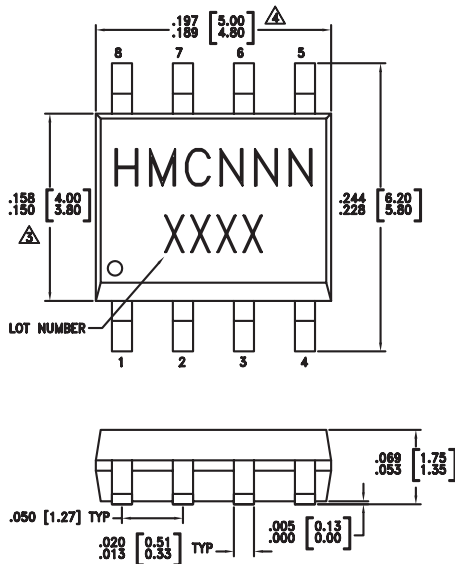

**NOTES:**

- LEADFRAME MATERIAL: COPPER ALLOY
- DIMENSIONS ARE IN INCHES [MILLIMETERS]
- DIMENSION DOES NOT INCLUDE MOLDFLASH OF 0.15mm PER SIDE.
- DIMENSION DOES NOT INCLUDE MOLDFLASH OF 0.25mm PER SIDE.
- ALL GROUND LEADS AND GROUND PADDLE MUST BE SOLDERED TO PCB RF GROUND.

### Package Information



Part Number	Package Body Material	Lead Finish	MSL Rating	Package Marking <sup>[3]</sup>
HMC363S8G	Low Stress Injection Molded Plastic	Sn/Pb Solder	MSL1 <sup>[1]</sup>	HMC363 XXXX
HMC363S8GE	RoHS-compliant Low Stress Injection Molded Plastic	100% matte Sn	MSL1 <sup>[2]</sup>	HMC363 XXXX

[1] Max peak reflow temperature of 235 °C

[2] Max peak reflow temperature of 260 °C

[3] 4-Digit lot number XXXX

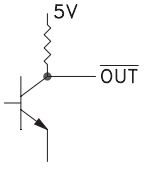
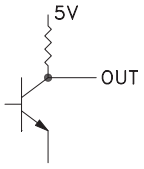
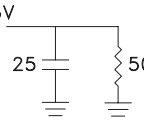
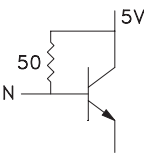
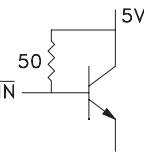
## Pin Description

Pin Number	Function	Description	Interface Schematic
1	$\overline{\text{OUT}}$	Divided output 180° out of phase with pin 3.	
2, 6	N/C	No connection. These pins must not be grounded.	
3	OUT	Divided Output.	
4	VCC	Supply voltage 5V ± 0.25V.	
5	IN	RF Input must be DC blocked.	
7	$\overline{\text{IN}}$	RF Input 180° out of phase with pin 5 for differential operation. A/C ground for single ended operation	
8	GND	Ground Backside of package has exposed metal ground slug which must be connected to ground.	



MICROWAVE CORPORATION v03.0705



# HMC363S8G / 363S8GE

SMT GaAs HBT MMIC  
DIVIDE-BY-8, DC - 12.0 GHz

## Evaluation PCB

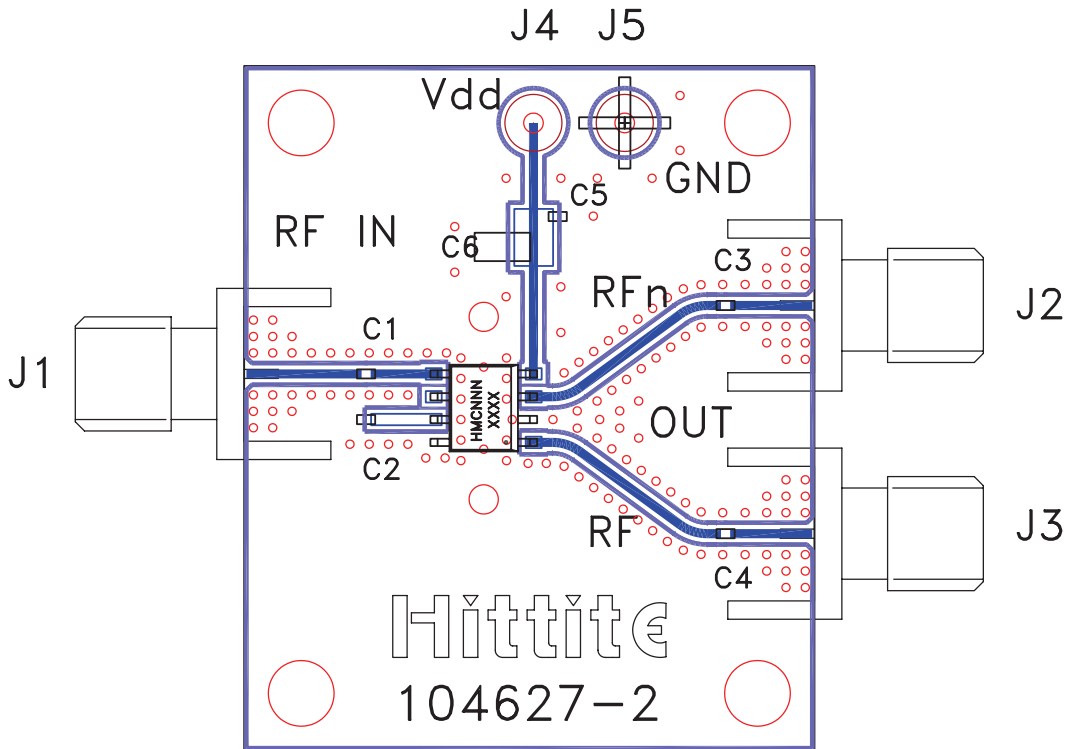

### List of Materials for Evaluation PCB 104631 [1]

Item	Description
J1 - J3	PCB Mount SMA RF Connector
C1 - C4	100 pF Capacitor, 0402 Pkg.
C5	1000 pF Capacitor, 0603 Pkg.
C6	10 μF Tantalum Capacitor
U1	HMC363S8G / HMC363S8GE Divide-by-8
PCB [2]	104627 Eval Board

[1] Reference this number when ordering complete evaluation PCB

[2] Circuit Board Material: Rogers 4350

The circuit board used in the final application should use RF circuit design techniques. Signal lines should have 50 ohm impedance while the package ground leads and backside ground slug should be connected directly to the ground plane similar to that shown. A sufficient number of via holes should be used to connect the top and bottom ground planes. The evaluation circuit board shown is available from Hittite upon request. This evaluation board is designed for single ended input testing. J2 and J3 provide differential output signals.



MICROWAVE CORPORATION v03.0705



# HMC363S8G / 363S8GE

SMT GaAs HBT MMIC  
DIVIDE-BY-8, DC - 12.0 GHz

## Application Circuit

