

4855452 INTERNATIONAL RECTIFIER

55C 05195 D

T-25-23

Data Sheet No. PD-4.001C

INTERNATIONAL RECTIFIER 

P100, PR100 SERIES

Passivated Assembled Circuit Elements

Major ratings and characteristics

	P(R) 100	Units
I_O	25	A
I_{TSM}	50Hz	357 A
	60Hz	375 A
i^2t	50Hz	637 A^2s
	60Hz	580 A^2s
$I^2\sqrt{t}$	6365	$A^2\sqrt{s}$
V_{RRM}	400 to 1200	V
V_{INS}	2500	V
T_J	-40 to 125	$^{\circ}C$

Description

The P100 series of Integrated Power Circuits consists of power thyristors and power diodes configured in a single package. With its isolating base plate mechanical designs are greatly simplified giving advantages of cost reduction and reduced size. Applications include power supplies, control circuits and battery chargers.

Features

- Glass passivated junctions for greater reliability
- Electrically isolated base plate
- Available up to 1200V V_{RRM} , V_{DRM}
- High dynamic Characteristics.
- Available with screw terminals as "PR" series.

D

CASE STYLE AND DIMENSIONS

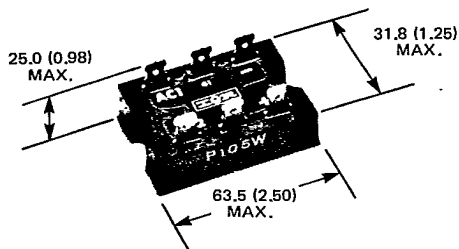

"P" Outline

See page D-52 for PR outline

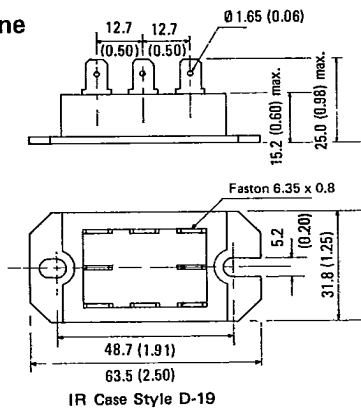

IR Case Style D-19

All dimensions in mm (inches)

4855452 INTERNATIONAL RECTIFIER

55C 05196 D

P100, PR100 Series

INTERNATIONAL RECTIFIER 

ELECTRICAL SPECIFICATIONS

Voltage ratings

T-25-23

Type number	V_{RRM} , maximum repetitive peak reverse voltage $V_g \leq 0$	V_{RSM} , maximum non-repetitive peak reverse voltage	V_{DRM} , maximum repetitive peak off-state voltage, gate open circuit
	V	V	V
P(R)101, P(R)111, P(R)121, P(R)131, P(R)141, P(R)161, P(R)171	400	500	400
P(R)102, P(R)112, P(R)122, P(R)132, P(R)142, P(R)162, P(R)172	600	700	600
P(R)103, P(R)113, P(R)123, P(R)133, P(R)143, P(R)163, P(R)173	800	900	800
P(R)104, P(R)114, P(R)124, P(R)134, P(R)144, P(R)164, P(R)174	1000	1100	1000
P(R)105, P(R)115, P(R)125, P(R)135, P(R)145, P(R)165, P(R)175	1200	1300	1200

Forward conduction

		P(R)100 Series	Units	Conditions
I_C	Maximum DC output current	25	A	$T_c = 85^\circ\text{C}$, full bridge circuits 0, 1, 2 and 3
$I_{T(AV)}$ $I_{F(AV)}$	Maximum average on-state and forward current	12.5	A	180° sine wave conduction circuits 0, 1, 2, 3, 4, 6 and 7
I_{RMS}	Maximum RMS current	28	A	180° sine wave conduction circuit 4
I_{TSM} OR I_{FSM}	Maximum peak, one-cycle non-repetitive on-state or forward current	300	A	10ms 100% V_{RRM}
		315	A	8.3ms reapplied
		357	A	10ms No voltage
		375	A	8.3ms reapplied
I^2t	Maximum I^2t for fusing	450	A^2s	10ms 100% V_{RRM}
		410	A^2s	8.3ms reapplied
		637	A^2s	10ms No voltage
		580	A^2s	8.3ms reapplied
$I^2\sqrt{t}$	Maximum $I^2\sqrt{t}$ for fusing ^①	6365	$\text{A}^2\sqrt{\text{s}}$	$t = 0.1$ to 10ms, no voltage reapplied
$V_{T(TO)}$	Maximum value of threshold voltage	0.82	V	$T_J = 125^\circ\text{C}$
$r_{\theta T}$	Maximum value of on-state slope resistance	12	m Ω	$T_J = 125^\circ\text{C}$
V_{TM} V_{FM}	Maximum peak on-state or forward voltage	1.35	V	$I_{TM} = \pi \times I_{T(AV)}$
		1.35	V	$I_{FM} = \pi \times I_{F(AV)}$
di/dt	Maximum non-repetitive rate of rise of current	200	A/ μs	$T_J = 125^\circ\text{C}$, from 0.67 V_{DRM} , $I_{TM} = \pi \times I_{T(AV)}$, $I_g = 500\text{mA}$, $t_r < 0.5 \mu\text{s}$, $t_p > 6 \mu\text{s}$
I_H	Maximum holding current	100	mA	$T_J = 25^\circ\text{C}$, anode supply = 6V, resistive load, gate open circuit
I_L	Maximum latching current	250	mA	$T_J = 25^\circ\text{C}$, anode supply = 6V, resistive load

Triggering

P_{GM}	Maximum peak gate power	8.0	W	
$P_{G(AV)}$	Maximum average gate power	2.0	W	
I_{GM}	Maximum peak gate current	2.0	A	
$-V_{GM}$	Maximum peak negative gate voltage	10	V	
V_{GT}	Maximum gate voltage required to trigger	3.0	V	$T_J = -40^\circ\text{C}$
		2.0	V	$T_J = 25^\circ\text{C}$
		1.0	V	$T_J = 125^\circ\text{C}$
I_{GT}	Maximum gate current required to trigger	90	mA	$T_J = -40^\circ\text{C}$
		60	mA	$T_J = 25^\circ\text{C}$
		35	mA	$T_J = 125^\circ\text{C}$
V_{GD}	Maximum gate voltage that will not trigger	0.2	V	$T_J = 125^\circ\text{C}$, rated V_{DRM} applied
I_{GD}	Maximum gate current that will not trigger.		mA	

Blocking

dv/dt	Maximum critical rate of rise of off-state voltage	200	V/ μs	$T_J = 125^\circ\text{C}$, exponential to 0.67 V_{DRM} , gate open circuit
I_{RM} I_{DM}	Maximum peak reverse and off-state leakage current at V_{RRM} , V_{DRM}	10	mA	$T_J = T_J \text{ max}$, gate open circuit
V_{INS}	RMS isolation voltage	2500	V	50Hz, circuit to base, all terminals shorted

① I^2t for time $t_x = I^2 \sqrt{t} \cdot \sqrt{t_x}$.

D-48

4855452 INTERNATIONAL RECTIFIER

55C 05197 D



P100, PR100 Series

T-25-23

THERMAL AND MECHANICAL SPECIFICATIONS

	P(R)100 Series	Units	Conditions
T _J	Junction operating temperature range	-40 to 125	°C
T _{stg}	Storage temperature range	-40 to 150	°C
R _{thJC}	Maximum internal thermal resistance, one junction to case	2.24	K/W DC Operation
R _{thCS}	Maximum thermal resistance, base to heatsink	0.10	K/W Mounting surface smooth and greased
T	Mounting torque, base to heatsink ± 10%	5	Nm A mounting compound is recommended and the torque should be checked after a period of about 3 hrs to allow for the spread of the compound.
wt	Approximate weight	P100	58 (2.0) g (oz)
		PR100	90 (3.2) g (oz)

CIRCUIT TYPES AND CODING*

	Circuit "0"	Circuit "1"	Circuit "2"	Circuit "3"	Circuit "4"	Circuit "6"	Circuit "7"
Terminal Positions							
Schematic Diagram							
	Single Phase, Hybrid Bridge, Common Cathode	Single Phase, Hybrid Bridge, Common Anode	Single Phase Hybrid Bridge, Doubler Connection	Single Phase, All SCR Bridge	SCR AC Switch	Hybrid Doubler	SCR Doubler
Basic series	P(R)10_*	P(R)11_*	P(R)12_*	P(R)13_*	P(R)14_*	P(R)16_*	P(R)17_*
With voltage suppression	P(R)10_K	P(R)11_K	P(R)12_K	P(R)13_K	P(R)14_K	-	-
With free-wheeling diode	P(R)10_W	P(R)11_W	-	-	-	-	-
With both voltage suppression and free-wheeling diode	P(R)10_KW	P(R)11_KW	-	-	-	-	-

*To complete code refer to voltage ratings table, i.e. for 600V P(R)10_KW complete code is P102KW.



4855452 INTERNATIONAL RECTIFIER

55C 05198 D

P100, PR100 Series

INTERNATIONAL RECTIFIER 

T-25-23

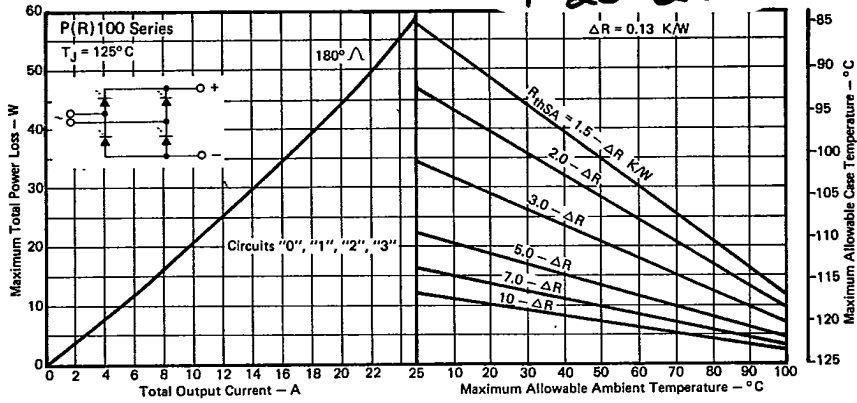

Fig. 1 - Current Rating Nomogram (1 Module Per Heatsink), Circuits '0', '1', '2', '3'

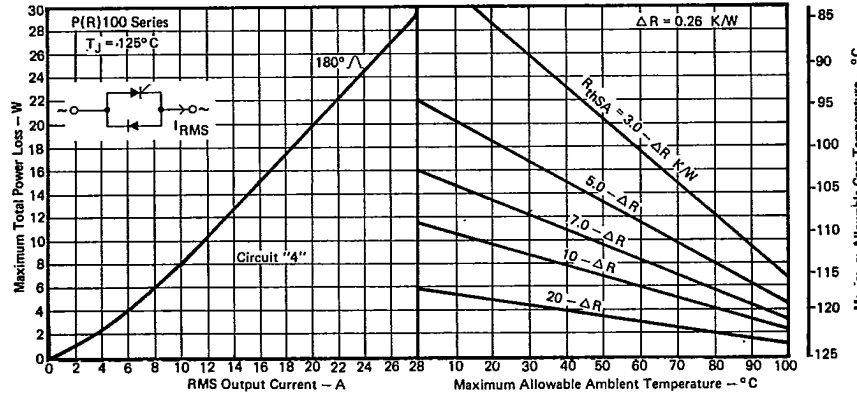

Fig. 2 - Current Rating Nomogram (1 Module Per Heatsink), Circuit '4'

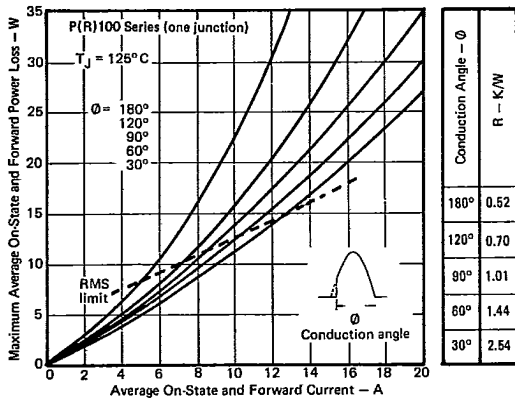

Fig. 3 - Maximum On-State and Forward Power Loss Vs. On-State and Forward Current (Sinusoidal Current Waveform)

D-50

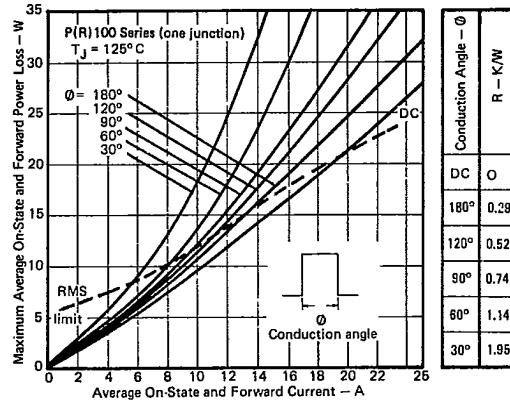

Fig. 4 - Maximum On-State and Forward Power Loss Vs. On-State and Forward Current (Rectangular Current Waveform)

4855452 INTERNATIONAL RECTIFIER

55C 05199 D

IR INTERNATIONAL RECTIFIER

T-25-23

P100, PR100 Series

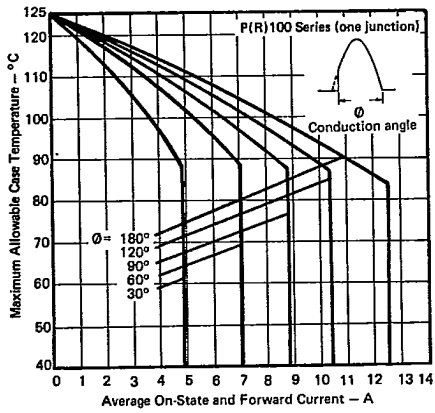

Fig. 5 - Average On-State and Forward Current Vs. Maximum Allowable Case Temperature (Sinusoidal Current Waveform)

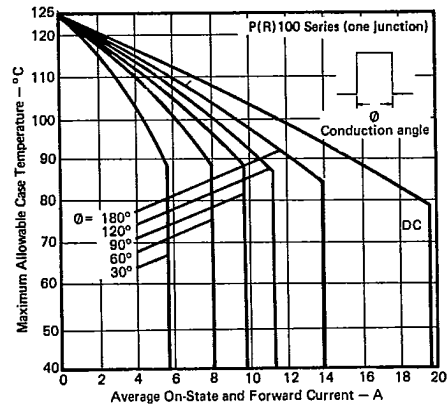

Fig. 6 - Average On-State and Forward Current Vs. Maximum Allowable Case Temperature (Rectangular Current Waveform)

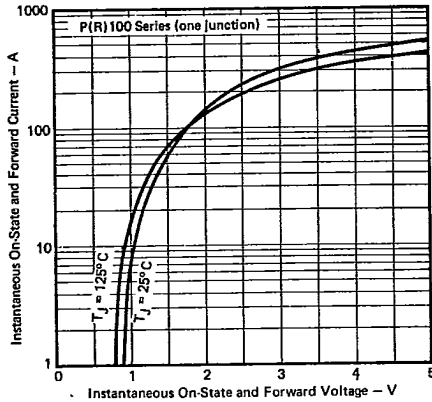

Fig. 7 - Maximum On-State and Forward Voltage Vs. On-State and Forward Current

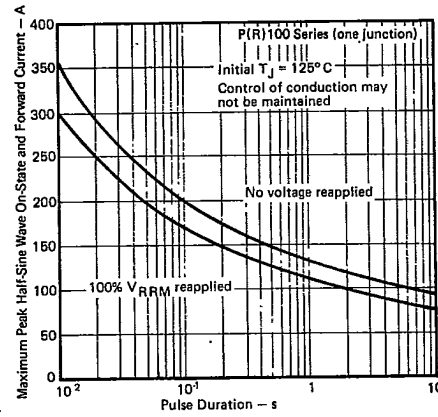

Fig. 8 - Maximum Non-Repetitive Surge Current Vs. Pulse Duration

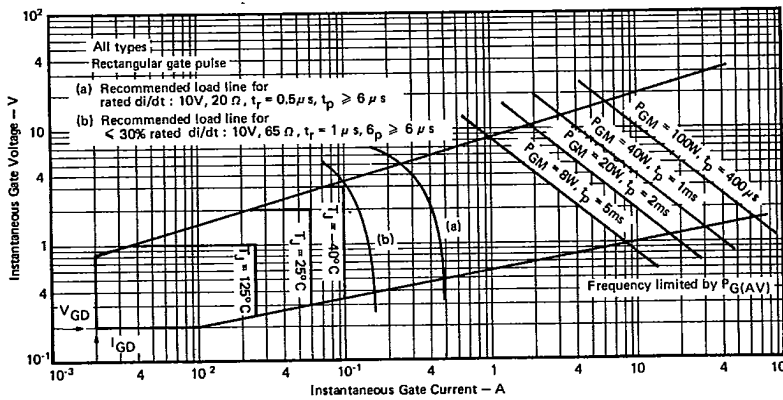

Fig. 9 - Gate Characteristics / Fig. 10 - Area of All Possible Triggering Points

D

4855452 INTERNATIONAL RECTIFIER

55C 05200 D

P100, PR100 Series

INTERNATIONAL RECTIFIER **IR**

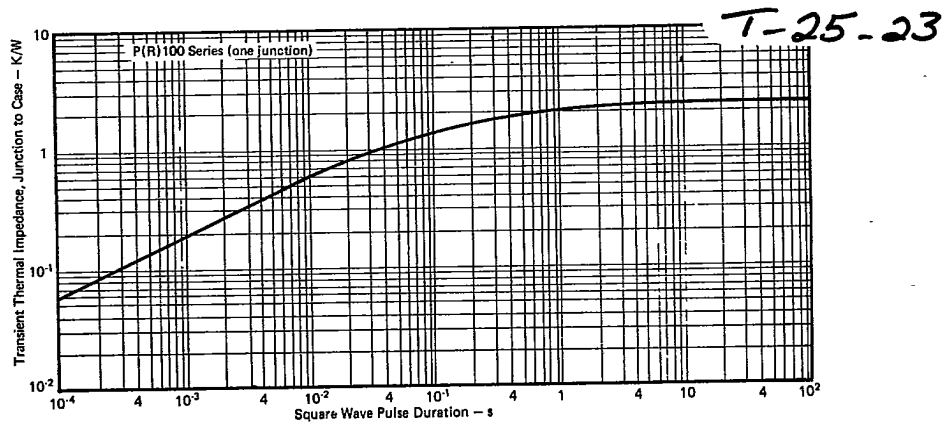

Fig. 11 - Maximum Transient Thermal Impedance, One-Junction-to-Case Vs. Pulse Duration

