

## Sideview LED, 5 mm Tinted Diffused

### Features

- Even luminance of the emitting surface
- Wide viewing angle
- Yellow and green color categorized
- For DC and pulse operation

### Applications

Indicating and illumination purposes

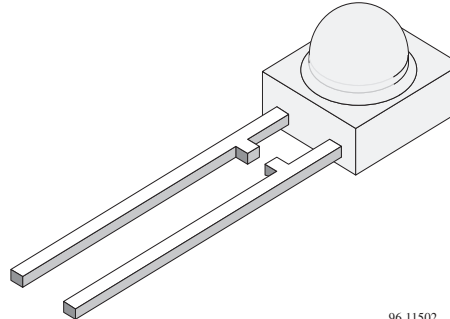

96 11502

### Parts Table

Part	Color, Luminous Intensity	Angle of Half Intensity ( $\pm\phi$ )	Technology
TLPR5600	Red, $I_V > 1$ mcd	80	GaAsP on GaAs
TLPH5600	High eff. red, $I_V > 0.63$ mcd	80	GaAsP on GaP
TLPY5600	Yellow, $I_V > 0.63$ mcd	80	GaAsP on GaP
TLPG5600	Green, $I_V > 0.63$ mcd	80	GaP on GaP
TLPP5600	Pure green, $I_V > 0.63$ mcd	80	GaP on GaP

### Absolute Maximum Ratings

$T_{amb} = 25^\circ\text{C}$ , unless otherwise specified

TLPR5600, TLPH5600, TLPY5600, TLPG5600, TLPP5600

Parameter	Test condition	Part	Symbol	Value	Unit
Reverse voltage			$V_R$	6	V
DC forward current		TLPR5600	$I_F$	20	mA
		TLPH5600	$I_F$	30	mA
		TLPY5600	$I_F$	30	mA
		TLPG5600	$I_F$	30	mA
		TLPP5600	$I_F$	30	mA
Surge forward current	$t_p \leq 10 \mu\text{s}$		$I_{FSM}$	1	A
Power dissipation		TLPR5600	$P_V$	60	mW
	$T_{amb} \leq 60^\circ\text{C}$	TLPH5600	$P_V$	100	mW
	$T_{amb} \leq 60^\circ\text{C}$	TLPY5600	$P_V$	100	mW
	$T_{amb} \leq 60^\circ\text{C}$	TLPG5600	$P_V$	100	mW
	$T_{amb} \leq 60^\circ\text{C}$	TLPP5600	$P_V$	100	mW
Junction temperature			$T_j$	100	$^\circ\text{C}$
Operating temperature range			$T_{amb}$	- 40 to + 100	$^\circ\text{C}$
Storage temperature range			$T_{stg}$	- 55 to + 100	$^\circ\text{C}$
Soldering temperature	$t \leq 5$ s, 2 mm from body		$T_{sd}$	260	$^\circ\text{C}$

Parameter	Test condition	Part	Symbol	Value	Unit
Thermal resistance junction/ ambient		TLPR5600	$R_{thJA}$	500	K/W
		TLPH5600	$R_{thJA}$	400	K/W
		TLPY5600	$R_{thJA}$	400	K/W
		TLPG5600	$R_{thJA}$	400	K/W
		TLPP5600	$R_{thJA}$	400	K/W

## Optical and Electrical Characteristics

$T_{amb} = 25\text{ }^{\circ}\text{C}$ , unless otherwise specified

### Red

#### TLPR5600

Parameter	Test condition	Part	Symbol	Min	Typ.	Max	Unit
Luminous intensity <sup>1)</sup>	$I_F = 10\text{ mA}$		$I_V$	1	2.5		mcd
Dominant wavelength	$I_F = 10\text{ mA}$		$\lambda_d$		630		nm
Peak wavelength	$I_F = 10\text{ mA}$		$\lambda_p$		640		nm
Angle of half intensity	$I_F = 10\text{ mA}$		$\phi$		$\pm 80$		deg
Forward voltage	$I_F = 20\text{ mA}$		$V_F$		2	3	V
Reverse voltage	$I_R = 10\text{ }\mu\text{A}$		$V_R$	6	15		V
Junction capacitance	$V_R = 0, f = 1\text{ MHz}$		$C_j$		50		pF

<sup>1)</sup> in one Packing Unit  $I_{VMin.}/I_{VMax.} \leq 0.5$

### High efficiency red

#### TLPH5600

Parameter	Test condition	Part	Symbol	Min	Typ.	Max	Unit
Luminous intensity <sup>1)</sup>	$I_F = 10\text{ mA}$		$I_V$	0.63	1.5		mcd
Dominant wavelength	$I_F = 10\text{ mA}$		$\lambda_d$	612		625	nm
Peak wavelength	$I_F = 10\text{ mA}$		$\lambda_p$		635		nm
Angle of half intensity	$I_F = 10\text{ mA}$		$\phi$		$\pm 80$		deg
Forward voltage	$I_F = 20\text{ mA}$		$V_F$		2	3	V
Reverse voltage	$I_R = 10\text{ }\mu\text{A}$		$V_R$	6	15		V
Junction capacitance	$V_R = 0, f = 1\text{ MHz}$		$C_j$		50		pF

<sup>1)</sup> in one Packing Unit  $I_{VMin.}/I_{VMax.} \leq 0.5$

### Yellow

#### TLPY5600

Parameter	Test condition	Part	Symbol	Min	Typ.	Max	Unit
Luminous intensity <sup>1)</sup>	$I_F = 10\text{ mA}$		$I_V$	0.63	1.5		mcd
Dominant wavelength	$I_F = 10\text{ mA}$		$\lambda_d$	581		594	nm
Peak wavelength	$I_F = 10\text{ mA}$		$\lambda_p$		585		nm
Angle of half intensity	$I_F = 10\text{ mA}$		$\phi$		$\pm 80$		deg
Forward voltage	$I_F = 20\text{ mA}$		$V_F$		2.4	3	V
Reverse voltage	$I_R = 10\text{ }\mu\text{A}$		$V_R$	6	15		V
Junction capacitance	$V_R = 0, f = 1\text{ MHz}$		$C_j$		50		pF

<sup>1)</sup> in one Packing Unit  $I_{VMin.}/I_{VMax.} \leq 0.5$

### Green

Parameter	Test condition	Part	Symbol	Min	Typ.	Max	Unit
Luminous intensity <sup>1)</sup>	$I_F = 10 \text{ mA}$		$I_V$	0.63	1.5		mcd
Dominant wavelength	$I_F = 10 \text{ mA}$		$\lambda_d$	562		575	nm
Peak wavelength	$I_F = 10 \text{ mA}$		$\lambda_p$		565		nm
Angle of half intensity	$I_F = 10 \text{ mA}$		$\phi$		$\pm 80$		deg
Forward voltage	$I_F = 20 \text{ mA}$		$V_F$		2.4	3	V
Reverse voltage	$I_R = 10 \mu\text{A}$		$V_R$	6	15		V
Junction capacitance	$V_R = 0, f = 1 \text{ MHz}$		$C_j$		50		pF

<sup>1)</sup> in one Packing Unit  $I_{V\text{Min.}}/I_{V\text{Max.}} \leq 0.5$

### Pure green

#### TLPP5600

Parameter	Test condition	Part	Symbol	Min	Typ.	Max	Unit
Luminous intensity <sup>1)</sup>	$I_F = 10 \text{ mA}$		$I_V$	0.63	1.6		mcd
Dominant wavelength	$I_F = 10 \text{ mA}$		$\lambda_d$	555		565	nm
Peak wavelength	$I_F = 10 \text{ mA}$		$\lambda_p$		555		nm
Angle of half intensity	$I_F = 10 \text{ mA}$		$\phi$		$\pm 80$		deg
Forward voltage	$I_F = 20 \text{ mA}$		$V_F$		2.4	3	V
Reverse voltage	$I_R = 10 \mu\text{A}$		$V_R$	6	15		V
Junction capacitance	$V_R = 0, f = 1 \text{ MHz}$		$C_j$		50		pF

<sup>1)</sup> in one Packing Unit  $I_{V\text{Min.}}/I_{V\text{Max.}} \leq 0.5$

### Typical Characteristics ( $T_{\text{amb}} = 25 \text{ }^\circ\text{C}$ unless otherwise specified)

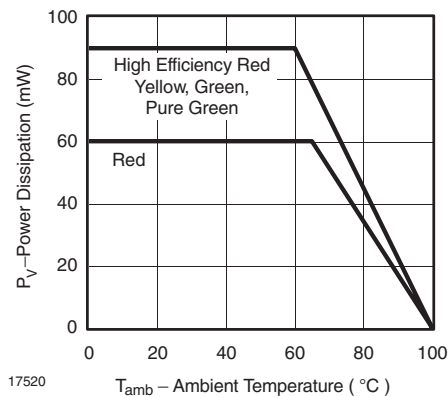

Figure 1. Power Dissipation vs. Ambient Temperature

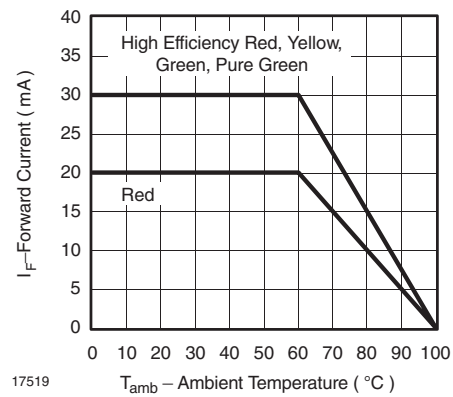
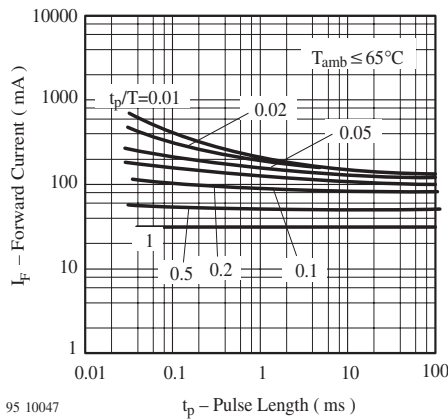
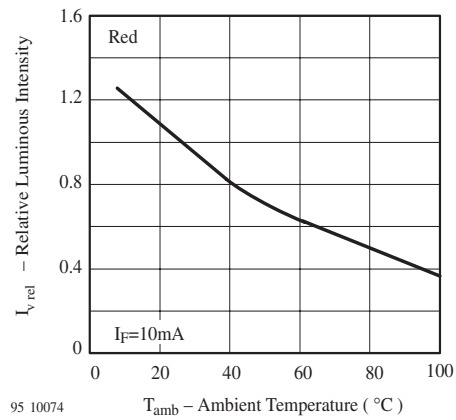

Figure 2. Forward Current vs. Ambient Temperature



95 10047

Figure 3. Forward Current vs. Pulse Length



95 10074

Figure 6. Rel. Luminous Intensity vs. Ambient Temperature

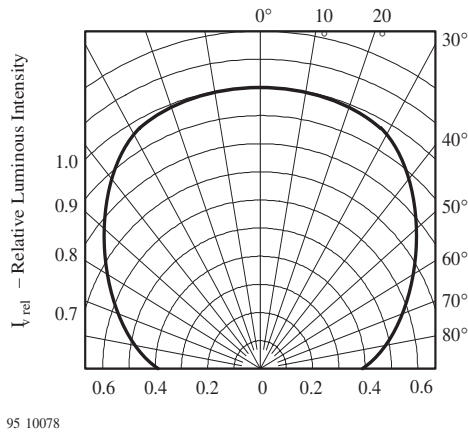

95 10078

Figure 4. Rel. Luminous Intensity vs. Angular Displacement

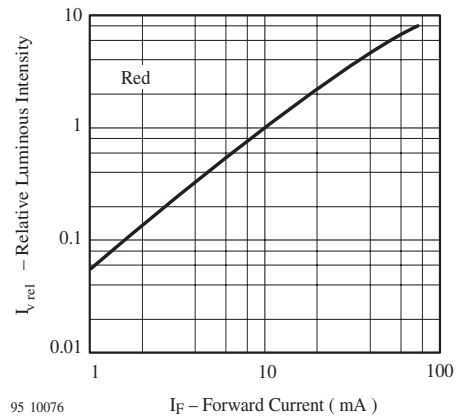

95 10076

Figure 7. Relative Luminous Intensity vs. Forward Current

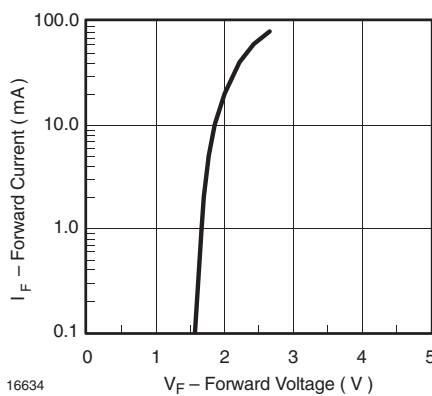

16634

Figure 5. Forward Current vs. Forward Voltage

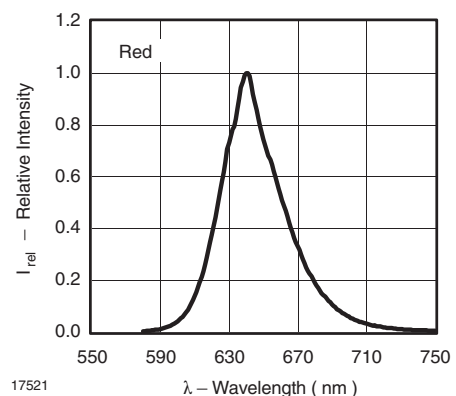

17521

Figure 8. Relative Intensity vs. Wavelength

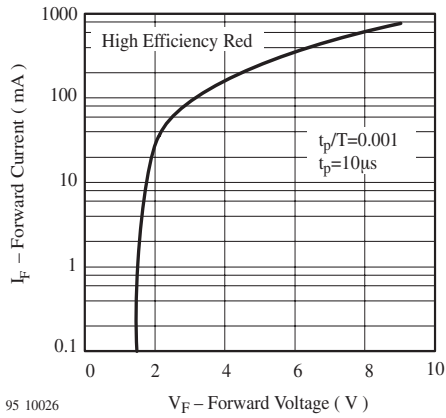

Figure 9. Forward Current vs. Forward Voltage

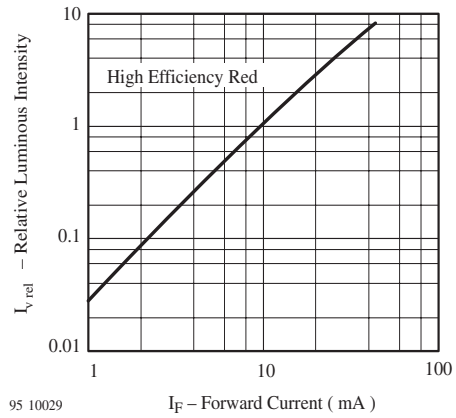

Figure 12. Relative Luminous Intensity vs. Forward Current

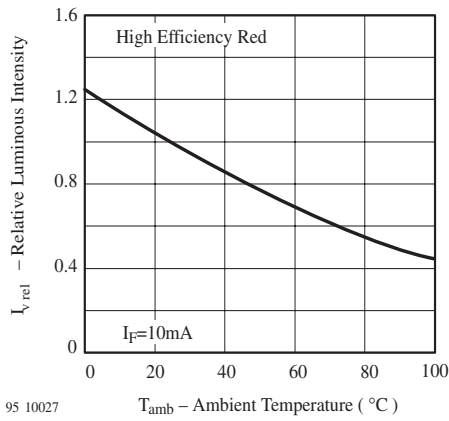

Figure 10. Rel. Luminous Intensity vs. Ambient Temperature

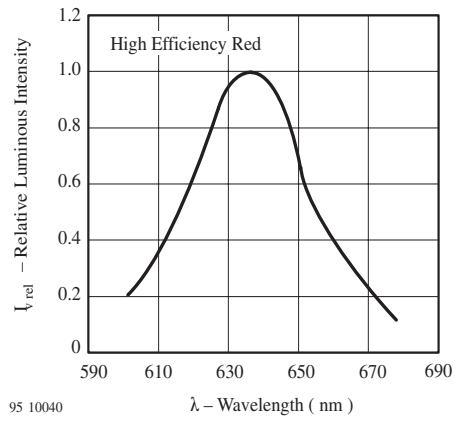

Figure 13. Relative Intensity vs. Wavelength

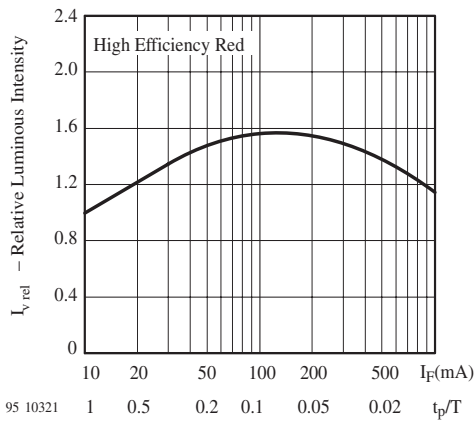

Figure 11. Rel. Lumin. Intensity vs. Forw. Current/Duty Cycle

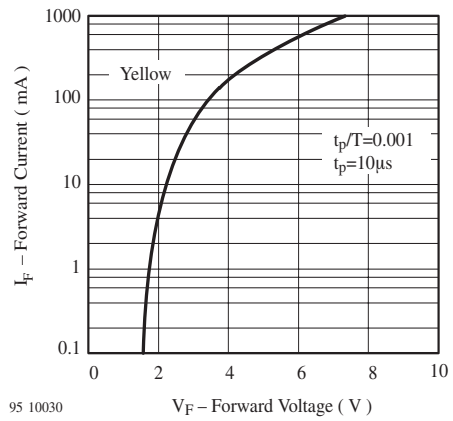

Figure 14. Forward Current vs. Forward Voltage

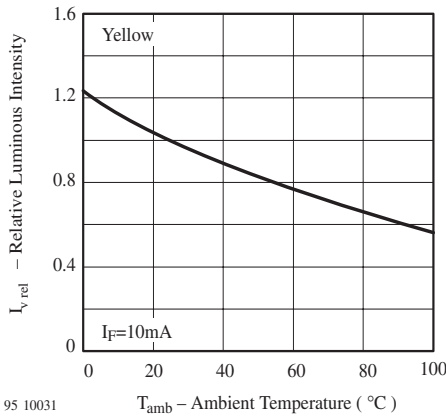

Figure 15. Rel. Luminous Intensity vs. Ambient Temperature

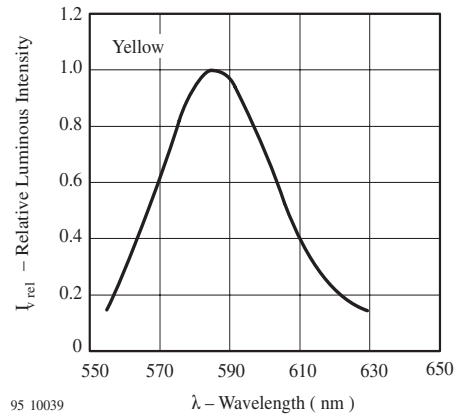

Figure 18. Relative Intensity vs. Wavelength

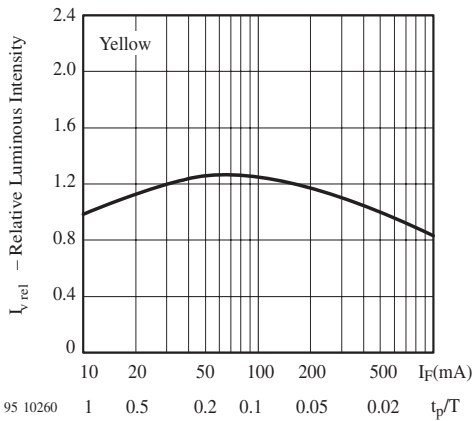

Figure 16. Rel. Lumin. Intensity vs. Forw. Current/Duty Cycle

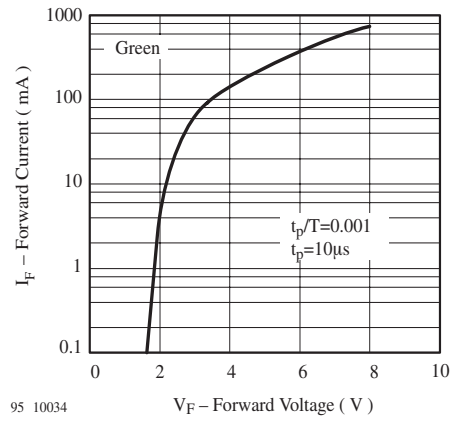

Figure 19. Forward Current vs. Forward Voltage

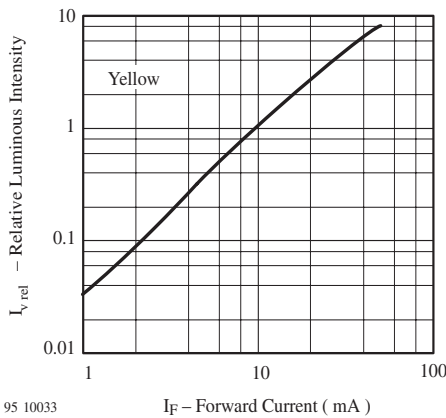

Figure 17. Relative Luminous Intensity vs. Forward Current

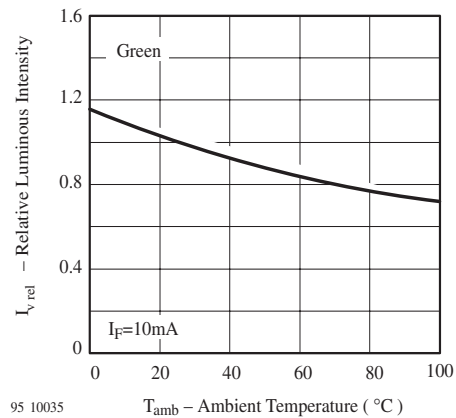

Figure 20. Rel. Luminous Intensity vs. Ambient Temperature

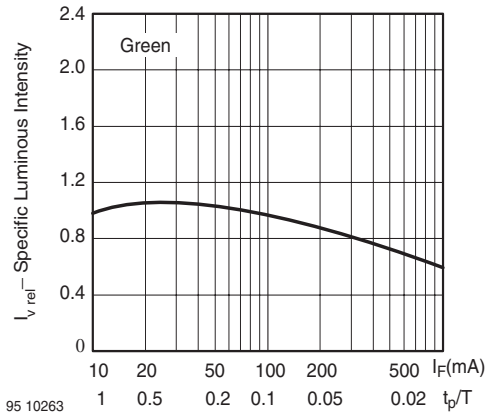

Figure 21. Specific Luminous Intensity vs. Forward Current

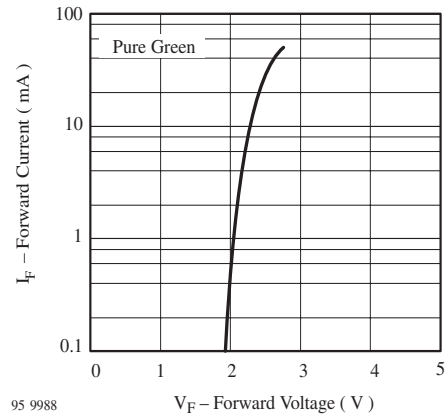

Figure 24. Forward Current vs. Forward Voltage

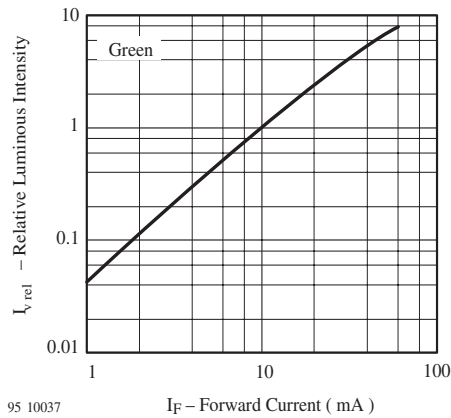

Figure 22. Relative Luminous Intensity vs. Forward Current

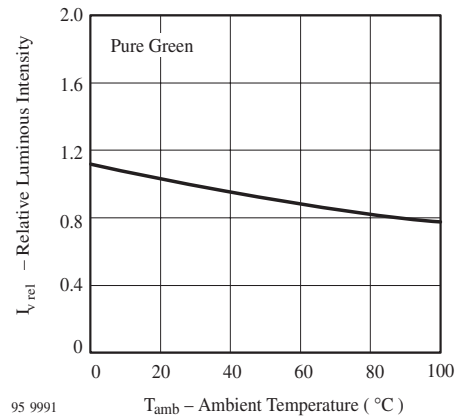

Figure 25. Rel. Luminous Intensity vs. Ambient Temperature

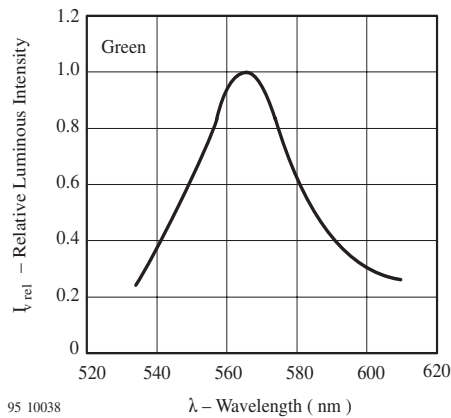

Figure 23. Relative Intensity vs. Wavelength

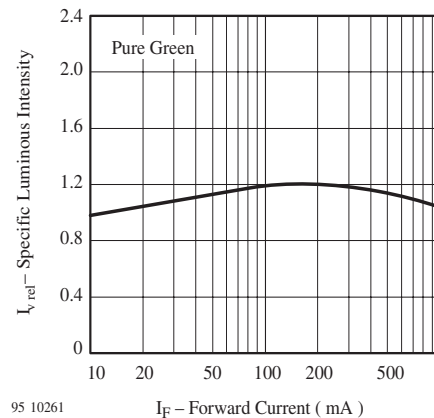
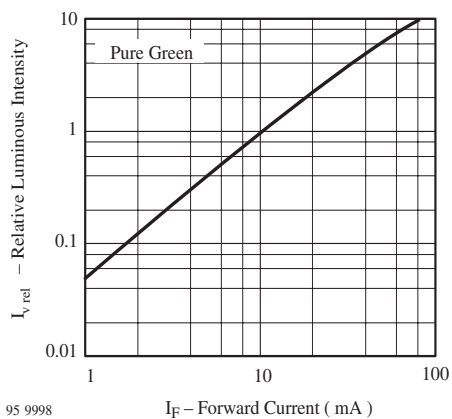
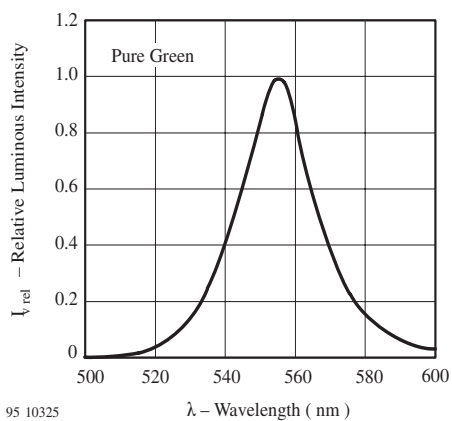

Figure 26. Specific Luminous Intensity vs. Forward Current



95 9998

Figure 27. Relative Luminous Intensity vs. Forward Current



95 10325

Figure 28. Relative Intensity vs. Wavelength



## Package Dimensions in mm

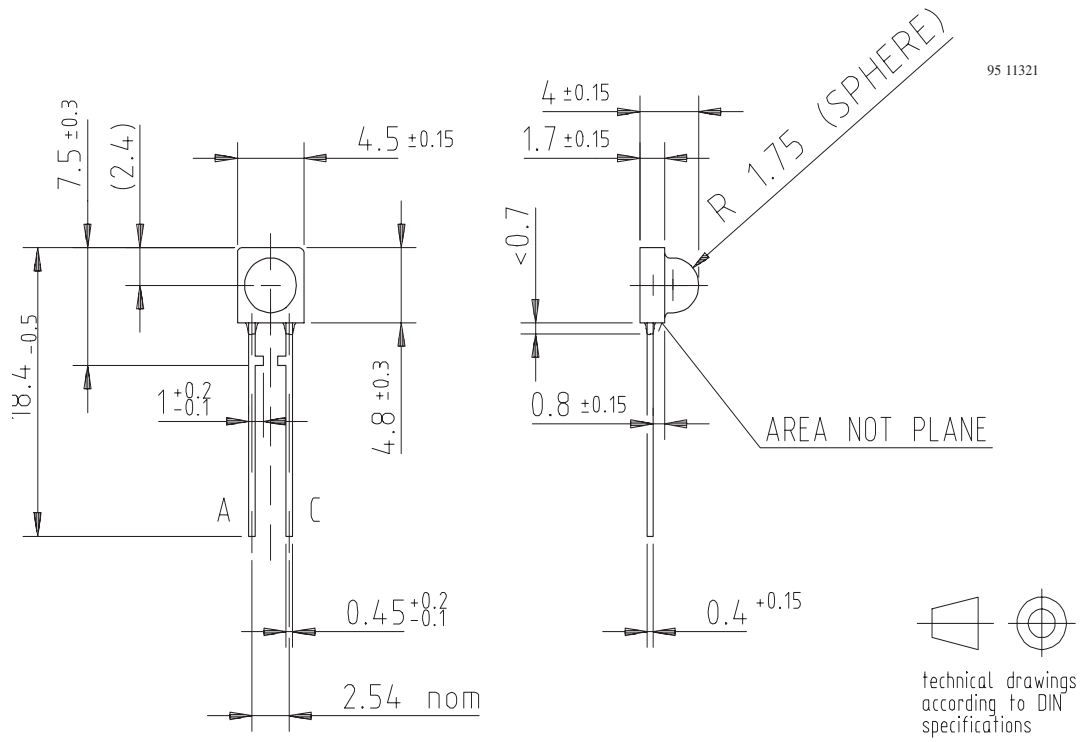

### Ozone Depleting Substances Policy Statement

It is the policy of **Vishay Semiconductor GmbH** to

1. Meet all present and future national and international statutory requirements.
2. Regularly and continuously improve the performance of our products, processes, distribution and operating systems with respect to their impact on the health and safety of our employees and the public, as well as their impact on the environment.

It is particular concern to control or eliminate releases of those substances into the atmosphere which are known as ozone depleting substances (ODSs).

The Montreal Protocol (1987) and its London Amendments (1990) intend to severely restrict the use of ODSs and forbid their use within the next ten years. Various national and international initiatives are pressing for an earlier ban on these substances.

**Vishay Semiconductor GmbH** has been able to use its policy of continuous improvements to eliminate the use of ODSs listed in the following documents.

1. Annex A, B and list of transitional substances of the Montreal Protocol and the London Amendments respectively
2. Class I and II ozone depleting substances in the Clean Air Act Amendments of 1990 by the Environmental Protection Agency (EPA) in the USA
3. Council Decision 88/540/EEC and 91/690/EEC Annex A, B and C (transitional substances) respectively.

**Vishay Semiconductor GmbH** can certify that our semiconductors are not manufactured with ozone depleting substances and do not contain such substances.

**We reserve the right to make changes to improve technical design  
and may do so without further notice.**

Parameters can vary in different applications. All operating parameters must be validated for each customer application by the customer. Should the buyer use Vishay Semiconductors products for any unintended or unauthorized application, the buyer shall indemnify Vishay Semiconductors against all claims, costs, damages, and expenses, arising out of, directly or indirectly, any claim of personal damage, injury or death associated with such unintended or unauthorized use.

Vishay Semiconductor GmbH, P.O.B. 3535, D-74025 Heilbronn, Germany  
Telephone: 49 (0)7131 67 2831, Fax number: 49 (0)7131 67 2423