

1 . Features

- 16 Pin SMD Package
- Low Ripple And Noise
- Input / Output Isolation 1K Vdc Or 2K Vdc
- 100 % Burn-In
- Input Filter With Internal Capacitor
- Custom Design Available
- Net Weight : 4.6 g Typical
- RoHS Converter Certified By SGS

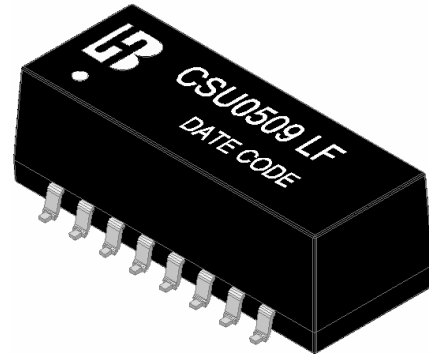

2 . Single Output Selection Guide

(Specifications typical at Ta= +25 , Nominal input voltage, Rated output current unless otherwise noted)

Model No.	Input Voltage (Vdc)	Output Voltage (Vdc)	Output Current (mA) Max	Input Current @No Load (mA) Typ.	Input Current @Max. Load (mA) Typ.	Output Ripple (mV) Max.	Load Regulation (%)Max.	Efficiency (%)Typ.
1) 1K Vdc Isolation								
CSU0509 LF	5	9	200	30	456	70	± 8	79
CSU0509EH LF		9	200	38	486	70	± 8	74
CSU1209 LF	12	9	200	18	188	70	± 8	80
CSU1209EH LF		9	200	21	197	70	± 8	76
2) 2K Vdc Isolation								
CSU0509-20 LF	5	9	200	30	456	70	± 8	79
CSU0509EH-20 LF		9	200	38	486	70	± 8	74
CSU1209-20	12	9	200	18	188	70	± 8	80
CSU1209EH-20 LF		9	200	21	197	70	± 8	76

Notes :

1. CSUxxyyEH LF is for customer design.
2. Enable signal : Logic Hi – Active.
3. Load regulation is for output current change from 20% to 100% Max. load.



Bothhand Enterprise Inc.

www.bothhand.com.tw E-mail: sales@bothhand.com.tw

3 . Absolute Maximum Ratings

(Exceeding these values may damage the module. These are not continuous operating ratings)

Parameter	Condition	Min.	Typ.	Max.	Unit
Input Absolute Voltage Range	5V Input Model	-0.7	5	7.5	Vdc
	12V Input Model	-0.7	12	15	
Max. Output Power		---	---	2.0	W
Output Short Circuit Duration	Nominal Input Range	---	---	1.0	Second
Operation Temperature (Ambient Temperature)	Output Full Load	-40	---	+85	
Storage Temperature		-55	---	+125	

4 . Nominal Input/Output Electrical Specifications

(Specifications typical at Ta= +25 ,Nominal input voltage ,Rated output current unless otherwise noted)

Parameter	Condition	Min.	Typ.	Max.	Unit
Input Voltage Range	5V Input Model	4.5	5	5.5	Vdc
	12V Input Model	10.8	12	13.2	
Output Voltage Accuracy	Nominal Input	---	---	± 5.0	%
Switching Frequency		---	70	---	KHz
Temperature Coefficient		---	± 0.01	± 0.02	% /
Isolation Voltage	Standard Series	1000	---	---	Vdc
	High Isolation Series	2000	---	---	Vdc
Isolation Resistance	500Vdc	1000	---	---	M
Isolation Capacitance	1KHz / 250mV rms	---	50	---	pF
Max. Line Regulation (per 1.0% change in input change)		---	---	1.3	%

5 . General Specification

Parameter	Specification	Condition
Isolation Voltage	1000 /2000Vdc	Test Duration 60 Seconds / 0.5 mA
Isolation Resistance	1000 M Min.	@ 500 Vdc
Operating Temperature (1)	-40 ~ +85	@ Ambient Temperature With Natural Convention
Operating Temperature (2)	-40 ~ +95	@ Case Surface Temperature
Storage Temperature	-55 ~ +125	---
Humidity	Up To 90 %	---
Cooling	Free Air Convection	---
Case Type	Plastic	---



6 . Ordering Information

7 . Power Derating Curve

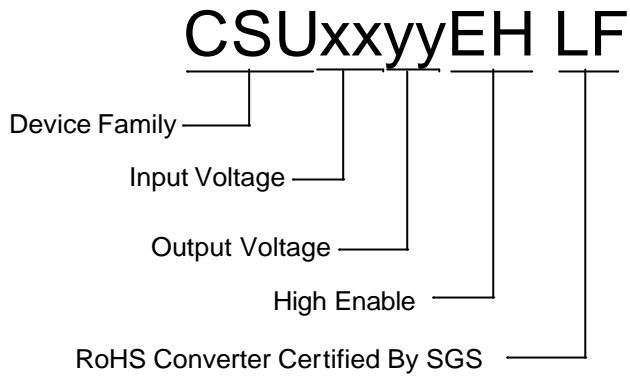

Temperature derating graph

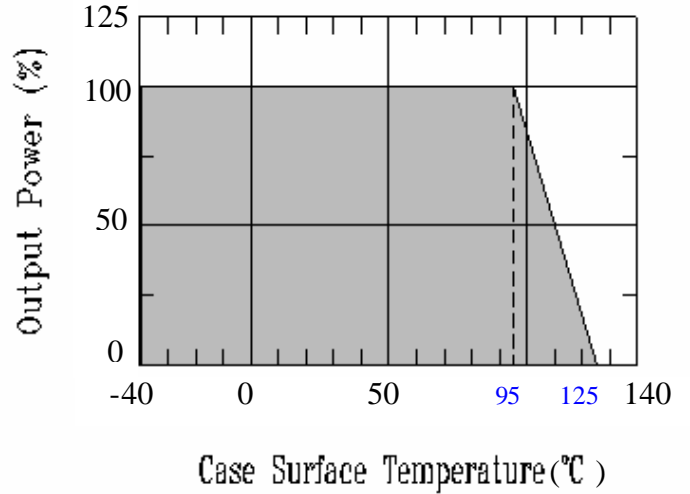

8 . Efficiency & Output Load Chart

Vout= 9 Vdc

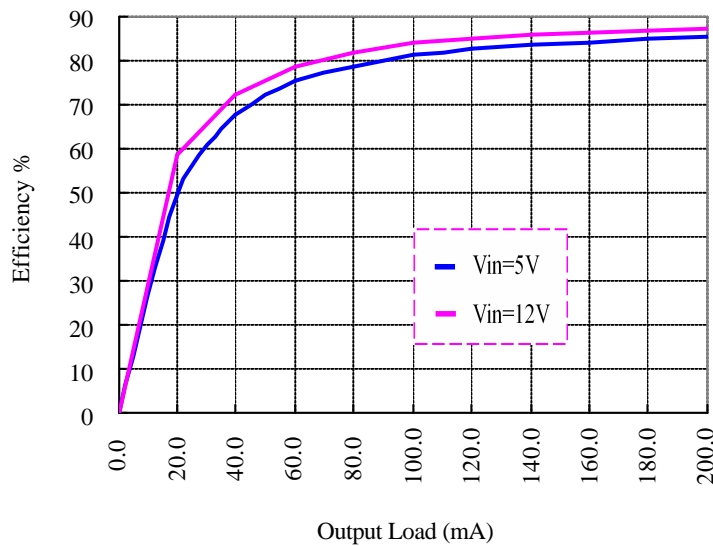

9 . Mechanical Dimension

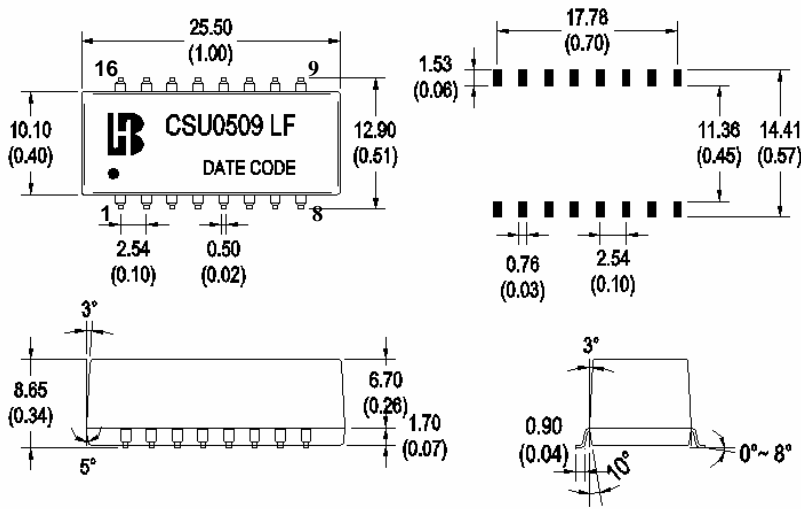

Pin	1K & 2K Vdc - Single	Pin
1	-Vin	16
2	Ve*	15
3	+Vin	14
4	NC	13
5		12
6	+Vo	11
7		10
8	-Vo	9

Note : " * " If no Enable function, the pin is NC.

Units : mm (inch)

Tolerance : 0.xx ± 0.25 (0.xx ± 0.01)

10 . Recommended Footprint Details

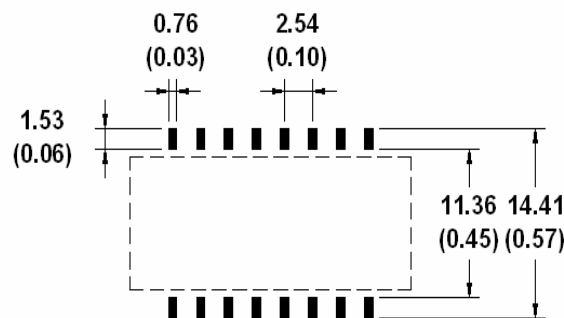

Units : mm (inch)

Tolerance : 0.xx ± 0.25 (0.xx ± 0.01)



Bothhand Enterprise Inc.

www.bothhand.com.tw E-mail: sales@bothhand.com.tw

11 . Package

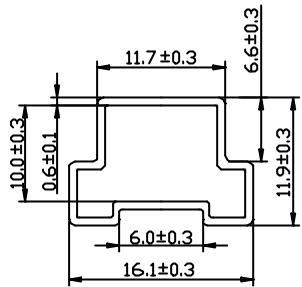

TUBE MECHANICAL DIMENSION

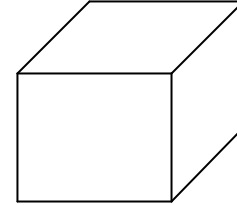
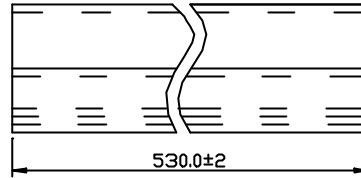

INNER CARTON:565*115*117

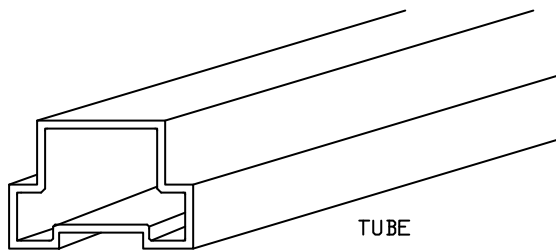

TUBE

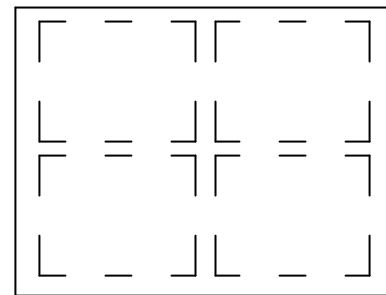

EXPORT CARTON:580*255*265

1. TUBE=20PCS
2. INNER CARTON=50 TUBE=50*20=1000PCS
3. EXPORT CARTON=4 INNER CARTON=4*1000=4000PCS

