

Octal EMI/RFI Tapped Filter

Features

- 8 EMI/RFI protection lines/package
- Stable resistor-capacitor network
- No signal delays
- Saves board space and component cost
- Suitable for PCMCIA interface cards
- Available in SOIC (PRC201), QSOP (PRC211) and TSSOP (PRC221) packages

Applications

- EMI/RFI Filter
- Low Pass Filter

Product Description

The PRC201/211/221 Tapped Filter device is designed to suppress EMI/RFI noise on high speed data lines and at I/O ports of PCMCIA fax/modem and LAN type cards. This integrated thin film resistor-capacitor network is housed in a ultra low profile, surface mount package suitable for bottom side mounting to the card which minimizes space and routing problems and improves reliability.

EMI/RFI filters are needed to suppress unwanted noise over a wide frequency spectrum. Traditionally, ferrite beads have been used for EMI/RFI filtering but are bulky and ineffective at low frequencies and have saturation problems at high frequencies. Resistor-capacitor networks generally offer the best technical solution for effective EMI/RFI filtering but conventional thick film-based EMI/RFI filters solutions do not effectively suppress noise at high frequencies due inherently high parasitic inductance which becomes the dominant component of the capacitor's impedance past resonance. This significantly affects the high frequency performance of the filter.

The PRC201/211/221 Tapped Filter, an integrated filtering solution, is fabricated on a silicon substrate using advanced thin film technology. It features very low parasitic inductance and suppresses EMI/RFI noise at frequencies ranging from low through those exceeding 1000 MHz, resulting in superior filter design and effectiveness.

Typical Application Circuit

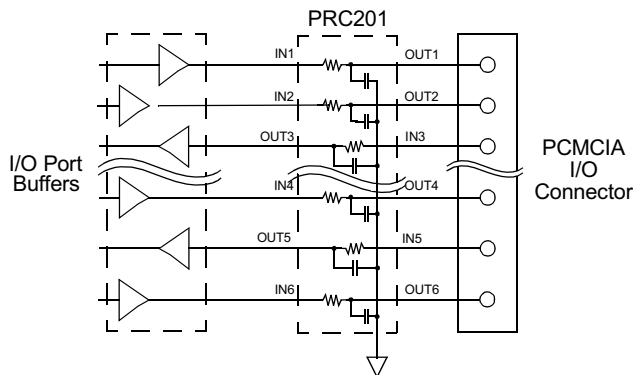

Electrical Schematic

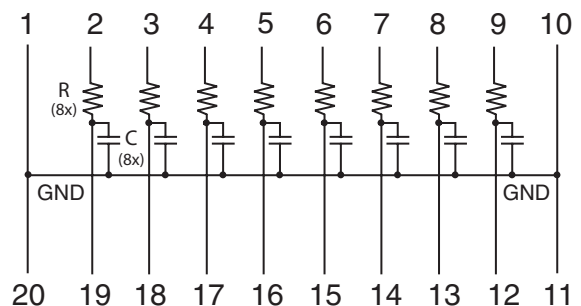



PACKAGE / PINOUT DIAGRAMS

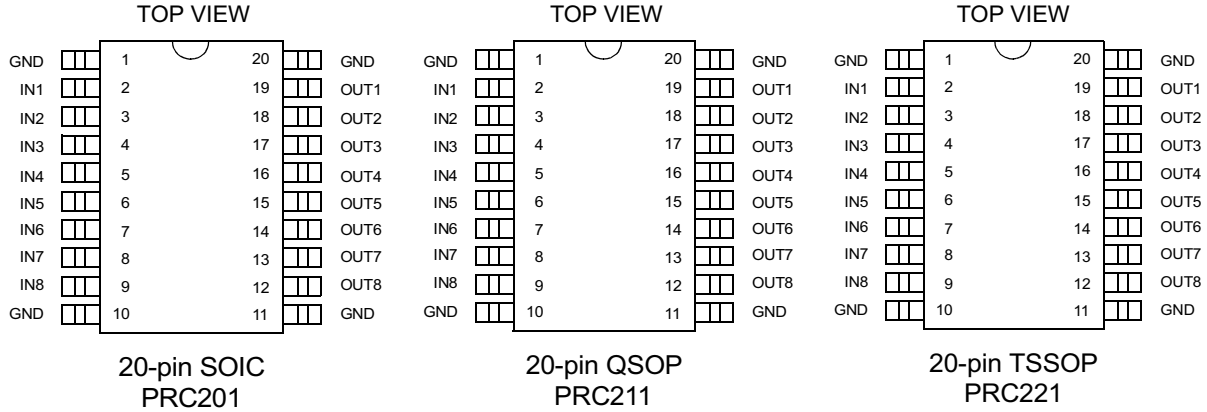

Note: SOIC, QSOP and TSOP package sizes may differ. This drawing is not to scale.

PIN DESCRIPTIONS

PIN	NAME	DESCRIPTION
1	GND	Common Ground
2	IN1	Filter 1 Input
3	IN2	Filter 2 Input
4	IN3	Filter 3 Input
5	IN4	Filter 4 Input
6	IN5	Filter 5 Input
7	IN6	Filter 6 Input
8	IN7	Filter 7 Input
9	IN8	Filter 8 Input
10	GND	Common Ground
11	GND	Common Ground
12	OUT8	Filter 8 Output
13	OUT7	Filter 7 Output
14	OUT6	Filter 6 Output
15	OUT5	Filter 5 Output
16	OUT4	Filter 4 Output
17	OUT3	Filter 3 Output
18	OUT2	Filter 2 Output
19	OUT1	Filter 1 Output
20	GND	Common Ground



Ordering Information

The PRC201/211/221 is available in both standard and non-standard (custom) part configurations. The follow-

ing Part Numbering Key is applicable for all variants of these devices, standard and non-standard.

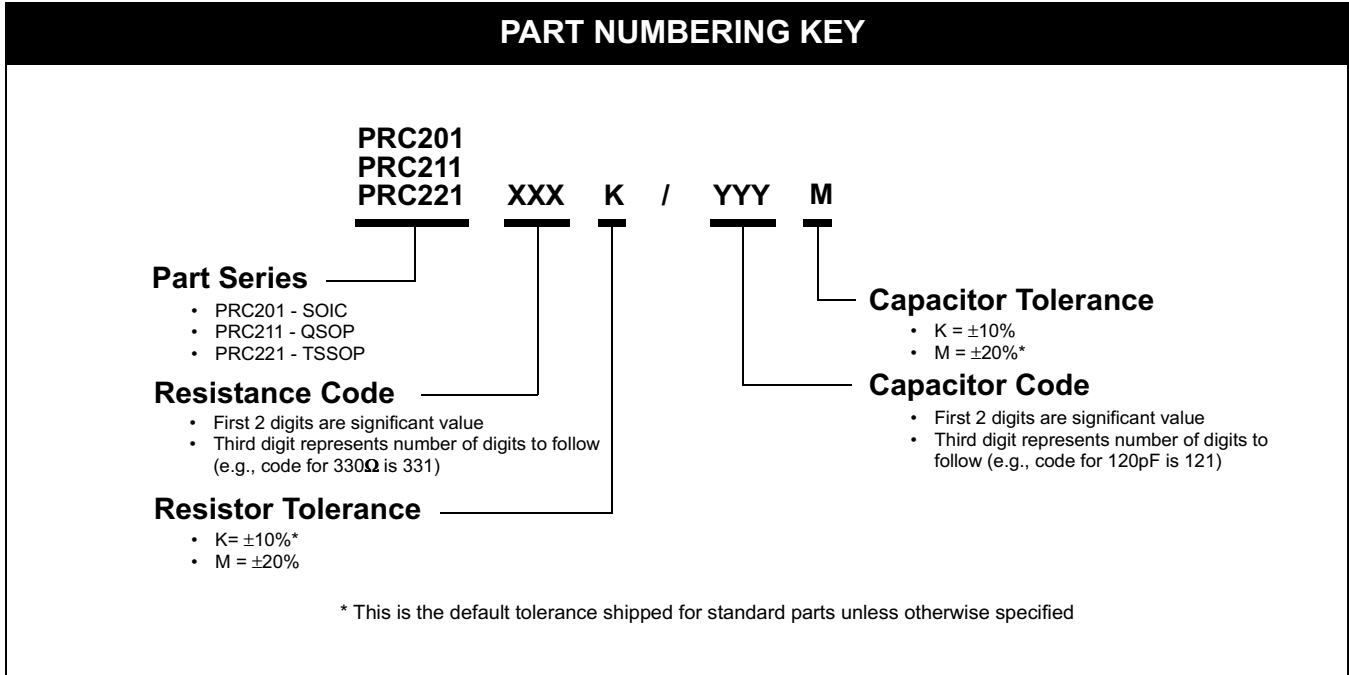

Standard Part Information

The PRC201/211/221 is available in a number of standard RC combinations. Other RC combinations are available as custom devices. Please see the section

“Non-standard Part Information” on page 5 for more information. .

STANDARD PART VALUES				
RC Code	R (Ω)	C (pF)	$f_c @ 3dB$	Breakdown Voltage (Max)
100/150F	10	15	1062MHz	296V
330/101F	33	100	48MHz	81V
330/251F	33	250	19MHz	37V
330/470F	33	47	103MHz	94V
390/221F	39	220	19MHz	43V
470/470F	47	47	72MHz	94V
750/500F	75	50	42MHz	187V
101/101F	100	100	16MHz	81V
101/151F	100	150	11MHz	45V

Ordering Information (cont'd)

STANDARD PART NUMBERING INFORMATION						
RC Code	Pins	Package	Tolerance		Ordering Part Number ¹	Part Marking
			R	C		
100/150F	20	SOIC	±10%	±20%	PRC201100K/150M	PRC201100K/150M
330/101F	20	SOIC	±10%	±20%	PRC201330K/101M	PRC201330K/101M
330/251F	20	SOIC	±10%	±20%	PRC201330K/251M	PRC201330K/251M
330/470F	20	SOIC	±10%	±20%	PRC201330K470M	PRC201330K470M
390/221F	20	SOIC	±10%	±20%	PRC201390K221M	PRC201390K221M
470/470F	20	SOIC	±10%	±20%	PRC201470K470M	PRC201470K470M
750/500F	20	SOIC	±10%	±20%	PRC201750K500M	PRC201750K500M
101/101F	20	SOIC	±10%	±20%	PRC201101K101M	PRC201101K101M
101/151F	20	SOIC	±10%	±20%	PRC201101K151M	PRC201101K151M
100/150F	20	QSOP	±10%	±20%	PRC211100K/150M	PRC211100K/150M
330/101F	20	QSOP	±10%	±20%	PRC211330K/101M	PRC211330K/101M
330/251F	20	QSOP	±10%	±20%	PRC211330K/251M	PRC211330K/251M
330/470F	20	QSOP	±10%	±20%	PRC211330K470M	PRC211330K470M
390/221F	20	QSOP	±10%	±20%	PRC211390K221M	PRC211390K221M
470/470F	20	QSOP	±10%	±20%	PRC211470K470M	PRC211470K470M
750/500F	20	QSOP	±10%	±20%	PRC211750K500M	PRC211750K500M
101/101F	20	QSOP	±10%	±20%	PRC211101K101M	PRC211101K101M
101/151F	20	QSOP	±10%	±20%	PRC211101K151M	PRC211101K151M
100/150F	20	TSSOP	±10%	±20%	PRC221100K/150M	PRC221100K/150M
330/101F	20	TSSOP	±10%	±20%	PRC221330K/101M	PRC221330K/101M
330/251F	20	TSSOP	±10%	±20%	PRC221330K/251M	PRC221330K/251M
330/470F	20	TSSOP	±10%	±20%	PRC221330K470M	PRC221330K470M
390/221F	20	TSSOP	±10%	±20%	PRC221390K221M	PRC221390K221M
470/470F	20	TSSOP	±10%	±20%	PRC221470K470M	PRC221470K470M
750/500F	20	TSSOP	±10%	±20%	PRC221750K500M	PRC221750K500M
101/101F	20	TSSOP	±10%	±20%	PRC221101K101M	PRC221101K101M
101/151F	20	TSSOP	±10%	±20%	PRC221101K151M	PRC221101K151M

Note 1: Parts are shipped in Tape & Reel form unless otherwise specified.

Ordering Information (cont'd)

Non-standard Part Information

California Micro Devices can optionally develop a semi-custom solution based on the values in the table below. A Non-Recurring Engineering (NRE) charge may apply for all fully customized requirements and a minimum order/lot size may be required. Please direct

your detailed circuit configuration and specification requirements to your local CAMD representative or to the factory for a quotation.

NON-STANDARD PART VALUES

Parameter	Range
Resistance Range	10 to 150 Ω
Capacitance Range	15 to 250 pF

Specifications

ABSOLUTE MAXIMUM RATINGS

PARAMETER	RATING	UNITS
Breakdown Voltage (See Note 1)	See Standard Part Values Table	VDC
Storage Temperature Range	-65 to +150	$^{\circ}\text{C}$
Power Rating per Resistor (See Note 2)	100	mW
Power Dissipation (See Note 3)	1.0	W

Note 1: These values apply for Standard Parts only. The Breakdown Voltage for Non-Standard parts will be specified on a per-case basis.

Note 2: With 0 Ohm source impedance.

Note 3: In application, the sum of power dissipation across all resistors cannot exceed 1W total for the package.

STANDARD OPERATING CONDITIONS

PARAMETER	RATING	UNITS
Operating Temperature Range	-55 to +125	$^{\circ}\text{C}$

ELECTRICAL OPERATING CHARACTERISTICS

SYMBOL	PARAMETER	CONDITIONS	MIN	TYP	MAX	UNITS
TOL _R	Resistor Absolute Tolerance	Note 1				
	Standard Tolerance				± 10	%
	Non-Standard Tolerance				± 10	%
TOL _C	Capacitor Absolute Tolerance	Note 1				
	Standard Tolerance				± 20	%
	Non-Standard Tolerance				± 10	%

Note 1: The reference to "Standard" and "Non-Standard" tolerance here has no relation to "Standard Part" and "Non-Standard Part". All devices are available in both 10% and 20% tolerances. Please see the Part Number Key for ordering information.

Mechanical Details

PRC201/211/221 devices are packaged in 20-pin SOIC, QSOP and TSSOP packages. Dimensions for these packages are presented on the following pages.

SOIC Mechanical Specifications

For complete information on the SOIC-20 package, see the specific California Micro Devices Package Information document.

PACKAGE DIMENSIONS				
Package	SOIC Wide			
Pins	20			
Dimensions	Millimeters		Inches	
	Min	Max	Min	Max
A	2.35	2.85	0.093	0.104
A1	0.10	0.30	0.004	0.012
B	0.33	0.51	0.013	0.020
C	0.23	0.32	0.009	0.013
D	12.60	13.21	0.496	0.520
E	7.40	7.87	0.291	0.310
e	1.27 BSC		0.050 BSC	
H	10.00	10.65	0.394	0.419
L	0.40	1.27	0.015	0.050
# per tube	38 pieces*			
# per tape and reel	1000 pieces			
Controlling dimension: inches				

* This is an approximate amount which may vary.

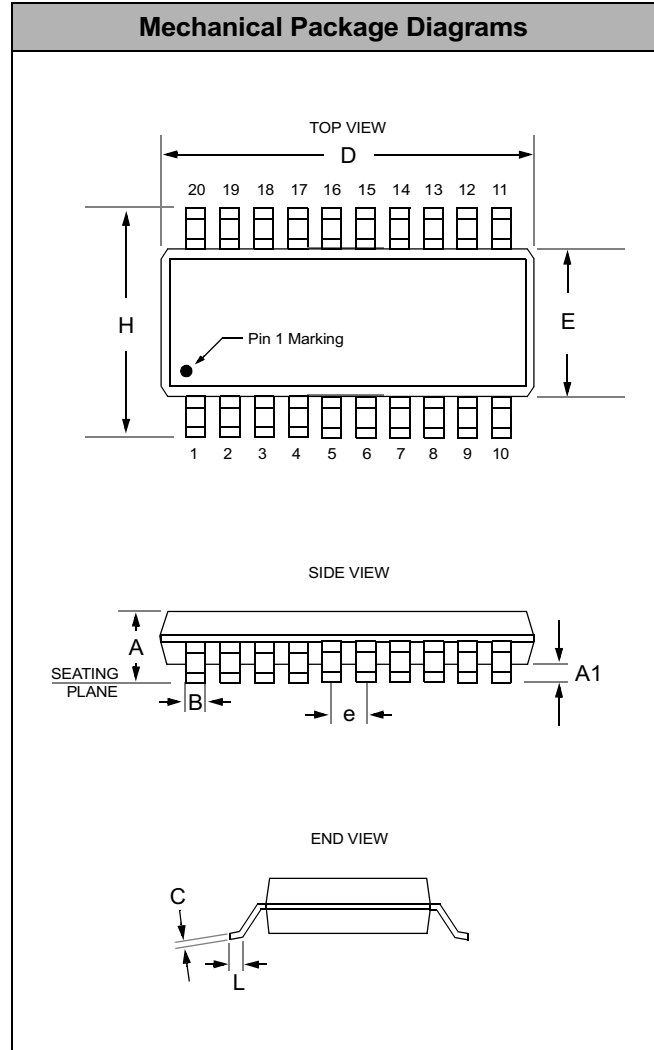

Package Dimensions for SOIC-20



Mechanical Details (cont'd)

QSOP Mechanical Specifications

For complete information on the QSOP-20 package, see the specific California Micro Devices Package Information document.

PACKAGE DIMENSIONS				
Package	QSOP (JEDEC name is SSOP)			
Pins	20			
Dimensions	Millimeters		Inches	
	Min	Max	Min	Max
A	1.35	1.75	0.053	0.069
A1	0.10	0.25	0.004	0.010
B	0.20	0.30	0.008	0.012
C	0.18	0.25	0.007	0.010
D	8.56	8.73	0.337	0.344
E	3.81	3.98	0.150	0.157
e	0.64 BSC		0.025 BSC	
H	5.79	6.19	0.228	0.244
L	0.40	1.27	0.016	0.050
# per tube	57 pieces*			
# per tape and reel	2500 pieces			
Controlling dimension: inches				

* This is an approximate amount which may vary.

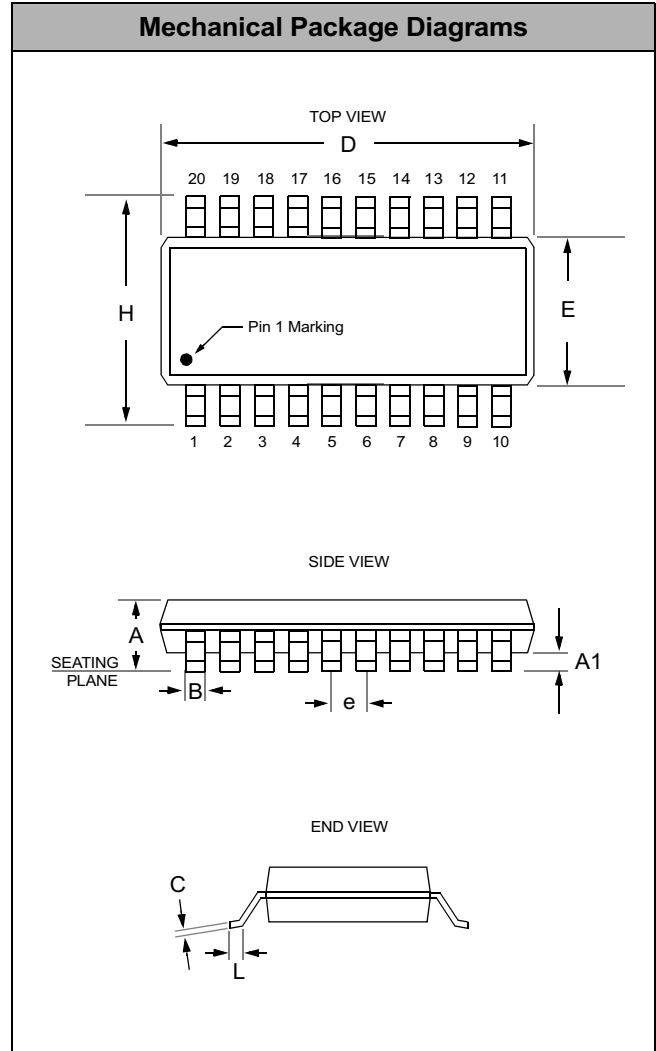

Package Dimensions for QSOP-20



Mechanical Details (cont'd)

TSSOP Mechanical Specifications

For complete information on the TSSOP-20 package, see the specific California Micro Devices Package Information document.

PACKAGE DIMENSIONS				
Package	TSSOP			
Pins	20			
Dimensions	Millimeters		Inches	
	Min	Max	Min	Max
A	—	1.10	—	0.0433
A1	0.05	0.15	0.002	0.006
B	0.19	0.30	0.0075	0.0118
C	0.09	0.20	0.0035	0.0079
D	6.40	6.60	0.252	0.260
E	4.30	4.50	0.169	0.177
e	0.65 BSC		0.0256 BSC	
H	6.25	6.50	0.246	0.256
L	0.50	0.70	0.020	0.028
# per tube	74 pieces*			
# per tape and reel	2500 pieces			
Controlling dimension: millimeters				

* This is an approximate amount which may vary.

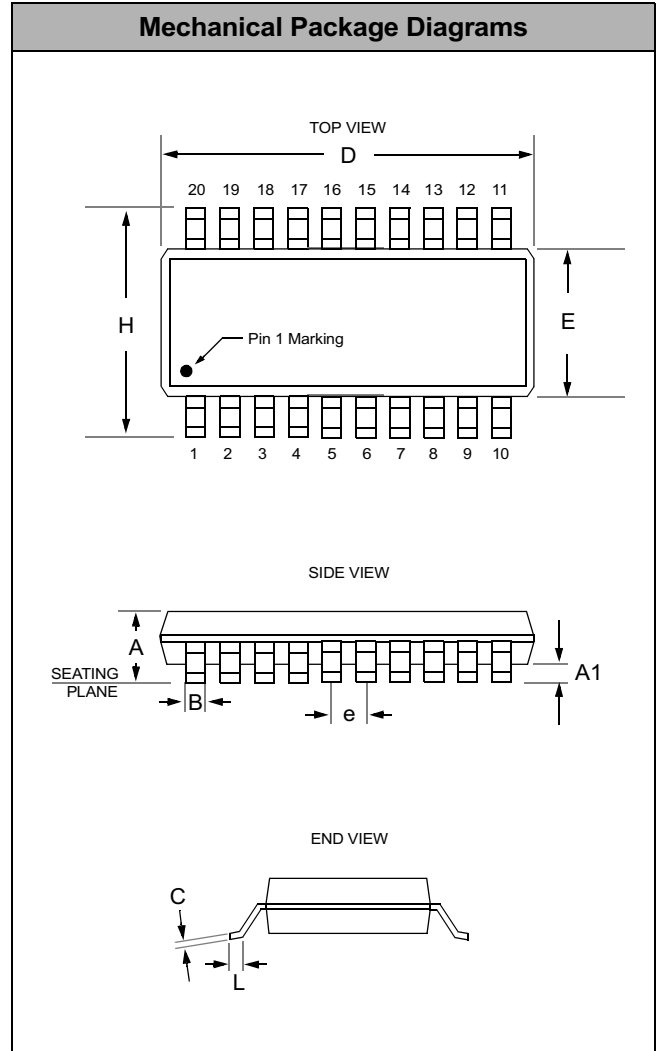

Package Dimensions for TSSOP-20