



# AN1255 APPLICATION NOTE

## NEW CIRCUITAL SOLUTION TO EFFICIENTLY DRIVE AN AC MONOPHASE MOTOR OR AC LOAD BY ST52X420

Author: M. Di Guardo, M. Lo Presti, V. Marino

### INTRODUCTION

This Application Note shows a new solution to efficiently drive a monophase motor or any AC load. This new modulation technique, together with Fuzzy Logic algorithms, allows to obtain high efficiency systems at low-cost for home appliances applications. The aim of the solution is to vary the voltage applied to the motor or AC load starting directly from the Mains, without inverter topology. This is obtained by using only an AC/AC constant frequency conversion thus optimizing the filtering part needed to respect the EMC/EMI regulation.

Nowadays, a lot of consumer and industrial products are based on AC monophase or universal motors: washing machines, dishwashers, air conditioning systems, refrigerators, fans and ventilators. Efficiency and system cost are the leading factors in the choice of the motor type together with electronic drivers and control technique.

Though the choice of three-phases induction or brushless motors with inverters, can guarantee an improvement in overall performances, the higher system cost reduces their applicability in Home Appliances systems and, in general, to low/medium-end applications.

Most of today's control techniques for monophase and universal motors are based on phase angle partialization and a simple triac as a driver. The economic advantages offered by this solution are counterbalanced by the high harmonic distortion introduced in motor signals leading to low efficiency.

To achieve better results in terms of efficiency, more complex driver topologies can be chosen. Therefore, this Application Note describes a new cost effective solution for monophase motors that allows to improve results with respect to triac drivers though keeping system cost lower than with inverter topologies. Also, advantages offered by fuzzy control techniques implemented by ST52x420 microcontroller are shown.

### STANDARD TOPOLOGY FOR MOTOR CONTROL

As already introduced above, today among the most commonly used drivers for monophase motors, triac driver and phase angle partialization based techniques are more and more subject to criticism due to the high harmonic distortion and low efficiency provided. The new European regulations require an optimization in the efficiency of systems and heavy filtering stages, especially in the case of medium/high powers, for EMI and EMC constraints towards the mains. Inverter driver systems, based on topologies like the ones shown in Figure 1, allows to obtain appreciable results in this direction.

Figure 1. Inverter based topology for motor control

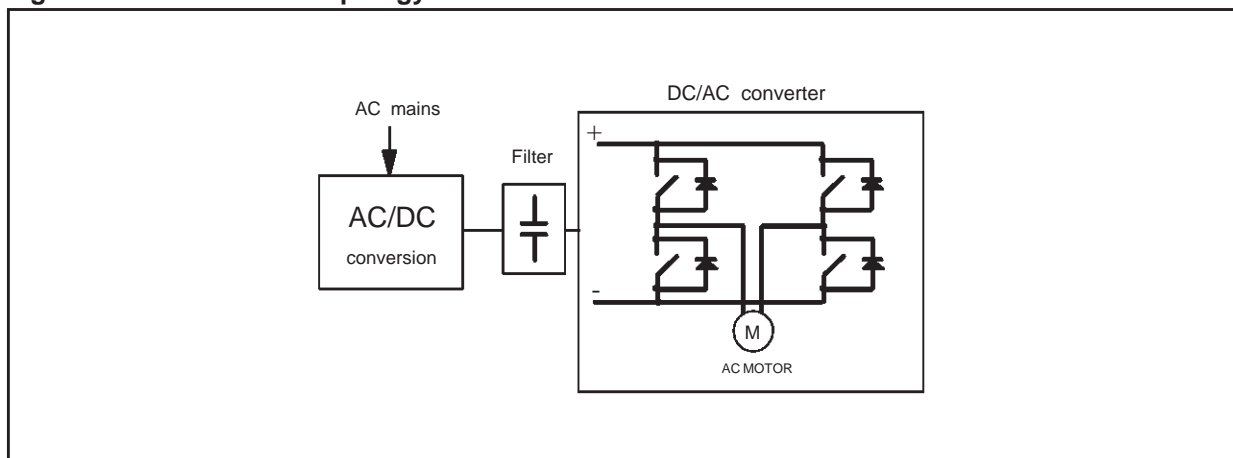
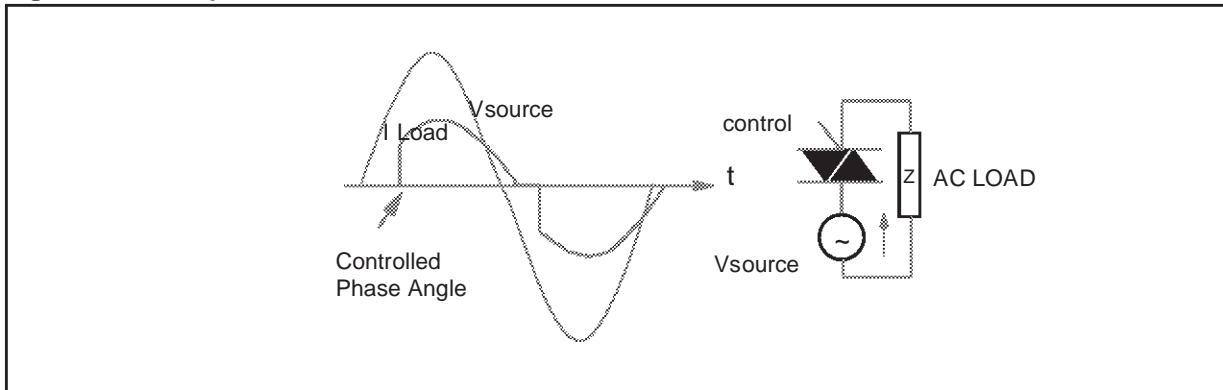

Figure 2. Phase partialisation method



However, inverter systems need a double conversion, (AC/DC and DC/AC) and furthermore require complex techniques of modulation and control implemented on medium/high end microcontrollers. In the overall the gain in performances is balanced by an electronic system cost that is not acceptable in low-end applications.

Another method to change the RMS voltage applied in AC motor is the well known phase partialisation with triac. In this case the voltage is a function of the firing angle of the triac (Figure 2).

The driver topology proposed provides a more cost-effective solution, though keeping the harmonic contents of motor signal at a satisfactory level.

### SINGLE PHASE MOTORS

The solution proposed is well suitable for single phase motors with capacitor for their similarities with normal squirrel-cage three-phase induction motors.

The stator windings of a single-phase motor are two: one connected with the mains and the other, the auxiliary one, is physically in quadrature with the main winding. This, can be generally wound with turns of small wire to produce a winding of very high resistance. The main winding has a relatively low resistance and high inductance, which results in a phase difference between the two windings when the voltage is applied to the terminals. A centrifugal switch or relay opens the auxiliary winding when the rotor reaches a certain speed; then the motor runs on the main winding only.

In practice, where not much starting torque is required, instead of a high resistance winding, the starting winding is designed to operate in conjunction with a capacitor permanently in series with the auxiliary winding during the operation of the motor (Figure 3).

This arrangement gives a 90°-shift of the two magnetic fields generated respectively by L1 and L2 winding currents. This configuration generates a rotating field similar to the three-phase induction motors.

Figure 3. Schematisation of an AC monophas motor

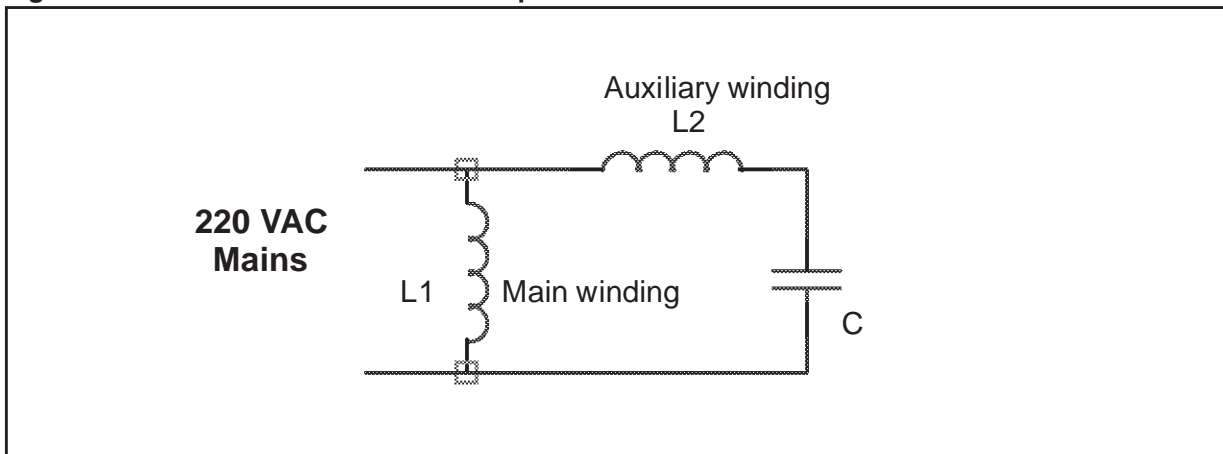

## NEW CIRCUITAL SOLUTION FOR MONOPHASE MOTOR CONTROL

This circuit allows to modify the RMS values of the motor phase voltage, limiting the third harmonic magnitude. In addition, only an AC/AC conversion is performed and an appreciable reduction in the electronic complexity with respect to inverter bridges can be appreciated (Figure 5). The method is based on a bi-directional chopper mains with a fixed frequency and variable duty-cycle. The effect generated will be a sinusoidal current in the load with a level given by the duty-cycle value (Figure 4).

**Figure 4. Motor Current Level**

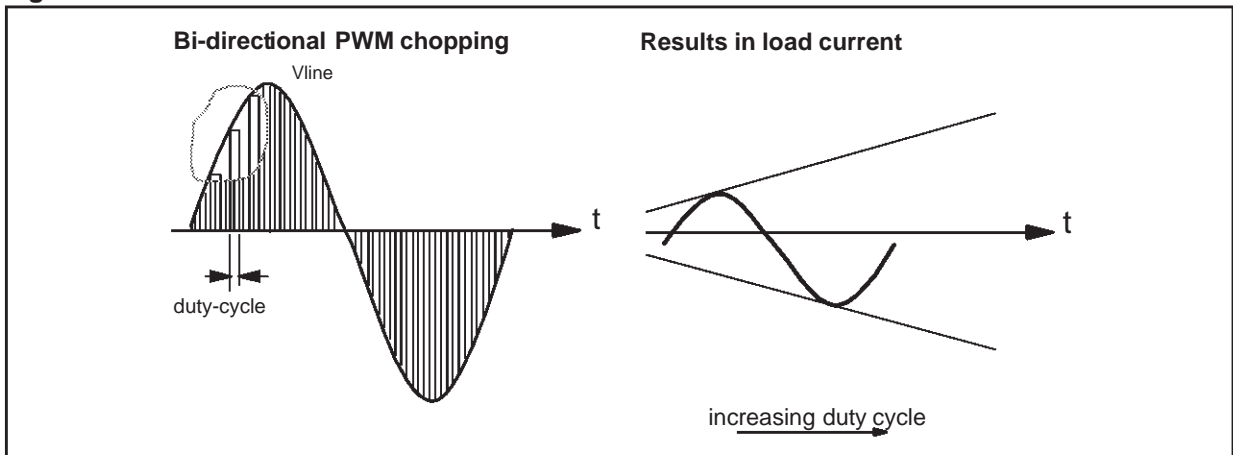

The monophase motor M1 is powered with a chopped sinusoidal voltage. Transistor Q1, (either an IGBT or a Power MOS), that is driven by a PWM signal coming from ST52x420 microcontroller, allows, together with bridge D1-D4, to chopper mains voltage during either positive and negative half periods. The duty cycle of the PWM signal allows to change the motor voltage level and then the motor current.

Current freewheeling for the magnetization of the motor is provided by the diodes D7 and D9 which are selected respectively by bipolar transistors Q2 and Q3, alternatively ON in one of the two motor current half periods. The turning on of these transistors is given automatically by employing D6-D8 and D10-D11 V-forward diode network (Figure 5).

**Figure 5. New circuitual solution for monophase motor (Only for high  $\cos\phi$  load)**

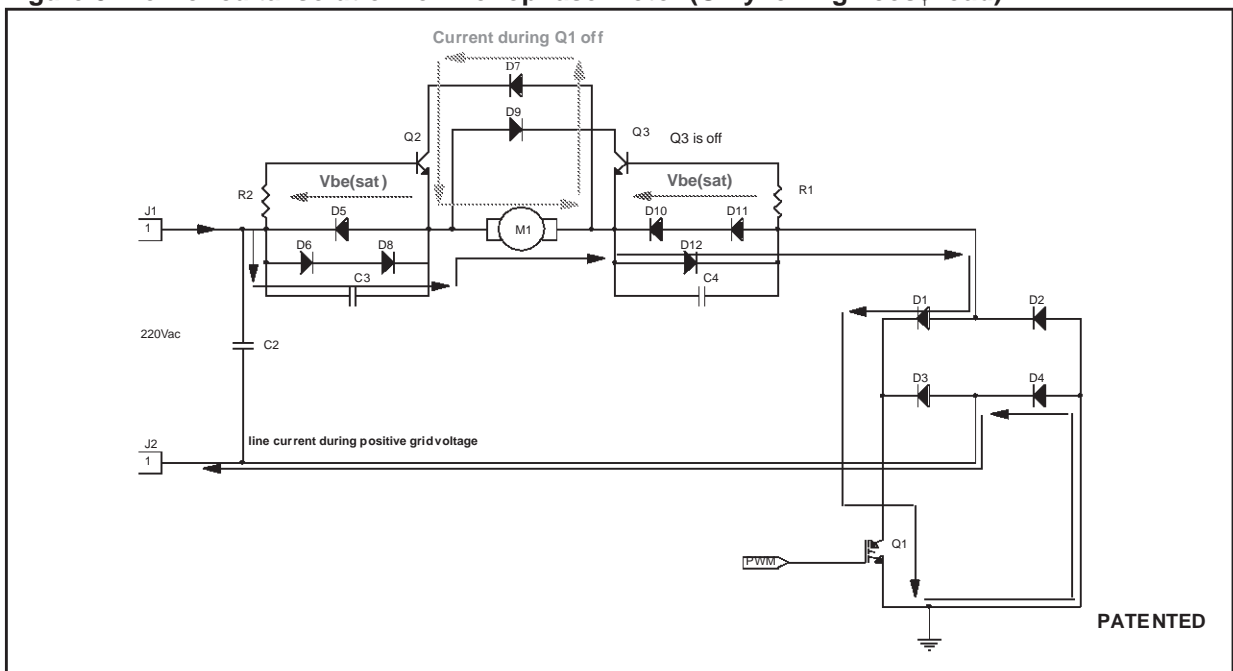

## AN1255 - APPLICATION NOTE

Thanks to this Vforwards diode, the base current  $I_{BQ2}$  and  $I_{BQ3}$  is positive only in the positive half period of the current for  $I_{BQ2}$  and in the negative half period for  $I_{BQ3}$ .

Capacitor C3 and C4 allow to hold V-forward during  $T_{off}$  of the switch Q1 hence ensure the base currents of Q2 and Q3. The base current of each transistor (Q1, Q3) however, can be negative during the half period of the mains, thanks to the forward of D5 and D12, this avoids possible turn-on of Q1 and Q3 when they must be off (Figure 6). The figure below shows the voltage control of the one freewheeling transistor and the collector current during  $T_{off}$  of the main switch.

Figure 6. Q2  $V_{be}$  control during positive half period of the Mains

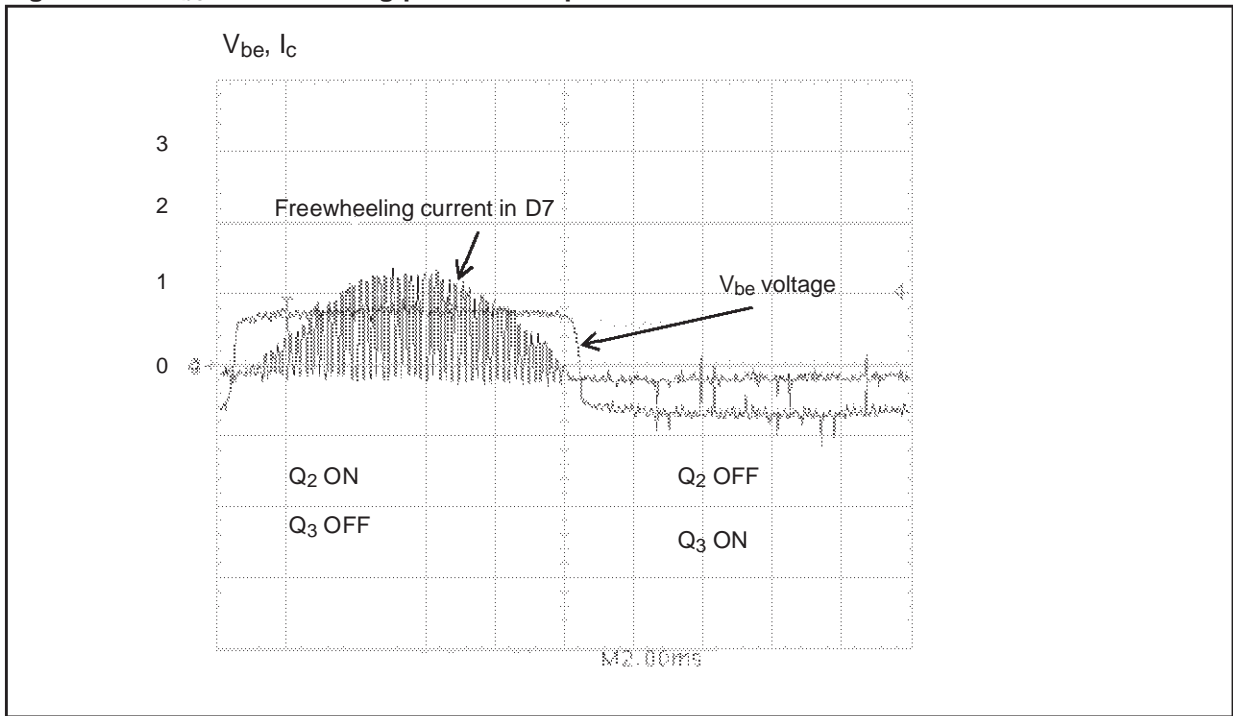
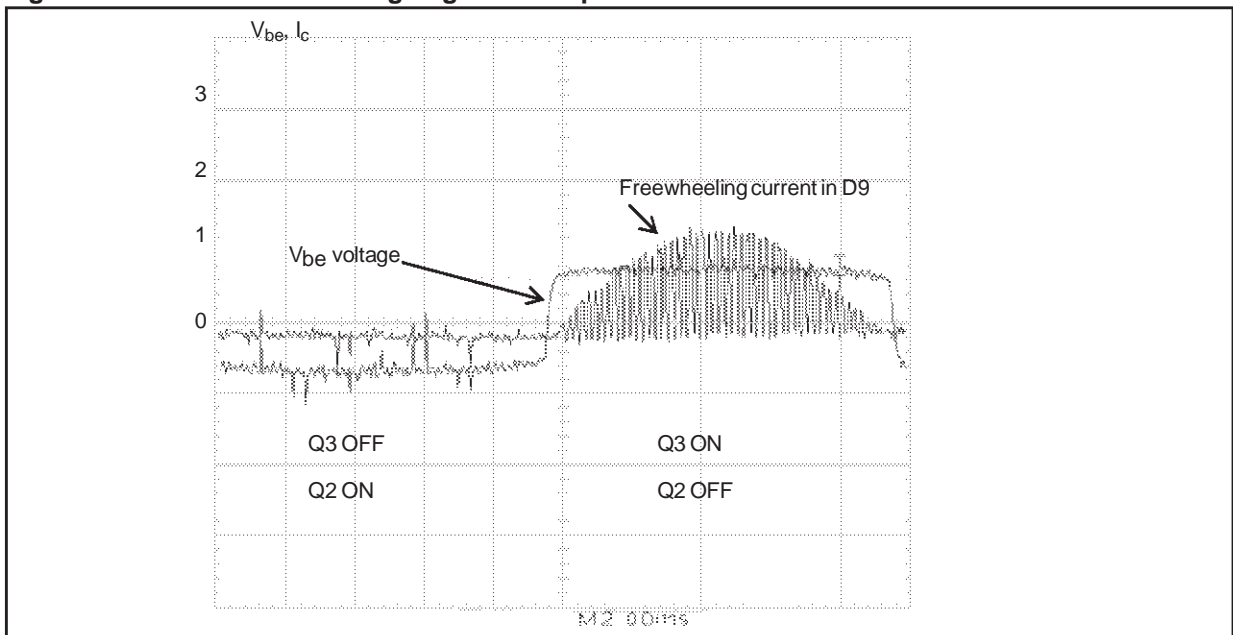

Figure 7. Q3  $V_{be}$  control during negative half period of the Mains



### HARDWARE IMPLEMENTATION

In the following schematic is shown the power section of the new solution driven by ST52x420 Microcontroller. The switching frequency is fixed at 20 KHz in pin 7 (Timer1 out), duty-cycle value establishes the power level in the motor. The peripheral PWM\_TIMER1 (as PWM\_TIMER0 and PWM\_TIMER2\_) allows in fact to produce a square wave signal, at a certain frequency (from 78.4 KHz to 1.2 Hz), with a programmable duty cycle from 0% to 100%. Therefore, varying the duty cycle it is possible to vary the power supplied to the motor.

An open loop control is implemented by using the potentiometer R7. As shown in figure 7, it is possible to fix a power level by variable resistor R7, connected to the analog input Ain0. The speed reference is obtained by changing the value as R7. This value is used to load the Timer register thus changing the duty-cycle. To avoid acoustic noise, the PWM is fixed at 20 KHZ and it is available in output in pin 7 (T1out). To drive the IGBT, the transistor Q4, Q5 and Q6 are implemented as level shifter. Instead of this solution, a driver like L638x series can be used.

Figure 8. Schematic of the board AB420\_2

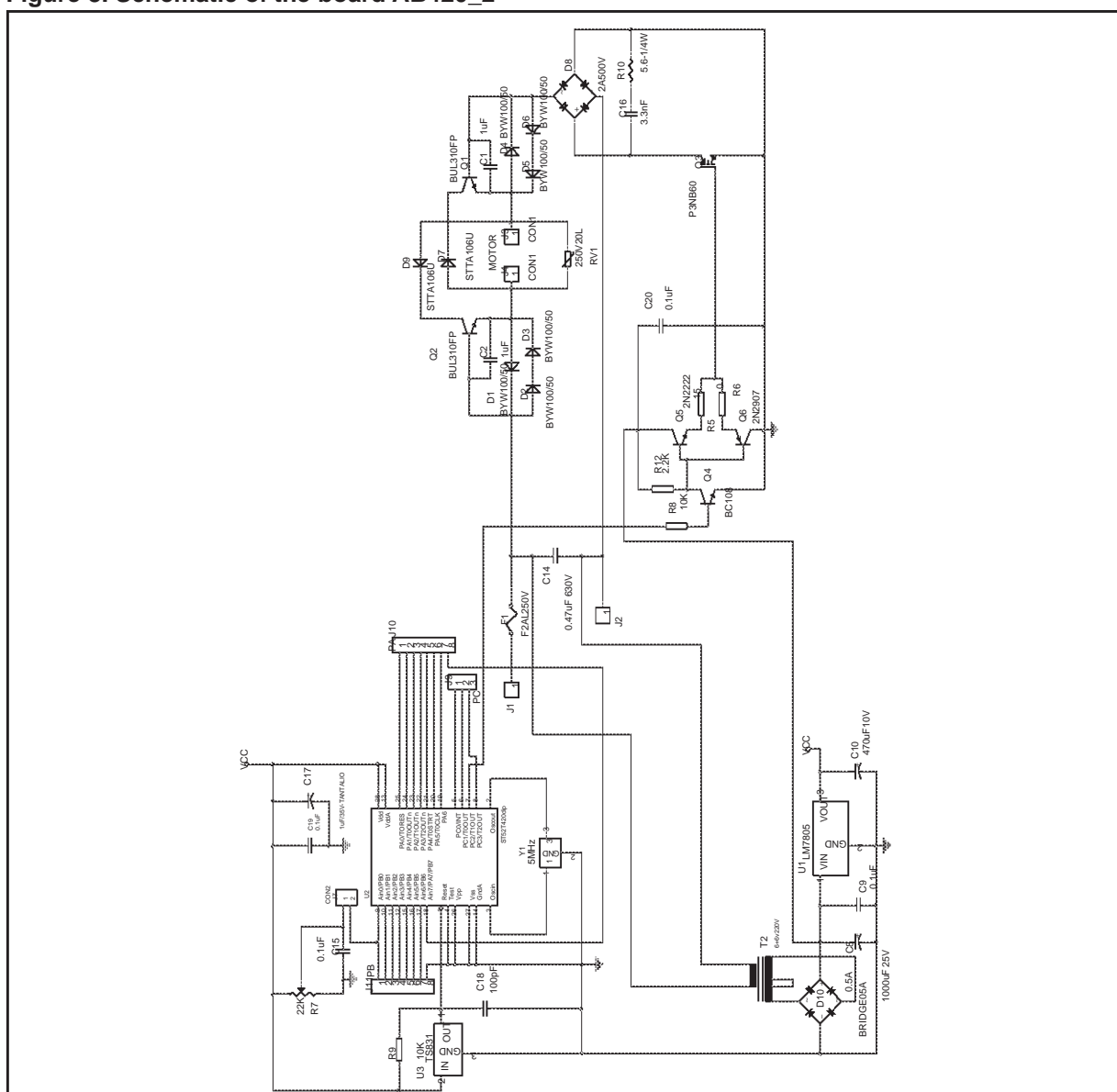

## AN1255 - APPLICATION NOTE

In case of closed loop control, it is possible to have all the I/Os of the microcontroller available (Figure 9), for example for a speed control loop or flux minimization of the AC motor for energy saving purposes.

Figure 9. PCB Board

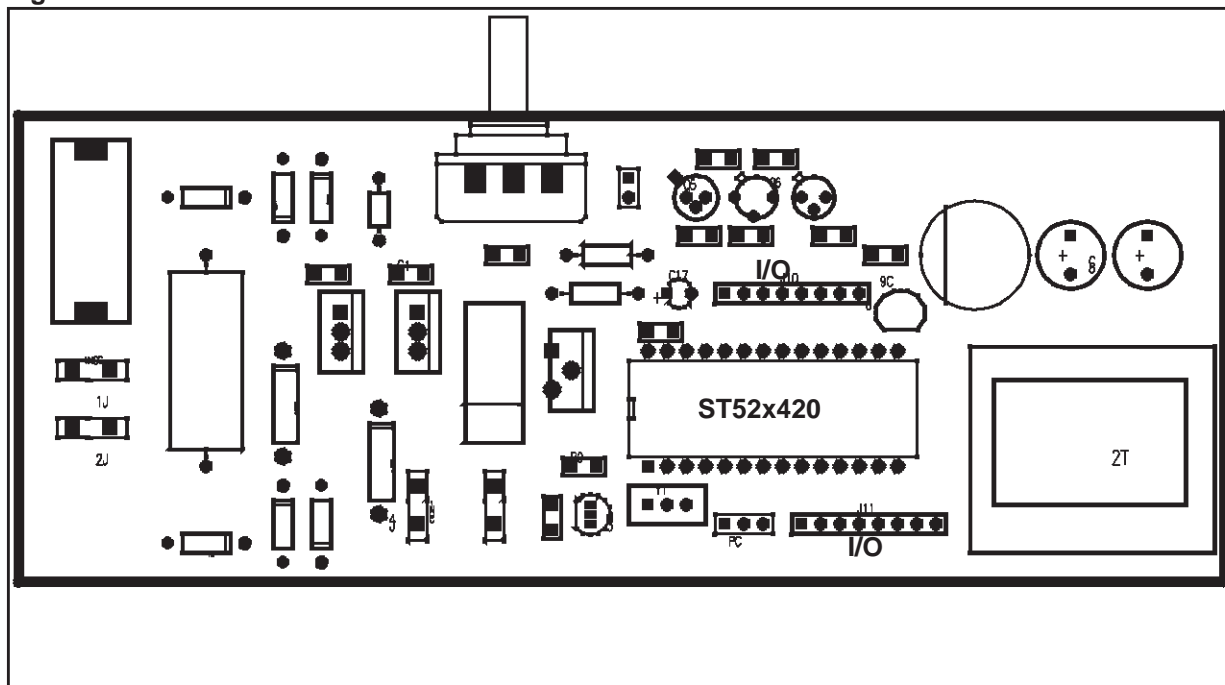
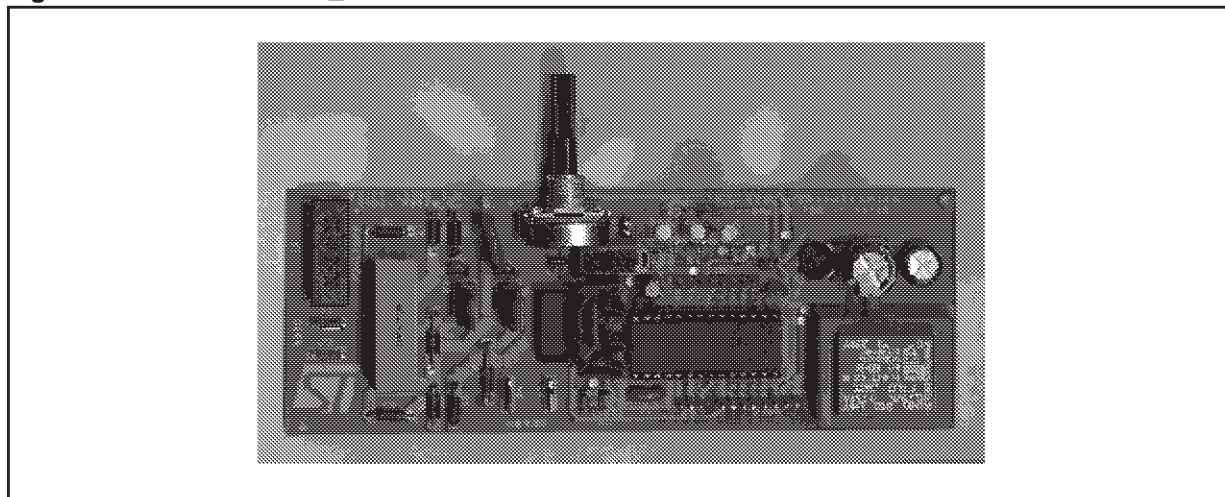

Figure 10. BOARD AB420\_2



**SOFTWARE DESCRIPTION**

The figure below shows the flowchart of the application and this can also be implemented by using FUZZYSTUDIO™4.0 as displayed in the following figures.

**Figure 11. Flowchart**

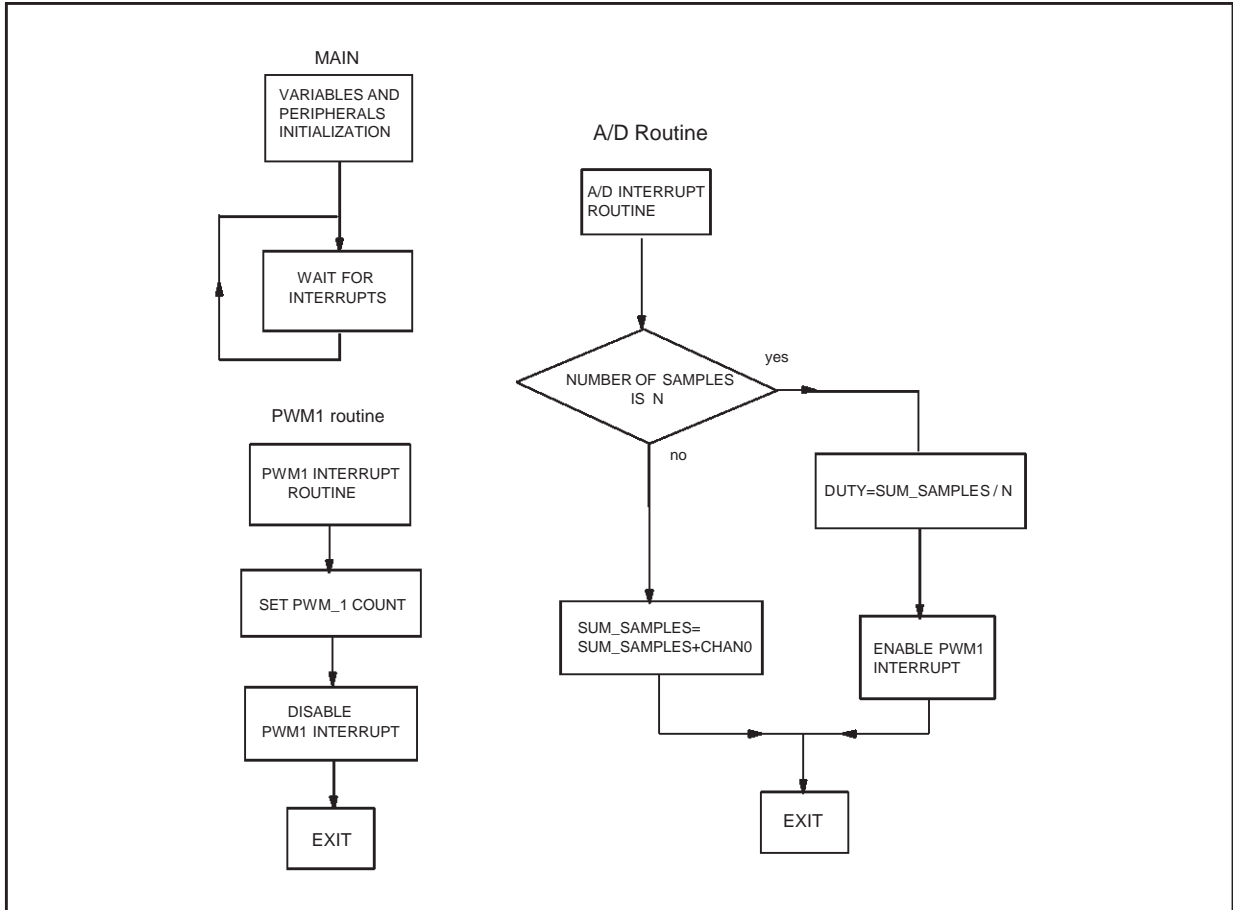

## AN1255 - APPLICATION NOTE

### Peripherals configuration

To fix the power supplied to the motor, it is necessary to vary the duty cycle of the signal Timer1; in order to avoid noise effect, this level is determined reading a mean value of voltage determined by the variable resistor R7.

In order to generate the PWM signal, the peripheral PWM/TIMER1 is used. This peripheral is configured to obtain a PWM signal at 19.2 KHz frequency and to send an interrupt request at each rising edge of the Timer1\_out\_signal, as you can see in the following figure:

Figure 12. Timer1 configuration

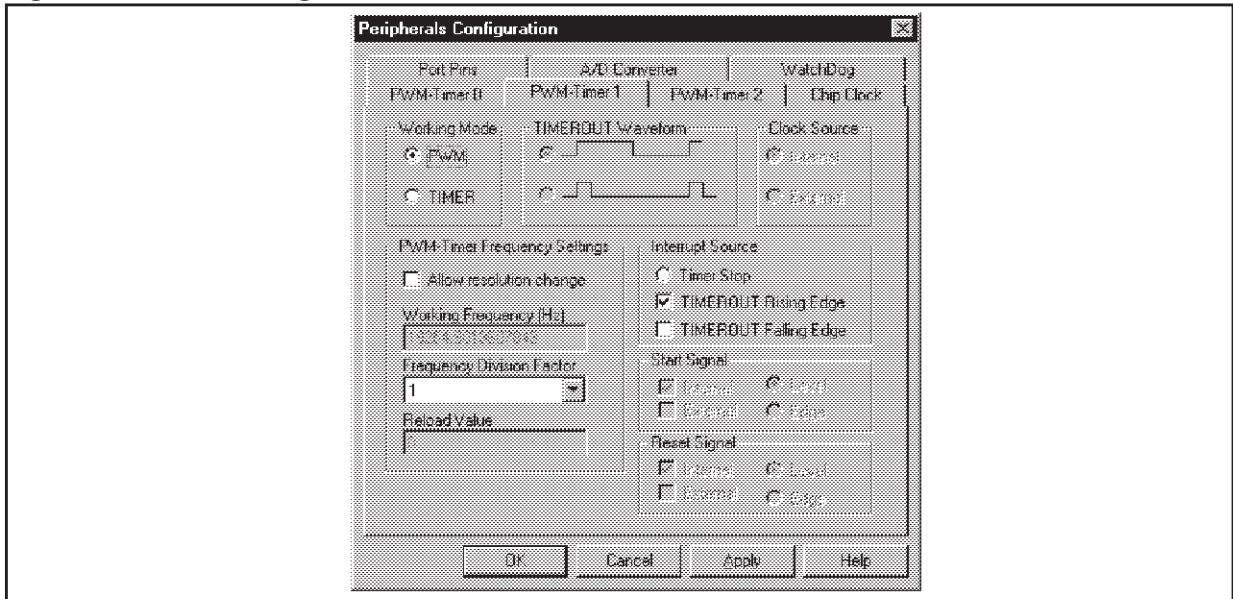

The voltage value determined by R7 is read by means of the A/D Converter peripheral configured with a single channel (Ain0) that is continually converted. The working frequency of the A/D Converter is obtained dividing by two the clock master frequency (5Mhz); the conversion is obtained each 32  $\mu$ s.

Figure 13. Port pin and A/D configuration

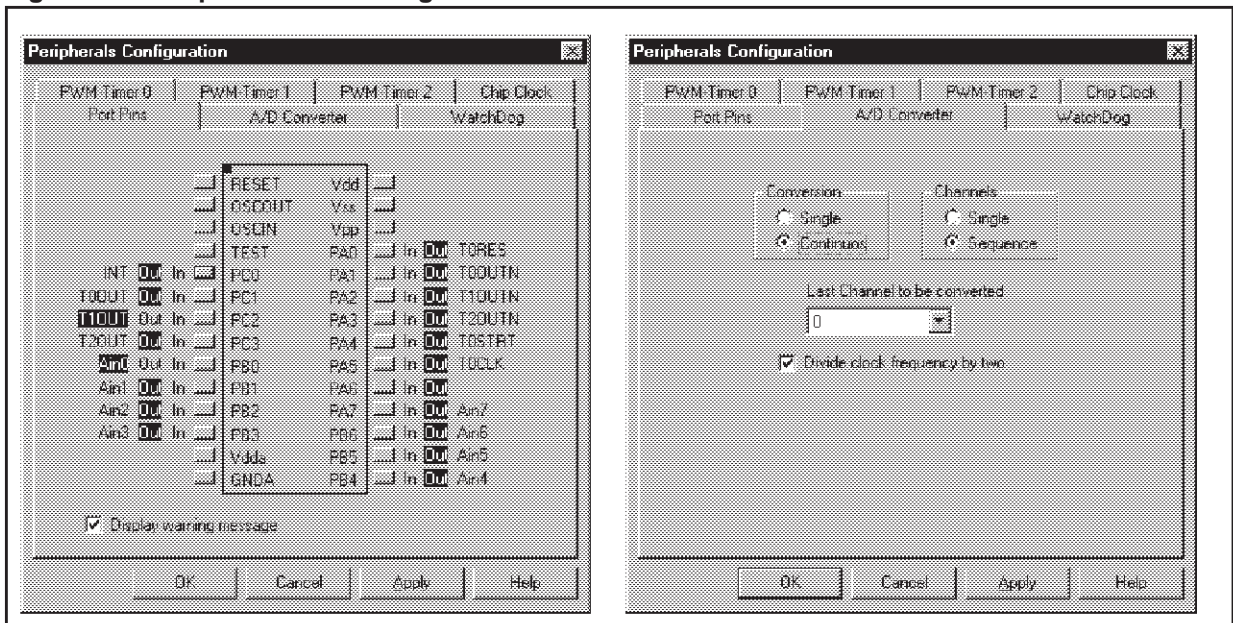



**Main Program Description**

The purpose of the main program is to initialize the variables used in this project, to enable the A/D and Timer1 interrupt and to start the A/D and Timer1 peripherals. The control action will be developed in the interrupt routines.

**Figure 14. FUZZYSTUDIO™ 4.0 Main Program window**

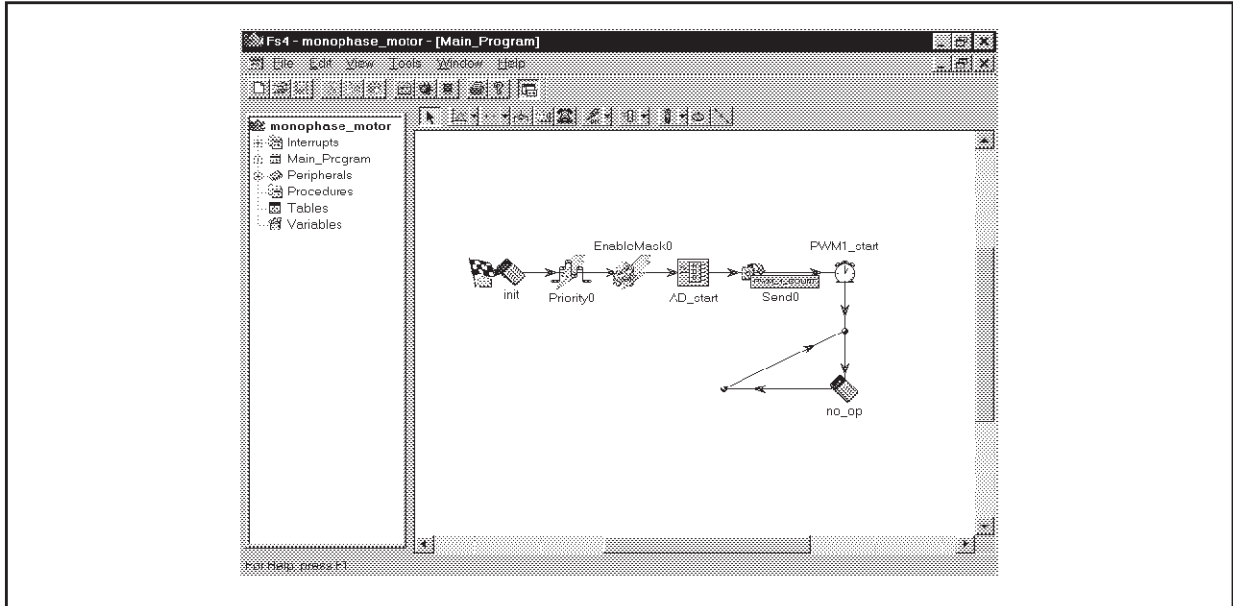

**Interrupt Routines description**

The purpose of the AD interrupt routine is to carry out an average arithmetic on N samples in order to filter noises on the analog channel. At every conversion, the value read on CHAN0 is added to a word type variable denominated 'sum\_samples', that at the end, after N conversions, will contain the sum of all the converted values. The mean value is obtained dividing by N then it is loaded in the duty variable. The loading of this variable in the counter PWM\_1\_COUNT is performed in the PWM1 interrupt routine only when the average has been calculated.

**Figure 15. A/D Converter Interrupt routine**

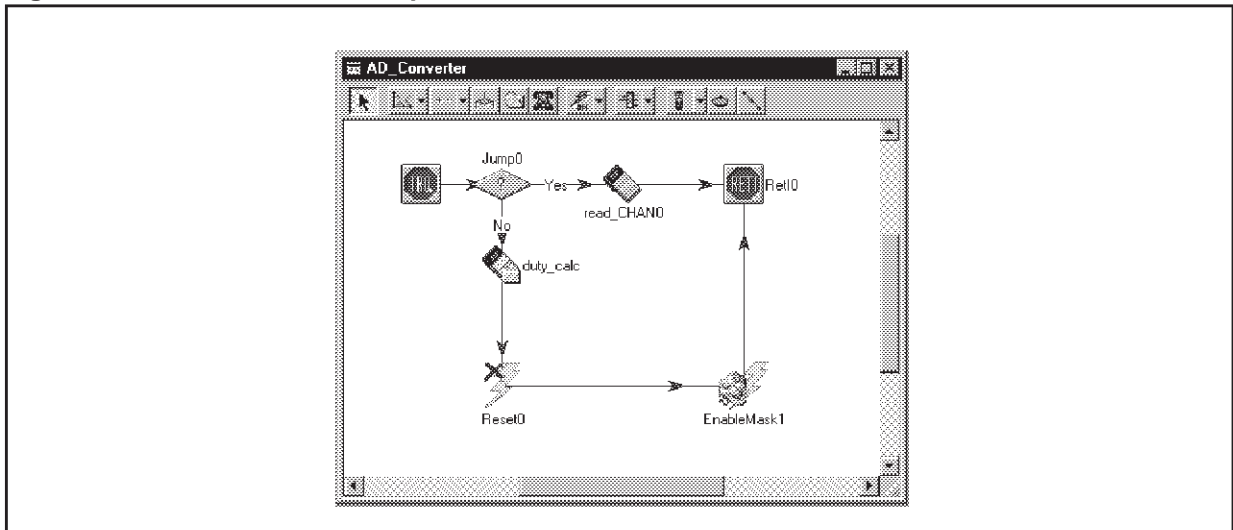
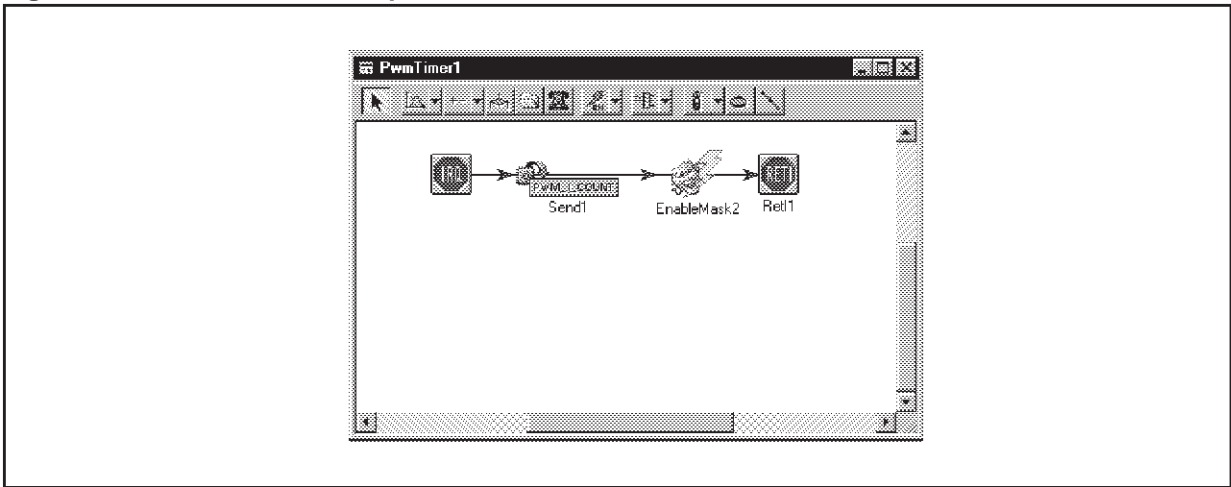

Figure 16. PWM Timer1 Interrupt routine



### CONCLUSION

The advantages offered by the proposed driver solution can be summarized in the following points:

- It allows a modulation where the third harmonic is limited, therefore noise reduction is observed with respect to phase partialization angle at low speed (Fig. 11, 13 and 14). The Voltage applied to the motor can be controlled linearly by changing the duty cycle of the PWM signal on transistor Q1. This allows to improve the control performances that can be obtained with respect to a simple phase angle control where the voltage applied to the motor is quadratic.
- If compared to the inverter driver solution, this driver does not need a separate power supply section. Due to the absence of AC/DC conversion, the filtering stage is smaller therefore less expensive than in the case of an inverter driver.
- Absence of torque pulsation with respect to phase partialization allows to reduce the vibrations of the mechanical support thus decreasing the acoustic noise.

Clearly a drawback of the proposed topology, with respect to the Inverter-based one, is that no Voltage/Frequency control can be done with obvious limitations on high speed control.

The following table shows the power contents of spurious harmonics introduced by the two different modulation techniques on a 0.2 kW monophasic motor (phase angle partialization control by using a triac versus PWM modulation allowed by the solution proposed in this application note). A constant load (with fixed speed) is applied to the motor.

Comparative Table

Harmonics Power Content			
	1 <sup>st</sup> (Watt)	3 <sup>rd</sup> (Watt)	5 <sup>th</sup> (Watt)
Triac Solution	150	28	12
New Proposed Solution	100	0.1	0.0

It is possible to notice that the proposed solution allows to optimize the system efficiency reducing losses generated by harmonic distortion as it occurs with the triac based regulation (Table).

Figures 11, 13 and 14 show the harmonic contents of motor current for the two techniques.

**Figure 17. Motor current harmonic contents with PWM technique and proposed solution**

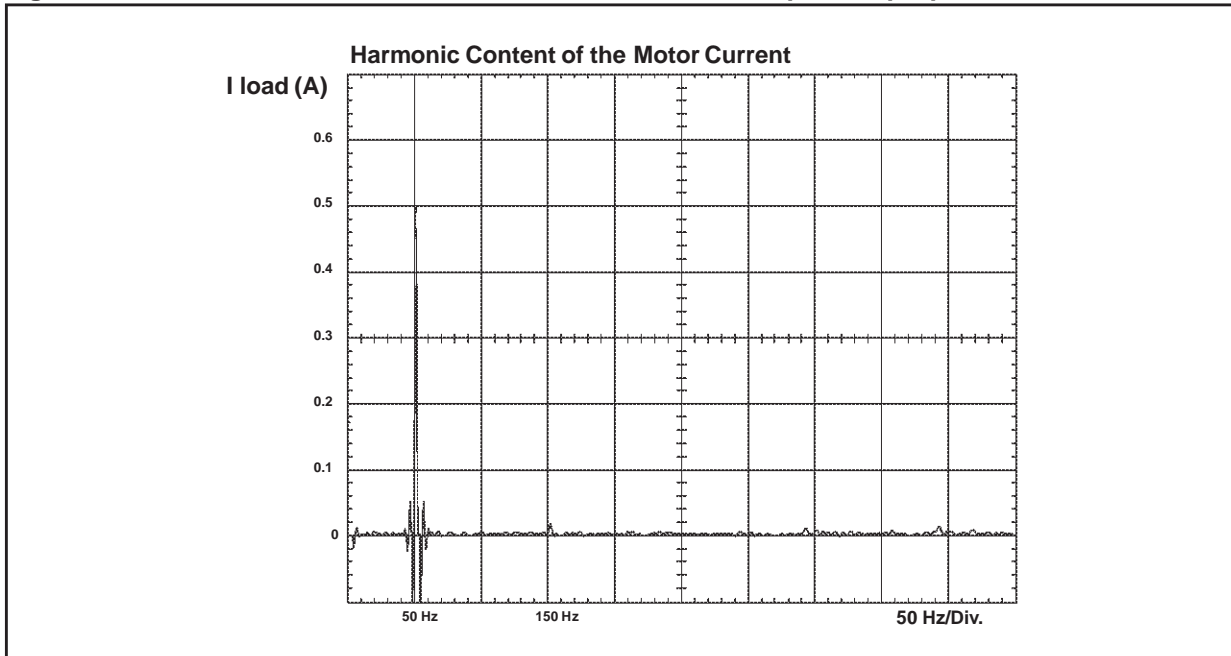

**Figure 18. Motor current and IGBT voltage with PWM technique and proposed solution**

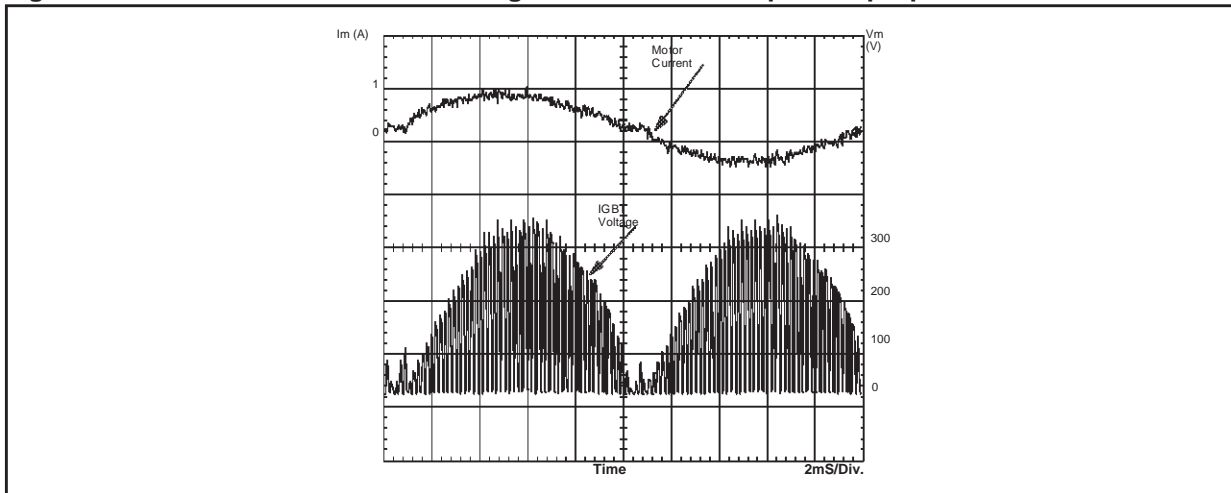

Figure 19. Motor current harmonic content with phase angle partialization technique

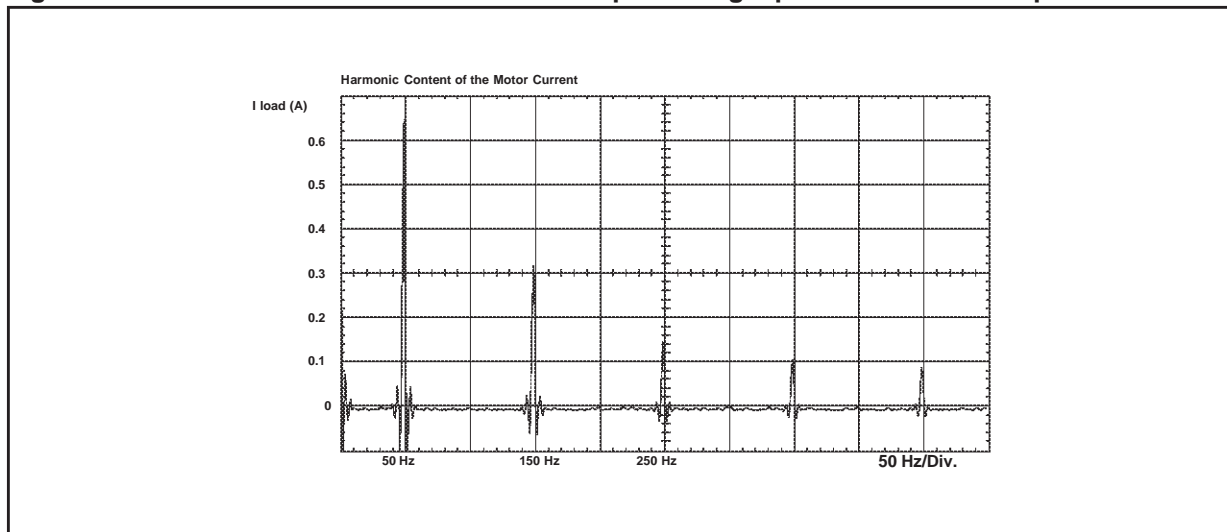

Figure 20. Motor current with phase angle partialization technique

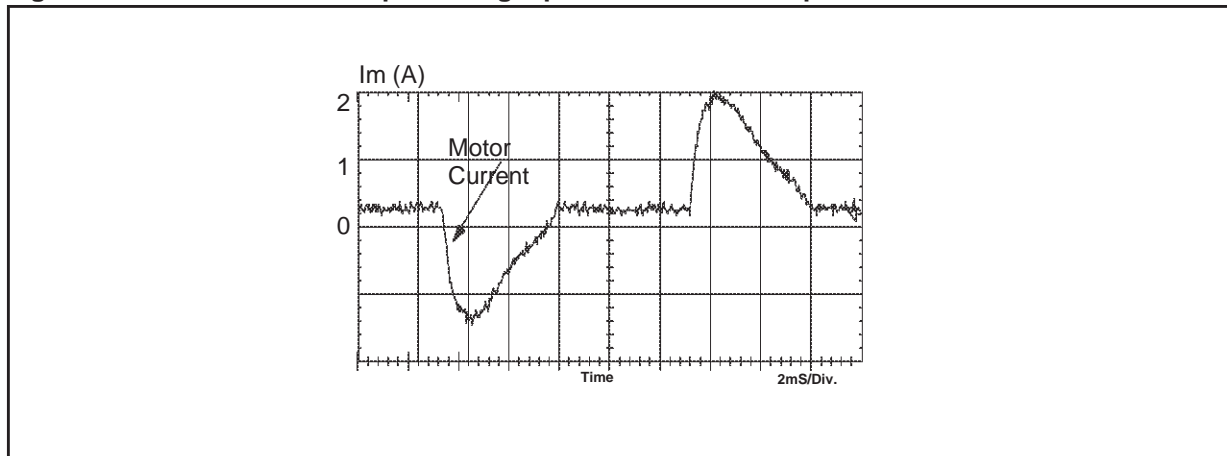
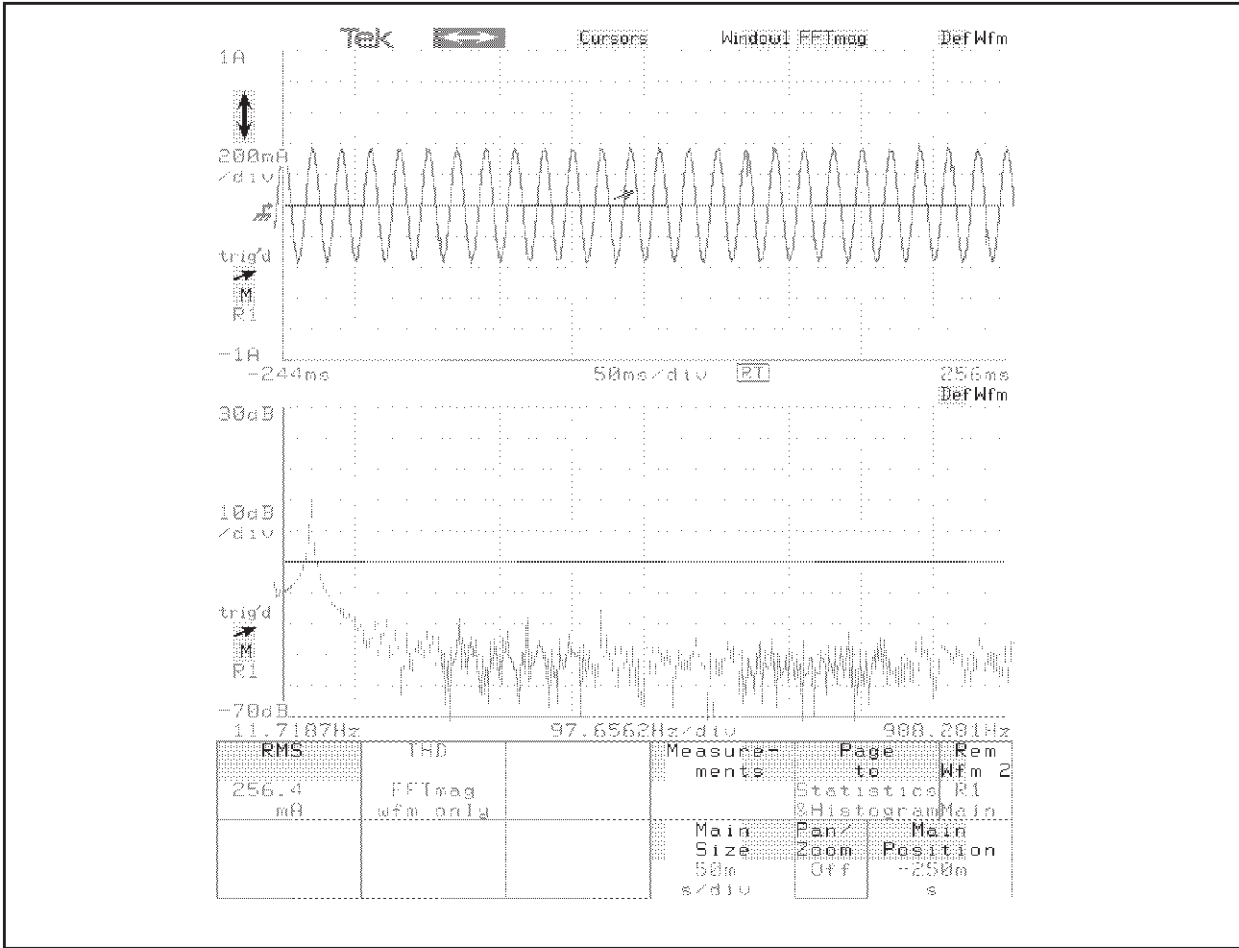
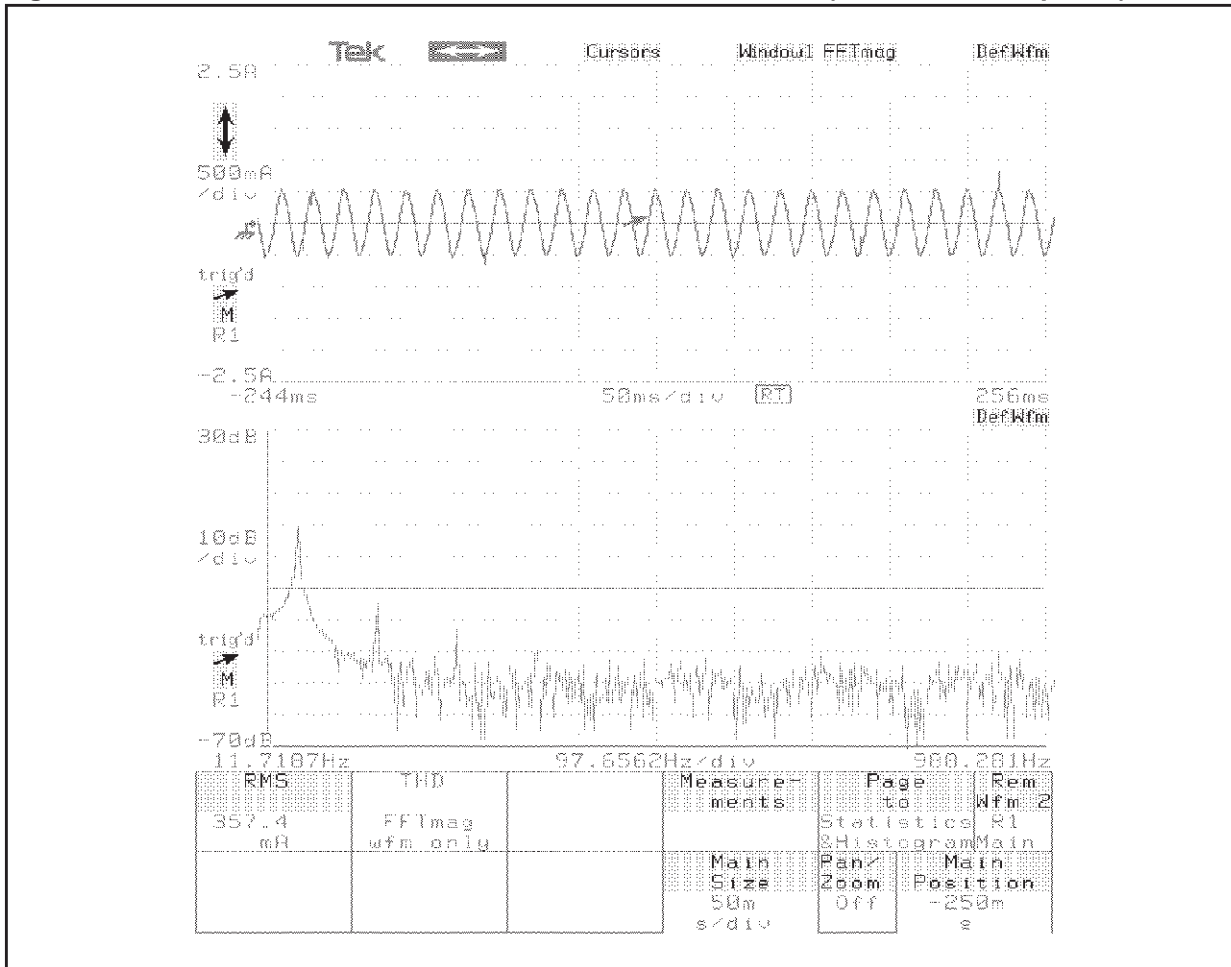

Figure 21. Motor current and FFT obtained with the new solution (25% of the total power)



## AN1255 - APPLICATION NOTE

Figure 22. Motor current and FFT obtained with the new solution (40% of the total power)



## REFERENCES

- ST52x420 Datasheet, STMicroelectronics , March 2000
- Mohan N., Undeland T. and Robbins W. "Power Electronics" . John Wiley & Sons, 1989
- Lo Presti M., Pagni A., Poluzzi R., Rizzotto GG. "Automatic synthesis, analysis and implementation of a fuzzy controller" by - IEEE Second International Conference On Fuzzy Systems", San Francisco (USA) - March 28 - April 1, 1993
- Lo Presti M., D'Angelo G. "A Fuzzy Control Strategy for different classes of Electrical Engine", Computer Design, 1994 International Technical Conference Series, San Diego, 13-15 September, 1994
- Leonhard W. "Control of Electrical Drives". Narosa Publishing House, New Delhi
- DiGuardo M., Vinci C. "Asynchronous Steuereing mit Fuzzy microcontrollern". Elektronik Informationen, Sept. 1999

For further information on the current application please refer to the file AN1255.fs4 designed with FUZZYSTUDIO™4.0 that can be downloaded from the **ST52 Fuzzy Microcontrollers** web site at the following address:

<http://www.st.com/stonline/prodpres>

"THE PRESENT NOTE WHICH IS FOR GUIDANCE ONLY AIMS AT PROVIDING CUSTOMERS WITH INFORMATION REGARDING THEIR PRODUCTS IN ORDER FOR THEM TO SAVE TIME. AS A RESULT, STMICROELECTRONICS SHALL NOT BE HELD LIABLE FOR ANY DIRECT, INDIRECT OR CONSEQUENTIAL DAMAGES WITH RESPECT TO ANY CLAIMS ARISING FROM THE CONTENT OF SUCH A NOTE AND/OR THE USE MADE BY CUSTOMERS OF THE INFORMATION CONTAINED HEREIN IN CONNECTION WITH THEIR PRODUCTS."

Information furnished is believed to be accurate and reliable. However, STMicroelectronics assumes no responsibility for the consequences of use of such information nor for any infringement of patents or other rights of third parties which may result from its use. No license is granted by implication or otherwise under any patent or patent rights of STMicroelectronics. Specification mentioned in this publication are subject to change without notice. This publication supersedes and replaces all information previously supplied. STMicroelectronics products are not authorized for use as critical components in life support devices or systems without express written approval of STMicroelectronics.

The ST logo is a trademark of STMicroelectronics

© 2000 STMicroelectronics - All Rights Reserved

FUZZYSTUDIO™ is a registered trademark of STMicroelectronics

STMicroelectronics GROUP OF COMPANIES

<http://www.st.com>

Australia - Brazil - China - Finland - France - Germany - Hong Kong - India - Italy - Japan - Malaysia - Malta - Morocco - Singapore - Spain - Sweden - Switzerland - United Kingdom - U.S.A.

