

# ELM77xxxB CMOS Dual voltage detector

www.DataSheet4U.com

## ■ General description

ELM77xxxB is CMOS dual voltage detector which consists of two comparator circuits watching V<sub>dd</sub> level and V<sub>det</sub> input level simultaneously and independently. With internal power-on control circuit, when V<sub>dd</sub> level is below 1.3V, the output of V<sub>det</sub> comparator of ELM77 series will be forced to “L”. For ELM77 series, V<sub>detn1</sub> is only available in 0.9V, 1.0V, 1.1V, 1.2V; the standard voltages of V<sub>detn2</sub> are 2.2V, 2.4V, 2.5V, 2.7V; ELM77 series can also be made as semi-custom IC within the detection voltage range of 2.2V~2.7V of V<sub>detn2</sub> by 0.1V step.

## ■ Features

- Detection voltage range : V<sub>detn1</sub> 0.9V, 1.0V, 1.1V, 1.2V  
V<sub>detn2</sub> 2.2V, 2.4V, 2.5V, 2.7V (by 0.1V)
- Low voltage operation : Reset operation assured at 0.8V
- Low current consumption : Typ. 1.5μA (ELM77274B, V<sub>dd</sub>=3.0V)
- Accuracy of detection voltage : V<sub>detn1</sub> ±3.0%  
V<sub>detn2</sub> ±2.5%
- Power on reset voltage : Typ. 1.3V
- Temperature coefficient : ±250ppm/°C
- Output form : N-ch opendrain
- Package : SOT-25

## ■ Application

- Reset for microcomputers
- Power voltage shortage detectors
- Switch of backup power source
- Battery checkers

## ■ Maximum absolute ratings

Parameter	Symbol	Limit	Unit
Power supply voltage	V <sub>dd</sub>	10	V
Input voltage (for detection voltage)	V <sub>det</sub>	10	V
Output voltage	V <sub>out1</sub>	V <sub>SS</sub> -0.3~+10	V
	V <sub>out2</sub>		
Output current	I <sub>out1</sub>	25	mA
	I <sub>out2</sub>		
Power dissipation	P <sub>d</sub>	300	mW
Operationg temperature	T <sub>op</sub>	-40~+85	°C
Storage temperature	T <sub>stg</sub>	-55~+125	°C

## ■ Selection guide

ELM77xxxB-x

Symbol		
a,b	Detection voltage2	e.g. : 22: V <sub>detn2</sub> =2.2V    24: V <sub>detn2</sub> =2.4V 25: V <sub>detn2</sub> =2.5V    27: V <sub>detn2</sub> =2.7V
c	Detection voltage1	e.g. : 1 : V <sub>detn1</sub> =0.9V    2 : V <sub>detn1</sub> =1.0V 3 : V <sub>detn1</sub> =1.1V    4 : V <sub>detn1</sub> =1.2V
d	Product version	B
e	Taping direction	S : Refer to PKG file N : Refer to PKG file

ELM77 x x x B - x  
 ↑ ↑ ↑ ↑ ↑  
 a b c d e

## Pin configuration

SOT-25 (TOP VIEW)

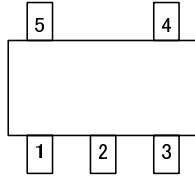

Pin No.	Pin name
1	OUT1
2	VDD
3	VSS
4	VDET
5	OUT2

## Timing chart

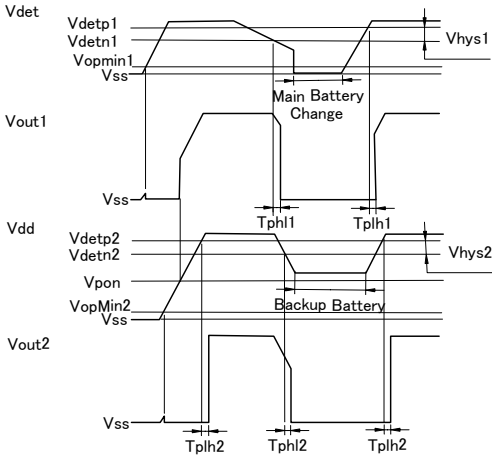

## Block diagram

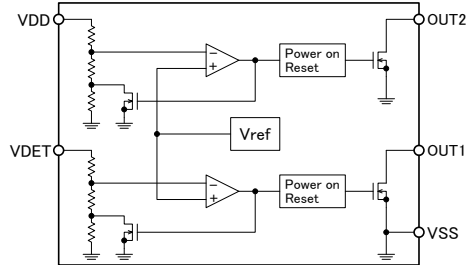

www.DataSheet4U.com

## e.g.) Circuit

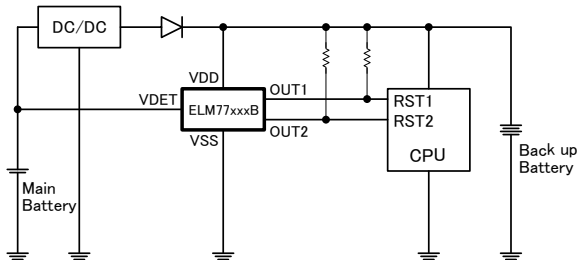

## ■ Electrical characteristics

## ELM77221B

Top=25°C

Parameter	Symbol	Condition	Min.	Typ.	Max.	Unit	Note
Detection voltage1	Vdetn1	Vdd=1.5V, Pullup 3.0V, R=1MΩ	0.873	0.900	0.927	V	2
Detection voltage2	Vdetn2	Pullup 3.0V, R=1MΩ	2.145	2.200	2.255	V	2
Hysteresis width1	Vhys1			Vdetn1 ×0.03		V	2
Hysteresis width2	Vhys2			Vdetn2 ×0.05		V	2
Current consumption	I <sub>ss</sub>	Vdd=3.0V		2.0	6.0	μA	1
Power voltage	Vdd		0.8		6.0	V	2
Output current1	I <sub>outn1</sub>	Vdd=0.8V, Vds=0.5V	0.005	0.100		mA	3
Output current2	I <sub>outn2</sub>	Vdd=1.5V, Vds=0.5V	1.0	3.0		mA	3
Power on reset voltage	V <sub>pon</sub>	*1	1.15	1.30	1.45	V	2
Input voltage (for detection voltage)	Vdet	1.5V ≤ Vdd	0		≤ Vdd	V	4
Input current	I <sub>det</sub>	Vdd=Vdet=1.5V		0.7		μA	4
Delay time1	T <sub>phl1</sub>			0.4		ms	5-(1)
Delay time2	T <sub>phl2</sub>			0.6		ms	5-(2)
Temperature characteristic of Vdetn	$\frac{\Delta V_{detn}}{\Delta T_{op}}$	T <sub>op</sub> =-40~+85°C		±250		ppm/°C	

\* Note : test circuit No.

\* 1 : Vdetn1 output is forced to "L" when or if Vdd is lower than Vpon voltage represent.

## ELM77242B

Top=25°C

Parameter	Symbol	Condition	Min.	Typ.	Max.	Unit	Note
Detection voltage1	Vdetn1	Vdd=1.5V, Pullup 3.0V, R=1MΩ	0.970	1.000	1.030	V	2
Detection voltage2	Vdetn2	Pullup 3.0V, R=1MΩ	2.340	2.400	2.460	V	2
Hysteresis width1	Vhys1			Vdetn1 ×0.03		V	2
Hysteresis width2	Vhys2			Vdetn2 ×0.05		V	2
Current consumption	I <sub>ss</sub>	Vdd=3.0V		1.5	5.0	μA	1
Power voltage	Vdd		0.8		6.0	V	2
Output current1	I <sub>outn1</sub>	Vdd=0.8V, Vds=0.5V	0.005	0.100		mA	3
Output current2	I <sub>outn2</sub>	Vdd=1.5V, Vds=0.5V	1.0	3.0		mA	3
Power on reset voltage	V <sub>pon</sub>	*1	1.15	1.30	1.45	V	2
Input voltage (for detection voltage)	Vdet	1.5V ≤ Vdd	0		≤ Vdd	V	4
Input current	I <sub>det</sub>	Vdd=Vdet=1.5V		0.7		μA	4
Delay time1	T <sub>phl1</sub>			0.4		ms	5-(1)
Delay time2	T <sub>phl2</sub>			0.6		ms	5-(2)
Temperature characteristic of Vdetn	$\frac{\Delta V_{detn}}{\Delta T_{op}}$	T <sub>op</sub> =-40~+85°C		±250		ppm/°C	

\* Note : test circuit No.

\* 1 : Vdetn1 output is forced to "L" when or if Vdd is lower than Vpon voltage represent.

# ELM77xxxB CMOS Dual voltage detector

www.DataSheet4U.com

## ELM77253B

Top=25°C

Parameter	Symbol	Condition	Min.	Typ.	Max.	Unit	Note
Detection voltage1	Vdetn1	Vdd=1.5V, Pullup 3.0V, R=1MΩ	1.067	1.100	1.133	V	2
Detection voltage2	Vdetn2	Pullup 3.0V, R=1MΩ	2.437	2.500	2.563	V	2
Hysteresis width1	Vhys1			Vdetn1 ×0.03		V	2
Hysteresis width2	Vhys2			Vdetn2 ×0.05		V	2
Current consumption	I <sub>ss</sub>	Vdd=3.0V		1.5	5.0	μA	1
Power voltage	Vdd		0.8		6.0	V	2
Output current1	Ioutn1	Vdd=0.8V, Vds=0.5V	0.005	0.100		mA	3
Output current2	Ioutn2	Vdd=1.5V, Vds=0.5V	1.0	3.0		mA	3
Power on reset voltage	Vpon	*1	1.15	1.30	1.45	V	2
Input voltage (for detection voltage)	Vdet	1.5V ≤ Vdd	0		≤ Vdd	V	4
Input current	I <sub>det</sub>	Vdd=Vdet=1.5V		0.7		μA	4
Delay time1	T <sub>phl1</sub>			0.4		ms	5-(1)
Delay time2	T <sub>phl2</sub>			0.6		ms	5-(2)
Temperature characteristic of Vdetn	$\frac{\Delta V_{detn}}{\Delta Top}$	Top=-40~+85°C		±250		ppm/°C	

\* Note : test circuit No.

\* 1 : Vdetn1 output is forced to "L" when or if Vdd is lower than Vpon voltage represent.

## ELM77274B

Top=25°C

Parameter	Symbol	Condition	Min.	Typ.	Max.	Unit	Note
Detection voltage1	Vdetn1	Vdd=1.5V, Pullup 3.0V, R=1MΩ	1.164	1.200	1.236	V	2
Detection voltage2	Vdetn2	Pullup 3.0V, R=1MΩ	2.632	2.700	2.768	V	2
Hysteresis width1	Vhys1			Vdetn1 ×0.03		V	2
Hysteresis width2	Vhys2			Vdetn2 ×0.05		V	2
Current consumption	I <sub>ss</sub>	Vdd=3.0V		1.5	5.0	μA	1
Power voltage	Vdd		0.8		6.0	V	2
Output current1	Ioutn1	Vdd=0.8V, Vds=0.5V	0.005	0.100		mA	3
Output current2	Ioutn2	Vdd=1.5V, Vds=0.5V	1.0	3.0		mA	3
Power on reset voltage	Vpon	*1	1.15	1.30	1.45	V	2
Input voltage (for detection voltage)	Vdet	1.5V ≤ Vdd	0		≤ Vdd	V	4
Input current	I <sub>det</sub>	Vdd=Vdet=1.5V		0.7		μA	4
Delay time1	T <sub>phl1</sub>			0.4		ms	5-(1)
Delay time2	T <sub>phl2</sub>			0.6		ms	5-(2)
Temperature characteristic of Vdetn	$\frac{\Delta V_{detn}}{\Delta Top}$	Top=-40~+85°C		±250		ppm/°C	

\* Note : test circuit No.

\* 1 : Vdetn1 output is forced to "L" when or if Vdd is lower than Vpon voltage represent.

## Test circuits

1) Current consumption

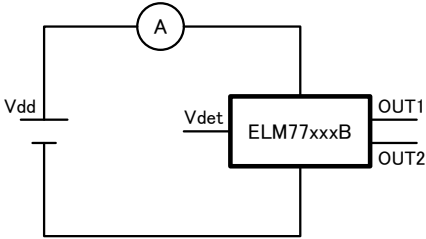

2) Detection voltage

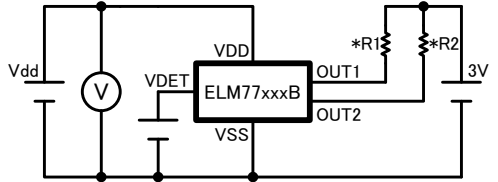

\* R=1MΩ

3) Output current (N-ch)

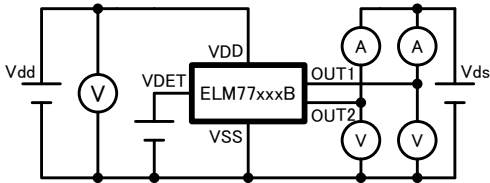

4) Input current

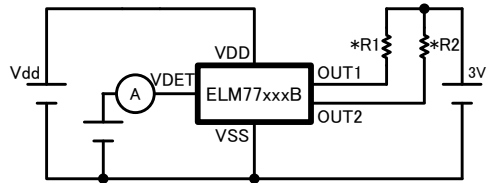

\* R=1MΩ

5)-(1) Delay time (1)

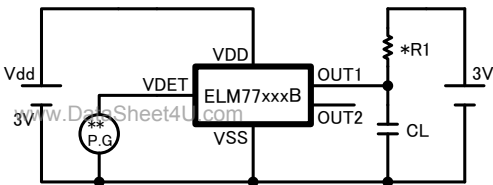

\* R1=1MΩ

5)-(2) Delay time (2)

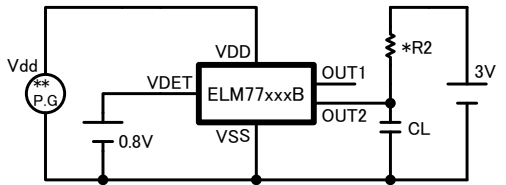

\* R2=1MΩ

\*\* Input pulse

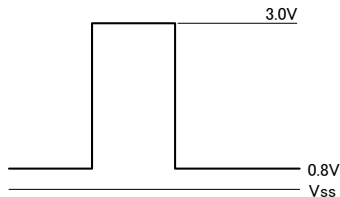

## Marking

SOT-25

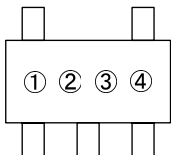

No. ① : the detection voltage1

Mark	Vdetn1	Mark	Vdetn1
A	0.9V	C	1.1V
B	1.0V	D	1.2V

No. ② : the detection voltage2

Mark	Vdetn2	Mark	Vdetn2
2	2.2V	5	2.5V
3	2.3V	6	2.6V
4	2.4V	7	2.7V

No. ③ : Assembly lot No.

A~Z (I, O, X excepted)

No. ④ : Assembly lot No.

0~9

## Current consumption characteristics

• ELM77221B

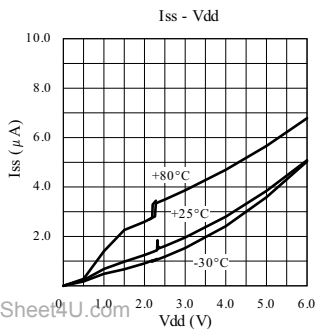

• ELM77242B

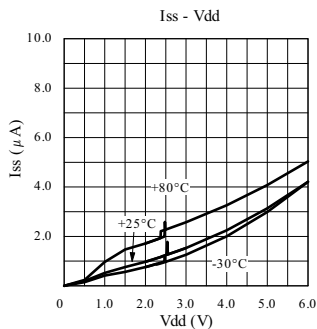

• ELM77253B

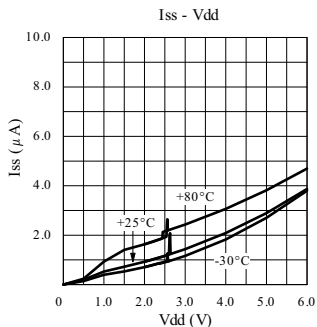

• ELM77274B

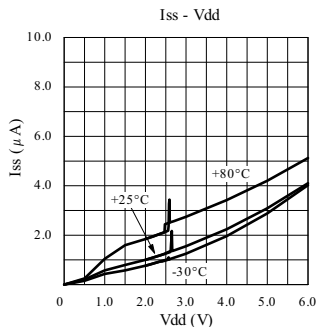

## ■ Detection voltage characteristics (Vdetn1)

- ELM77xx1B

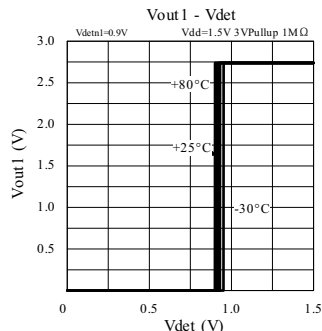
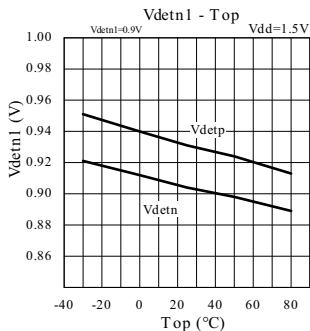

- ELM77xx2B

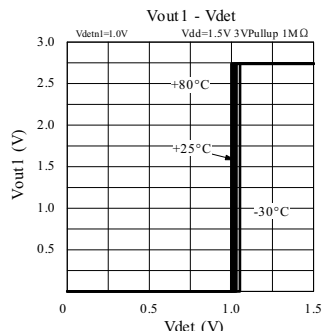
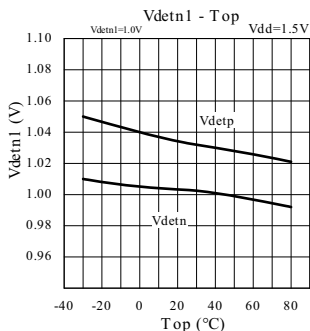

- ELM77xx3B

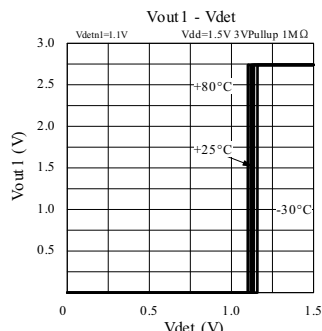
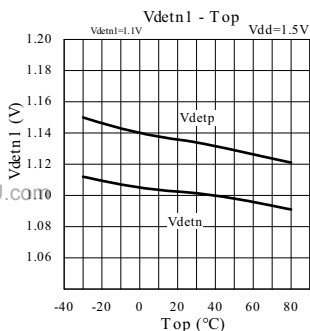

www.DataSheet4U.com

- ELM77xx4B

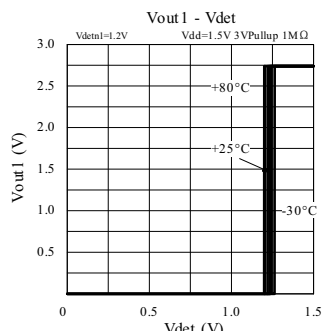
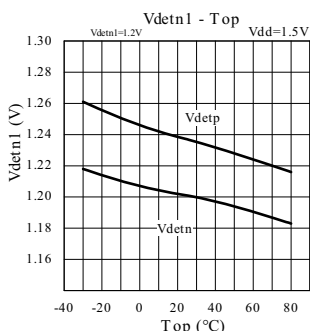

## ■ Detection voltage characteristics (Vdetn2)

- ELM7722xB

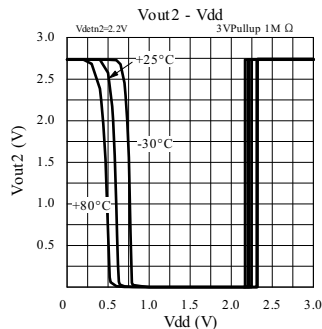
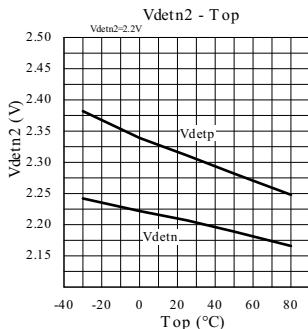

- ELM7724xB

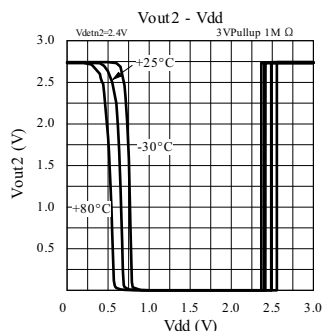
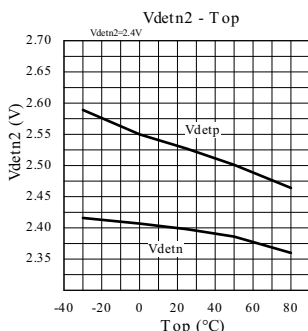

- ELM7725xB

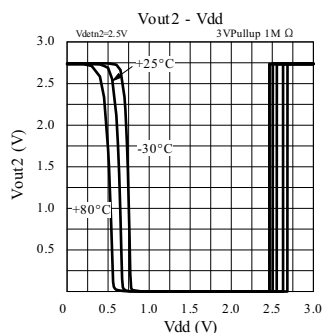
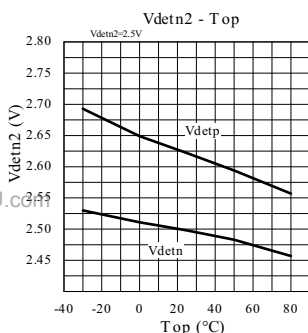

- ELM7727xB

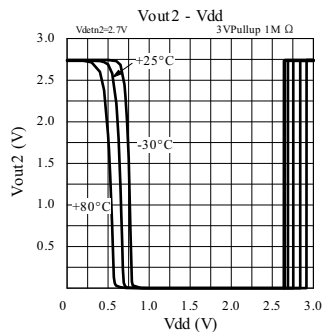
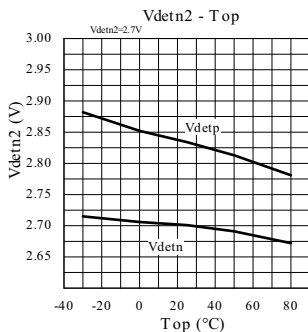



## Power on reset voltage

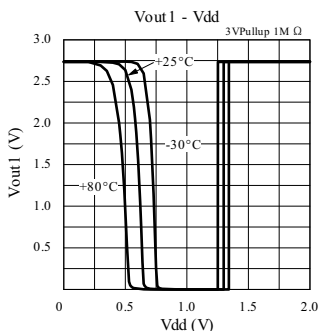

## Output current characteristics1 (Ioutn1)

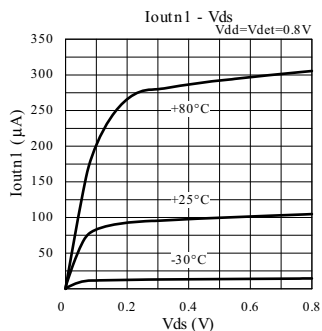
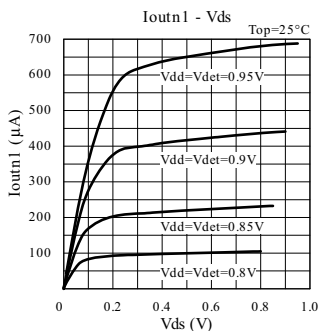

www.DataSheet4U.com

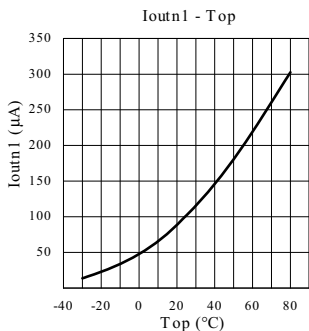

## Output current characteristics2 (Ioutn2)

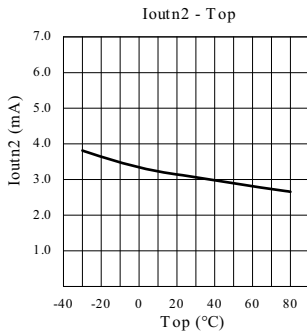
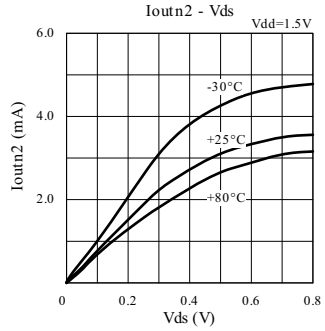
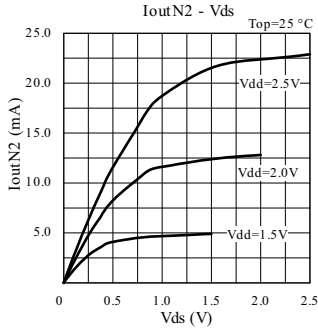

## Input current characteristics

www.DataSheet4U.com

• ELM77xx1B

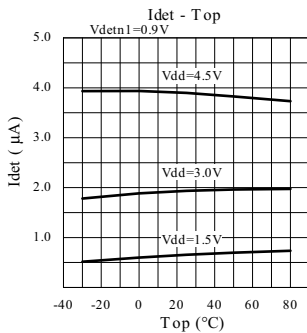

• ELM77xx2B

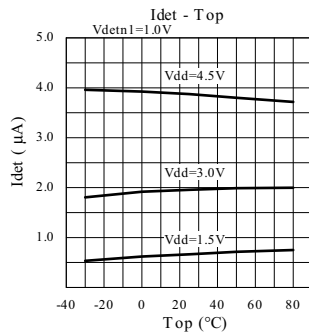

• ELM77xx3B

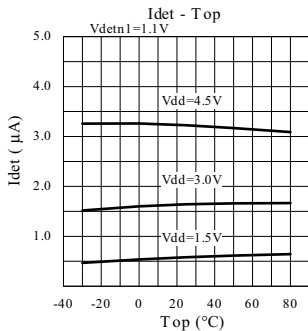

• ELM77xx4B

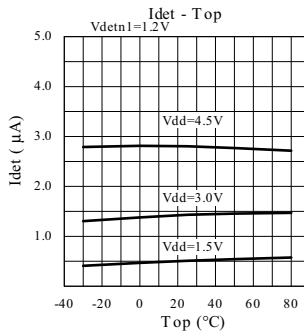

■ Propagation delay time characteristics

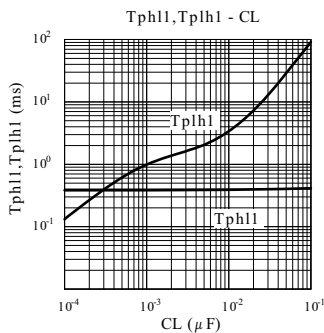
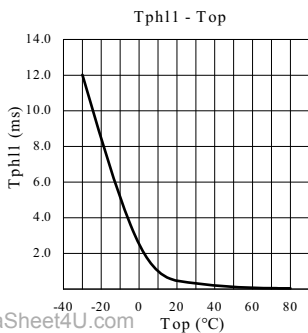

www.DataSheet4U.com

