

# Current Transducer HAIS 50..400-P and HAIS 50..100-TP

$$I_{PN} = 50 \dots 400 \text{ A}$$

For the electronic measurement of currents : DC, AC, pulsed, mixed, with a galvanic isolation between the primary circuit (high power) and the secondary circuit (electronic circuit).



All Data are given with a  $R_L = 10 \text{ k}\Omega$



## Electrical data

Primary nominal current rms $I_{PN}$ (A)	Primary current, measuring range $I_{PM}$ (A)	Type	RoHS since date code
50	$\pm 150$	HAIS 50-P, HAIS 50-TP <sup>1)</sup>	45231, 46272
100	$\pm 300$	HAIS 100-P, HAIS 100-TP <sup>1)</sup>	45231, 46012
150	$\pm 450$	HAIS 150-P	46172
200	$\pm 600$	HAIS 200-P	45231
400	$\pm 600$	HAIS 400-P	planned

$V_{OUT}$	Output voltage (Analog) @ $I_P$ $I_P = 0$	$V_{REF} \pm (0.625 \cdot I_P / I_{PN})$ V $V_{REF} \pm 0.025$ V
$V_{REF}$	Reference voltage <sup>2)</sup> - Output voltage	$2.5 \pm 0.025$ V
	$V_{REF}$ Output impedance	typ. 200 $\Omega$
	$V_{REF}$ Load impedance	$\geq 200$ k $\Omega$
$R_L$	Load resistance	$\geq 2$ k $\Omega$
$R_{OUT}$	Output internal resistance	$< 10$ $\Omega$
$C_L$	Capacitive loading	$< 1$ $\mu$ F
$V_C$	Supply voltage ( $\pm 5$ %)	5 V
$I_C$	Current consumption @ $V_C = 5$ V	22 mA

## Accuracy - Dynamic performance data

X	Accuracy <sup>3)</sup> @ $I_{PN}$ , $T_A = 25^\circ\text{C}$	$\leq \pm 1$	% of $I_{PN}$
$e_L$	Linearity error $0 \dots 3 \times I_{PN}$	$\leq \pm 0.5$	% of $I_{PN}$
$TCV_{OE}$	Temperature coefficient of $V_{OE}$ @ $I_P = 0$	$\leq \pm 0.3$	mV/K
$TCV_{REF}$	Temperature coefficient of $V_{REF}$	$\leq \pm 0.01$	%/K
$TCV_{OUT}/V_{REF}$	Temperature coefficient of $V_{OUT}/V_{REF}$ @ $I_P = 0$	$\leq \pm 0.2$	mV/K
$TCV_{OUT}$	Temperature coefficient of $V_{OUT}$	$\leq \pm 0.05\%$	of reading/K
$V_{OM}$	Magnetic offset voltage @ $I_P = 0$ , after an overload of $3 \times I_{PN DC}$	$< \pm 0.4$	% of $I_{PN}$
$t_{ra}$	Reaction time @ 10 % of $I_{PN}$	$< 3$	$\mu$ s
$t_r$	Response time to 90 % of $I_{PN}$ step	$< 5$	$\mu$ s
di/dt	di/dt accurately followed	$> 100$	A/ $\mu$ s
$V_{no}$	Output voltage noise (DC .. 10 kHz)	$< 15$	mVpp
	(DC .. 1 MHz)	$< 40$	mVpp
BW	Frequency bandwidth (-3 dB) <sup>4)</sup>	DC .. 50	kHz

## Features

- Hall effect measuring principle
- Galvanic isolation between primary and secondary circuit
- Isolation test voltage 2500V
- Low power consumption
- Single power supply +5V
- Fixed offset & gain
- Bus bar version available for 50A and 100A ratings.
- Insulated plastic case recognized according to UL94-V0.

## Advantages

- Small size and space saving
- Only one design for wide current ratings range
- High immunity to external interference.
- $V_{REF}$  IN/OUT

## Applications

- AC variable speed drives
- Static converters for DC motor drives
- Battery supplied applications
- Uninterruptible Power Supplies (UPS)
- Switched Mode Power Supplies (SMPS)
- Power supplies for welding applications.

## Application Domain

- Industrial

Notes : <sup>1)</sup> -TP version is equipped with a primary bus bar.

<sup>2)</sup> It is possible to overdrive  $V_{REF}$  with an external reference voltage between 2 - 2.8 V providing its ability to sink or source approximately 2.5 mA.

<sup>3)</sup> Excluding offset and hysteresis.

<sup>4)</sup> Small signal only to avoid excessive heatings of the magnetic core.

## Current Transducer HAIS 50..400-P and HAIS 50..100-TP

### General data

$T_A$	Ambient operating temperature	- 40 .. + 85	°C
$T_S$	Ambient storage temperature	- 40 .. + 85	°C
$m$	Mass (in brackets : TP version) Standards	20 (30) EN 50178: 1997	g

### Isolation characteristics

$V_b$	Rated isolation voltage rms with IEC 61010-1 standards and following conditions - Single insulation - Over voltage category III - Pollution degree 2 - Heterogeneous field	300	V rms
$V_b$	Rated isolation voltage rms with EN 50178 standards and following conditions - Reinforced insulation - Over voltage category III - Pollution degree 2 - Heterogeneous field	600	V rms
$V_d$	Rms voltage for AC isolation test, 50 Hz, 1 min	2.5	kV
$V_e$	Partial discharge extinction voltage rms @ 10pC		
		HAIS 50..400-P	> 1 kV
		HAIS 50..100-TP	> 1.4 kV
$\hat{V}_w$	Impulse withstand voltage 1.2/50 $\mu$ s	8	kV
dCp	Creepage distance	> 8	mm
dCl	Clearance distance	> 8	mm
CTI	Comparative tracking index (Group I)	> 600	

If insulated cable is used for the primary circuit, the voltage category could be improved with the following table :

Cable insulation (primary)	Category
HAR 03	450V CAT III
HAR 05	550V CAT III
HAR 07	650V CAT III

### Safety



This transducer must be used in electric/electronic equipment with respect to applicable standards and safety requirements in accordance with the following manufacturer's operating instructions.



Caution, risk of electrical shock

When operating the transducer, certain parts of the module can carry hazardous voltage (eg. primary busbar, power supply).

Ignoring this warning can lead to injury and/or cause serious damage.

This transducer is a built-in device, whose conducting parts must be inaccessible after installation.

A protective housing or additional shield could be used.

Main supply must be able to be disconnected.

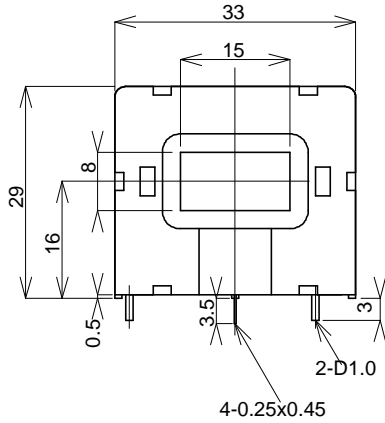
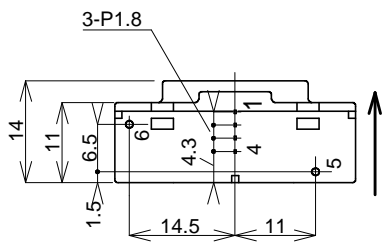
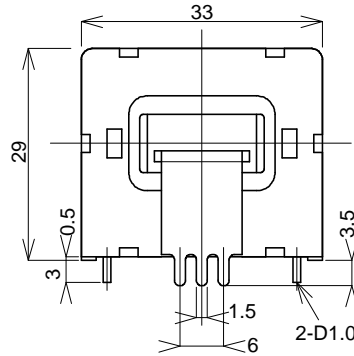
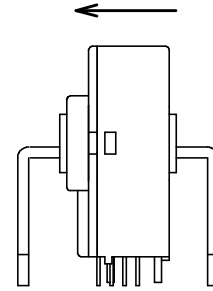
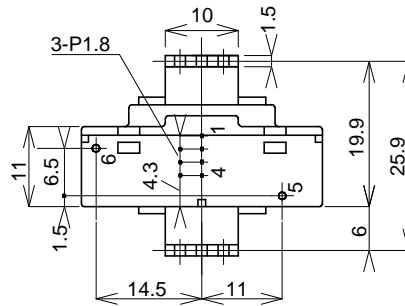
**Dimensions HAIS 50..400-P and HAIS 50..100-TP (in mm. 1 mm = 0.0394 inch)**
**HAIS 50..400-P**
**Front view**

**Bottom view**

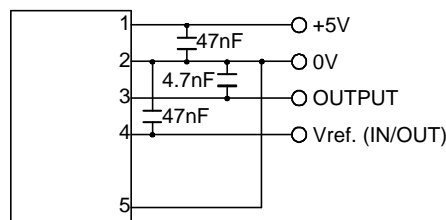
**HAIS 50..100-TP**
**Front view**

**Right view**

**Bottom view**

**Terminal Pin Identification**

- 1...+5V
- 2...0V
- 3...OUTPUT
- 4...Vref. (IN/OUT)
- 5...Core Earth (\*)
- 6...NC.

**Required Connection Circuit**

**Recommended PCB hole**

- Pin 1-4 :  $0.7 \pm 0.1$ mm
- Pin 5-6 :  $1.5 \pm 0.1$ mm
- Primary bus bar :  $2.3 \pm 0.1$ mm

General tolerance :  $\pm 0.2$ mm

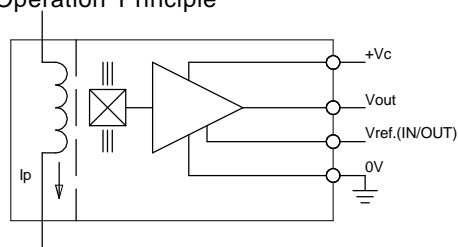
Unit : mm

**Operation Principle**

(\*) should be connected to 0V of Power Supply for better dv/dt immunity.  
 Arrow indicates positive current direction.