



Pro M Miniature circuit breakers General information

General information

Miniature circuit breakers (MCBs) are used throughout the world in all types of electrical installations. ABB MCBs are recognized for use by Underwriters Laboratories Standard UL1077 for supplementary circuit protectors in systems rated 240VAC, 480VAC and 600VAC. Devices are certified per CSA C22.2.

MCBs are approved per IEC-898 and VDE 0641, and certified under IEC-947 and VDE 0660 standards for use in systems rated 415VAC or 690VAC (S500 series).

MCBs can be applied to 16 2/3Hz – 400Hz and DC power systems.

Special direct current version MCBs include a permanent magnet for DC fault current interruption. These "UC" versions are rated 250/500VDC under UL1077/CSA 22.2 No. 235.

Continuous current ratings are as low as 0.2 amperes and up to 125 amperes maximum.

MCBs are of compact size and can be quickly mounted on standard 35mm DIN rail or can be front mounted by use of a front mounting kit.

MCBs include line and load side terminals for conductors from 18 through 4AWG (0.75 – 25mm²) for 40 amperes; up to 2AWG for 50 and 63 amperes.

MCBs can also be connected via busbar conductors which can be either upper or lower mounted for top feed or bottom feed. Dual function terminals allow busbars to be connected with main incoming line conductors without separate lugs.

Accessories

Auxiliary devices can be added to S260, S270 and S280 series MCBs:

- Shunt trips
- Auxiliary contacts
- Trip contacts
- Aux/trip contacts
- Undervoltage release

Accessory device modules can be field mounted to all above listed ABB MCBs.

Auxiliary contacts are also available for the S500 series MCB.

Applications

MCBs can be used for equipment protection, in commercial appliances, protection of control circuits against overcurrent faults, computer equipment and other computer peripheral devices.

UL 1077

MCBs are recognized as supplementary protectors and are intended for use as overcurrent protection within an appliance or other electrical equipment where branch circuit overcurrent protection is already provided or not required. MCBs and accessories are recognized under UL File E76126.

CSA C22.2

MCBs and accessories are certified under CSA C22.2 No. 235 per File LR98793.

Tripping characteristics

Time-current curves

ABB miniature circuit breakers are available with different trip characteristics, allowing for maximum system protection.

B Characteristic

Available with the S260 series has rated currents of 6 through 63 amperes in 10 steps. The "B" time-current curve is designed primarily for use in cable protection applications. Instantaneous tripping occurs between approximately 3 to 5 times rated current in 50/60Hz systems. This quick trip curve maximizes protection of control circuits under low short circuit fault levels that could damage control wiring.

C Characteristic

Available in the S260 series with rated currents up through 63 amperes and the S290 series with rated currents of 80, 100 and 125 amperes. The "C" time-current curve is designed for medium magnetic start-up currents. Instantaneous tripping occurs between 5 and 10 times rated current in 50/60 Hz systems. The "C" characteristic is also available in other S2 Series MCBs.

D Characteristic

The new magnetic trip action has an instantaneous trip point of approximately 15 times the breaker rating. Thus, the S260-D can be a good protective solution for applications involving high in-rush transformers, motors and other high inductive systems. The 260-D is also suitable for any application where a high instantaneous trip point is desired.

K Characteristic

The "K" time-current characteristic considers high magnetic start-up currents from motors, transformers and other equipment. Instantaneous tripping occurs between 8 and 12 times rated current in 50/60Hz systems. The "K" characteristic is available up through 63 amperes.

The "K" curve offers the best protection for the broadest range of electrical systems. The higher magnetic trip settings maximizes protection while allowing for higher in-rush currents during system start-up.



Pro M

Z Characteristic

Also available up through 63 amperes, the "Z" characteristic offers instantaneous tripping between 2 and 3 times rated current in 50/60Hz systems. This trip characteristic is available in the S280 series with both the 480VAC and 250/500VDC ratings.

Many applications require a very low short circuit trip settings in order to protect semiconductor or other sensitive devices and the "Z" trip characteristic may provide maximum protection and service in these applications.



General information

Interruption ratings

Trip characteristics overview

Interruption ratings

Voltage	Rated interrupting capacity	Rated current	MCB type	Comment
120 VAC	10kA	0.5 - 63A 0.5 - 63A 0.2 - 40A	S260-B,C,D S270-K S280-K, Z	Single pole Single pole Single pole
	18kA	32 - 63A 26 - 45A	S500-B,C,D S500-K	
	30kA	6 - 25A 0.15 - 25A	S500-B,C,D S500-K	
240 VAC	6kA	0.5 - 63A 0.5 - 63A 50 - 63A	S260-B,C,D S270-K S280-K, Z	Single pole Single pole Single pole
	10kA	0.5 - 63A 0.5 - 63A 0.2 - 40A	S260-B,C,D S270-K S280-K,Z	Multi pole Multi pole Single pole
	18kA	32 - 63A 26 - 45A	S500-B,C,D S500-K	
	30kA	6 - 25A 0.15 - 25A	S500-B,C,D S500-K	
277 VAC	6kA	0.5 - 63A 0.5 - 63A 50 - 63A	S260-B,C,D S270-K S280-K,Z	Single pole Single pole Single pole
	10kA	0.2 - 40A	S280-K,Z	Single pole
277/480 VAC	6kA	0.5 - 63A 0.5 - 63A 40 - 63A	S260-B,C,D S270-K S280-K,Z	Multi pole Multi pole Multi pole
	10kA	0.2 - 32A	S280-K,Z	Multi pole
60 VDC	10kA	0.5 - 63A 0.5 - 63A	S260-B,C,D S270-K	Single pole Single pole
125 VDC	10kA	0.5 - 63A 0.5 - 63A 0.2 - 63A	S260-B,C,D S270-K S280UC-K,Z	Multi pole Multi pole Single pole
250 VDC	4.5kA	0.2 - 63A	S280UC-K,Z	Single pole
500 VDC	4.5kA	0.2 - 63A	S280UC-K,Z	Multi pole

Trip characteristics overview

Curve	Magnetic characteristic ①	Thermal characteristic	Series
B	3 - 5X	1.25X	S260, S500
C	5 - 10X	1.25X	S260, S290, S500
D	10 - 20X	1.25X	S260, S500
K	8 - 12X	1.05X	S270, S280, S500
Z	2 - 3X	1.05X	S280

① All values are relative to MCB's ampere rating.

www.DataSheet4U.com

Pro M

General information

Tripping curves

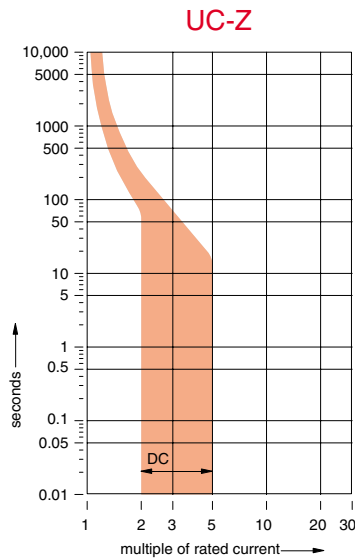
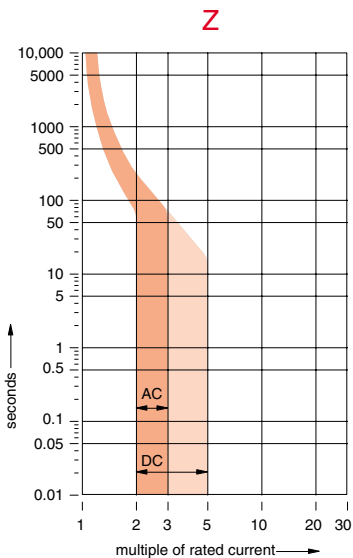
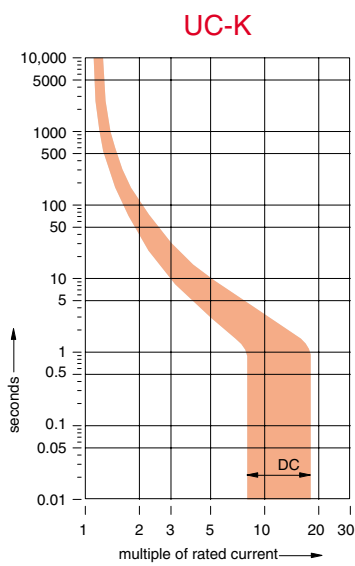
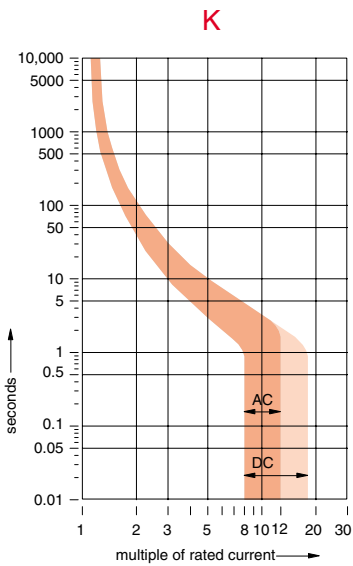
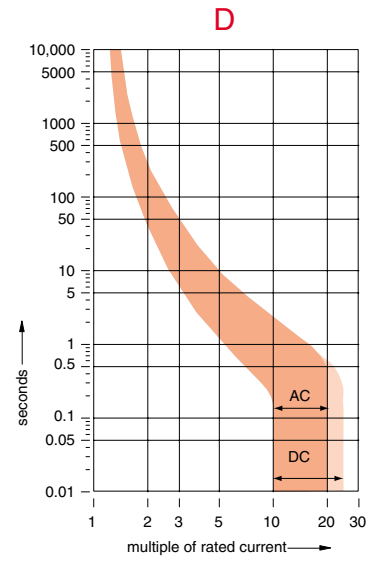
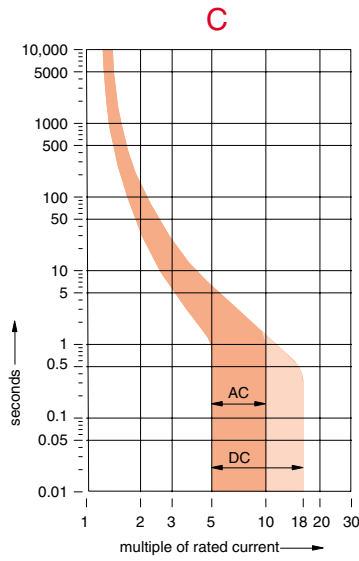
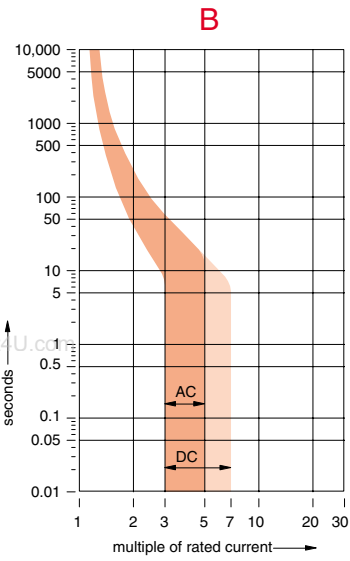

Pro M



Gen.
info.

General information

Construction details (S280 shown)

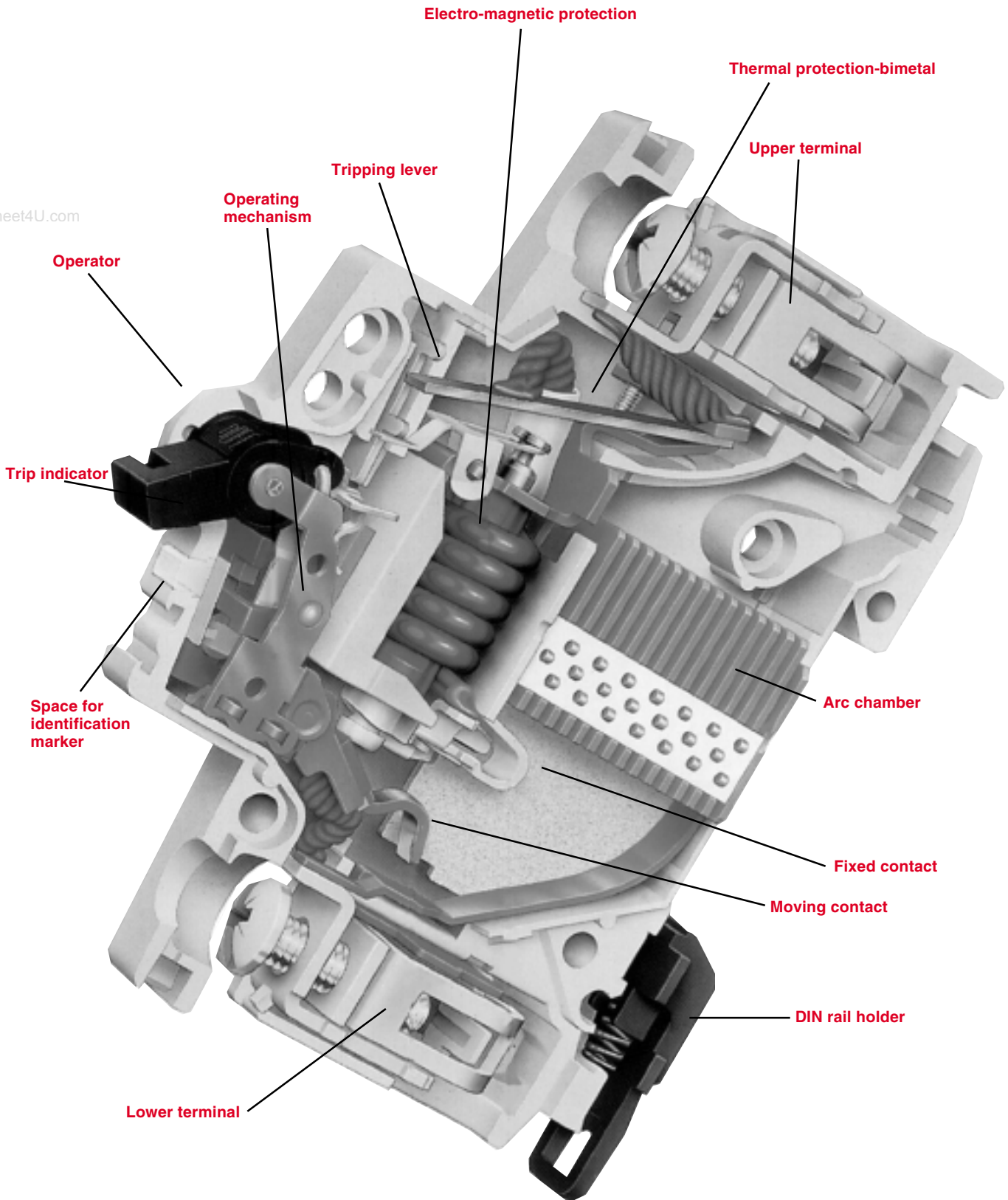



Pro M Miniature Circuit Breakers S260, S270, S280, S290

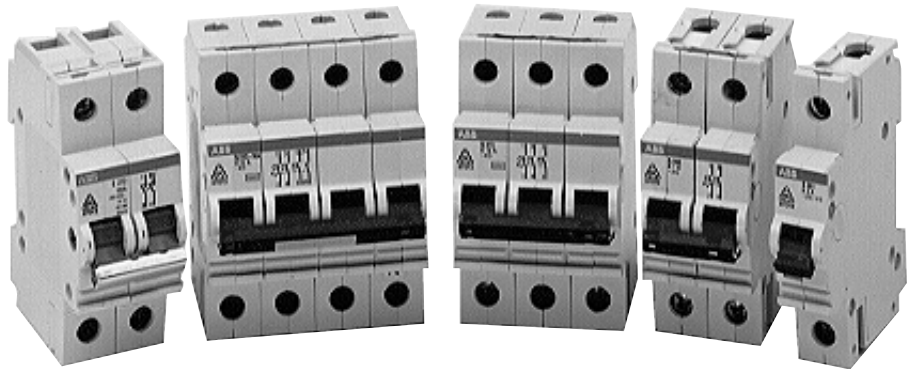

www.DataSheet4U.com

Pro M

Description

The S2 Series of miniature circuit breakers offer a compact solution to protection requirements. The breakers are recognized under standard UL 1077 as supplemental protective devices. The S2 devices are current limiting, DIN rail mounted and can offer a good equivalent to fused systems.

The S2 is available with application-specific trip characteristics to provide maximum circuit protection. The breakers offer thermal-magnetic trip protection according to B, C, D, K and Z characteristics.

For the worldwide market, the breakers carry UL, CSA, IEC, CE and many other agency approvals and certifications.

Features

- Current limiting
- Fast breaking time (2.5 – 3.5 msec)
- Unique bus connection system
- Wide range of accessories
- Available with variable depth handle mechanism
- Optional Z curve for SCR protection
- CE certified and marked
- DIN rail or front plated mounting
- Finger safe terminals
- Multi-function terminals
- Suitable for reverse feed
- UL 1077 and CSA 22.2
- 277/480VAC and 500VDC versions

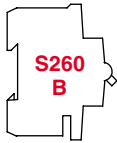

S260 277/480 VAC

B UL 1077 CSA C22.2 No. 235
VDE 0641 IEC-898
Cable protection

Pro M



S261-B6



S262-B6
S261-B6NA



S263-B6



S264-B6
S263-B6NA

B



The graph shows the tripping time in seconds on a logarithmic y-axis (0.01 to 10,000) versus the multiple of rated current on a logarithmic x-axis (1 to 30). Two curves are shown: AC (top) and DC (bottom). The AC curve starts at 10,000 seconds at 1x current and drops to approximately 10 seconds at 7x current. The DC curve starts at 10,000 seconds at 1x current and drops to approximately 10 seconds at 5x current.

Rated current	Catalog number	List price	Delivery class	Sugg. order qty	Wgt. oz. (1 pc.)
6	S261-B6	\$ 36			
10	S261-B10	36			
13	S261-B13	36			
16	S261-B16	36			
20	S261-B20	38			
25	S261-B25	38	A	10	4.5
32	S261-B32	40			
40	S261-B40	42			
50	S261-B50	48			
63	S261-B63	56			
<hr/>					
6	S261-B6NA	62			
10	S261-B10NA	62			
13	S261-B13NA	62			
16	S261-B16NA	62			
20	S261-B20NA	68	A	5	9.0
25	S261-B25NA	72			
32	S261-B32NA	74			
40	S261-B40NA	76			
50	S261-B50NA	90			
63	S261-B63NA	102			
<hr/>					
6	S262-B6	78			
10	S262-B10	78			
13	S262-B13	78			
16	S262-B16	78			
20	S262-B20	86	A	5	9.0
25	S262-B25	88			
32	S262-B32	94			
40	S262-B40	98			
50	S262-B50	112			
63	S262-B63	128			

Rated current	Catalog number	List price	Delivery class	Sugg. order qty	Wgt. oz. (1 pc.)
6	S263-B6	\$ 118			
10	S263-B10	118			
13	S263-B13	118			
16	S263-B16	118			
20	S263-B20	130	A	3	13.5
25	S263-B25	132			
32	S263-B32	142			
40	S263-B40	148			
50	S263-B50	170			
63	S263-B63	194			
<hr/>					
6	S263-B6NA	142			
10	S263-B10NA	142			
13	S263-B13NA	142			
16	S263-B16NA	142			
20	S263-B20NA	162	A	2	18.0
25	S263-B25NA	168			
32	S263-B32NA	176			
40	S263-B40NA	184			
50	S263-B50NA	212			
63	S263-B63NA	240			
<hr/>					
6	S264-B6	156			
10	S264-B10	156			
13	S264-B13	156			
16	S264-B16	156			
20	S264-B20	172	B	2	18.0
25	S264-B25	176			
32	S264-B32	188			
40	S264-B40	196			
50	S264-B50	224			
63	S264-B63	256			

Switched neutral

To create a miniature circuit breaker from stock items with a switched neutral, order standard MCB (usually a single or three pole version) and a neutral disconnect module, S2-NT, which can be field added to the MCB.

Delivery Class

- A** - Standard item, stock to 2 weeks lead time
- B** - Stock to 4 weeks lead time
- C** - 6 to 8 week lead time
- D** - 10 to 12 week lead time
- E** - Call for delivery

S260

277/480 VAC

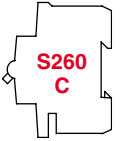

C UL 1077 CSA C22.2 - NO. 235
VDE 0641 IEC-898
Cable & equipment protection



Rated current	Catalog number	List price	Delivery class	Sugg. order qty	Wgt. oz. (1 pc.)
0.5	S261-C0.5	\$ 42			
1	S261-C1	42			
1.6	S261-C1.6	42			
2	S261-C2	42			
3	S261-C3	42			
4	S261-C4	42			
6	S261-C6	42			
8	S261-C8	42			
10	S261-C10	42	A	10	4.5
13	S261-C13	42			
16	S261-C16	42			
20	S261-C20	42			
25	S261-C25	46			
32	S261-C32	48			
40	S261-C40	52			
50	S261-C50	60			
63	S261-C63	68			
0.5	S261-C0.5NA	84			
1	S261-C1NA	84			
1.6	S261-C1.6NA	84			
2	S261-C2NA	84			
3	S261-C3NA	84			
4	S261-C4NA	84			
6	S261-C6NA	84			
8	S261-C8NA	84	B	5	9.0
10	S261-C10NA	84			
13	S261-C13NA	84			
16	S261-C16NA	84			
20	S261-C20NA	84			
25	S261-C25NA	88			
32	S261-C32NA	90			
40	S261-C40NA	96			
50	S261-C50NA	112			
63	S261-C63NA	130			
0.5	S262-C0.5	96			
1	S262-C1	96			
1.6	S262-C1.6	96			
2	S262-C2	96			
3	S262-C3	96			
4	S262-C4	96			
6	S262-C6	96			
8	S262-C8	96			
10	S262-C10	96	A	5	9.0
13	S262-C13	96			
16	S262-C16	96			
20	S262-C20	96			
25	S262-C25	106			
32	S262-C32	106			
40	S262-C40	116			
50	S262-C50	136			
63	S262-C63	152			

Rated current	Catalog number	List price	Delivery class	Sugg. order qty	Wgt. oz. (1 pc.)
0.5	S263-C0.5	\$ 138			
1	S263-C1	138			
1.6	S263-C1.6	138			
2	S263-C2	138			
3	S263-C3	138			
4	S263-C4	138			
6	S263-C6	138			
8	S263-C8	138			
10	S263-C10	138	A	3	13.5
13	S263-C13	138			
16	S263-C16	138			
20	S263-C20	138			
25	S263-C25	156			
32	S263-C32	158			
40	S263-C40	174			
50	S263-C50	200			
60	S263-CS60	228			
63	S263-C63	228			
0.5	S263-C0.5NA	200			
1	S263-C1NA	200			
1.6	S263-C1.6NA	200			
2	S263-C2NA	200			
3	S263-C3NA	200			
4	S263-C4NA	200			
6	S263-C6NA	200			
8	S263-C8NA	200	B	2	18.0
10	S263-C10NA	200			
13	S263-C13NA	200			
16	S263-C16NA	200			
20	S263-C20NA	200			
25	S263-C25NA	206			
32	S263-C32NA	212			
40	S263-C40NA	224			
50	S263-C50NA	264			
63	S263-C63NA	304			
0.5	S264-C0.5	218			
1	S264-C1	218			
1.6	S264-C1.6	218			
2	S264-C2	218			
3	S264-C3	218			
4	S264-C4	218			
6	S264-C6	218			
8	S264-C8	218	B	2	18.0
10	S264-C10	218			
13	S264-C13	218			
16	S264-C16	218			
20	S264-C20	218			
25	S264-C25	234			
32	S264-C32	238			
40	S264-C40	260			
50	S264-C50	300			
63	S264-C63	338			

Switched neutral

To create a miniature circuit breaker from stock items with a switched neutral, order standard MCB (usually a single or three pole version) and a neutral disconnect module, S2-NT, which can be field added to the MCB.

Delivery Class

- A** - Standard item, stock to 2 weeks lead time
- B** - Stock to 4 weeks lead time
- C** - 6 to 8 week lead time
- D** - 10 to 12 week lead time
- E** - Call for delivery

Pro M

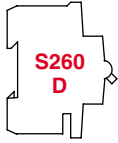

S260 277/480 VAC

D UL 1077 CSA C22.2
VDE 0641 IEC-898
Cable & equipment protection



Rated current	Catalog number	List price	Delivery class	Sugg. order qty	Wgt. oz. (1 pc.)
0.5	S261-D0.5	\$ 42			
1	S261-D1	42			
1.6	S261-D1.6	42			
2	S261-D2	42			
3	S261-D3	42			
4	S261-D4	42			
6	S261-D6	42			
8	S261-D8	42			
10	S261-D10	42	A	10	4.5
13	S261-D13	42			
16	S261-D16	42			
20	S261-D20	42			
25	S261-D25	46			
32	S261-D32	48			
40	S261-D40	52			
50	S261-D50	60			
63	S261-D63	68			

0.5	S262-D0.5	96			
1	S262-D1	96			
1.6	S262-D1.6	96			
2	S262-D2	96			
3	S262-D3	96			
4	S262-D4	96			
6	S262-D6	96			
8	S262-D8	96			
10	S262-D10	96	A	5	9.0
13	S262-D13	96			
16	S262-D16	96			
20	S262-D20	96			
25	S262-D25	106			
32	S262-D32	106			
40	S262-D40	116			
50	S262-D50	136			
63	S262-D63	152			

Rated current	Catalog number	List price	Delivery class	Sugg. order qty	Wgt. oz. (1 pc.)
0.5	S263-D0.5	\$ 138			
1	S263-D1	138			
1.6	S263-D1.6	138			
2	S263-D2	138			
3	S263-D3	138			
4	S263-D4	138			
6	S263-D6	138			
8	S263-D8	138	A	3	13.5
10	S263-D10	138			
13	S263-D13	138			
16	S263-D16	138			
20	S263-D20	138			
25	S263-D25	156			
32	S263-D32	158			
40	S263-D40	174			
50	S263-D50	200			
63	S263-D63	228			

Delivery Class

- A - Standard item, stock to 2 weeks lead time
- B - Stock to 4 weeks lead time
- C - 6 to 8 week lead time
- D - 10 to 12 week lead time
- E - Call for delivery

Switched neutral

To create a miniature circuit breaker from stock items with a switched neutral, order standard MCB (usually a single or three pole version) and a neutral disconnect module, S2-NT, which can be field added to the MCB.

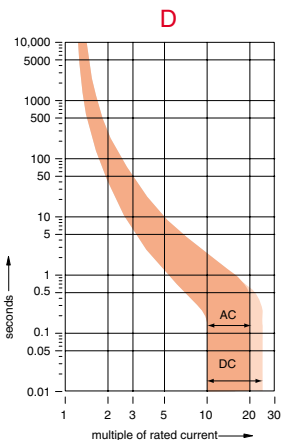

S270

277/480 VAC

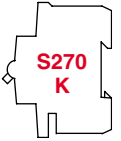

K UL 1077 CSA C22.2 - NO. 235
 VDE 0641 IEC-898
 Cable & equipment protection

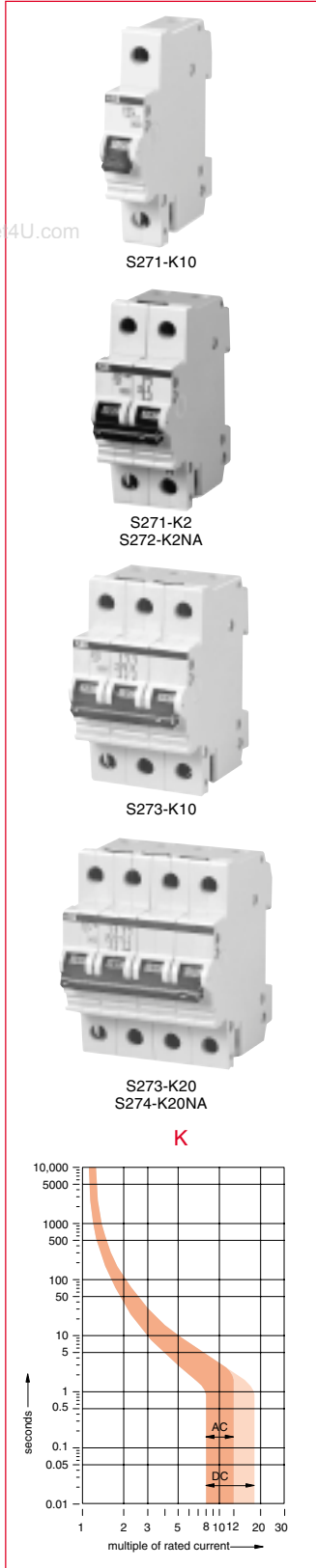

Rated current	Catalog number	List price	Delivery class	Sugg. order qty	Wgt. oz. (1 pc.)
0.5	S271-K0.5	\$ 42			
1	S271-K1	42			
1.6	S271-K1.6	42			
2	S271-K2	42			
3	S271-K3	42			
4	S271-K4	42			
5	S271-KS5	42			
6	S271-K6	42			
8	S271-K8	42			
10	S271-K10	42			
13	S271-K13	42	A	10	4.5
15	S271-KS15	42			
16	S271-K16	42			
20	S271-K20	42			
25	S271-K25	46			
30	S271-KS30	48			
32	S271-K32	48			
40	S271-K40	52			
50	S271-K50	60			
60	S271-KS60	68			
63	S271-K63	68			
0.5	S271-K0.5NA	84			
1	S271-K1NA	84			
1.6	S271-K1.6NA	84			
2	S271-K2NA	84			
3	S271-K3NA	84			
4	S271-K4NA	84			
6	S271-K6NA	84			
8	S271-K8NA	84			
10	S271-K10NA	84	B	5	9.0
13	S271-K13NA	84			
16	S271-K16NA	84			
20	S271-K20NA	84			
25	S271-K25NA	88			
32	S271-K32NA	90			
40	S271-K40NA	96			
50	S271-K50NA	112			
63	S271-K63NA	130			
0.5	S272-K0.5	96			
1	S272-K1	96			
1.6	S272-K1.6	96			
2	S272-K2	96			
3	S272-K3	96			
4	S272-K4	96			
5	S272-KS5	96			
6	S272-K6	96			
8	S272-K8	96			
10	S272-K10	96	A	5	9.0
13	S272-K13	96			
15	S272-KS15	96			
16	S272-K16	96			
20	S272-K20	96			
25	S272-K25	106			
30	S272-KS30	106			
32	S272-K32	106			
40	S272-K40	116			
50	S272-K50	136			
60	S272-KS60	152			
63	S272-K63	152			

Rated current	Catalog number	List price	Delivery class	Sugg. order qty	Wgt. oz. (1 pc.)
0.5	S273-K0.5	\$ 138			
1	S273-K1	138			
1.6	S273-K1.6	138			
2	S273-K2	138			
3	S273-K3	138			
4	S273-K4	138			
5	S273-KS5	138			
6	S273-K6	138			
8	S273-K8	138			
10	S273-K10	138			
13	S273-K13	138	A	3	13.5
15	S273-KS15	138			
16	S273-K16	138			
20	S273-K20	138			
25	S273-K25	156			
30	S273-KS30	158			
32	S273-K32	158			
40	S273-K40	174			
50	S273-K50	200			
60	S273-KS60	228			
63	S273-K63	228			
0.5	S273-K0.5NA	200			
1	S273-K1NA	200			
1.6	S273-K1.6NA	200			
2	S273-K2NA	200			
3	S273-K3NA	200			
4	S273-K4NA	200			
6	S273-K6NA	200			
8	S273-K8NA	200			
10	S273-K10NA	200	B	2	18.0
13	S273-K13NA	200			
16	S273-K16NA	200			
20	S273-K20NA	200			
25	S273-K25NA	206			
32	S273-K32NA	212			
40	S273-K40NA	224			
50	S273-K50NA	264			
63	S273-K63NA	304			
0.5	S274-K0.5	218			
1	S274-K1	218			
1.6	S274-K1.6	218			
2	S274-K2	218			
3	S274-K3	218			
4	S274-K4	218			
6	S274-K6	218			
8	S274-K8	218	B	2	18.0
10	S274-K10	218			
13	S274-K13	218			
16	S274-K16	218			
20	S274-K20	218			
25	S274-K25	234			
32	S274-K32	238			
40	S274-K40	260			
50	S274-K50	300			
63	S274-K63	338			

Switched neutral

To create a miniature circuit breaker from stock items with a switched neutral, order standard MCB (usually a single or three pole version) and a neutral disconnect module, S2-NT, which can be field added to the MCB.

Delivery Class

- A** - Standard item, stock to 2 weeks lead time
- B** - Stock to 4 weeks lead time
- C** - 6 to 8 week lead time
- D** - 10 to 12 week lead time
- E** - Call for delivery

Pro M



S280 277/480 VAC

K UL 1077 CSA C22.2 - NO. 235
VDE 0660
Cable & equipment protection

S281-K16

S282-K1

S283-K63

Pro M

Rated current	Catalog number	List price	Delivery class	Sugg. order qty	Wgt. oz. (1 pc.)
0.2	S281-K0.2	\$ 54	A	10	4.6
0.3	S281-K0.3	54			
0.5	S281-K0.5	54			
0.75	S281-K0.75	54			
1	S281-K1	54			
1.6	S281-K1.6	54			
2	S281-K2	54			
3	S281-K3	54			
4	S281-K4	54			
6	S281-K6	54			
8	S281-K8	54			
10	S281-K10	54			
13	S281-K13	54			
16	S281-K16	54			
20	S281-K20	54			
25	S281-K25	56			
32	S281-K32	58			
40	S281-K40	64			
50	S281-K50	70			
63	S281-K63	80			
0.2	S282-K0.2	128	A	5	9.2
0.3	S282-K0.3	128			
0.5	S282-K0.5	128			
0.75	S282-K0.75	128			
1	S282-K1	128			
1.6	S282-K1.6	128			
2	S282-K2	128			
3	S282-K3	128			
4	S282-K4	128			
6	S282-K6	128			
8	S282-K8	128			
10	S282-K10	128			
13	S282-K13	128			
16	S282-K16	128			
20	S282-K20	128			
25	S282-K25	130			
32	S282-K32	134			
40	S282-K40	134			
50	S282-K50	162			
63	S282-K63	182			

Rated current	Catalog number	List price	Delivery class	Sugg. order qty	Wgt. oz. (1 pc.)
0.2	S283-K0.2	\$ 194	A	3	13.9
0.3	S283-K0.3	194			
0.5	S283-K0.5	194			
0.75	S283-K0.75	194			
1	S283-K1	194			
1.6	S283-K1.6	194			
2	S283-K2	194			
3	S283-K3	194			
4	S283-K4	194			
6	S283-K6	194			
8	S283-K8	194			
10	S283-K10	194			
13	S283-K13	194			
16	S283-K16	194			
20	S283-K20	194			
25	S283-K25	196			
32	S283-K32	200			
40	S283-K40	214			
50	S283-K50	246			
63	S283-K63	280			

Delivery Class

- A - Standard item, stock to 2 weeks lead time
- B - Stock to 4 weeks lead time
- C - 6 to 8 week lead time
- D - 10 to 12 week lead time
- E - Call for delivery

Switched neutral

To create a miniature circuit breaker from stock items with a switched neutral, order standard MCB (usually a single or three pole version) and a neutral disconnect module, S2-NT, which can be field added to the MCB.

S280 (W)

for use with ring tongue terminal connectors
277/480 VAC

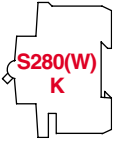

K UL 1077 CSA C22.2 - NO. 235
VDE 0660
Cable & equipment protection



Rated current	Catalog number	List price	Delivery class	Sugg. order qty	Wgt. oz. (1 pc.)
0.2	S281-K0.2W	\$ 54	A	10	4.6
0.3	S281-K0.3W	54			
0.5	S281-K0.5W	54			
0.75	S281-K0.75W	54			
1	S281-K1W	54			
1.6	S281-K1.6W	54			
2	S281-K2W	54			
3	S281-K3W	54			
4	S281-K4W	54			
6	S281-K6W	54			
8	S281-K8W	54			
10	S281-K10W	54			
13	S281-K13W	54			
16	S281-K16W	54			
20	S281-K20W	54			
25	S281-K25W	56			
32	S281-K32W	58			
40	S281-K40W	64			
50	S281-K50W	70			
63	S281-K63W	80			
0.2	S282-K0.2W	128	A	5	9.2
0.3	S282-K0.3W	128			
0.5	S282-K0.5W	128			
0.75	S282-K0.75W	128			
1	S282-K1W	128			
1.6	S282-K1.6W	128			
2	S282-K2W	128			
3	S282-K3W	128			
4	S282-K4W	128			
6	S282-K6W	128			
8	S282-K8W	128			
10	S282-K10W	128			
13	S282-K13W	128			
16	S282-K16W	128			
20	S282-K20W	128			
25	S282-K25W	130			
32	S282-K32W	134			
40	S282-K40W	134			
50	S282-K50W	162			
63	S282-K63W	182			

Rated current	Catalog number	List price	Delivery class	Sugg. order qty	Wgt. oz. (1 pc.)
0.2	S283-K0.2W	\$ 194	A	3	13.9
0.3	S283-K0.3W	194			
0.5	S283-K0.5W	194			
0.75	S283-K0.75W	194			
1	S283-K1W	194			
1.6	S283-K1.6W	194			
2	S283-K2W	194			
3	S283-K3W	194			
4	S283-K4W	194			
6	S283-K6W	194			
8	S283-K8W	194			
10	S283-K10W	194			
13	S283-K13W	194			
16	S283-K16W	194			
20	S283-K20W	194			
25	S283-K25W	196			
32	S283-K32W	200			
40	S283-K40W	214			
50	S283-K50W	246			
63	S283-K63W	280			

Delivery Class

A - Standard item, stock to 2 weeks lead time
B - Stock to 4 weeks lead time
C - 6 to 8 week lead time
D - 10 to 12 week lead time
E - Call for delivery

Screws (must be ordered separately!)

Item	Catalog number	List price ②
PKG of 20 screws	S2-SCR	No charge

① For use with ring tongue or cable terminals only. Cannot be used with busbar system.
 ② No charge when ordered with the S280(W).

Pro M

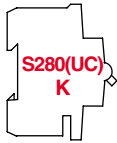

S280UC 500 VDC

K UL 1077 VDE 0660
CSA 22.2 No. 235
Cable and Equipment Protection



S281UC-K25



S282UC-K8



S283UC-K16

UC-K

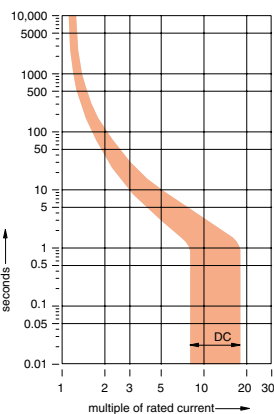

Rated current	Catalog number	List price	Delivery class	Sugg. order qty	Wgt. oz. (1 pc.)	Rated current	Catalog number	List price	Delivery class	Sugg. order qty	Wgt. oz. (1 pc.)
0.2	S281UC-K0.2	\$ 104				0.2	S283UC-K0.2	\$ 370			
0.3	S281UC-K0.3	104				0.3	S283UC-K0.3	370			
0.5	S281UC-K0.5	104				0.5	S283UC-K0.5	370			
0.75	S281UC-K0.75	104				0.75	S283UC-K0.75	370			
1	S281UC-K1	104				1	S283UC-K1	370			
1.6	S281UC-K1.6	104				1.6	S283UC-K1.6	370			
2	S281UC-K2	104				2	S283UC-K2	370			
3	S281UC-K3	104				3	S283UC-K3	370			
4	S281UC-K4	104				4	S283UC-K4	370			
6	S281UC-K6	104	B	10	4.6	6	S283UC-K6	370	B	3	13.9
8	S281UC-K8	104				8	S283UC-K8	370			
10	S281UC-K10	104				10	S283UC-K10	370			
16	S281UC-K16	104				16	S283UC-K16	370			
20	S281UC-K20	104				20	S283UC-K20	370			
25	S281UC-K25	108				25	S283UC-K25	382			
32	S281UC-K32	110				32	S283UC-K32	408			
40	S281UC-K40	116				40	S283UC-K40	448			
50	S281UC-K50	136				50	S283UC-K50	472			
63	S281UC-K63	152				63	S283UC-K63	534			
0.2	S282UC-K0.2	242									
0.3	S282UC-K0.3	242									
0.5	S282UC-K0.5	242									
0.75	S282UC-K0.75	242									
1	S282UC-K1	242									
1.6	S282UC-K1.6	242									
2	S282UC-K2	242									
3	S282UC-K3	242									
4	S282UC-K4	242	B	5	9.2						
6	S282UC-K6	242									
8	S282UC-K8	242									
10	S282UC-K10	242									
16	S282UC-K16	242									
20	S282UC-K20	242									
25	S282UC-K25	248									
32	S282UC-K32	256									
40	S282UC-K40	266									
50	S282UC-K50	312									
63	S282UC-K63	348									

Delivery Class

- A - Standard item, stock to 2 weeks lead time
- B - Stock to 4 weeks lead time
- C - 6 to 8 week lead time
- D - 10 to 12 week lead time
- E - Call for delivery

Direct current applications

The S280UC differs from standard miniature circuit breakers in that the UC versions include a permanent magnet which aids in the extinguishing of the arc during medium and high level faults. It is necessary to observe the correct polarity and current direction when connecting the UC breakers. Two examples of correct connection are shown below.

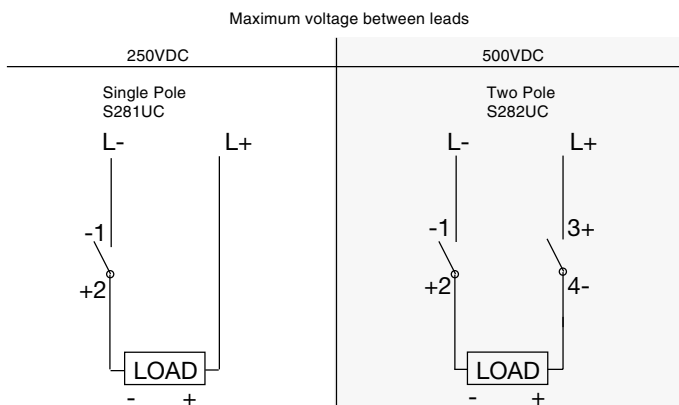

Termination points are marked on all UC type MCBs, points one (1) and four (4) are negative and points two (2) and three (3) are positive. Four pole breakers are also available for voltage reversal applications.

S280 & S280UC 277/480VAC & 500VDC

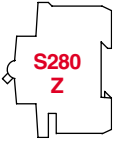

Z

UL 1077 VDE 0660
CSA 22.2 No. 235
Fast trip characteristic



480 VAC Class

Rated current	Catalog number	List price	Delivery class	Sugg. order qty	Wgt. oz. (1 pc.)
0.5	S281-Z0.5	\$ 70			
1	S281-Z1	70			
1.6	S281-Z1.6	70			
2	S281-Z2	70			
3	S281-Z3	70			
4	S281-Z4	70			
6	S281-Z6	70			
8	S281-Z8	70	B	10	4.5
10	S281-Z10	70			
16	S281-Z16	70			
20	S281-Z20	70			
25	S281-Z25	70			
32	S281-Z32	74			
40	S281-Z40	78			
50	S281-Z50	88			
63	S281-Z63	100			
0.5	S282-Z0.5	162			
1	S282-Z1	162			
1.6	S282-Z1.6	162			
2	S282-Z2	162			
3	S282-Z3	162			
4	S282-Z4	162			
6	S282-Z6	162			
8	S282-Z8	162	B	5	9.2
10	S282-Z10	162			
16	S282-Z16	162			
20	S282-Z20	162			
25	S282-Z25	184			
32	S282-Z32	170			
40	S282-Z40	176			
50	S282-Z50	206			
63	S282-Z63	232			
0.5	S283-Z0.5	244			
1	S283-Z1	244			
1.6	S283-Z1.6	244			
2	S283-Z2	244			
3	S283-Z3	244			
4	S283-Z4	244			
6	S283-Z6	244			
8	S283-Z8	244	B	3	13.9
10	S283-Z10	244			
16	S283-Z16	244			
20	S283-Z20	244			
25	S283-Z25	248			
32	S283-Z32	254			
40	S283-Z40	266			
50	S283-Z50	306			
63	S283-Z63	344			

500 VDC Class

Rated current	Catalog number	List price	Delivery class	Sugg. order qty	Wgt. oz. (1 pc.)
0.5	S281UC-Z0.5	\$ 168			
1	S281UC-Z1	168			
1.6	S281UC-Z1.6	168			
2	S281UC-Z2	168			
3	S281UC-Z3	168			
4	S281UC-Z4	168			
6	S281UC-Z6	168			
8	S281UC-Z8	168			
10	S281UC-Z10	168	B	10	4.6
16	S281UC-Z16	168			
20	S281UC-Z20	168			
25	S281UC-Z25	170			
32	S281UC-Z32	176			
40	S281UC-Z40	188			
50	S281UC-Z50	216			
63	S281UC-Z63	242			
0.5	S282UC-Z0.5	390			
1	S282UC-Z1	390			
1.6	S282UC-Z1.6	390			
2	S282UC-Z2	390			
3	S282UC-Z3	390			
4	S282UC-Z4	390			
6	S282UC-Z6	390			
8	S282UC-Z8	390	B	5	9.2
10	S282UC-Z10	390			
16	S282UC-Z16	390			
20	S282UC-Z20	390			
25	S282UC-Z25	398			
32	S282UC-Z32	410			
40	S282UC-Z40	426			
50	S282UC-Z50	498			
63	S282UC-Z63	558			
0.5	S283UC-Z0.5	594			
1	S283UC-Z1	594			
1.6	S283UC-Z1.6	594			
2	S283UC-Z2	594			
3	S283UC-Z3	594			
4	S283UC-Z4	594			
6	S283UC-Z6	594			
8	S283UC-Z8	594	B	3	13.9
10	S283UC-Z10	594			
16	S283UC-Z16	594			
20	S283UC-Z20	594			
25	S283UC-Z25	603			
32	S283UC-Z32	612			
40	S283UC-Z40	657			
50	S283UC-Z50	756			
63	S283UC-Z63	855			

Pro M

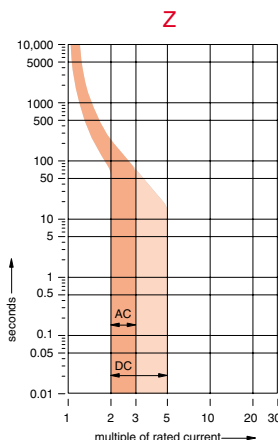
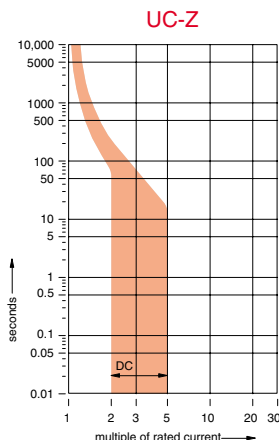

Switched neutral

To create a miniature circuit breaker from stock items with a switched neutral, order standard MCB (usually a single or three pole version) and a neutral disconnect module, S2-NT, which can be field added to the MCB. See accessories page 1.18.

Direct current applications

Please refer to the chart on page 1.12..

Delivery Class

- A - Standard item, stock to 2 weeks lead time
- B - Stock to 4 weeks lead time
- C - 6 to 8 week lead time
- D - 10 to 12 week lead time
- E - Call for delivery

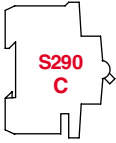

S290 277/480 VAC

C VDE 0660
Cable and equipment protection

480 VAC Class

Rated current	Catalog number	List price	Delivery class	Sugg. order qty	Wgt. oz. (1 pc.)
80	S291-C80	\$ 138			
100	S291-C100	144	B	6	9.2
125	S291-C125	192			
80	S292-C80	340			
100	S292-C100	364	B	3	18.4
125	S292-C125	568			
80	S293-C80	536			
100	S293-C100	548	B	2	27.6
125	S293-C125	732			
80	S294-C80	740			
100	S294-C100	756	B	1	36.8
125	S294-C125	948			

Auxiliary contact

S290-H11	72	B	1	1.75
----------	-----------	---	---	------

Bell alarm

S290-S	112	B	1	1.75
--------	------------	---	---	------

Shunt trip

S290-A1	144	B	1	6.2
---------	------------	---	---	-----

For field mounting, left side, 110V – 415VAC

S290-A2	144	B	1	6.2
---------	------------	---	---	-----

For field mounting, left side, 24 – 48VDC

Delivery Class

- A - Standard item, stock to 2 weeks lead time
- B - Stock to 4 weeks lead time
- C - 6 to 8 week lead time
- D - 10 to 12 week lead time
- E - Call for delivery



S291-C80

S290-H11

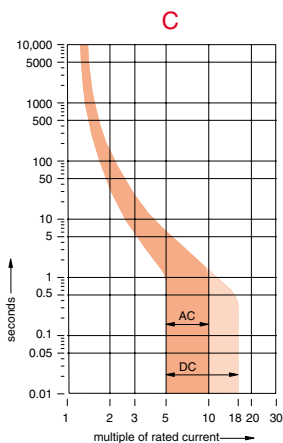

Accessories

Busbars

S260, S270, S280

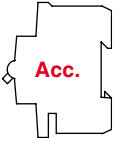

1 Phase

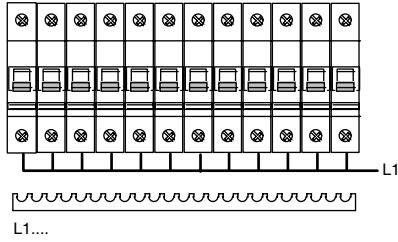

Amp rating	Number of poles	Busbar length	End cap catalog number	Catalog number	List price	Delivery class	Suggested order qty. quantity	Weight ounce (2 pc.)
55	12	207	-	SZ-KS1/12	\$ 12	A	10	0.6
55	56	988	-	SZ-KS1/56	36		5	2.6
85	56	988	-	SZ-KS2/56	46		5	5.2
110	56	988	-	SZ-VB45.32	68		5	10.0

Uninsulated copper bar mounts flush with bottom edge of circuit breakers.
For use on load side (bottom) of S260, S270, S280 and line side (top) of S280 MCBs.

2 Phase

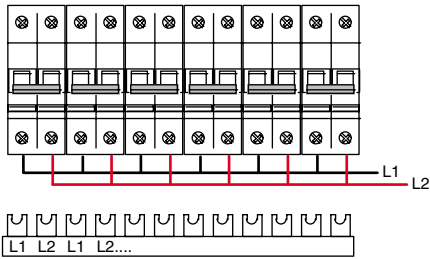

Amp rating	Number of poles	Busbar length	End cap catalog number	Catalog number	List price	Delivery class	Suggested order qty. quantity	Weight ounce (2 pc.)
50	58	1035	PSB-END3	SZ-PSB54N	\$ 122	A	1	14.4
65	58	1035	PSB-END3	SZ-PSB56N	122			19.1
50	12	213	-	PSB-53UL	40			4.0

Insulated busbar assembly contains 2 separate circuits for use with 1, 1+N or 2 pole MCBs.
For use on load side (bottom) of S260, S270, S280 and line side (top) of S280 MCBs.

3 Phase

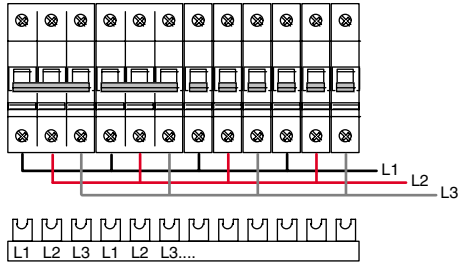

Amp rating	Number of poles	Busbar length	End cap catalog number	Catalog number	List price	Delivery class	Suggested order qty. quantity	Weight ounce (2 pc.)
50	12	213	-	PSB-3UL	\$ 60	A	3	4.3
65	60	1065	PSB-END5	SZ-PSB4N	130		1	21.4
50	60	1065	PSB-END6	SZ-PSB12N	176		1	34.2

Insulated busbar assembly contains 3 separate circuits for use with 1 or 3 pole MCBs.
For use on load side (bottom) of S260, S270, S280 and line side (top) of S280 MCBs.

4 Phase

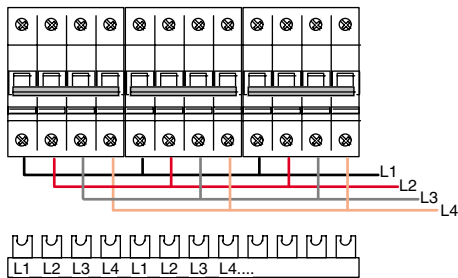

Amp rating	Number of poles	Busbar length	End cap catalog number	Catalog number	List price	Delivery class	Suggested order qty. quantity	Weight ounce (2 pc.)
50	60	1035	PSB-END4	SZ-PSB62N	\$ 204	A	1	23.2
65	60	988	PSB-END4	SZ-PSB64N	236			31.6

Insulated busbar assembly contains 4 separate circuits for use with 3+N1 or 4 pole MCBs.
For use on load side (bottom) of S260, S270, S280 and line side (top) of S280 MCBs.

Delivery Class

- A - Standard item, stock to 2 weeks lead time
- B - Stock to 4 weeks lead time
- C - 6 to 8 week lead time
- D - 10 to 12 week lead time
- E - Call for delivery

Pro M



Accessories

Busbars

S260, S270, S280

1 Phase with 1 auxiliary

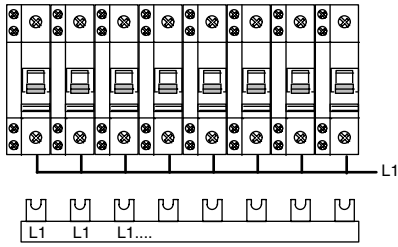

Amp rating	Number of poles	Busbar length	End cap catalog number	Catalog number	List price	Delivery class	Suggested order qty. quantity	Weight ounce (2 pc.)
50	39	1044	PSB-END3	SZ-KS3/39N	\$ 50	A	1	7.4
65	39	1044	PSB-END3	SZ-KS4/39N	56	A	1	10.1

Uninsulated copper bar mounts flush with bottom edge of circuit breakers.
For use on load side (bottom) of S260, S270, S280 and line side (top) of S280 MCBs.

3 Phase for 1 pole MCB's with 1 auxiliary

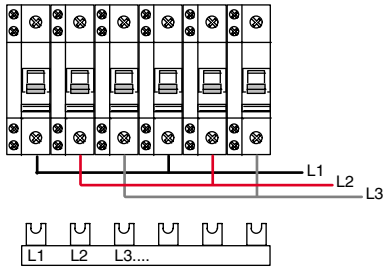

Amp rating	Number of poles	Busbar length	End cap catalog number	Catalog number	List price	Delivery class	Suggested order qty. quantity	Weight ounce (2 pc.)
50	58	1044	PSB-END3	SZ-PSB46N	\$ 124	B	1	16.1
65	58	1044	PSB-END3	SZ-PSB48N	158	B	1	22.1

Insulated busbar assembly contains 2 separate circuits for use with 1, 1+N or 2 pole MCBs.
For use on load side (bottom) of S260, S270, S280 and line side (top) of S280 MCBs.

2 Phase with 1 auxiliary

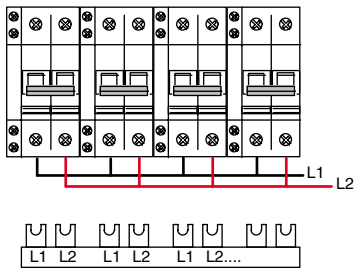

Amp rating	Number of poles	Busbar length	End cap catalog number	Catalog number	List price	Delivery class	Suggested order qty. quantity	Weight ounce (2 pc.)
65	48	1065	—	SZ-PSB92N	174	B	1	23.2

Insulated busbar assembly contains 3 separate circuits for use with 1 or 3 pole MCBs.
For use on load side (bottom) of S260, S270, S280 and line side (top) of S280 MCBs.

3 Phase with 1 auxiliary

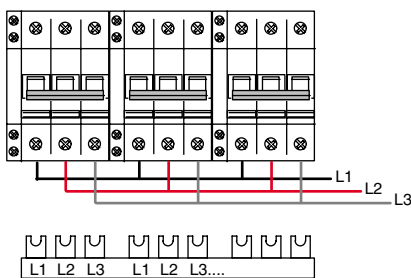

Amp rating	Number of poles	Busbar length	End cap catalog number	Catalog number	List price	Delivery class	Suggested order qty. quantity	Weight ounce (2 pc.)
50	48	980	PSB-END3	SZ-PSB50N	\$ 124	B	1	15.8
65	48	980	PSB-END3	SZ-PSB52N	158	A	1	22.6

Insulated busbar assembly contains 4 separate circuits for use with 3+N1 or 4 pole MCBs.
For use on load side (bottom) of S260, S270, S280 and line side (top) of S280 MCBs.

Delivery Class

- A - Standard item, stock to 2 weeks lead time
- B - Stock to 4 weeks lead time
- C - 6 to 8 week lead time
- D - 10 to 12 week lead time
- E - Call for delivery

Accessories

Busbars

S260, S270, S280



3 Phase

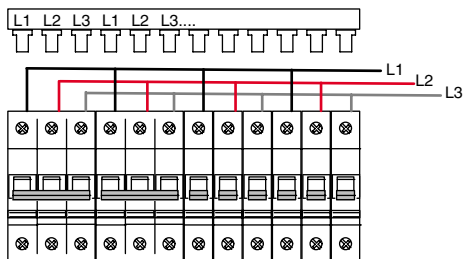

Amp rating	Number of poles	Busbar length	End cap catalog number	Catalog number	List price	Delivery class	Suggested order qty. quantity	Weight ounce (2 pc.)
50	12	213	—	SZ-PSB21	\$ 40	A	1	4.5
50	60	1065	—	SZ-PSB22	130			21.4
65	12	213	—	SZ-PSB23	50			6.0
65	60	1065	—	SZ-PSB24	176			34.2

Insulated busbar assembly contains 3 separate circuits for use with 1, 2+N or 3 pole MCBs. For use on line side (top) of S260 and S270 MCBs.

3 ph + N, for use with 2 pole MCB's on 3 ph / 4W system

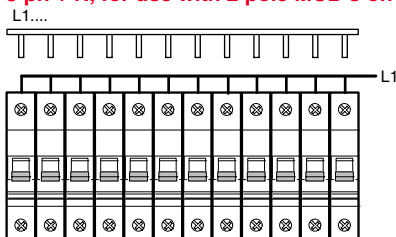

Amp rating	Number of poles	Busbar length	End cap catalog number	Catalog number	List price	Delivery class	Suggested order qty. quantity	Weight ounce (2 pc.)
50	12	202	—	SZ-KS16/12N	\$ 13	A	1	1.5
50	56	1007	—	SZ-KS16/56N	55			9.0

Insulated busbar assembly contains 1 circuit for use with 1 pole MCBs. For use on line side (top) of S260 and S270 MCBs.

3 Phase + N, for use with 2 pole MCB's on 3 phase / 4W system

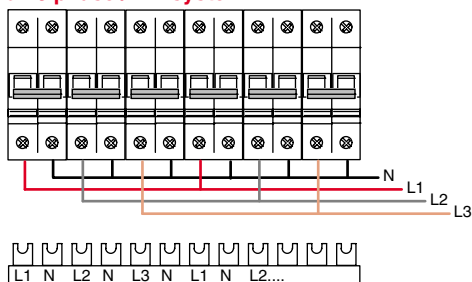

Amp rating	Number of poles	Busbar length	End cap catalog number	Catalog number	List price	Delivery class	Suggested order qty. quantity	Weight ounce (2 pc.)
50	58	1048	PSB-END4	SZ-PSB58N	\$ 198	B	1	22.3
65	58	1048	PSB-END4	SZ-PSB60N	238	A	1	30.8

Insulated busbar assembly contains 4 separate circuits for use with 1+N or 2 pole MCBs. For use on load side (bottom) of S260, S270, S280 and line side (top) of S280 MCBs.

MCB Busbar accessories

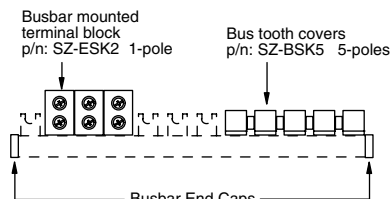

Description	Catalog number	List price	Delivery class	Suggested order qty.	Weight ounce qty. (2 pc.)
Busbar end caps	PSB-END3 PSB-END4 PSB-END5 PSB-END6	\$ 2	A	10	—
Busbar tooth covers (shrouds unused portion of busbar)	SZ-BSK5	4	A	10	—
IEC busbar mounted terminal block 1 pole, for use on all busbars	SZ-ESK2	10	A	1	1.0

Delivery Class

- A - Standard item, stock to 2 weeks lead time
- B - Stock to 4 weeks lead time
- C - 6 to 8 week lead time
- D - 10 to 12 week lead time
- E - Call for delivery



Accessories S260, S270 & S280

www.DataSheet4U.com

Pro M



S2-H11



S2-A1



S2-BM1



S2-S



S2-S/H



S2-NT

Electrical accessories	Catalog number	List price	Delivery class	Suggested order quantities	Wgt. oz. (1 pc.)
Auxiliary contacts					
For field mounting: left side					
1 N.O./ 1 N.C.	S2-H11	\$ 36	A	1	1.4
2 N.O.	S2-H20	36			
2 N.C.	S2-H02	36			
1 N.O./ 2 N.C.	S2-H12	54			
2 N.O./ 1 N.C.	S2-H21	54			
2 N.O./ 1 N.C. (low voltage)	S2-H21KL	60			

The S2-H11 auxiliary switch can be field mounted to any S260, S270 or S280 series breaker. The auxiliary contacts will signal whether the breaker is in the ON or OFF position. The contacts are rated 6A/240 VAC and 1.5A/110 VDC. Minimum operating voltage is 12 VAC/VDC.

Bell alarm

For field mounting, left side	S2-S	48	A	1	1.4
-------------------------------	------	----	---	---	-----

The S2-S bell alarm includes a set of contacts that will only signal when the breaker has tripped. Typically the contacts would be connected to an alarm or bell to signal the operator that an overcurrent trip has occurred. The bell alarm also includes a test button for testing the alarm contacts without opening the breaker. The contact is rated 6A/240 VAC and 1.5A/110 VDC. Minimum operating voltage is 12 VAC/VDC.

Bell alarm with auxiliary contact

For field mounting, left side	S2-S/H	58	A	1	1.4
-------------------------------	--------	----	---	---	-----

The S2-S/H bell alarm with auxiliary contact device combines one set of bell alarm contacts with one set of auxiliary contacts (N.O.).

Shunt trip

For field mounting, left side					
12-60 VAC (12-60VDC)	S2-A1	138	A	1	5.2
110-415 VAC (110-250 VDC)	S2-A2				

For remote tripping of breaker, a shunt trip device can be added to the MCB. The solenoid device opens the breaker after control voltage is applied. Shunt trips are available depending on control system voltage (12-415 VAC/VDC).

Undervoltage release

For field mounting, left or right side					
12V	S2-BM1	216	A	1	5.2
24V	S2-BM2				
48V	S2-BM3				
110V	S2-BM4				
220V	S2-BM5				
380V	S2-BM6				

When control voltage drops below approximately 50% of rated voltage, the S2-BM opens the breaker. The breaker can not be operated unless proper control voltage is first applied to the UVR coil. Similar in size and mounting to the shunt trip accessory; can be left or right side mounted.

Hand operated neutral disconnect

For field mounting, right side, 40A max.	S2-NT	27	A	1	1.4
--	-------	----	---	---	-----

When switching of neutral with breaker contacts is desired, the neutral module S2-NT can be added to any S260, S270 or S280 MCB. The neutral connection makes before the MCB contacts connect line to load. Makes contact before MCB contacts close. Must be opened manually.

Factory mounting

All accessories can be easily mounted in the field. For factory mounting of any accessory devices, add \$30 list to total price per breaker. To create complete catalog number, take suffix of accessory device following "S2-" and add suffix to end of breaker part number. Multiple suffixes must be added in alphabetical order.

Example: S272-K20A1 \$ 264 (2 pole, 20A breaker with type A1 shunt trip) S272-K20 @ \$96 + A1 @ \$138 + factory mounting @ \$30 = \$264
 S272-K20A2H11 \$ 300 (2 pole, 20A breaker with type A2 shunt trip and H11 aux. contacts) S272-K20 @ \$96 + A2 @ \$138 + H11 @ \$36 + factory mounting @ \$30 = \$300

Auxiliary contacts and shunt trips may be mounted in combination.

Delivery Class

- A - Standard item, stock to 2 weeks lead time
- B - Stock to 4 weeks lead time
- C - 6 to 8 week lead time
- D - 10 to 12 week lead time
- E - Call for delivery

NOTE: Above accessories are for use with types S260, S270 and S280 breakers only.

Accessories

S260, S270, S280

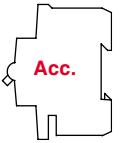

Electrical accessories	Catalog number	List price	Delivery class	Suggested order quantities	Wgt. oz. (1 pc.)
Front mounting kit					
For 2 poles	S500-ME1	\$ 60	A	1	2.1
For 2 – 5 poles	S500-ME2	70			2.9
For 2 – 10 poles	S500-ME3	80			3.6
Optional rear terminals (2 per kit)	MB-2RT	16			1.5

Includes flange, mounting rail, terminals for rear connection and hardware.

Front mounting clip					
For 1 – 4 poles	MB-CL	35	A	1	2

Simple mounting clip for up to four module mounting.

Front mounting bracket					
For 1 – 3 poles	MB-3PD	35	A	1	2.5

For flush mounting of three pole MCBs: includes hardware.

Pin-type connector					
2AWG (35mm ²)	SZ-AST35	9	A	10	0.5

Needed for connecting large cable 2AWG (35mm²) and busbar on same breaker.

Locking device					
Adaptor only	SA1	9	A	10	0.7
Padlock only w/ 2 keys	SA2	19			0.1

Allows breaker to be locked in ON or OFF position.

Labeling accessory					
1 sheet = 100 blank labels	STL-ST	74	A	1	—
1 sheet = 100 numbered labels					

Snaps into rail indent on front of MCB Label holder & labels includes 100 label carriers.

Enclosure, IP55					
For 4 modules	12644	84	A	1	8.1
For 6 modules	12646	98			10.8
For 10 modules	12650	126			20.4
For 20 modules	12652	210			41.0

Molded plastic complete with mounting rail and knock-outs for cable entries.

Blanking plates					
Single pole (set of 10)	BP-1P	6	A	1	—
Twelve pole (snap-off, set of 1)	BP-12P	7	—	—	—

Terminal covers					
For 2 modules	PCD2	32	A	1	2.0
For 4 modules	PCD4	45			2.8
For 6 modules	PCD6	56			3.4
For 8 modules	PCD8	66			4.1

For additional protection against accidental contact. Includes integrated mounting rail.

Handle mechanism					
	RHS2-M	76	A	1	9.2

For use with 2, 3 and 4 pole S2 MCBs and disconnect switch selector handles with 5mm shaft.

Mounting rail					
Universal mounting	SMR-39	21	A	1	8

35mm DIN rails are available in 39-inch strips (1 meter).

Delivery Class

- A - Standard item, stock to 2 weeks lead time
- B - Stock to 4 weeks lead time
- C - 6 to 8 week lead time
- D - 10 to 12 week lead time
- E - Call for delivery

Technical data

Mounting and operating instructions

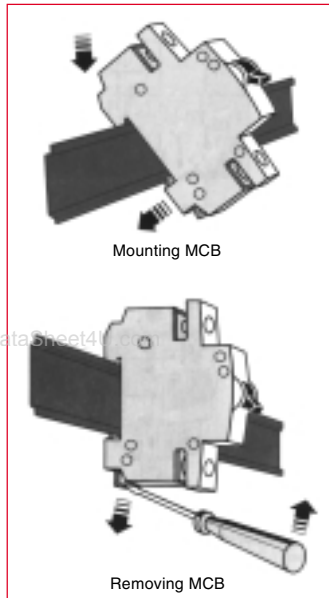

Mounting

Universal mounting position using snap-on mounting to standard 35x7.5mm DIN rail.

Miniature circuit breakers (MCBs) can also be mounted to front of door using a panel cut-out with breaker handle protruding through panel opening for external operation. Special front mounting kit type ME is available (see page 2.12).

Connection

Terminals are suitable for solid or flexible conductors from 18 to 4 AWG (0.75 to 25mm²) with no busbar connected. When maximum busbar size of 36 mm² is used, maximum cable is 6 AWG (16 mm²).

Maximum tightening torque of 17.5 in-lb (2 Nm) for line/load terminals and 4.5 in-lb (0.5Nm) for accessory device terminals.

Operation

MCBs are switched on by moving the handle to the upper position. Stamped onto the handle switch, a "I" is visible confirming that the breaker is closed.

The MCBs are "trip-free," if the handle is being forced to the "ON" position, the breaker will still trip under fault conditions.

The "O" marking indicates that the breaker is in the "OFF" position. The MCB is now open and the load is disconnected from line power.

When a breaker has tripped, the MCB handle should first be set to the full "OFF" position to make certain the trip mechanism has been reset. Once the fault has been determined and cleared the MCB can again be switched "ON".

Maintenance

ABB miniature circuit breakers require no special maintenance; only normal electrical system maintenance procedures are required.

Pro M

Possible mounting arrangements of MCB accessories

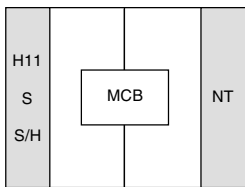

Auxiliary switch/bell alarm neutral disconnect

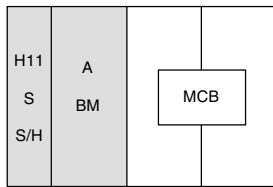

Shunt trip or undervoltage release mounted with auxiliary switch

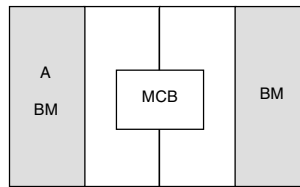

Shunt trip and/or undervoltage release

Auxiliary switch

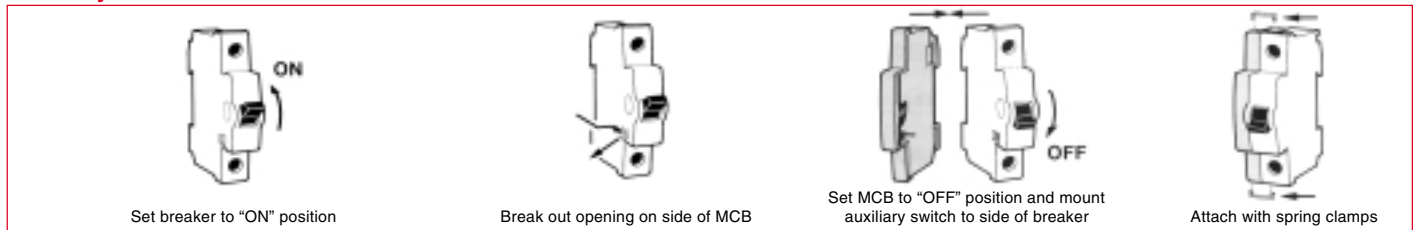

Bell alarm with auxiliary contact

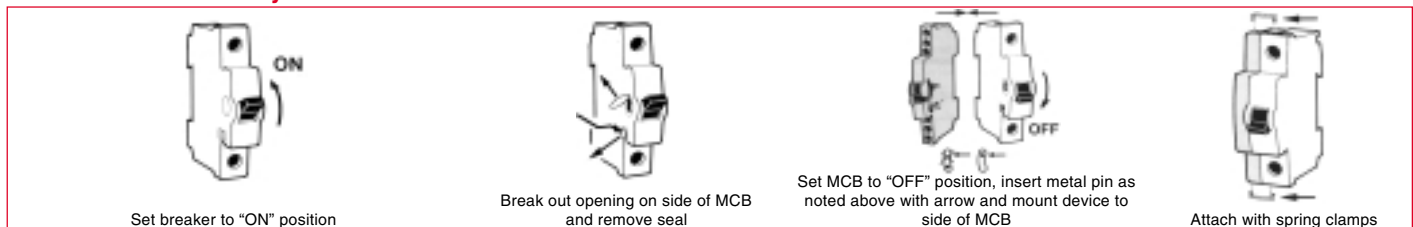

Shunt trip and undervoltage release

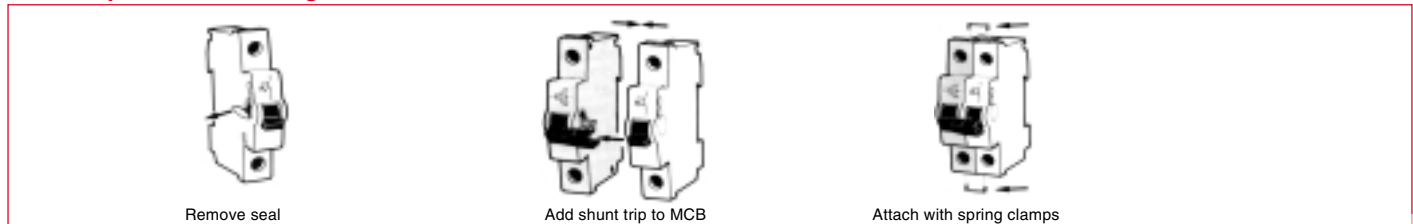

Technical data

Busbars & connectors

Connection methods

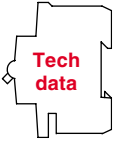

Dual function terminals provided in open position for connection to busbars. Pressing on screw head opens box terminal for cable insertion. Only the lower terminal is dual function.

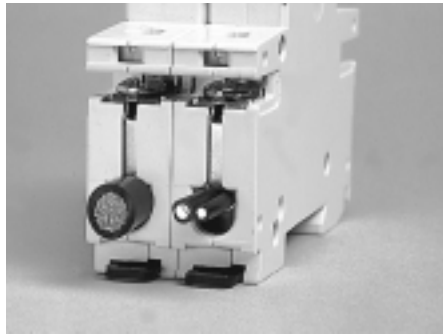

Terminals allow for connection of cable 18-4 AWG. Conductors of different sizes may also be used in same terminal.

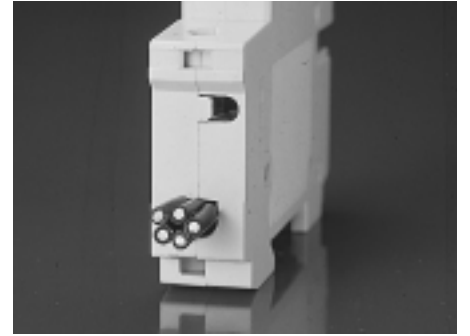

Up to five conductors, 16 AWG each, can be safely connected per terminal.



Lower terminals can be bussed together with single phase or multi-phase busbars as shown. Upper terminals can also be busbar connected.

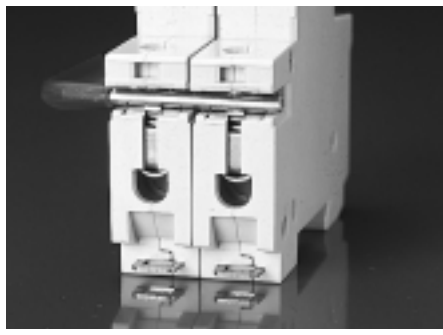

Lower terminal can also be bussed with solid round conductor.

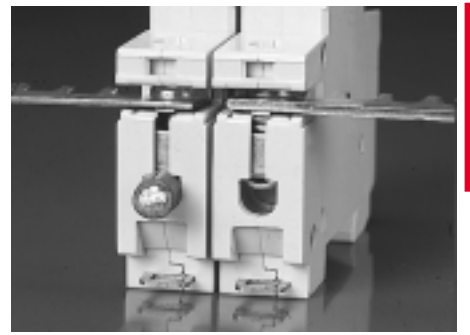

Cables can be connected to box terminals in addition to busbar connections on lower, dual function terminals.

Pro M



Technical data

S260, S270, & S280

Item	S260-B		S260-C, -D		S270-K		S280-K	
Approvals:	1077		1077		1077		1077	
UL	C22.2 — No.235		C22.2 — No. 235		C22.2 — No. 235		C22.2 — No. 235	
CSA	0641, 0660		0660		0660		0660	
VDE	898, 947		898, 947		898, 947		898, 947	
IEC								
No. of poles:	1,2,3,4 1+N,3+N		1,2,3		1,2,3,4, 1+N,3+N		1,2,3,4,1+N,3+N	
Tripping characteristic:	B		C,D		K		K	
Rated currents:	6 to 63A		0.5 to 63A		0.5 to 63A		0.2 to 63A	
Minimum operating voltage:	12V		12V		12V		12V	
UL/CSA rated voltage & interrupting capacity	Single pole	Multi pole	Single pole	Multi pole	Single pole	Multi pole	Single pole	Multi pole
120VAC	10kA	—	10kA	—	10kA	—	10kA for 0.2-40A 6kA for 50-63A	—
240VAC	6kA	10kA	6kA	10kA	6kA	10kA	10kA for 0.2-40A 6kA for 50-63A	10kA for 0.2-32A 6kA for 40-63A
277VAC	6kA	—	6kA	—	6kA	—	10kA for 0.2-40A	—
277/480 VAC	—	6kA	—	6kA	—	6kA	—	10kA for 0.2-32A 6kA for 40-63A
60VDC	10kA	10kA	10kA	10kA	10kA	10kA	—	—
125VDC	—	10kA	—	10kA	—	10kA	—	—
Frequency:	50/60Hz (See below)		50/60Hz (see below)		50/60Hz (see below)		50/60Hz (see below)	
Rated voltage	240/415VAC		240/415VAC		240/415VAC		240/415VAC	
IEC single pole	60VDC		60VDC		60VDC		60VDC	
IEC multi-pole	415VAC		415VAC		415VAC		415VAC	
	110VDC		110VDC		110VDC		110VDC	
Protection category:	IP20		IP20		IP20		IP20	
Depth of unit per DIN 43880:	68mm		68mm		68mm		68mm	
Mounting position:	optional		optional		optional		optional	
Standard mounting:	35mm DIN rail		35mm DIN rail		35mm DIN rail		35mm DIN rail	
Terminals:	Conductors from 18-4AWG (0.75 – 25sq mm)		Conductors from 18-4AWG (0.75 – 25sq mm)		Conductors from 18-4AWG (0.75 – 25sq mm)		Conductors from 18-4AWG (0.75 – 25sq mm)	
	50A and above Conductors from 18-2AWG (0.75 – 35sq mm)		50A and above Conductors from 18-2AWG (0.75 – 35sq mm)		50A and above Conductors from 18-2AWG (0.75 – 35sq mm)		50A and above Conductors from 18-2AWG (0.75 – 35sq mm)	
Service life at rated load:	20,000 operations		20,000 operations		20,000 operations		20,000 operations	
Ambient temperatures:	-25°C to +55°C		-25°C to +55°C		-25°C to +55°C		-25°C to +55°C	
Shock resistance:	10g minimum of 20 impacts, shock duration of 13ms		10g minimum of 20 impacts, shock duration of 13ms		10g minimum of 20 impacts, shock duration of 13ms		10g minimum of 20 impacts, shock duration of 13ms	
Vibration resistance:	5g, minimum of 30 minutes		5g, minimum of 30 minutes		5g, minimum of 30 minutes		5g, minimum of 30 minutes	
Disconnecting neutral rating:	6kA switching		6kA switching		6kA switching		—	

Influence of frequency on electro-magnetic trips

Magnetic trip values shown on trip curves are valid for 50/60Hz applications. For frequencies other than 50/60Hz, the magnetic (instantaneous) trip values are increased by the factor given below:

	16 2/3 - 60Hz	100Hz	200Hz	400Hz	DC
Approx. factor	1	1.1	1.2	1.5	1.5

Thermal tripping is independent of frequency.

Technical data

S280, S280UC, S290



Item	S280UC-K		S280-Z		S280UC-Z		S290-C
Approvals:	1077		1077		1077		—
UL	C22.2 — No. 235		C22.2 — No. 235		C22.2 — No. 235		—
CSA	0660		0660		0660		0660
VDE	898,947		898, 947		898, 947		898
IEC	—		—		—		—
No. of poles:	1,2,3		1,2,3,4		1,2,3		1,2,3,4
Tripping characteristic:	K		Z		Z		C
Rated currents:	0.2 to 63A		0.5 to 63A		0.5 to 63A		80 to 125A
Minimum operating voltage:	12V		12V		12V		12V
UL/CSA rated voltage & interrupting capacity	<u>Single pole</u>	<u>Multi pole</u>	<u>Single pole</u>	<u>Multi pole</u>	<u>Single pole</u>	<u>Multi pole</u>	
120VAC	6kA for 0.2-40A 5kA for 50-63A	—	10kA for 0.2-40A 6kA for 50-63A	—	6kA for 0.2-40A 5kA for 50-63A	—	—
240VAC	6kA for 0.2-40A 5kA for 50-63A	6kA for 0.2-40A 5kA for 50-63A	10kA for 0.2-40A 6kA for 50-63A	10kA for 0.2-32A 6kA for 40-63A	6kA for 0.2-40A 5kA for 50-63A	6kA for 0.2-40A 5kA for 50-63A	—
277VAC	4.5kA for 0.2-40A 5kA for 50-63A	—	10kA for 0.2-40A 6kA for 50-63A	—	4.5kA for 0.2-40A 5kA for 50-63A	—	—
277/480 VAC	—	4.5kA for 0.2-40A 5kA for 50-63A	—	10kA for 0.2-32A 6kA for 40-63A	—	4.5kA for 0.2-40A 5kA for 50-63A	—
60VDC	10kA	10kA	—	—	10kA	10kA	—
125VDC	10kA	10kA	—	—	10kA	10kA	—
250VDC	4.5kA	4.5kA	—	—	4.5kA	4.5kA	—
500VDC	—	4.5kA	—	—	—	4.5kA	—
Frequency:	50/60Hz (see below)		50/60 Hz (see below)		50/60Hz (see below)		50/60Hz (see below)
Rated voltage	240/415VAC		240/415VAC		240/415VAC		230/440VAC
IEC single pole	220VDC		60VDC		220VDC		60VDC
IEC multi-pole	415VAC		415VAC		415VAC		440VAC
	440VDC		110VDC		440VDC		110VDC
Protection category:	IP20		IP20		IP20		IP20
Depth of unit per DIN 43880:	68mm		68mm		68mm		70mm
Mounting position:	optional		optional		optional		optional
Standard mounting:	35mm DIN rail		35mm DIN rail		35mm DIN-rail		35mm DIN-rail
Terminals:	Conductors from 18-4AWG (0.75 – 25sq mm)		Conductors from 18-4AWG (0.75 – 25sq mm)		Conductors from 18-4AWG (0.75 – 25sq mm)		Conductors from 14-1/0AWG (1.5 – 50sq mm)
	50A and above		50A and above		50A and above		—
	Conductors from 18-2AWG (0.75 – 35sq mm)		Conductors from 18-2AWG (0.75 – 35sq mm)		Conductors from 18-2AWG (0.75 – 35sq mm)		—
	—		—		—		—
Service life at rated load:	20,000 operations		20,000 operations		20,000 operations		10,000 operations
Ambient temperatures:	-25°C to +55°C		-25°C to +55°C		-25°C to +55°C		-5°C to +45°C
Shock resistance:	10g minimum of 20 impacts, shock duration of 13ms		10g minimum of 20 impacts, shock duration of 13ms		10g minimum of 20 impacts, shock duration of 13ms		30g minimum of 20 impacts, shock duration of 13ms
Vibration resistance:	5g, minimum of 30 minutes		5g, minimum of 30 minutes		5g, minimum of 30 minutes		60m/s ² , at 10 – 150 Hz

Influence of frequency on electro-magnetic trips

Magnetic trip values shown on trip curves are valid for 50/60Hz applications. For frequencies other than 50/60Hz, the magnetic (instantaneous) trip values are increased by the factor given below:

	16 2/3 - 60Hz	100Hz	200Hz	400Hz	DC
Approx. factor	1	1.1	1.2	1.5	1.5

Thermal tripping is independent of frequency.

Pro M



Technical data

Let-through values

Description

All ABB miniature circuit breakers substantially reduce the maximum let-through current from the peak available short circuit current.

- I_K - RMS current of fault
- I_D - Max let-through of MCB
- V_n - System voltage
- V_B - Arc voltage of MCB
- t_k - Breaking time of MCB

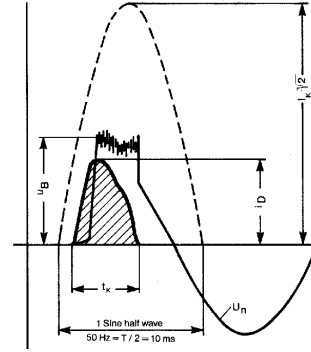

www.DataSheet4U.com

Let-through values I^2t

S260-B

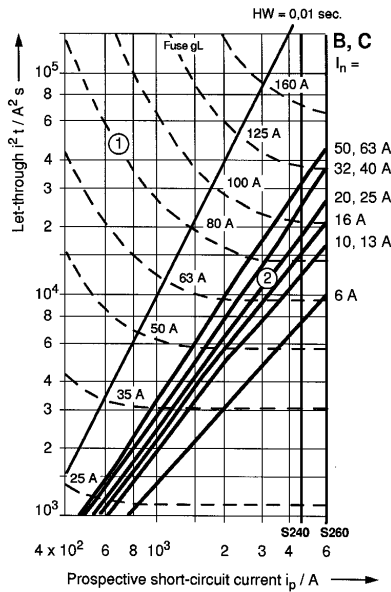

S270-K

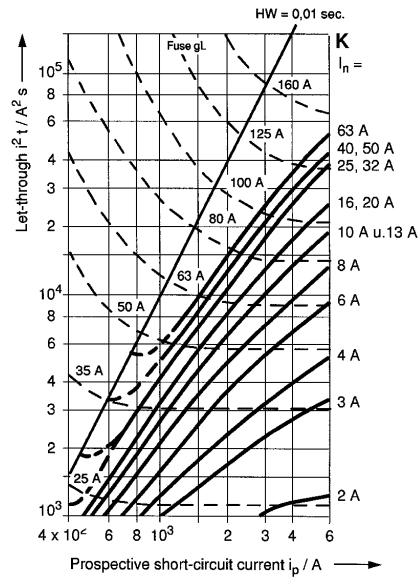

S280-K

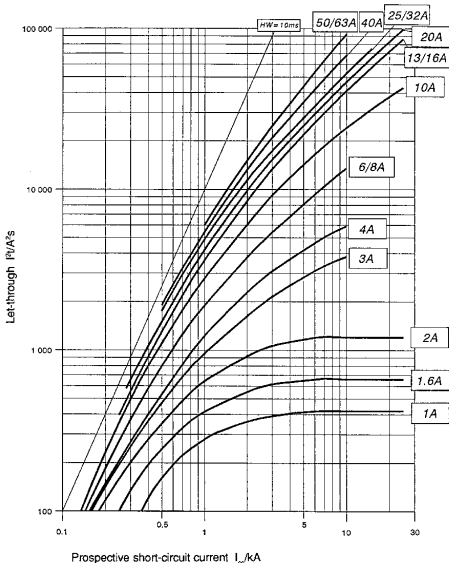

For other curves, please contact ABB Control.

Version	I^2t	I Peak
S260B	TD9980	—
S260C	TD9981	—
S260D	TD9982	—
S270K	TD9972	TD9950
S280K	TD9978	—
S280Z	TD9979	—
S290C	TD9985	—
Version	Amps	Time-current trip
S260B	6 - 63	TD9725
S270K	0.5 - 8	TD9705
	10 - 40	TD9706
	50 - 63	TD9707
S280K	0.2 - 8	TD9708
	10 - 40	TD9709
	50 - 63	TD9710
S280Z	0.5 - 63	TD9711

Technical data

Temperature derating factors

Terminal markings

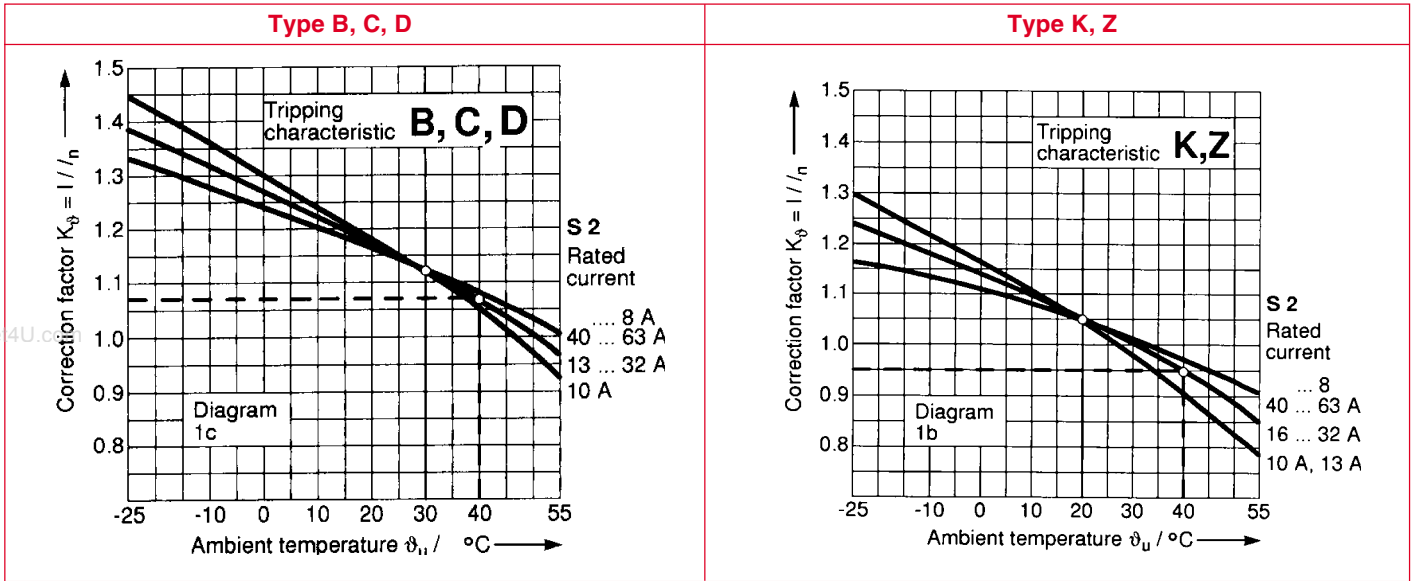
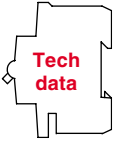

Current carrying capacity of type "B", "C", "D", "K" and "Z" thermal trip characteristics as a function of ambient temperature.

Terminal markings

Input optional from top or bottom.

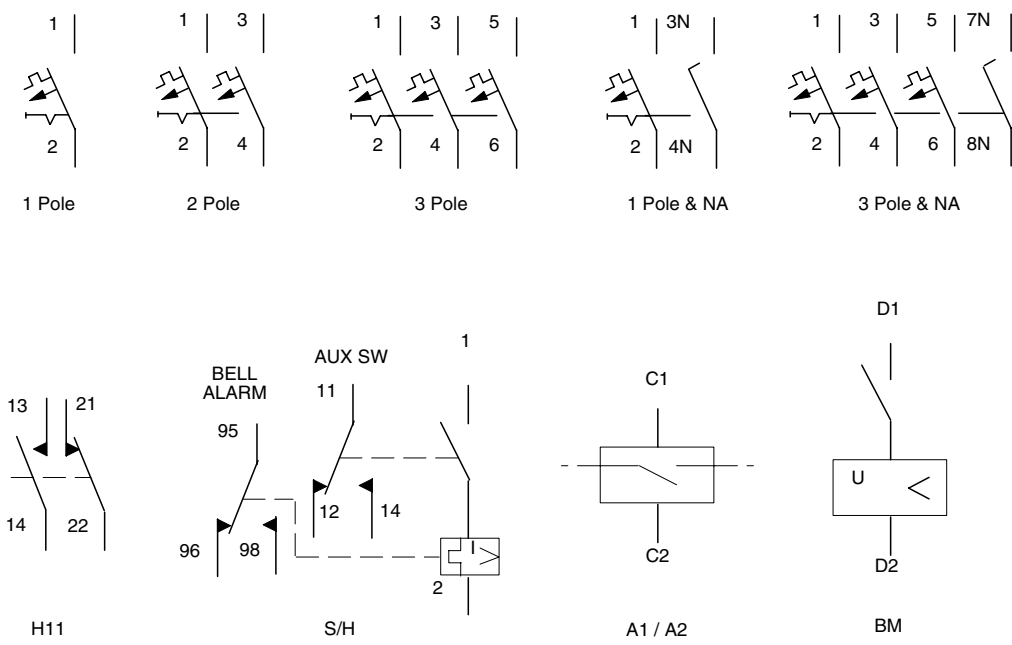

Pro M



Technical data

Breaker resistance values & wire size comparison

Miniature circuit breaker resistance values

Ampere rating	Milliohms			
	S260-B	S270-K	S280-K	S280-Z
0.2	—	—	33300	—
0.3	—	—	19700	—
0.5	—	6340	5020	10100
0.75	—	—	2400	—
1.0	—	1550	1390	2270
1.6	—	695	612	1100
2	—	460	450	619
3	—	165	147	202
4	—	120	112	149
6	55	52	54.1	104
8	15	38	33.8	53.9
10	13.3	12.6	15.1	17.5
12	13.3	12.6	—	—
16	7.0	7.7	8.1	10.9
20	6.25	6.7	5.27	6.0
25	5.0	4.6	3.97	4.1
32	3.6	3.5	2.65	2.81
40	3.0	2.8	2.44	2.55
50	1.2	1.15	1.15	1.77
63	1.4	0.70	0.70	1.31

Comparison of IEC and AWG wire sizes

mm	AWG (mm)	Amps / UL	Amps / IEC
1.0	—	—	8
—	16 (1.3)	10	—
1.5	—	—	12
—	14 (2.1)	15	—
2.5	—	—	20
—	12 (3.3)	20	—
4	—	—	25
—	10 (5.3)	30	—
6	—	—	32
—	8 (8.4)	50	—
10	—	—	50
—	6 (13.3)	65	—
16	—	—	65
—	4 (21.2)	85	—
25	—	—	85
—	3 (26.7)	100	—
—	2 (33.6)	115	—
35	—	—	115

Ampacities for AWG wire are based on copper cable rated 75° C, except for 16AWG which is based on 60° C wire. Taken from UL508 Table 52.2.

Consult applicable standards for further detail and information.

00.00 Inches
00.00 Millimeters

Approximate dimensions S260, S270, S280, S290

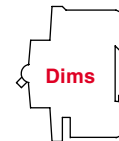

S260 & S270

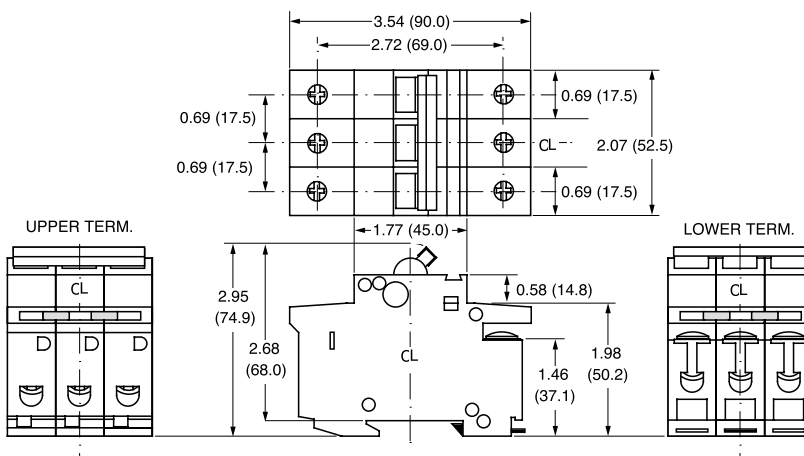

S280

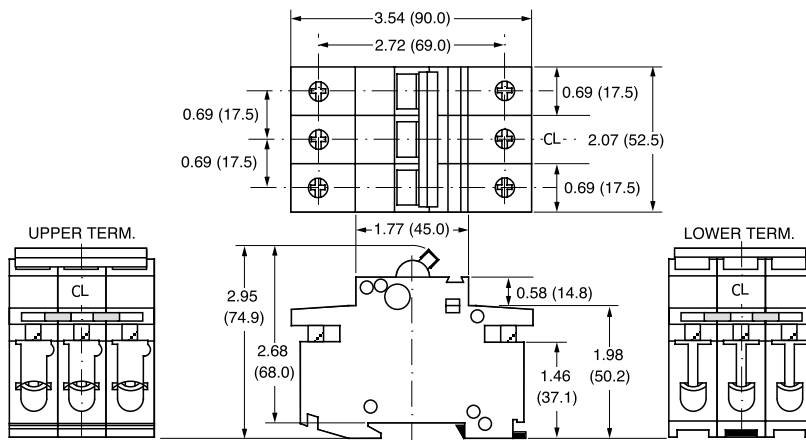

S290

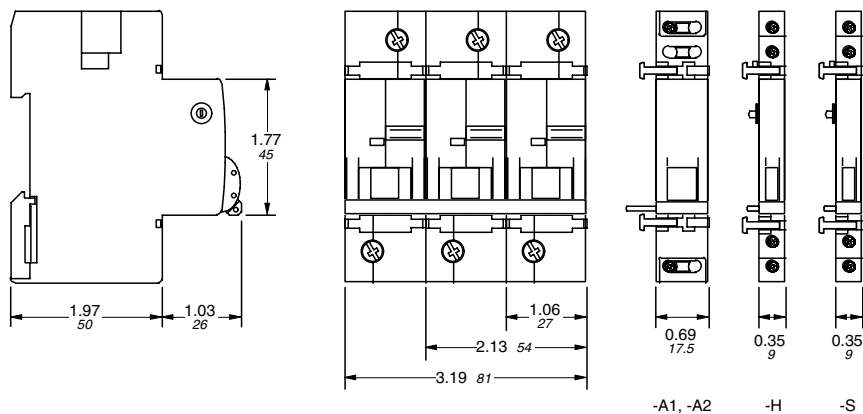

Pro M

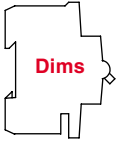

Approximate dimensions Accessories

← 00.00 Inches
00.00 → Millimeters

Accessories

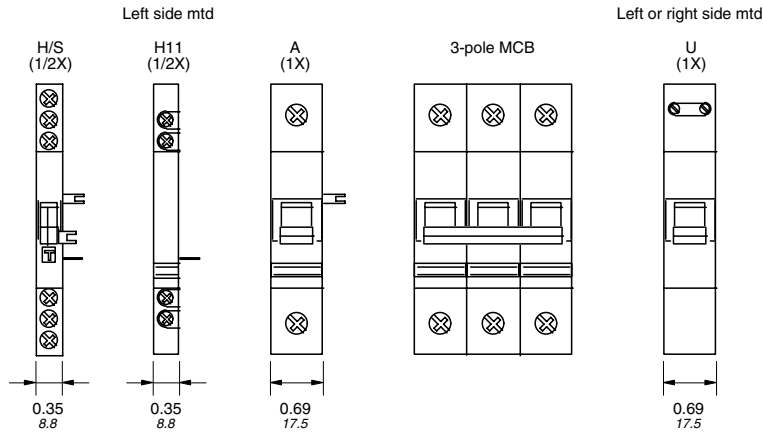

www.DataSheet4U.com

MB-CL

Pro M

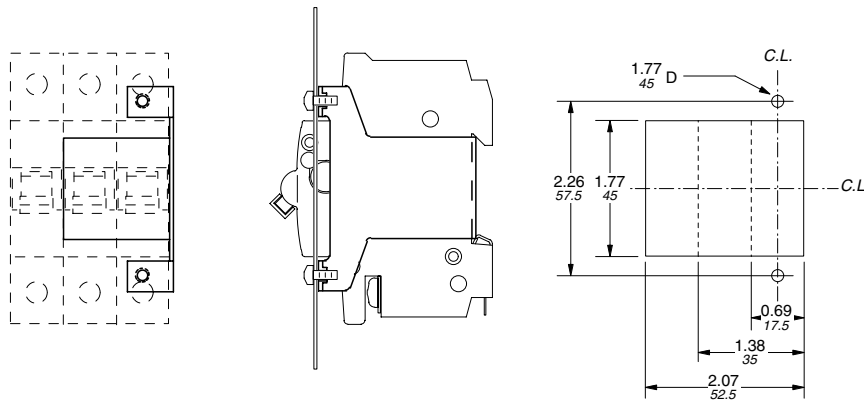

MB-3PD

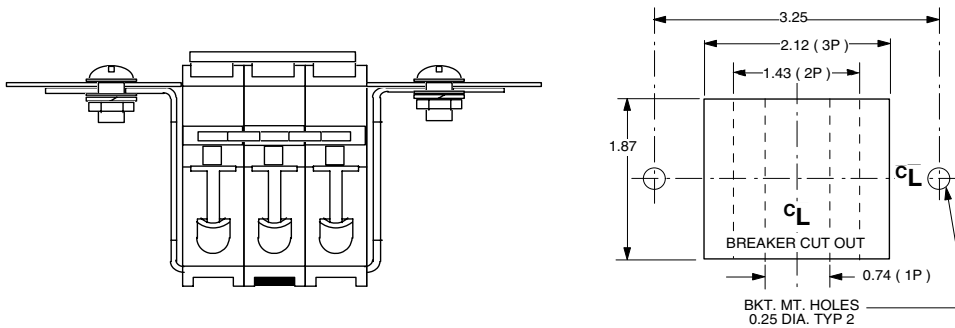

RHS2-M

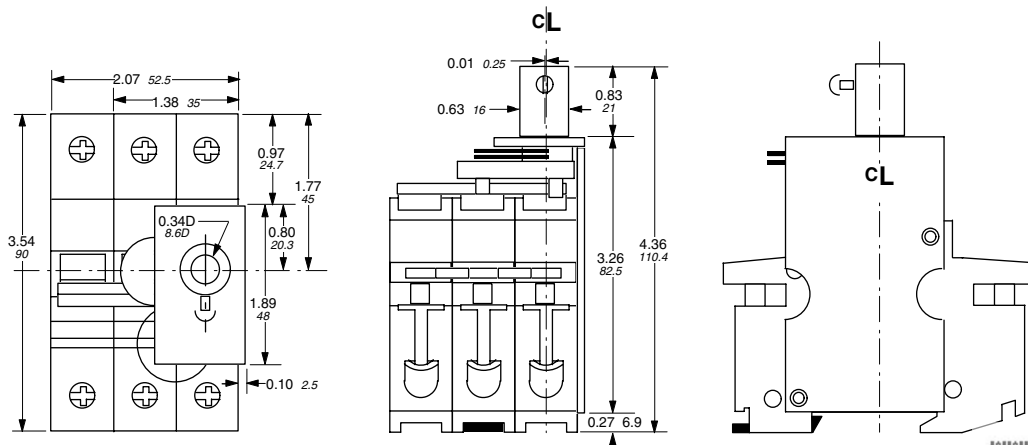

www.DataSheet4U.com
ABB Control Inc.

00.00 Inches
00.00 Millimeters

Approximate dimensions Accessories

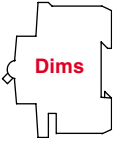

12644

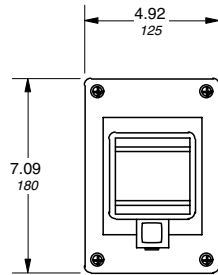
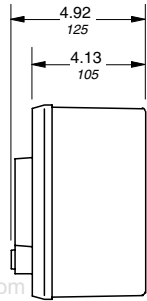

12650

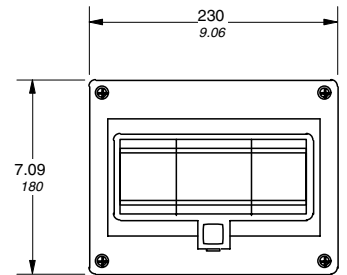

12646

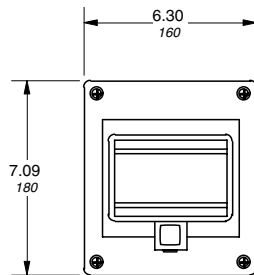
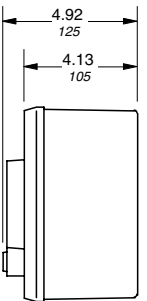

12656

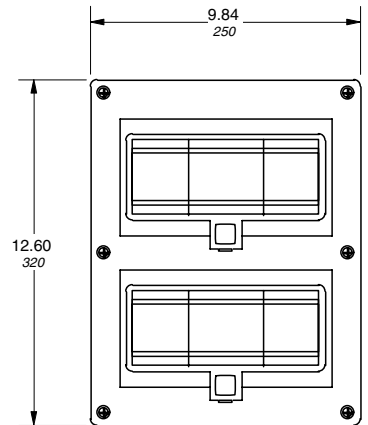
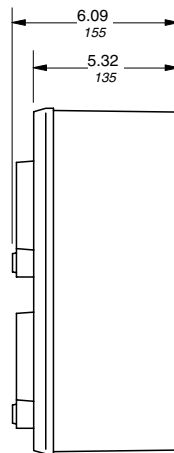

Pro M



Cross-reference

Older version	Suggested replacement series	Physical comparison	Electrical comparison
S160L	S260B	Same pole spacing	Same trip characteristic as "L"
S160K	S270K	Same pole spacing	Same trip characteristic as "K" S270 is 6kA IC
S210L	S260B	Same pole spacing	Same trip characteristic as "L" S260B is 6kA IC
S210K	S280K	Same pole spacing	Same trip characteristic as "K" S280K is 6kA IC
S210Z	S280Z	Same pole spacing	Same trip characteristic as "Z"
S250L	S260B	Same pole spacing	Same trip characteristic as "L"
S210-UCK	S280UC-K	Same pole spacing	Same trip characteristic as "K"
S210-UCZ	S280UC-Z	Same pole spacing	Same trip characteristic as "Z"
S220-K	S500-K	Different pole spacing	Same trip characteristic as "K"
S230-B	S260-B	Same pole spacing	Same trip characteristic as "B"

Many older styles of ABB miniature circuit breakers have been replaced by new and improved versions. Many of these newer styles can be directly interchanged, both electrically and physically, with the older version. There are also many international styles of ABB circuit breakers which are not normal stock items and may be interchanged with stocked ABB versions.

Note: MCB types S260/270 and S280 can be raised to the same height as older style S210 series MCBs through the use of a height adjuster (SZ-ES68/83; \$ 30 list per 20). The height adjuster snaps onto the DIN rail and raises the height of components 68mm to match that of the S210 series (83mm).



Pro M Miniature Circuit Breakers S500

www.DataSheet4U.com



Pro M

Description

Increasing energy requirements result in larger short-circuit currents which place heavy demands on protective switchgear regarding safety, reliability and switching capacities.

The S500 heavy-duty circuit breaker fulfills these requirements by virtue of its technical features. It is equipped with a thermal and/or electromagnetic release to protect circuits, motors, switchgear and systems from the effects of overload and short-circuit currents.

For the worldwide market, the S500 breakers carry UL, CSA, IEC, CE and many other agency approvals.

Features

- High breaking capacity
- Energy-limiting
- Current-limiting
- Extremely fast breaking time
- Optimal selectivity
- Various versions for special applications
- Compact dimensions, DIN cap size
- Easy and quick to install
- Easy to connect; finger safe terminals
- Wide range of accessories
- UL 1077 recognized 600VAC and 500VDC versions

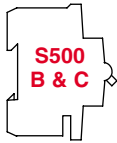

S500 277/600 VAC

Pro M



S501-C16



S502-C6

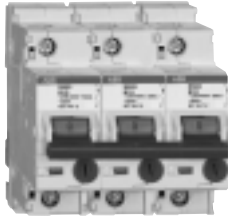

S503-C10

B

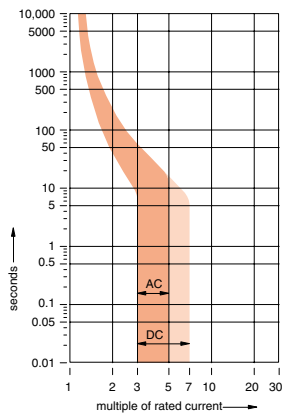

C

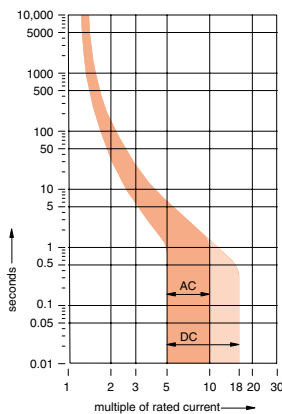

B UL 1077 CSA C22.2
VDE 0641 IEC 947-2

Rated current	Catalog number	List price	Delivery class	Weight (oz.) 1 pc
6	S501-B6	\$ 168	B	8.90
10	S501-B10	168		
13	S501-B13	168		
16	S501-B16	168		
20	S501-B20	168		
25	S501-B25	168		
32	S501-B32	168		
40	S501-B40	168		
50	S501-B50	186		
63	S501-B63	202		
6	S502-B6	328	B	17.85
10	S502-B10	328		
13	S502-B13	328		
16	S502-B16	328		
20	S502-B20	328		
25	S502-B25	328		
32	S502-B32	328		
40	S502-B40	328		
50	S502-B50	362		
63	S502-B63	392		
6	S503-B6	478	B	25.36
10	S503-B10	478		
13	S503-B13	478		
16	S503-B16	478		
20	S503-B20	478		
25	S503-B25	478		
32	S503-B32	478		
40	S503-B40	478		
50	S503-B50	526		
63	S503-B63	574		

C UL 1077 CSA C22.2
VDE 0641 IEC 947-2

Rated current	Catalog number	List price	Delivery class	Weight (oz.) 1 pc
6	S501-C6	\$ 168	B	8.90
10	S501-C10	168		
13	S501-C13	168		
16	S501-C16	168		
20	S501-C20	168		
25	S501-C25	168		
32	S501-C32	168		
40	S501-C40	168		
50	S501-C50	184		
63	S501-C63	202		
6	S502-C6	328	B	17.85
10	S502-C10	328		
13	S502-C13	328		
16	S502-C16	328		
20	S502-C20	328		
25	S502-C25	328		
32	S502-C32	328		
40	S502-C40	328		
50	S502-C50	362		
63	S502-C63	392		
6	S503-C6	478	B	25.36
10	S503-C10	478		
13	S503-C13	478		
16	S503-C16	478		
20	S503-C20	478		
25	S503-C25	478		
32	S503-C32	478		
40	S503-C40	478		
50	S503-C50	526		
63	S503-C63	574		

Delivery Class

- A - Standard item, stock to 2 weeks lead time
- B - Stock to 4 weeks lead time
- C - 6 to 8 week lead time
- D - 10 to 12 week lead time
- E - Call for delivery

S500 277/600 VAC

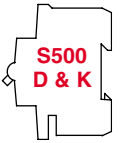

S501-D20



S502-D13

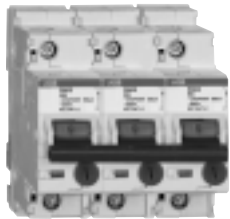

S503-K6

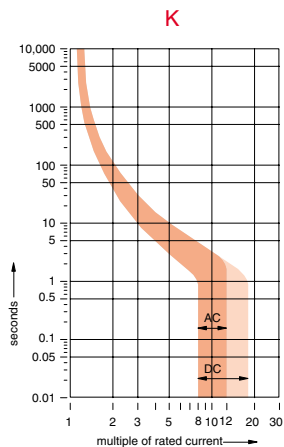
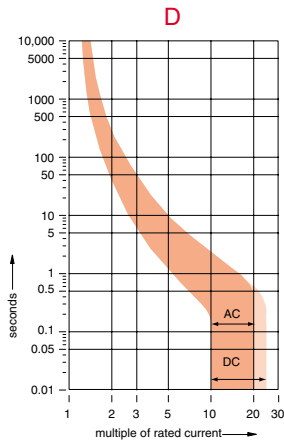

D UL 1077 CSA C22.2
VDE 0641 IEC 947-1

Rated current	Catalog number	List price	Delivery class	Wgt. oz. (1 Pc.)
13	S501-D13	\$ 190	B	8.90
16	S501-D16	190		
20	S501-D20	190		
25	S501-D25	190		
32	S501-D32	190		
40	S501-D40	190		
50	S501-D50	210		
63	S501-D63	226		
13	S502-D13	372	B	17.85
16	S502-D16	372		
20	S502-D20	372		
25	S502-D25	372		
32	S502-D32	372		
40	S502-D40	372		
50	S502-D50	408		
63	S502-D63	442		
13	S503-D13	544	B	25.36
16	S503-D16	544		
20	S503-D20	544		
25	S503-D25	544		
32	S503-D32	544		
40	S503-D40	544		
50	S503-D50	600		
63	S503-D63	646		

K UL 1077 CSA C22.2
VDE 0641 IEC-898

Rated current	Catalog number	List price	Delivery class	Wgt. oz. (1 Pc.)
0.1 – 0.15	S501-K0.15	\$ 182	B	8.90
0.14 – 0.21	S501-K0.21	182		
0.2 – 0.3	S501-K0.3	182		
0.28 – 0.42	S501-K0.42	182		
0.38 – 0.58	S501-K0.58	182		
0.53 – 0.8	S501-K0.8	182		
0.73 – 1.1	S501-K1.1	182		
1 – 1.5	S501-K1.5	182		
1.4 – 2.1	S501-K2.1	182		
2 – 3	S501-K3	182		
2.8 – 4.2	S501-K4.2	182		
3.8 – 5.8	S501-K5.8	182		
5.3 – 8	S501-K8	182		
7.3 – 11	S501-K11	182		
10 – 15	S501-K15	182		
14 – 20	S501-K20	182		
18 – 26	S501-K26	182		
23 – 32	S501-K32	202		
29 – 37	S501-K37	202		
34 – 41	S501-K41	226		
38 – 45	S501-K45	226		
0.1 – 0.15	S502-K0.15	356	B	17.85
0.14 – 0.21	S502-K0.21	356		
0.2 – 0.3	S502-K0.3	356		
0.28 – 0.42	S502-K0.42	356		
0.38 – 0.58	S502-K0.58	356		
0.53 – 0.8	S502-K0.8	356		
0.73 – 1.1	S502-K1.1	356		
1 – 1.5	S502-K1.5	356		
1.4 – 2.1	S502-K2.1	356		
2 – 3	S502-K3	356		
2.8 – 4.2	S502-K4.2	356		
3.8 – 5.8	S502-K5.8	356		
5.3 – 8	S502-K8	356		
7.3 – 11	S502-K11	356		
10 – 15	S502-K15	356		
14 – 20	S502-K20	356		
18 – 26	S502-K26	356		
23 – 32	S502-K32	392		
29 – 37	S502-K37	392		
34 – 41	S502-K41	442		
38 – 45	S502-K45	442		
0.1 – 0.15	S503-K0.15	518	B	25.36
0.14 – 0.21	S503-K0.21	518		
0.2 – 0.3	S503-K0.3	518		
0.28 – 0.42	S503-K0.42	518		
0.38 – 0.58	S503-K0.58	518		
0.53 – 0.8	S503-K0.8	518		
0.73 – 1.1	S503-K1.1	518		
1 – 1.5	S503-K1.5	518		
1.4 – 2.1	S503-K2.1	518		
2 – 3	S503-K3	518		
2.8 – 4.2	S503-K4.2	518		
3.8 – 5.8	S503-K5.8	518		
5.3 – 8	S503-K8	518		
7.3 – 11	S503-K11	518		
10 – 15	S503-K15	518		
14 – 20	S503-K20	518		
18 – 26	S503-K26	518		
23 – 32	S503-K32	574		
29 – 37	S503-K37	574		
34 – 41	S503-K41	644		

Pro M

Delivery Class

- A** - Standard item, stock to 2 weeks lead time
- B** - Stock to 4 weeks lead time
- C** - 6 to 8 week lead time
- D** - 10 to 12 week lead time
- E** - Call for delivery

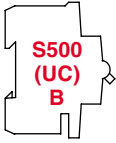

S500UC 600 VAC/VDC

B UL 1077 CSA C22.2
VDE 0660



S501UC-B40



S502UC-B16

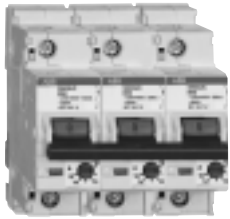

S503UC-B50

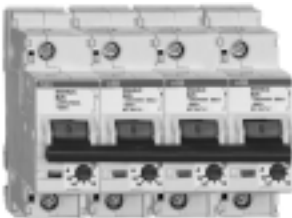

S504UC-B25

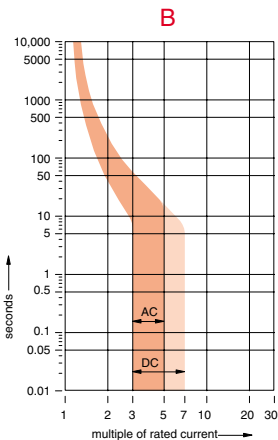

Rated current	Catalog number	List price	Delivery class	Weight (oz.) 1 pc
6	S501UC-B6	\$ 226	C	8.90
10	S501UC-B10	226		
13	S501UC-B13	226		
16	S501UC-B16	226		
20	S501UC-B20	226		
25	S501UC-B25	226		
32	S501UC-B32	226		
40	S501UC-B40	226		
50	S501UC-B50	258		
63	S501UC-B63	292		
6	S502UC-B6	442	C	17.85
10	S502UC-B10	442		
13	S502UC-B13	442		
16	S502UC-B16	442		
20	S502UC-B20	442		
25	S502UC-B25	442		
32	S502UC-B32	442		
40	S502UC-B40	442		
50	S502UC-B50	502		
63	S502UC-B63	568		

Rated current	Catalog number	List price	Delivery class	Weight (oz.) 1 pc
6	S503UC-B6	\$ 646	C	25.36
10	S503UC-B10	646		
13	S503UC-B13	646		
16	S503UC-B16	646		
20	S503UC-B20	646		
25	S503UC-B25	646		
32	S503UC-B32	646		
40	S503UC-B40	646		
50	S503UC-B50	734		
63	S503UC-B63	832		
6	S504UC-B6	908	C	35.75
10	S504UC-B10	908		
13	S504UC-B13	908		
16	S504UC-B16	908		
20	S504UC-B20	908		
25	S504UC-B25	908		
32	S504UC-B32	908		
40	S504UC-B40	908		
50	S504UC-B50	1030		
63	S504UC-B63	1164		

Delivery Class

- A - Standard item, stock to 2 weeks lead time
- B - Stock to 4 weeks lead time
- C - 6 to 8 week lead time
- D - 10 to 12 week lead time
- E - Call for delivery

Pro M

S500 UC 600 VAC/VDC

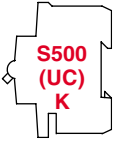

K UL 1077 CSA C22.2
VDE 0660



S503UC-K8

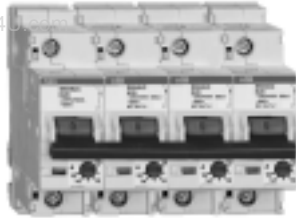

S504UC-K20

Rated current	Catalog number	List price	Delivery class	Weight (oz.) 1 pc	Rated current	Catalog number	List price	Delivery class	Weight (oz.) 1 pc
0.1 – 0.15	S501UC-K0.15	\$ 250	C	8.90	0.1 – 0.15	S503UC-K0.15	\$ 712	C	25.36
0.14 – 0.21	S501UC-K0.21	250			0.14 – 0.21	S503UC-K0.21	712		
0.2 – 0.3	S501UC-K0.3	250			0.2 – 0.3	S503UC-K0.3	712		
0.28 – 0.42	S501UC-K0.42	250			0.28 – 0.42	S503UC-K0.42	712		
0.38 – 0.58	S501UC-K0.58	250			0.38 – 0.58	S503UC-K0.58	712		
0.53 – 0.8	S501UC-K0.8	250			0.53 – 0.8	S503UC-K0.8	712		
0.73 – 1.1	S501UC-K1.1	250			0.73 – 1.1	S503UC-K1.1	712		
1 – 1.5	S501UC-K1.5	250			1 – 1.5	S503UC-K1.5	712		
1.4 – 2.1	S501UC-K2.1	250			1.4 – 2.1	S503UC-K2.1	712		
2 – 3	S501UC-K3	250			2 – 3	S503UC-K3	712		
2.8 – 4.2	S501UC-K4.2	250			2.8 – 4.2	S503UC-K4.2	712		
3.8 – 5.8	S501UC-K5.8	250			3.8 – 5.8	S503UC-K5.8	712		
5.3 – 8	S501UC-K8	250			5.3 – 8	S503UC-K8	712		
7.3 – 11	S501UC-K11	250			7.3 – 11	S503UC-K11	712		
10 – 15	S501UC-K15	250			10 – 15	S503UC-K15	712		
14 – 20	S501UC-K20	250			14 – 20	S503UC-K20	712		
18 – 26	S501UC-K26	250			18 – 26	S503UC-K26	712		
23 – 32	S501UC-K32	286			23 – 32	S503UC-K32	814		
29 – 37	S501UC-K37	286	29 – 37	S503UC-K37	814				
34 – 41	S501UC-K41	320	34 – 41	S503UC-K41	910				
38 – 45	S501UC-K45	320	38 – 45	S503UC-K45	910				
0.1 – 0.15	S502UC-K0.15	488	C	17.85	0.1 – 0.15	S504UC-K0.15	996	C	35.75
0.14 – 0.21	S502UC-K0.21	488			0.14 – 0.21	S504UC-K0.21	996		
0.2 – 0.3	S502UC-K0.3	488			0.2 – 0.3	S504UC-K0.3	996		
0.28 – 0.42	S502UC-K0.42	488			0.28 – 0.42	S504UC-K0.42	996		
0.38 – 0.58	S502UC-K0.58	488			0.38 – 0.58	S504UC-K0.58	996		
0.53 – 0.8	S502UC-K0.8	488			0.53 – 0.8	S504UC-K0.8	996		
0.73 – 1.1	S502UC-K1.1	488			0.73 – 1.1	S504UC-K1.1	996		
1 – 1.5	S502UC-K1.5	488			1 – 1.5	S504UC-K1.5	996		
1.4 – 2.1	S502UC-K2.1	488			1.4 – 2.1	S504UC-K2.1	996		
2 – 3	S502UC-K3	488			2 – 3	S504UC-K3	996		
2.8 – 4.2	S502UC-K4.2	488			2.8 – 4.2	S504UC-K4.2	996		
3.8 – 5.8	S502UC-K5.8	488			3.8 – 5.8	S504UC-K5.8	996		
5.3 – 8	S502UC-K8	488			5.3 – 8	S504UC-K8	996		
7.3 – 11	S502UC-K11	488			7.3 – 11	S504UC-K11	996		
10 – 15	S502UC-K15	488			10 – 15	S504UC-K15	996		
14 – 20	S502UC-K20	488			14 – 20	S504UC-K20	996		
18 – 26	S502UC-K26	488			18 – 26	S504UC-K26	996		
23 – 32	S502UC-K32	558			23 – 32	S504UC-K32	1142		
29 – 37	S502UC-K37	558	29 – 37	S504UC-K37	1142				
34 – 41	S502UC-K41	622	34 – 41	S504UC-K41	1276				
38 – 45	S502UC-K45	622	38 – 45	S504UC-K45	1276				

Pro M

Delivery Class

- A - Standard item, stock to 2 weeks lead time
- B - Stock to 4 weeks lead time
- C - 6 to 8 week lead time
- D - 10 to 12 week lead time
- E - Call for delivery

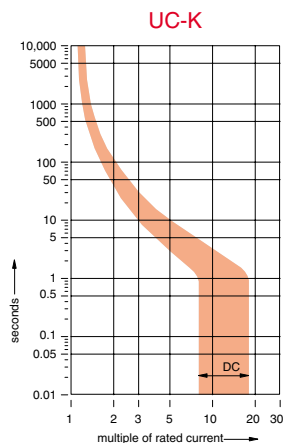



Accessories S500



S500-H11
Auxiliary contacts

www.DataSheet4U.com

Pro M

Electrical accessories	Catalog number	List price	Delivery class	Wgt. oz. (1pc.)
------------------------	----------------	------------	----------------	-----------------

Auxiliary contacts

1 N.O./1 N.C.	S500-H11	\$ 84	B	2.14
2 N.O.	S500-H20			
2 N.C.	S500-H02			

For field mounting left side

Bell alarm with auxiliary contacts

1 N.O./1 N.C.	S500-S11	92	B	2.14
2 N.O.	S500-S20			
2 N.C.	S500-S02			

For field mounting left side

Handle mechanism

	S500-RD3	100	B	6.5
--	----------	-----	---	-----

For use with 3 pole S500 MCBs and disconnect switch selector handles with 5mm shafts

Front mounting kit

For 1 pole	S500-ME1	16	A	2.1
1 to 3 poles	S500-ME2	32		2.9
1 to 7 poles	S500-ME3	64		3.6

Electrical accessories	Catalog number suffix	List price	Delivery class	Wgt. oz. (1pc.)
------------------------	-----------------------	------------	----------------	-----------------

Undervoltage release

12 V	-UA12	\$ 266	B	5.71
24 V	-UA24			
48 V	-UA48			
110 V	-UA110			
230 V	-UA230			
500 V	-UA500			

Factory mount only.

Shunt trip

12 V	-AL12	224	B	5.71
24 V	-AL24			
48 V	-AL48			
110 V	-AL110			
230 V	-AL230			
500 V	-AL500			

Factory mount only.

Delivery Class

- A** - Standard item, stock to 2 weeks lead time
- B** - Stock to 4 weeks lead time
- C** - 6 to 8 week lead time
- D** - 10 to 12 week lead time
- E** - Call for delivery

Technical data

S500



Item	S500-B, C, D	S500-K
Approvals: UL CSA VDE IEC	1077 C22.2 - No.235 0641/6.78 947-2	1077 C22.2 - No. 235 0641/6.78 —
No. of poles:	1,2,3, +N, +NA	1,2,3, +N, +NA
Tripping characteristic:	B.C.D.	K
Rated currents:	6 to 63A	0.1 to 45A
Rated voltage: UL/CSA single pole UL/CSA multi pole IEC single pole	277VAC 600VAC 690VAC	277VAC 600VAC 690VAC
Rated interrupting capacity: Single pole	6-25A – 30KA/240VAC 14KA/277VAC 32-63A – 18KA/240VAC 14KA/277VAC	0.15-25A – 30KA/240VAC 14KA/277VAC 26-45A – 18KA/240VAC 14KA/277VAC
Multi-pole	6-63A – 14KA/480VAC 6KA/600VAC	6-63A – 14KA/480VAC 6KA/600VAC
Frequency:	50/60 Hz	50/60Hz
Mounting position:	optional	optional
Standard mounting:	35mm DIN rail	35mm DIN rail
Terminals:	Conductors from 16-4AWG (1-25sq mm)	Conductors from 16-4AWG (1-25sq mm)
Service life at rated load:	20,000 operations	20,000 operations
Calibration temperature:	40°C	40°C

Item	S500UC-B, K																																																								
Approvals: UL CSA VDE	1077 C22.2 0660																																																								
No. of poles:	1,2,3, 4																																																								
Tripping characteristic:	B, K																																																								
Rated currents:	B: 6 to 63A K: 0.15 to 45A																																																								
Rated voltage: UL single pole UL multi pole IEC multi pole	277VAC/250VDC 600VAC/600VDC 690VAC/750VDC																																																								
Rated interrupting capacity:	<table border="0"> <tr> <td colspan="4">B single pole:</td> </tr> <tr> <td>6 – 25A</td> <td>18KA/240VAC</td> <td>14KA/277VAC</td> <td>30KA/250VDC</td> </tr> <tr> <td>32 – 63A</td> <td>30KA/240VAC</td> <td>14KA/277VAC</td> <td>30KA/250VDC</td> </tr> <tr> <td colspan="4">B two-pole:</td> </tr> <tr> <td>6 – 63A</td> <td>14KA/480VAC</td> <td>6KA/600VAC</td> <td>30KA/500VDC</td> </tr> <tr> <td colspan="4">B three-pole:</td> </tr> <tr> <td>6 – 63A</td> <td>14KA/480VAC</td> <td>6KA/600VAC</td> <td>30KA/600VDC</td> </tr> <tr> <td colspan="4">K single pole:</td> </tr> <tr> <td>0.15 – 25A</td> <td>30KA/240VAC</td> <td>14KA/277VAC</td> <td>30KA/250VDC</td> </tr> <tr> <td>32 – 63A</td> <td>18KA/240VAC</td> <td>14KA/277VAC</td> <td>30KA/250VDC</td> </tr> <tr> <td colspan="4">K two-pole:</td> </tr> <tr> <td>0.15 – 45A</td> <td>14KA/480VAC</td> <td>6KA/600VAC</td> <td>30KA/500VDC</td> </tr> <tr> <td colspan="4">K three-pole:</td> </tr> <tr> <td>0.5 – 45A</td> <td>14KA/480VAC</td> <td>6KA/600VAC</td> <td>30KA/600VDC</td> </tr> </table>	B single pole:				6 – 25A	18KA/240VAC	14KA/277VAC	30KA/250VDC	32 – 63A	30KA/240VAC	14KA/277VAC	30KA/250VDC	B two-pole:				6 – 63A	14KA/480VAC	6KA/600VAC	30KA/500VDC	B three-pole:				6 – 63A	14KA/480VAC	6KA/600VAC	30KA/600VDC	K single pole:				0.15 – 25A	30KA/240VAC	14KA/277VAC	30KA/250VDC	32 – 63A	18KA/240VAC	14KA/277VAC	30KA/250VDC	K two-pole:				0.15 – 45A	14KA/480VAC	6KA/600VAC	30KA/500VDC	K three-pole:				0.5 – 45A	14KA/480VAC	6KA/600VAC	30KA/600VDC
B single pole:																																																									
6 – 25A	18KA/240VAC	14KA/277VAC	30KA/250VDC																																																						
32 – 63A	30KA/240VAC	14KA/277VAC	30KA/250VDC																																																						
B two-pole:																																																									
6 – 63A	14KA/480VAC	6KA/600VAC	30KA/500VDC																																																						
B three-pole:																																																									
6 – 63A	14KA/480VAC	6KA/600VAC	30KA/600VDC																																																						
K single pole:																																																									
0.15 – 25A	30KA/240VAC	14KA/277VAC	30KA/250VDC																																																						
32 – 63A	18KA/240VAC	14KA/277VAC	30KA/250VDC																																																						
K two-pole:																																																									
0.15 – 45A	14KA/480VAC	6KA/600VAC	30KA/500VDC																																																						
K three-pole:																																																									
0.5 – 45A	14KA/480VAC	6KA/600VAC	30KA/600VDC																																																						
Frequency:	50/60Hz																																																								
Mounting position:	optional																																																								
Standard mounting:	35mm DIN-rail																																																								
Terminals:	Conductors from 16 to 4AWG (1-25sq mm)																																																								
Service life at rated load:	20,000 operations																																																								
	40°C																																																								

Pro M



Approximate dimensions S500 Accessories

00.00 Inches
00.00 Millimeters

S500

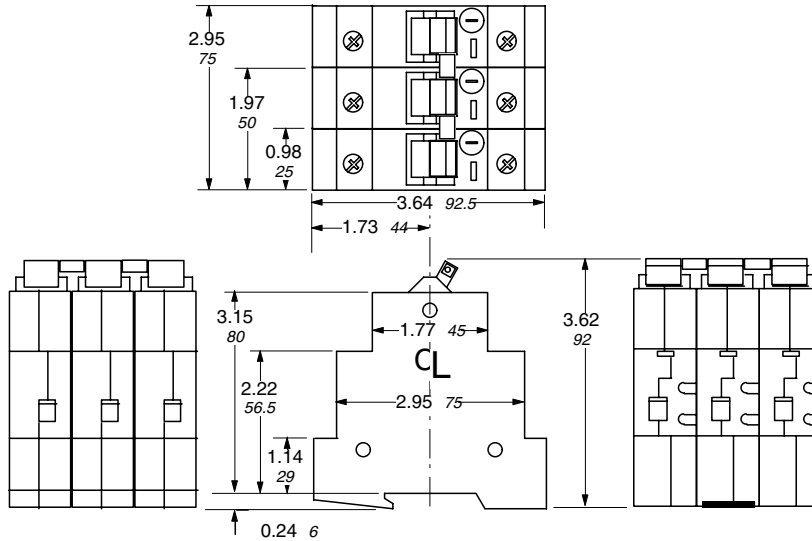

www.DataSheet4U.com

Pro M

S500-RD3 Handle mechanism

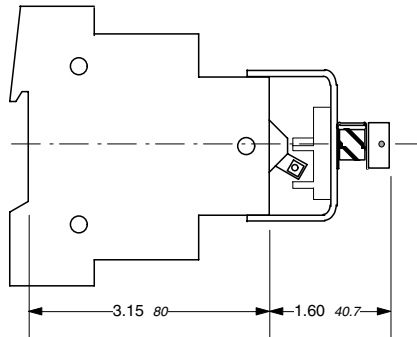

S500 Front mounting kit

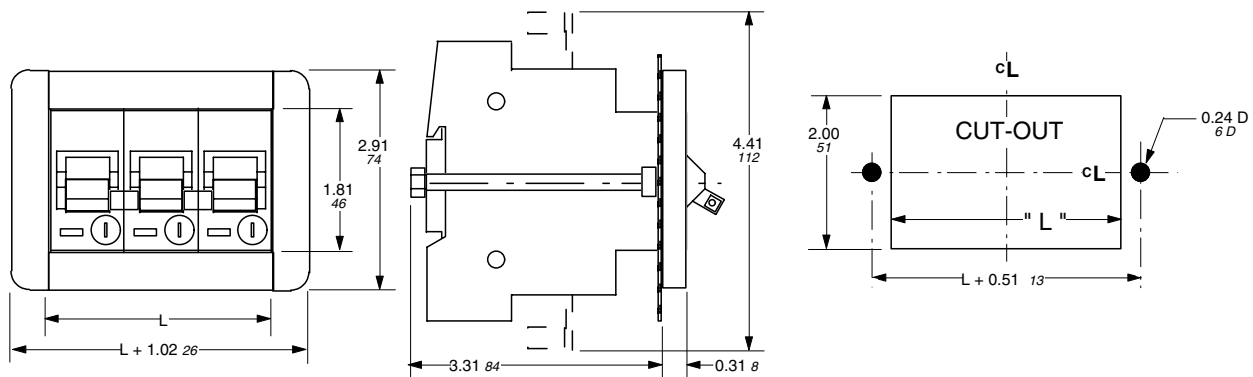



Residual current devices F360 series

www.DataSheet4U.com

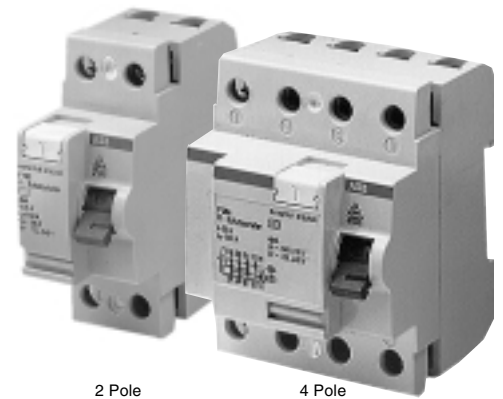

2 Pole

4 Pole

Pro M

Description

RCDs provide ground fault equipment protection by monitoring the leakage of current to ground. The F360 series will trip when ground faults are detected in excess of the GF trip rating of the RCCB. These devices provide GF protection only and are used in series with standard MCBs which provide overload and short circuit protection. The F360 series can be used as a main device providing GF protection for several MCB branch devices.

The F360 series are UL1053 recognized for use in 277/480VAC applications.

The F362 is for use in single phase/two wire or two wire systems. The F364 is for use in three phase/four wire systems.



Selection guide

Residual current devices, F362, F364

00.00 Inches
00.00 Millimeters



F262



F364

Residual current breakers

Breaker	GF trip level	Rated current	Catalog number	List price	Delivery class	Suggested order qty	Wgt. oz (1 Pc.)
F362 Two pole 480VAC	10mA	16	F362-16/0.01	\$ 590	B	1	13.8
		25	F362-25/0.03	408			
		40	F362-40/0.03	464			
		63	F362-63/0.03	660			
	100mA	25	F362-25/0.1	408			
		40	F362-40/0.1	464			
		63	F362-63/0.1	660			
	300mA	25	F362-25/0.3	288			
		40	F362-40/0.3	320			
63		F362-63/0.3	474				
F364 Four pole 480VAC	30mA	25	F364-25/0.03	426	B	1	19.0
		40	F364-40/0.03	486			
		63	F364-63/0.03	726			
	100mA	25	F364-25/0.1	426			
		40	F364-40/0.1	486			
		63	F364-63/0.1	726			
	300mA	25	F364-25/0.3	302			
		40	F364-40/0.3	342			
		63	F364-63/0.3	494			
	500mA	25	F364-25/0.5	302			
		40	F364-40/0.5	342			
		63	F364-63/0.5	494			

Above devices are UL 1053 recognized and IEC 1008 approved.

Delivery Class

- A - Standard item, stock to 2 weeks lead time
- B - Stock to 4 weeks lead time
- C - 6 to 8 week lead time
- D - 10 to 12 week lead time
- E - Call for delivery

Approximate dimensions

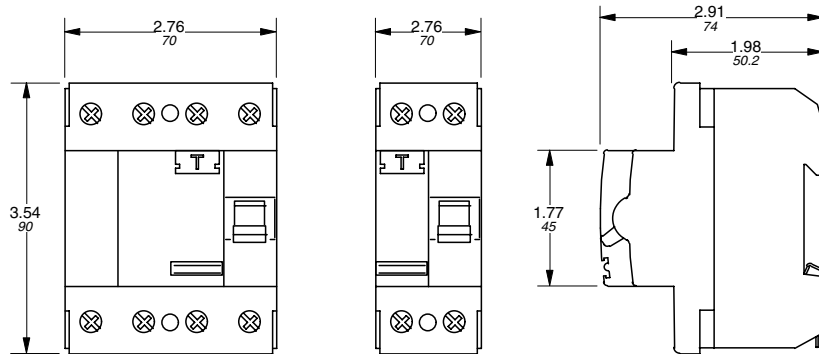

Wiring diagram

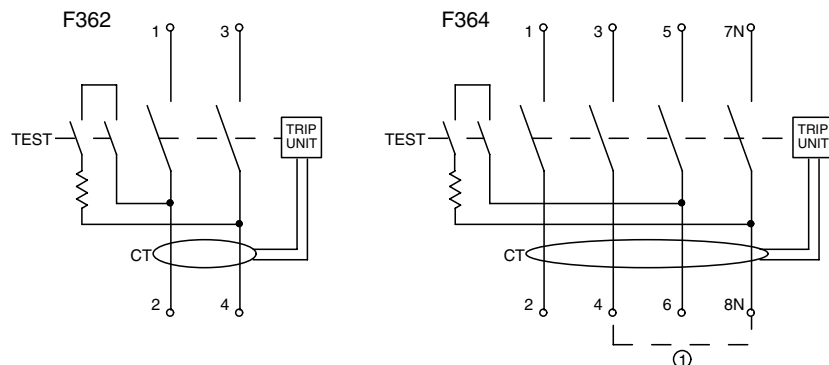

① For use on 3p/3w systems, add jumper between 4 and 8N for operation of test button.



Modular installation equipment System Pro M

www.DataSheet4U.com

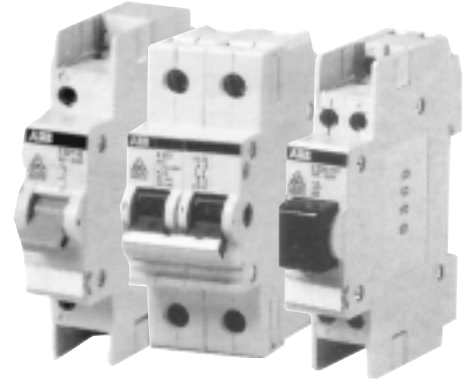

Pro M

Description

- Safe connection by box terminals
- Captive screws with Pozidrive slotted head, Pozidrive system, Gr. 1
- Snap-on labels available
- Quick mounting with snap-on clip, easily accessible and detachable at the bottom
- Protection against unintentional direct touch
- System approach for control and circuit protection
- Compact size that dimensionally matches the S2 MCB series
- Control and pilot functions can be along side protective devices
- DIN rail mounted with 45mm front opening
- For use in auxiliary and logic devices
- Provide additional user functions for system control and operation
- Include pushbuttons, indicating lights and selector switches
- ABB System Pro M compatibility
- Most devices are both UL 508 recognized and are IEC compliant
- Labeled with the CE Mark



Modular installation equipment

Switches, 240VAC

16 & 25A



E221-10

www.DataSheet4U.com

Pro M

Type	Rated current	Catalog number	List price	Delivery schedule	Suggested order qty's	Weight (Oz.) 1 piece
Switches						
1 N.O. + 1 N.C.	16	E221-11	\$ 90			
2 N.O. + 2 N.C.	16	E221-22	177	B	10	2.46
3 N.O. + 1 N.C.	16	E221-31	177			
1 N.O.	16	E221-10	59			1.94
2 N.O.	16	E221-20	110	B	10	2.12
3 N.O.	16	E221-30	120			2.29
4 N.O.	16	E221-40	159			2.47
1 N.O. + 1 N.C.	25	E222-11	140			2.47
1 N.O.	25	E222-10	107	B	10	1.94
2 N.O.	25	E222-20	141			2.12
3 N.O.	25	E222-30	159			2.29
4 N.O.	25	E222-40	239			2.47

Form "C" switches

1 Change-over contact	16	E221-6	69	B	10	2.12
2 Change-over contacts	16	E221-6/2	125			2.47
1 Change-over contact	25	E222-6	128	B	10	2.12

Form "C" switches (I-O-II, Hand-OFF-Automatic)

1 Pole	16	E221-4	99	B	10	2.12
2 Pole	16	E221-4/2	147			2.47
1 Pole	25	E222-4	150	B	10	2.12

Note: Above devices are UL 508 recognized and IEC certified.
A300 pilot duty

Delivery Class

- A - Standard item, stock to 2 weeks lead time
- B - Stock to 4 weeks lead time
- C - 6 to 8 week lead time
- D - 10 to 12 week lead time
- E - Call for delivery

Modular installation equipment

Disconnect switches

45, 63, 80 & 100A



Single pole



Two pole

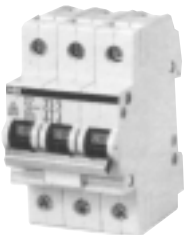

Three pole

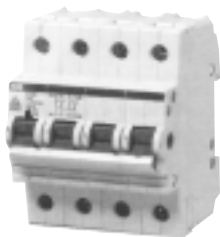

Four pole

Type	Rated current	Catalog number	List price	Delivery schedule	Suggested order qtys	Weight (Oz.) 1 piece
Single pole, 240V	45	E241/45	\$ 54	B	10	2.82
	63	E271/63	60			
	80	E271/80	72			
	100	E271/100	96			
Two pole, 415V	45	E242/45	114	B	5	6.17
	63	E272/63	126			
	80	E272/80	150			
	100	E272/100	204			
Three pole, 415V	45	E243/45	174	B	3	9.52
	63	E273/63	192			
	80	E273/80	228			
	100	E273/100	306			
Four pole, 415V	45	E244/45	234	B	2	12.87
	63	E274/63	258			
	80	E274/80	306			
	100	E274/100	410			

Above devices are IEC certified.

Isolator switches

The E240/270 series operate as disconnect switches and are typically used as a main disconnect for several branch MCB devices. The isolator switches offer no overcurrent protection. The E240/270 series is the same physical size and shape as the S260, S270 & S280 series. The switches include dual function terminals and can be connected via standard ABB busbar through the upper or lower terminals.

Delivery Class

- A** - Standard item, stock to 2 weeks lead time
- B** - Stock to 4 weeks lead time
- C** - 6 to 8 week lead time
- D** - 10 to 12 week lead time
- E** - Call for delivery

Pro M



Modular installation equipment

Pilot devices

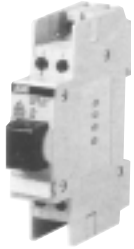

E225-11F



E227-10E

www.DataSheet4U.com

Pro M

Type	Catalog number	List price	Delivery schedule	Pack units pcs.	Weight (Oz.) 1 piece
Pushbutton, 1 N.O. + 1 N.C. contact					
Grey	E225-11B	\$ 75	A	10	1.94
Red	E225-11C				
Green	E225-11D				
Yellow	E225-11E				
Black	E225-11F				
Blue	E225-11G				

Illuminated pushbutton, 1 N.O. contact with lamp, 120 VAC					
Clear	E227-10B/110	100	A	10	1.94
Red	E227-10C/110				
Green	E227-10D/110				
Yellow	E227-10E/110				
Blue	E227-10G/110				

Pilot light with lamp, 120 VAC					
Clear	E229-B/110	93	A	10	1.59
Red	E229-C/110				
Green	E229-D/110				
Yellow	E229-E/110				
Blue	E229-G/110				

Lamps					
24 VAC/DC	E10/24	24	A	1	0.14
120 VAC/DC	E10/110				
220 VAC/DC	E10/220				

Note: Above devices are UL 508 recognized and IEC certified.

Special features

- Safe connection via box terminals
- Captive screws with Phillips/Slotted head, Posidriv system, Gr. 1
- Snap-on labels available
- Protection against unintentional touch acc. to DIN VDE 0106 Part 100
- Lenses and pushbuttons in six colors

Elapsed time meter

Type	Catalog number	List price	Delivery schedule	Pack units pcs.	Weight (KG) 1 piece
24 VAC, 60 Hz	E233-24/60	\$ 130	B	1	0.045
120 VAC, 60 Hz	E233-120/60		A		
240 VAC, 60 Hz	E233-240/60		B		

- Non-resettable
- 100,000 hours (99999.99)

Delivery Class

- A - Standard item, stock to 2 weeks lead time
- B - Stock to 4 weeks lead time
- C - 6 to 8 week lead time
- D - 10 to 12 week lead time
- E - Call for delivery

Modular installation equipment

Technical data



Components for quick mounting onto DIN rails (35mm)
 Mounting depth: 68mm
 Mounting width: 1, 2, 3 and 4 pole switches = 17.5mm (= 1 module)

E220 Switches, 16 & 25A

Switching capacity: $1.25 I_n, 1.1 U_n, \cos \phi = 0.6$
 Short-circuit withstanding capacity: 3 kA, 380V, $\cos \phi = 0.9$
 Toggle sealable: In ON and OFF positions
 Connection cross-sections: Up to $1 \times 6\text{mm}^2$ or $2 \times 2.5\text{mm}^2$
 Rated AC voltage: 240 VAC UL/CSA (E171252)
 250/440 VAC IEC

E240/270 Disconnect switches, 45, 63, 80, & 100A

Switching capacity: $1.25 I_n, 1.1 U_n, \cos \phi = 0.3$
 Short-circuit withstanding capacity: E240 = 10kA, E270 = 25kA RMS
 Connection cross-sections: E240 up to 25mm^2
 E270 up to 50mm^2
 Rated AC voltage: 240/400/415 VAC

E Series components for quick mounting onto DIN rails (35mm)

Mounting depth: 68mm
 Mounting width: 17.5mm (=1 module)
 Color: RAL 7035, grey
 Connection cross sections: Up to $1 \times 6\text{mm}^2$ or $2 \times 2.5\text{mm}^2$
 Rated current: 16A
 Rated voltage: 250 VAC IEC
 Rated voltage: 240 VAC UL/CSA (E171252)

Terminal markings

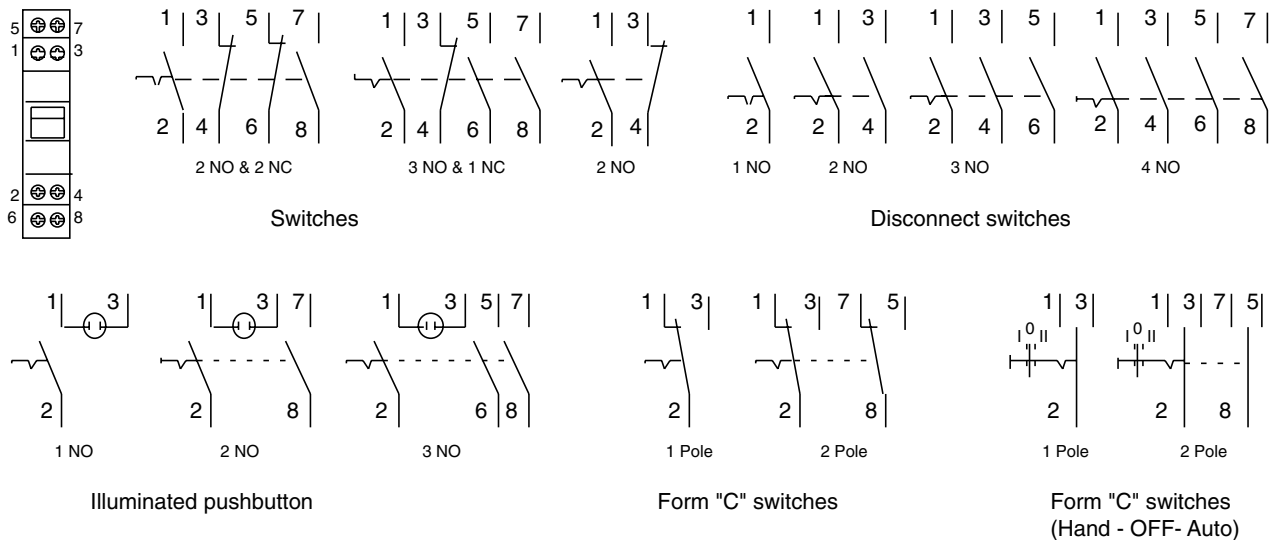

Terminal assignments for pushbuttons and indicator lights

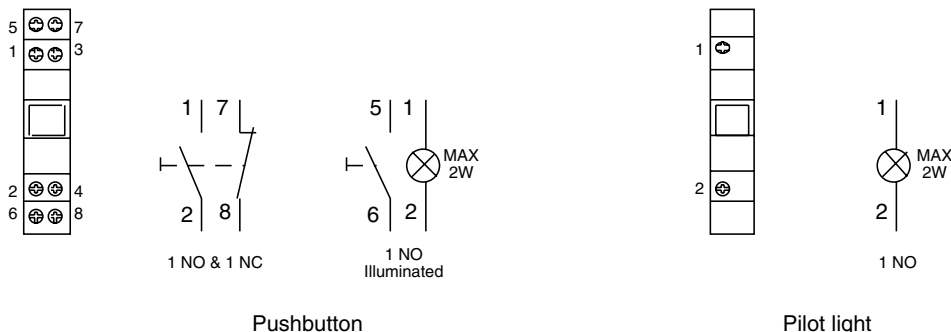

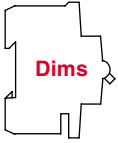

Modular installation equipment

Approximate dimensions

← 00.00 → Inches
00.00 → Millimeters

E220

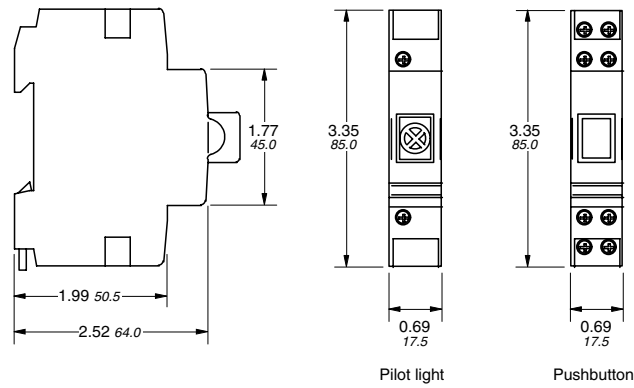

www.DataSheet4U.com

E220, 16 & 25A

Pro M

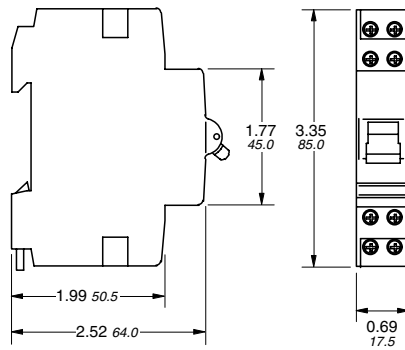

E233

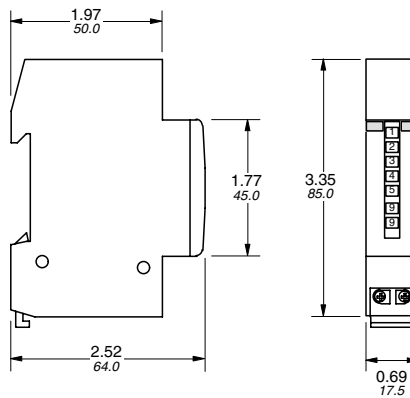

E240/270

